

The Dragon

#25

\$2.00
Vol. III No. II
May, 1979

Gamma World
An Alien in a
Strange Land

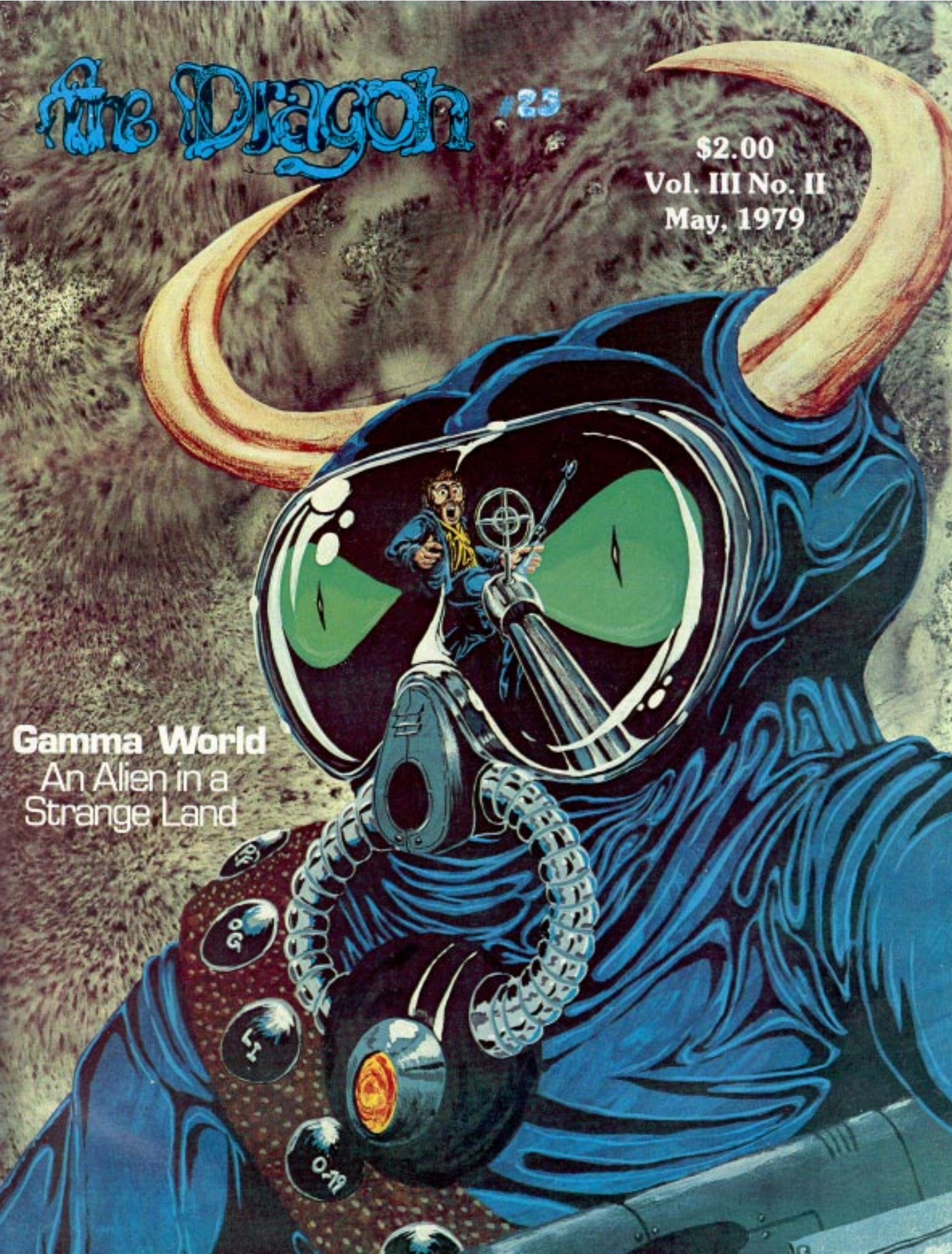

The Army of
MU'UGALAVYA
from

RAL PARTHA



M-5



M-7
GENERAL



M-1

MU'UGALAVYA

- M-1 HEAVY INFANTRY SPEARMAN
- M-2 MEDIUM INFANTRY, WARHAMMER
- M-3 MEDIUM INFANTRY, SPEARMAN
- M-4 HEAVY INFANTRY, AXE
- M-5 ARCHER
- M-6 SLINGER
- M-7 COMMAND GROUP



M-4



M-2



M-6



M-3

For a complete catalog, send 25 cents in stamp or coin to

RAL PARTHA ENTERPRISES

3726 LONSDALE • CINCINNATI, OHIO 45227 • 513-271-4230

4TH DIMENSION

THE GAME OF TIME & SPACE



You are a mighty Time-Lord, and your powerful army of Guardians, Rangers, and Warriors stands ready to do battle. Your opponent is equally strong, and knows that only one of you will survive this conflict of time and space; for you both are Time-Lords, able to alter the fabric of reality, and there is room in the universe for only one with such power . . .

4TH DIMENSION is a classic game of pure strategy — no luck or dice are involved. A unique feature of the game is the ability to “Time-Warp” a piece — removing it from the board — and bringing it back into play in a different location! Players must take care not to allow their Time-Lords to be trapped by opposing Warriors beaming down from Time-Warp . . .

Simple to learn, 4D is easily grasped by any gamer from age 10 to adult. The rules are brief and fully illustrated with examples of play; it takes only about 15 minutes to read them and start playing. Games typically are over in only 30-45 minutes.

This deluxe boxed version of the game comes complete and includes a 8³/₄” x 10¹/₂” mounted gameboard, a set of 26 custom molded plastic playing pieces, and a four-page rules folder.

When 4TH DIMENSION was first released in Britain a few years ago, it became an instant success. Local clubs were formed to play the game as well as the 4D Society which publishes its own newsletter and sponsors regular meetings and tournaments. TSR is proud to present the American edition of this excellent game — another fine product from TSR, The Game Wizards!

\$9.95



THE DUNGEON HOBBY SHOP
772 Main St.
Lake Geneva, WI 53147

Please add \$1.00 to all orders
regardless of size for postage
and handling.

U.K. Pat. #74/40198
U.S. Pat. #4019740



— The Magazine of Fantasy, Swords & Sorcery, and Science Fiction Game Playing—



VOL. III, No. 11 May, 1979

DESIGN/DESIGNER'S FORUM

| | |
|--|----|
| A Part of Gamma World Revisited—Jim Ward | 5 |
| Judging and You—Jim Ward | 7 |
| Sorcerer's Scroll—The Proper Place of <i>Character</i> <i>Social Class in D&D</i> -- Gary Gygax | 12 |
| 20th Century Primitive—Gary Jacquet | 24 |
| Gamma World Artifact Use Chart—Gary Jacquet | 24 |
| To Select a Mythos—Bob Bledsaw | 43 |

FEATURES

| | |
|--|-------|
| Out on a Limb | 14 |
| Will the Real Orc Please Step Forward—Lance Harrop | 18 |
| Gamma World Map Pull Out | 23-26 |

FICTION

| | |
|---|----|
| The Tug of Machine—Allen Evans | 8 |
| An Alien in a Strange Land—Jim Ward | 28 |

VARIANTS

| | |
|--|----|
| The Traveller Navy Wants to Join You—R.D. Stuart | 20 |
| Varieties of Vampires—R.P. Smith | 42 |

HUMOR

| | |
|--|----|
| Excerpt From an Interview with an IRON Golem --Mike McCreery | 31 |
| Fineous Fingers—J.D. Webster | 41 |

BACKGROUND

| | |
|--|----|
| The Armada's Disasters—Lynn Harpold | 9 |
| Armies of the Renaissance—Nick Nascati | 17 |
| Flower Wars—Bill Fawcett | 35 |
| Xochiyaoyotl—Rules for Pre-Hispanic Mexican Warfare—Neal M. Dorst | 37 |
| Arms and Armor of the Conquistadores—Mike H. Kleuvor | 44 |

NEWS

| | |
|----------------------------|----|
| Convention schedules | 11 |
| GENCON XII Update | 33 |

If your mailing label says TD25, this is your last issue . . . resubscribe.

A non-wargaming friend of mine recently asked me why I did this; why did I put all my effort into this line of work? What did I perceive my endeavors to be?

Part of this curiosity stems from the fact that this person has no inkling of what games are all about, in our context of gaming. He still clings to the shibboleth that wargamers are classic cases of arrested development, never having gotten out of the sandbox and toy soldiers syndrome of childhood. He couldn't perceive the function of a magazine about game-playing. This is what I told him:

Magazines exist to disseminate information. The future of magazine publishing, the newly revived *LIFE* and *LOOK* notwithstanding, seems to be in specialization. Magazines dealing with camping, quilting, motorcycles, cars, dollhouse miniatures, music, teen interests, modeling, model building, horses, dogs, fishing, hunting, guns, hairstyling and beauty hints already exist; why not wargaming?

I put out TD as a forum for the exchange of gaming ideas, philosophies, variants and debate. TD is a far cry from *Soldier of Fortune*, that bizarre publication for mercenaries, gun freaks and other violence mongers. In fact, the greater part of wargamers are quite pacifistic in "real life."

I feel that during my tenure, TD has done rather well on most of those counts, but failed miserably in one function. To judge from the mail I read, TD must have the most brilliant group of controversy, and no commentary. Early on in our publishing life, we had a letters page that died for lack of participation. Two issues ago, we revived it. I use that word "revive" guardedly, because it might as well be still dead, judging from the response it has failed to generate. As I write this, I have serious doubts as to whether or not there will be a letters page in upcoming issues, as I have received none to speak of. This is the best and only chance the readers are going to get to make their thoughts known; let's hear from some of you.

CLARIFICATION

Special Note: Lest readers be confused about the past review of the fan publication, PHOENIX, I wish to make it clear that this is not the English magazine, THE PHOENIX, a professional journal of high standards well worth the time to read (and incidentally printed well so it can, in fact, be read).

A PART OF GAMMA WORLD

REVISITED

James M. Ward

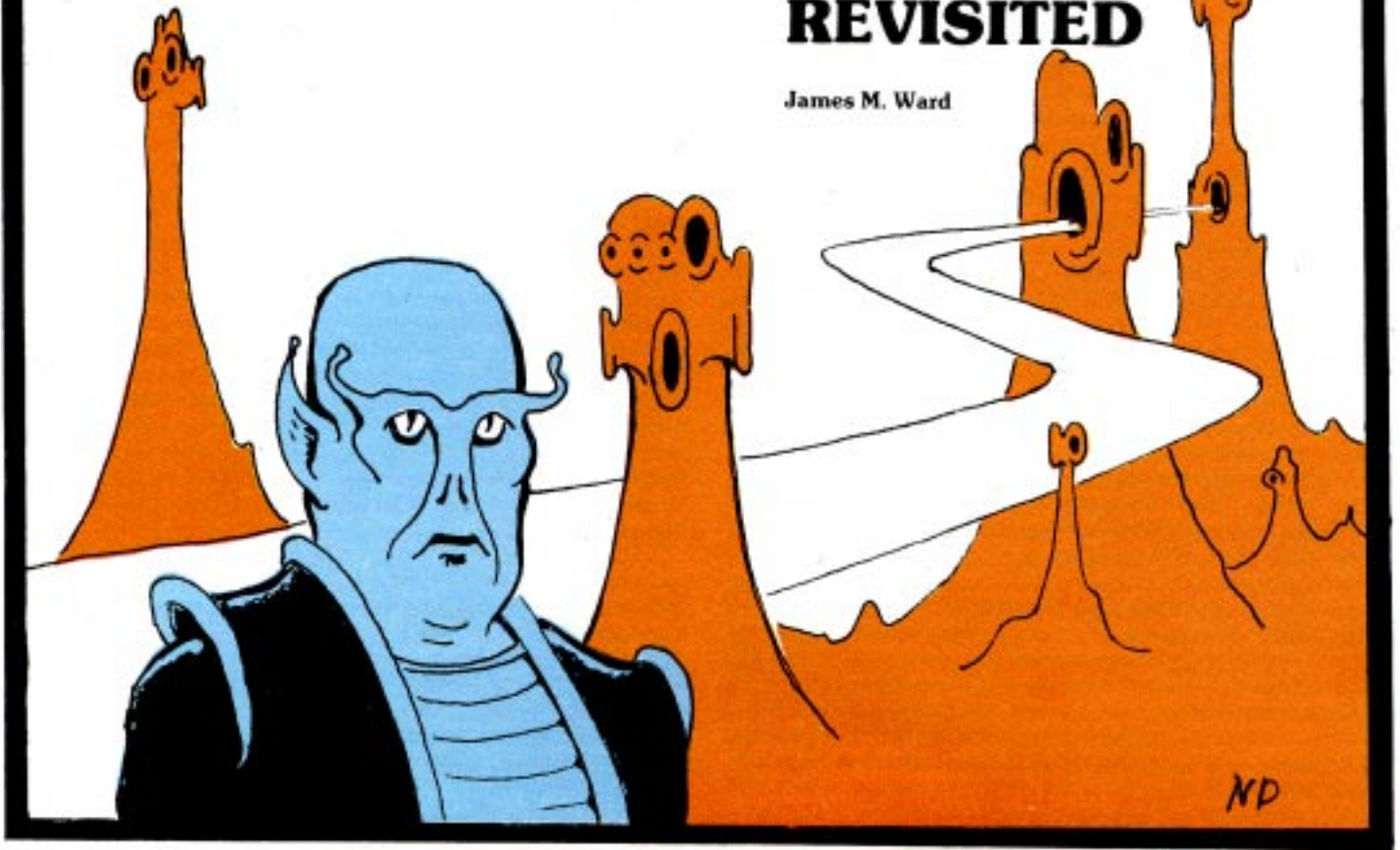

For any role playing game to be really effective, it is vital to create some basic premise for any non-player group. The Cryptic Alliances are tailor-made for any large campaign and to briefly jot down the creation and present situation as well as the direction the alliances will be taking is a good move.

The "*Brotherhood of Thought*" was started by a biochemist from the University of California that was putting the finishing touches on an ecological monitoring station in the mountains near the university. The time of the "great destruction" pulverized the campus while Dr. Dotson and two assistants were at the station. The years afterward were a matter of survival for the three. Within months, animals of all different types began to flock to the station for the pure well water its pumps could bring up to the surface. The scientific interest of the three couldn't help noticing the change brought about in the thirsty creatures and this interest was intensified when several groups of animals followed unspoken directions from them, and thus revealed their telepathic powers. Long years of work and a specialized breeding program brought about several species of animals of human or better intelligence. The years went by and that biochemist and his assistants had sons and daughters that carried on their work. Because of this all humanoid or animal followers of this group have an inordinate fondness for humans. They spread up and down the west coast and into the Rockies. The groups of three came from an animalistic imitation of what they saw in their first leaders. The group presently is run by the following beings:

ELENOR: 5th generation granddaughter to the first biochemist, MS: 18, I: 18, D: 17, Ch: 18, C: 18, S: 16, Hit Points 91; uses a Black Ray Gun, Stun Rifle, Medi-kit, and Plastic Armor.

CRISPT: 19th generation Gren, MS: 17, I: 18, D: 18, C: 18, S: 18, Hit Points 131; uses a longbow with 18 intensity poison arrows, 2 daggers of duralloy, Armor Class: 4.

POSHT: 23rd generation Brutorz: this being is the genius of all of its kind and surprises all who must deal with it; MS: 18, I: 18, D: 18, C: 18, S: 18, Hit Points 82, Armor Class: 7, and it has the following physical and mental attributes: Heightened Vision, Increased Speed, Radiated

Eyes, Regeneration, Mental Control, Pyrokinesis, Repulsion, and Telepathy. This group roams with others and recruits beings for the "Brotherhood" leading them to the original station (now much expanded).

The "*Seekers*" group began around a nucleus of Texans who were camping out near Lubbock on the range when the time of the "great destruction" hit their area. Their range skills allowed them to begin again with ease. As time went by and mutants started entering the area, humanoids and mutated animals were treated as gruesome vermin to be wiped out with maximum force. Mutants that were "completely" human in appearance were accepted as "unusually" talented partners in a battle for survival. Currently the group is led by Tral-Vash, a human of unusual power: MS: 8, I: 18, D: 18, Ch: 17, C: 18, S: 10, Hit Points 99; he uses a Fusion Rifle, Energy Mace, and Powered Scout Armor. Armories have been raided so that the group has a vast supply of weapons and vehicles. The leader doesn't favor expansion, he wants to create a solid nation of warriors working for several generations to accomplish this goal.

The "*Knights of Genetic Purity*" evolved from a large group of humans that survived the war, but were dusted with radiation. From that time on, for generation after generation, horrible mutations were created and these were all killed. By the third generation of this grief and sadness a leader arose who moved to end this blight on his race. He created an organization willing and able to breed out all racial defects. They took this one step further in that they began killing all humanoids wherever they found them, even to the point of searching them out far from their home territory. This organization honored those who could recover lost technology and thus they have grown strong in physical power. Their leader has the following statistics: SEVEREN: MS: 3, I: 15, D: 18, Ch: 18, C: 17, S: 18, Hit Points 100, he uses a Mark 7 Rifle, a Stun Whip, and Powered Assault Armor. He and three others, armed as himself, often travel out destroying strong pockets of mutant strength.

The "*Friends of Entropy*" are gruesome beings worshipping death from the very beginning, when a quasi-religious cult survived in the

intact state from the time of the "great destruction." The initial group started out simply wanting to kill all animal life around them (forcing them to move often). As they ate contaminated flesh and traveled through radiated areas their offspring begin to mutate rapidly. These newer generations caused the cult to modify its thinking in the desire to kill all life. The current co-ordinator of the group is a humanoid mutant named Blern. This creature is the ultimate model for the cult. At birth, when his flesh was exposed to the air a poison gas was given off, killing his mother and the attending midwife. His proud father designed a uniform for him so that he could travel with all the rest. On reaching maturity, he further mutated: growing a pair of horns, requiring tinted goggles to travel during the day, and having to breathe through a special filter to extract all pollen elements from his air. He also increased in mental and physical powers including some powers totally unknown until then: MS: 18, I: 18, D: 10, C: 18, S: 7, Hit Points 104; he uses a Mark V Blaster, Mark 7 Rifle, a Vibro Blade, several Torc Grenades, an Energy Cloak, and a Medi-kit especially designed for his needs (it would kill anyone else). His mutational abilities include: Gas Generation (intensity 18 poison), Heightened Balance, Dexterity, Precision, & Touch, Radiated Eyes, Sonics, Dual Brain, De-evolution, Force Field Generation, Heightened Brain Talent, Life Leech, Mental Control, Telepathy, the ability to magnify by a factor of 3 any blast from *any type* rifle or pistol he uses, and the ability to communicate with any intelligent machine so that the machine is fooled into thinking anything Blern wishes.

He quickly forced his way to the leadership of the Society and established a permanent base near what used to be Lincoln, Nebraska and the group grew in power. He soon became bored with the problems faced with keeping the ghastly cultists together and he set up an administration that ran the group and started roaming far and wide terrorizing other society groups. His methods are always the same. He enters the area and nightly destroys either important crops or domesticated animals. If he is chased by beings with little or no technology, he runs away, just letting them see him and continuing his raids until the angered populace either brings up large numbers of attackers or heavy duty technology. He then faces his attackers using his weapons; both technological and mutative (as in the cover of this magazine when 23 Seekers dared to face him with power weapons and the last one is seen trying to run).

The "*Iron Society*" has no known base, but can be found near any large bombed area. The very nature of the energy nearby creates a psychological condition in all intelligent creatures nearby that forces them to want to destroy any beings not as they (highly resistant to radiation). 95% of all of these groups are totally resistant to all forms of energy weapons, while easily able to use such themselves.

The "*Zoopremists*," starting in the fertile Mexican mountain range below Torreon, tested the theory of survival of the fittest to its maximum limits. Here, insects grew larger and highly intelligent and started logically moving against all other intelligent life forms. In this struggle they forceably domesticated some of the most prevalent mutants and these they use as spies. Co-ordinated attacks are always made against large groups holding technology. The whole organization is led by a giant (20 feet long) drone ant with the following statistics: MS: 18, I: 13, D: 12, C: 18, Hit Points 189, Armor Class: 2: it has Heat Generation, Heightened Touch, Increased Speed, Photosynthetic Skin, Absorption Heat & Radiation, Military Genius, Life Leech, and Telepathy. This creature always personally scouts any large alien group to be attacked, and he takes 10 neuter ants for support (pincers do 4-40 per strike, 20 dice each, Armor Class: 2).

The "*Healers*" began life as a group near Duluth, Minnesota by a number of med-technicians that had been working on sleep therapy and accidentally made a vast break through in artificial telepathy through electrode induction. Their organization quickly gathered all the survivors in the area and efficiently went about living. Their Hippocratic oath soon became translated into helping all intelligent and unintelligent creatures survive in a world gone wild. The telepathic powers developed grew in magnitude over the century and helped the Healers sense all life in a 1 mile radius and influence the actions of any non-sentient beings in numbers up to 10. They range far down into the south and east, healing where possible, teaching others to help themselves, and sending calm beings to their main base for advanced training.

"*Restorationists*" survived in shelters in Boston and Providence. They crawled out of their areas and tried to pull the pieces together from

the rubble cities around them. They grew in strength and were well organized by the time mutated creatures started entering their area. They were able to react with considerable force in the way of technological capability. All of their towns and farms are guarded by robotic units that are programmed to kill humanoids and mutants without warning and conduct humans to the main city. There are 5 town groups that each have an armory manned with men capable of using the powered armor and weapons at hand; a factory unit programmed to manufacture their everyday needs; and a group of robots designed to cannibalize the old cities for materials the smaller groups need. In the town near Manchester, their leader (Mayor), realizing the closed nature of their culture, has forced his citizens to work to create new technology on the basis of the old. He is a mutant (but no one, not even himself, is aware of that fact): MS: 18, I: 18, D: 12, Ch: 15, C: 18, S: 11, Hit Points 88, and the following mental powers: Military, Scientific, and Economic Genius, and Total Healing.

The "*Followers of the Voice*" are usually successful in their efforts to gather technology because they follow insane computer units that use their programs to tell their followers where to go. The most successful group has a strong underground base in the Appalachians south of Charleston and west of Raleigh. This group all have Laser Rifles and Laser Pistols. Their leader is a Hoop, who, besides her normal features, has the following abilities: Heightened Balance, Constitution, Hearing, Precision, and Smell, Increased Speed, and Shapechange All. She also has 120 Hit points and constant advice from a Think Tank buried in their caverns.

The "*Ranks of the Fit*" began near Memphis, Tennessee; when a circus bear had its mental abilities boosted a thousand times by an unusual radiation blast. This creature suddenly had every good mental mutation on the list, and a bunch more not given. It was the only intelligent creature to survive in the city and it went about learning what man's civilization was like. Armed with this knowledge, it began a civilization that has spread to Cincinnati and the shores near the sunken city of Baton Rouge. Its grandson now rules and also has all of the mental powers listed plus the following: MS: 18, I: 16, D: 15, Ch: 17, C: 18, S: 18, Hit Points 210, and an Armor Class of 2. His power is immense and in the form of 10 armies that are 50,000 strong. He places them about his empire and uses them to destroy pockets of mutant resistance or as heavy duty manpower forces to extend his empire.

The "*Archivists*" are zealots set up in the mountains between the cities of Butte, Montana, Billings, South Dakota, and Idaho Falls, Montana. They are all cave dwellers that have made miles-long tunnels that connect all of these cities. They have been able to figure out the workings of thousands of earth movers and are in the process of covering up these partially ruined cities for their underground use. While their main base is in the mountains, they have scouted all of the cities from Seattle to Dallas. Their leader is a Fen, who organizes defenses of high technology around his main base and the more important bases they are tying to cover.

The "*Radioactivists*" are almost entirely based below Atlanta in the flattened peninsula that was part of Florida. Its members are all totally resistant to radiation and have seen over and over again what the power of the atom can do to damage life. As a result, they are sowing the edges of their territory with radioactive dust obtained from the interior of their lands. Their leaders are a group of 5 Keeshin that travel on the edges of the territory directing dusting efforts.

The "*Created*" are predominately androids. They were started into life by a med-technician who saw his civilization crashing around him and wanted to give the androids that were under his control a chance to "live." He set his computers on random programming and turned his back on the whole complex (only to die minutes later as a building fell on him). From that time on, the androids that were created programmed their new brothers and started rounding up technological power. At this time they have completely encircled the town of St. Louis with war robots and have rebuilt it to what it was before the time of the "great destruction." The only being that ever successfully invaded their area was Blern and he destroyed their primary Think Tank as a lark and reprogrammed all of the thinking units of the city to ignore Entropy beings.

Note: Special thanks should be given to Brian Blume, who supplied the locations of all of the circled cities by careful comparisons.

Judging and You!

BY JAMES M. WARD

It is easy to say (or write, in this case) that you as a "Planet Master" or "Starship Master" are the final arbiter in your campaign game, but, let's face it; there are bunches of bad judges out there because they have a flaw of one type or another. There are several tricks to the judging trade that I have seen and started; I know several of the bad judges I have seen could profit from them.

One of the first things that any new judge must think about is what they are interested in developing in their games. I, as a judge, am not interested in how my players get their daily food (so game is plentiful in all my areas) .I am not overly interested in equipment maintenance and breakdowns because my game is extremely destructive. I am not interested in a strict interpretation of the rules for weapons function or the intermixing of cryptic alliances, so I freely change what has been written down. On the other hand, I *am* highly interested in the non-player character and as a result there are many roaming around my *Gamma World* in many shapes and sizes. I *am* interested in the creation of new mutants and groups so this is an ongoing process that gets new groups constantly moving over the ruined earth.

Many people have asked me how I create my maps and encounter areas and usually give me a puzzled look when I try to explain. My biggest tool in the creation and use of any *Gamma World* society, city, building, or hole in the ground is improvisation. I (and many like me all over the place) have not got the time nor the inclination to sit down and write pages and pages of detailed description on what a building looks like and what is inside. The notes I jot down for any given encounter area are very vague as to what things look like and what is contained inside.

At one Origins convention I was running a *Gamma World* tourney and the group ran into an armory in a bombed out city. All I had listed was that fact that it was an Armory and the war machines that were inside it, those being: 2 security robots, 2 engineering bots (HD), 2 medical robotoids, 1 supervisory borg, a think tank in the basement, 2 war-bots, a death machine, and several different types of military vehicles. From then on I improvised the whole thing. My Father works in a National Guard Armory and when just a boy I used to take great pride in putting up the units flag before I went to school and collecting a bottle of pop for my efforts (this gave me a very exact knowledge of what that armory looked like); from this experience I was able to exactly detail every room that the group entered and what was inside it (updated to what I thought was the 21st century's equivalent). They therefore had a choice of entering from a side door that led to the firing range; a side door that led to the kitchen; a side door that led to the motor pool; the large front doors; or a side door that was near the boiler room. After coming in the firing range side door and doing things with the security robot that faced them, I could tell them exactly where the supply room or the communications room was in relation to where they stood at the door. None of this was written down but they didn't know that and it all worked out great. My point is that you should use the very familiar things of everyday life instead of huge piles of detailed description that you have to ply through as well as your players. So what if I didn't know exactly how many pairs of boots were in the locker room or how many shovels or gas masks were in the supply room? I *did* know how many of each I wanted the group to get away with, and that's what I told them. This same concept can apply to everything any referee must play with.

If I am working with a city and I have to take players through lots of different areas; that city becomes the one I live in. My map has what is in (or what type of building) any given area and I list what special things I feel should be in certain areas. Special things are items like power guns, armor, computer systems, and robots. A place like the food store becomes the local one that I visit every week. Hardware stores, drugstores, clothing stores administration centers, etc. all become places that I have been in before and what the players hear are my memories of these areas and my throwing in things that are both useful to the player and

useful to the monsters that I have placed there. I make it a habit never to improvise on the placement of my mutants and alliance groups, feeling that that would be cheating since life in my world is hard enough. The only leeway that I use is that of the wandering creature that comes often to those that argue or cause a great deal of disturbance in any given area.

There seems to be a growing fear and/or worry that players will gain too big of an advantage from knowing the rules and thus knowing how to use the items of any given *Gamma World*. This kind of thinking is ridiculous. I once read somewhere about the referee that hated his gamers to be able to look up the strengths and weaknesses of any given monster in *D&D* and decide what to use against them and that struck me as very funny. First of all, I don't care how much you know about a thing in *Dungeons and Dragons* or any other role playing game; if that giant or vampire is out to get you all the garlic buds, crosses, silver, or clerics aren't going to do you much good without that bit of luck every player must have. Second, there isn't a monster on any list in any role playing game that I have ever judged that I haven't felt it my duty to change (just a little bit), so that problem doesn't exist. There is also the thought that with all those energy weapons, robots, and mutants running around, a player needs a little edge in order to survive from day to day. Finally, there is the gripe that players have it too easy when it comes to trying to use technology because of that fact that they go out of their role and use their "real" knowledge.

Take the ever popular statement that "If I have seen this gun fired I should be able to tell which way to point it and how to use it" type of thing. First of all, I think that it is necessary to reduce things down to their simplest terms. All guns, pistols, rifles, and the like become strange "crossbow devices" and everyone of them has many buttons, levers, and gauges that must be adjusted everytime the thing is used. (Yes, I know, it's a wonder that it gets a shot off every 10 melee turns let alone every single melee turn.) Along the same lines are the marvelous artifact operation charts that are vital to any operation of any device. I have naturally enlarged these things and combined them into one big chart that not only lists the successful operation of any device, it lists a possible breaking of that same device or the possible harm caused to the being fooling around with such a device. One time I was forced to give a party a bunch of powered suits of armor and they all tried to work them with great results, as far as I was concerned. When the first skull crossbones came up I had the armor break the arms of the being using the unit. When it came to the breakage of a unit I had the laser finger of the unit that was being fooled with melt parts of another unit. When players persisted and received another skull I had the unit break both the legs of the trying mutant. Of the entire group, it turned out that only one mutant could figure out the operation of the suits of armor and when she put a suit on and tried to pick up her two wounded friends her thousand fold increased strength squeezed to mush the waists of both her friends.

It is sometimes necessary to describe items in such a way as to make the players wonder what they are looking at. A bathroom sink becomes a white stone bowl; a metal highway becomes a god road that is unlucky to cross; and a sword becomes a huge carving knife of great weight.

As a final note, there are those that are said to be too sadistic in their love of killing player characters. This love takes the form of initially telling the players that they are going to die at his or her hands or breeding masses of monsters to wander about, or creating areas that even the most highly sophisticated being of the times before the destruction could not have figured out. There is nothing wrong with these areas if the players are reasonably cautious. To go a step further, there is nothing wrong with deliberately creating sections, groups of muties, buildings, what-have-you that are as deadly as the referee can think of, for several reasons. First, it is a mark of the good player that they survive and figure out these types of areas. Second, when a referee creates such a place, he creates items that can eventually be used by those that conquer. Lastly, what right do the primitive creatures that try for these great objects of technology have in not expecting to get maximum energy force directed back at them? At several tourneys I have killed off whole bunches of players merely because they failed to be cautious and that is exactly what my best group uses in every case. They are very powerful but even if they face things they have dealt with before, they cover every angle they can think of and then go ahead.

THE TUG OF THE MACHINE

by Allen Evans

Had they not been running so fast, at least one of them would not have died so soon. As it was, the length of the hall took them by surprise as they rounded the corner and they stopped short — seized by indecision.

The first one died then, the quarrel catching him high in the neck and sending him down before he had drawn two rasping breaths. The death rattle of their comrade seemed to serve as a catalyst for the others. They spotted him some thirty yards down the hall, winding his crossbow furiously in order to make a second shot. With a rushing of feet through dank air the two survivors charged, drawn weapons displaying shivers of light as the guttering torches on the walls were reflected from the blades.

In futility he tossed aside his useless bow and drew his weapon to meet their rush.

At the last second two quick steps moved him to one side and forward, allowing him to engage the leader, who was preceding his stocky partner. The air hissed as steel met steel and then reverberated with a scream as steel met man and the second of the trio joined his companion on the floor. The upward slicing stroke which had ended his first attacker's life now went to work on his second, bending over to come to a full crashing stop against the other man's guard.

Almost a dance, the combat circled and spun, twisting this way and that as the men struck and parried and then counterstruck. Slashing, almost wild blows were aimed at his head, only to be deflected or ducked. The stocky man made a lunge he would have thought impossible, save for the fact that it was deflected just enough by his own blade to slice through the outer folds of his tunic rather than through the skin for which it had been intended. But the effort proved to be his foe's final one as his own circling blade swung down to almost decapitate him.

He stood for a few moments breathing deeply to catch his lost breath and to feel the throb of the last blow slowly die away. They had left the initial meeting point of the combat further up the corridor and with slow and not altogether steady footsteps, he went padding down the hall to retrieve his crossbow and quiver.

He had just put his hand around the stock of the bow when the room blinked out.

* * * * *

When he woke he was staring into the hulk of the Machine.

Very slowly, he sat up, and began removing the series of wires attached to his scalp. The breaking of contact between his scalp and the tiny brain-pads on the ends of the wires sent a pleasant pain coursing down his spine which he, in a way, enjoyed feeling. There was no one in the apartment to notice, but the occasional glance he favored at the Machine was filled with a mixture of pleasure and pride. It was the most expensive present he had ever allowed himself to buy, for him, or anyone else. *Nine thousand credits. For five years he had dreamed and scraped and sacrificed to get the money.*

"Time, please," he said, rising from the chair kneading his head with his fingers.

The wall responded almost immediately with: "Five o'clock and twenty-five seconds, sir."

Almost twenty minutes late for his meeting with Michelle! But he caught himself mid-thought and debated going at all. The meeting was almost certainly a facade for a surprise birthday party. If it was one thing he couldn't stand, it was parties. Michelle was always doing that kind of thing and forever irritating him. He struggled with the thought of plugging another scenario into the Machine and gaming for another half hour, but then rejected it: picturing Michelle's crushed expression on the phone was too much.

He quickly got dressed, turned off the Machine and lights and left, locking the door behind him.

And as he slowly walked down the hall, he could almost hear the Machine calling after him.

THE TUG OF THE MACHINE

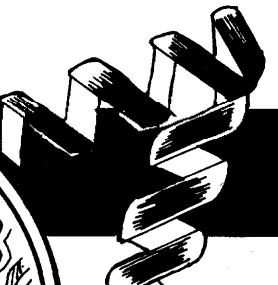

JANUARY
1987

THE ARMADA DISASTERS

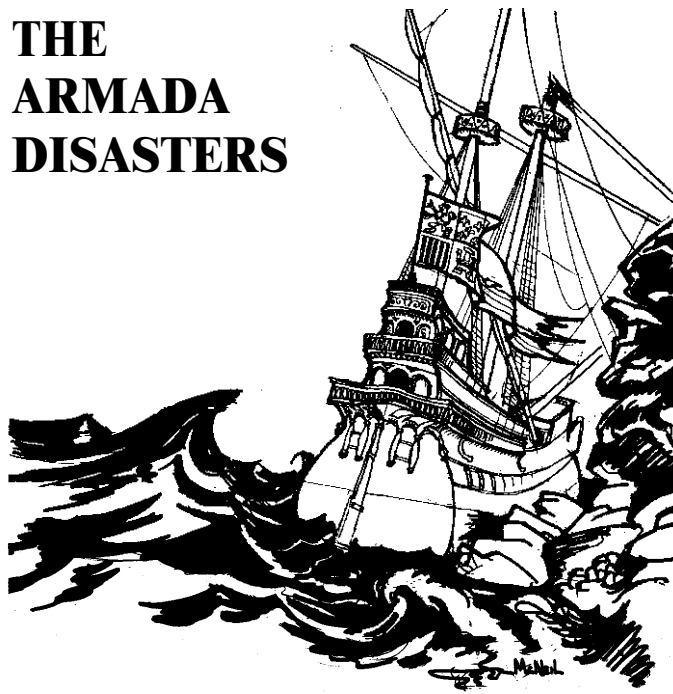

Tempestuous Europe — quarrelsome, divisive, seething. New alliances, old loyalties, quick hatreds, long-standing feuds. Enormous upheavals, centuries-old reactionary repressions. This was the muddled Continental picture as growing crises boiled over in the summer of 1588. At this time, King Phillip II of Spain sent his mighty fleet of warships to crush the increasing impudence of England's upstart Queen Elizabeth I and her motley sea dogs. At least, that was the expectation.

Sweeping alterations in thought and attitudes marked the final years of the Fifteenth Century which saw great seaward expansions with Columbus' Atlantic voyages and the circumnavigation of Africa to India. Shortly thereafter, Spanish adventurers Hernando Cortes and Francisco Pizarro conquered the American Indian empires of the Aztecs in Mexico and the Incas in South America, opening the Western Hemisphere to colonization and exploitation.

As wealth from the Americas began to fill the coffers of Spain and Portugal, Pope Alexander VI arbitrarily divided the world between these two Catholic powers, giving the West to Spain, with the exception of Brazil, which was later claimed by Portugal, and the Orient to Portugal, except the Phillipine Islands, which were to be Spanish.

And so treasure ships, heavily laden with the riches of the world, brought all manner of precious goods home to Spain and Portugal. Although the inpouring of wealth was staggering, far the largest portion of it was necessarily spent in maintaining the far-flung colonial empires.

In 1580, the King of Portugal died and King Phillip, a relative, was his natural heir. So Spain annexed Portugal with her vast holdings to her own empire. Phillip was then the most powerful ruler the world had ever known, with staggering responsibilities and weighty issues to decide.

Meanwhile, Europe was hopelessly split by the spread of Martin Luther's Protestant Reformation movement that threatened Catholic domination. German merchants of the formidable Hanseatic League controlled Baltic shipping, while the Netherlands, still not a national entity, was under tight Spanish control in the person of the Duke of Parma.

But upsurging England and France took exception to the Pope's partitioning of the world into two Catholic realms. Although the French lacked the resources to involve themselves directly in the New World conquests, they understandably wanted a share in the treasures. French privateers began to prey on the gold-carrying fleets in a satisfying combination of gaining riches as they fought to undermine Catholic persecution of French Protestants, or Huguenots.

England could not afford such cavalier action, as that country had

been allied with Spain for nearly eighty years. Her Catholic Queen Mary, daughter of Henry VIII, had married King Philip of Spain in 1554. But when Mary died without issue, her half-sister, Elizabeth, a Protestant, became Queen of England and established her own persuasion as the national religion.

England did not have the strength to oppose Spain openly, but after 1558, her power, particularly at sea, began to build. Elizabeth invested heavily in the voyages of her merchant fleet and thus added money to her treasury.

The English traders, including some of the queen's own ships, began to deal directly but "illegally" with West Africa, the West Indies, Russia, and even North America as they searched for a northwest passage to the Pacific. There were incidents and skirmishes as the Spanish moved to stop English depredations. Spain's monopolistic control of New World wealth and England's undercover determination to cut herself in for a share of the booty forced a showdown between the two countries.

Spain sought to place Elizabeth's Catholic cousin, Mary Queen of Scots, on the throne of England in complicated political machinations. A number of heavy-handed plots failed and Mary was to remain a virtual prisoner in England for eighteen years.

Elizabeth fought off all intrigues with diplomacy, lying, manipulations, wheedling, or brute force, as the occasion demanded. Her unpredictable strategies effectively cemented her own position, raised England's fortune and power, further confused the political situations of France and the Netherlands, and irritated and harassed Spain with constant sniping and dogging her flanks.

Elizabeth, conscious of Mary Queen of Scots' continual plotting against her, finally yielded to the advice of her counselors. Mary was beheaded on February 18, 1587, thus removing the stay of Philip to move against England. A month later, he ordered the Marquis de la Santa Cruz to activate his longstanding Enterprise, his master plan for the conquest of England by land and sea. England was aware of Spain's intentions and of the forthcoming full-scale war, and began to make plans of her own.

Backbone of Spanish sea might was the galleon, with two or three decks, usually three masted, and with heavy guns for armament. Wooden "castles" fore and aft were actually floating forts that afforded sniper strongholds for close fighting. Spanish admirals preferred short range bombardment with their large bore cannons, and then moving in for grappling, boarding, and hand-to-hand combat.

Galleys, small and light with iron beaks at their prows, were used successfully by the Spanish in Mediterranean warfare, using ramming as their offensive technique. Lightly armed and rowed by banks of slaves or prisoners, galleys were ill-equipped to withstand the savage onslaughts of the open ocean.

Therefore, a new class of ship combining the best features of galleons and galleys and called the galleass, was being developed. The galleass was midway between the two other vessels in size and was also made of wood, used both oars and sails, and was heavily armed.

The English, used to the treachery of the North Atlantic, concentrated their efforts on highly maneuverable sailing ships. Under the leadership of John Hawkins, the navy was ridding itself of decrepit tonnage and corrupt officials while designing more effective men-o-war and improving the lot of seamen.

English dreadnaughts were stripped of their topheavy castles and new ships were more streamlined. They could carry more sail and turn into the wind with greater speed. Heavily armed greatships were also a mainstay of the English fleet.

But the most effective idea, brainchild of Hawkins and his mentor, Sir William Wynter, Master of Naval Ordinance, was their reliance on lighter demicannon which fired a thirty-pound ball (as opposed to the fifty pounders hurled for shorter distances by the guns of Spain) and on culverins and demiculverins. This permitted long range salvos that could inflict great damage on enemy ships without closing.

With her fleet ready, Elizabeth still procrastinated. In April, 1587, she finally permitted the swashbuckling Sir Francis Drake to put to sea with a complement of twenty-three vessels in a private venture of spying, raiding, and blockading.

Upon reaching Portuguese waters, Drake boldly began a frontal attack on the massed vessels in the harbor of Cadiz. There, some sixty ships, in varying stages of repair, were being readied to join the Enter-

prise, the Armada, and were hopelessly crowded together. In the ensuing battle in which the Spanish were sitting ducks, between twenty-four and thirty-seven of their ships were sunk and Drake reprovisioned his own fleet at the enemy's expense. He also learned that the main Spanish fleet was rendezvousing in Lisbon, and that Commander Don Juan Martinez de Recalde, with half a dozen ships, was waiting at sea to escort the treasure ships that were returning from the West Indies.

Drake decided to sail to Cape St. Vincent, a strategic point, to intercept Recalde. Not finding him there, Drake nevertheless went on to capture the stronghold, destroying the castle, the monastery and its fort. He then ran amuck, sinking fifty tuna fishing boats and fifty barrel-carrying cargo ships, both groups vital in supplying the Armada. Unable to attack Lisbon directly, he returned to Cape St. Vincent to rest his crews and clean his ships.

Heaping insult upon vast damages, Drake then captured the car-rack, the *SAN FELIPE*, a personal ship of King Philip, a loaded treasure ship of jewels and gold, velvets and silks, china, porcelain, and spices. Taking his prize to England, Drake was championed for seriously crippling the Spanish war effort and for delaying the sailing of the Armada. Elizabeth claimed her share of the loot while publicly disclaiming responsibility for Drake's deplorable actions.

King Philip was understandably enraged. The next spring, with his commander, the Marquis of Santa Cruz dead from overwork and exhaustion, he appointed a successor, Don Alonso Perez de Guzman el Bueno, Duke of Medina Sidonia. This exalted commander felt he was unqualified to lead so vast an undertaking as the Armada, but Philip waved aside his protests and bade him set out with the flotilla post haste.

Medina Sidonia, with his council of advisors, worked feverishly to modernize the moldering collection of outmoded vessels languishing in the harbors, but few improvements were possible in so short a time. Finally, all feasible preparations were completed and the Enterprise, the Armada was ready to get underway.

Misfortune dogged the expedition from the start. They were unable to sail in the middle of May because unfavorable weather persisted for three weeks. Another similar period of time was then consumed while the fleet crept only as far up the coast as La Coruna, Spain because they were slowed by the crawling pace of the storeships.

At La Coruna, the entire fleet put in for fresh water and vital supplies, but only half were able to anchor in the harbor. A terrible storm in the night blew some seventy ships out to sea and it was many days before they could reorganize and set forth again.

Under the command of Medina Sidonia, in the first line of battle, were ten galleons from the Indian Guard, nine galleons of the Portuguese Navy; the Italian warship, *SAN FRANCISCO*; four galleasses; and four greatships.

The second line of battle consisted of forty armed merchantmen, ranked into four squadrons; twenty-three storeships; thirty-four pin-naces; and five other small vessels.

King Philip's grand plan for the conquest of Britain was for the Armada to proceed to the English Channel and there rendezvous with the Dutch battalions of the Duke of Parma. After escorting these troops in their barges across the channel for the invasion of England, the Armada was to destroy any opposing ships at sea or in the harbors. Spain supposed the English fleet to be inconsequential.

Meanwhile, Sir Francis Drake had been impatient for action for many months. He had badgered Queen Elizabeth to let him sail for Spain to take offensive action, but she hesitated. Finally, in May, all available ships were provisioned and ready for duty. Lord Howard was in command, with Drake as his first officer.

On Friday, July 29th, 1588, the Spanish Armada was sighted off the Lizard, the tip of the Cornish coast, and on their way to Plymouth. By evening, Lord Howard was able to put to sea with fifty-four ships while others were still loading. These ships slipped around the Armada to the south, there to wait for daylight.

The Armada had remained intact on the difficult voyage from Spain except for the four galleys which were unable to weather vicious Atlantic gales and had to seek French ports, and one merchant ship that had disappeared. Medina Sidonia, in that night of waiting near the Lizard, believed Drake's ship to be in Plymouth harbor while Lord Howard's forces were still patrolling the Dutch coast. He moved his fleet closer to Plymouth the next day.

Sunday morning, July 31, 1588, saw the first meeting of the English and the Spanish, who wheeled in unison in a magnificent display of seamanship and discipline, to meet the south-lying enemy, The armada, in crescent formation with Medina Sidonia's flagship, the *SAN MARTIN*, in the lead, faced nearly two hundred ships of superior fire power, including the huge *TRIUMPH*, the 1,100-ton warship commanded by Martin Frobisher. Additionally, the English ships, though many were smaller, had the advantage in maneuverability.

The battle was joined. The English challenged the crescent's right wing with Lord Admiral Howard in the *ARK ROYAL*, while Drake's *REVENGE*, Frobisher's *TRIUMPH*, and John Hawkins' *VICTORY* sailed against the Spanish forces to the left. English long range culverins opened fire, and when the Spanish came out to meet them, the nimble attackers fled. The English also had the wind advantage, a major factor.

That afternoon, the powder magazine of the Spanish greatship, *SAN SALVADOR*, exploded. In the confusion that followed, the English attacked again and two Spanish ships collided. The sea roughened as the wind increased and fighting broke off, leaving the still-virtually-intact Armada to move on eastward up the channel.

The English pursued, not wanting the Spanish to rest or refit. They captured the *ROSARIO* and the *SAN SALVADOR*, two rich prizes. Monday and Tuesday saw continuous skirmishing and heavy firing, and by Wednesday, both fleets were growing short of ammunition. Thursday, all vessels were becalmed, but as the wind freshened, the Spanish took quite a pounding from English squadrons.

The Armada, low on supplies, kept moving through Friday and most of Saturday, and then dropped anchor that night in Calais, France, to await word from the Duke of Parma in Holland. The English, at rest less than two miles away, received reinforcements of ships and ammunition, raising their strength to 140 vessels.

Medina Sidonia learned, to his chagrin, that the Duke of Parma was far inland with his men and would not be ready to move for at least two weeks. In addition, no food or supplies would be forthcoming from that quarter. Then the English sent eight fireships drifting toward the massed Armada, and the Spanish scattered hopelessly in panic.

Monday, August 8th, saw some of the bitterest fighting to date, with the English pounding at the disorganized, retreating Armada. Eventually, both sides were out of ammunition and the scene faded in the confusion of yet another storm.

So far, in nine days of sea battles, the Armada, which had originally numbered 130 ships, had lost nearly half its strength and over 600 men killed with another 800 wounded. They were in total rout with the English fleet, still at full strength, dogging them unmercifully. The Spanish were completely demoralized and they prayed for deliverance.

Then that night, the capricious winds shifted again and blew the Armada northeast far out into the North Sea. The helpless English, could only follow and watch. The Spanish were grateful for this turn of events and gave thanks for their miraculous escape.

But tribulations were only beginning. Winds continued from the same quarter so the Spanish had no recourse but to go on northward past Scotland. The English finally turned homeward.

Armada survivors rode the storm-riven seas, cold and hungry, in holed, demasted hulks barely able to keep afloat. Many of these ghastly wrecks were without anchor or rudder, and after rounding northern Scotland between the Orkneys and the Shetland Islands, gutted themselves on the rocky fangs of Northern Ireland's hostile shores. At least seventeen ships went down in these wild seas, with a loss of more than a thousand men. Most survivors were duly murdered on shore and stripped of all possessions. Only a few of these unfortunates made their way back to Spain.

First Spanish ships of the ill-fated Armada, still lead by the *SAN MARTIN*, limped into the harbor of Sanlader, Spain, on September 23, 1588. Considerably less than half of the total returned, and most of the great commanders were dead or dying along with many of the crews. Medina Sidonia blamed himself for all the misfortunes of the Enterprise, but King Philip would hear none of this and kept him on in his service.

But all was not peace and thankfulness in England. Faced with bankruptcy, the Crown could ill afford to pay off her victorious sailors and send them home, so many were dying of disease and malnutrition aboard their ships. Frobisher and Drake were accusing each other of

blundering and cowardice, John Hawkins and Lord Howard were vastly dissatisfied.

Impetuous Sir Francis Drake was now planning his own Armada as a private venture, and he assembled sixty English merchantmen, sixty assorted Dutch ships, and six royal navy greatships. His idea was to destroy as many Spanish Armada ships as he could find in port, and to take with him one Don Antonio de Crato and establish him on the throne of Portugal, thereby wresting control of that country from King Philip.

This ill-conceived expedition was foredoomed to failure. When finally launched in June, 1589, Drake's ships sailed southward to La Coruna, where Commander Bertendona scuttled his ship, the *SAN JUAN*, to keep her from falling into enemy hands. Drake's men captured the city, but little booty was to be had.

Later, they sailed on to Lisbon where they found the Portuguese unwilling to accept Don Antonio as their king. They subsequently set out for the Azores, but the stormy Atlantic willed that they should never reach those islands. The English Armada was forced to return to England with 8,000 of Drake's men dead and a number of his ships lost, and he was in total disgrace with his queen.

Out of the lengthy war with its terrible price in men and ships, Spain lost her dominion over France and the Netherlands. England kept her eyes on the sea and eventually secured huge tracts of the New World as well as the Orient and Africa for her own empire.

In recent years, divers have found the wreckage of some of the Spanish ships lying at the bottom of the cold, turbulent North Atlantic off the fierce coast of Northern Ireland. Among the relics recovered from the remains of a ship identified as the Napalese galleass *GIRONA*, are gold and brass ornaments, jewelry, cannon, lead ingots, and cannonballs. There are also gold and silver coins, pottery, chains, buckles, and cutlery, in a remarkable collection of momentoes forged in persistent salvage operations.

It may be anticipated that in the future the sea will grudgingly surrender more of her ill-won souvenirs of the Armada, and that we will gain more precise knowledge of the fate of other Spanish ships.

STARSHIPS



*Quality lead miniatures
for deep-space adventures!*

Our Starfleet Scale™ ships will enhance any space war game . . . and now, by arrangement with Gamescience, we have miniatures of the famous Alien Space™ ships!

And coming soon from Eisenwerk: Alien Space™ rule supplements . . .

Eisenwerk makes over 40 different starship miniatures — as well as 1/2400 ships, 1/288 tanks, and much more.

For complete information, write:



precision design & casting

**1207 Marleen
Houston, TX 77034
(713) 941-8508**

Wargamer/Artist Wanted

TSR Hobbies is looking for an artist. College training or experience and being a War Gamer are necessary qualifications for this position. Knowledge of human/animal anatomy and a skill with pen and ink are most important. Send a resume and, if you wish, a few black and white 8½ x 11 samples. All illustrations will be handled with care and returned to the owner. Sent to TSR Hobbies, Inc. Art Dept. P.O. Box 756, Lake Geneva, WI 53147.

Convention Schedule 1979

MichiCon VIII (June 1-3) sponsored by the Metro Detroit Gamers at Oakland University, Rochester, MI (Just North of Detroit). Over 25 board game tournaments, 10 role-playing game tournaments, over 60 miniatures tournaments and demonstrations, seminars/panels/workshops, auctions, flea markets and over 50 exhibit booths. For more information and pre-registration flier send a SASE to Metro Detroit Gamers, MichiCon VIII, P.O.B. 787, Troy, MI 48099. Pre-registration deadline is May 10, 1979.

XON-CON (June 2,3) at Knights of Columbus Hall, Dixon IL Role-Playing, Boardgames. For more information call: 815-284-3254.

Wargames West '79 (June 8-9) at the Fresno Convention Center, 700 M. Street, Fresno CA. Contact: Elliott Dermon P.O. Box 261, Kingsburg, CA 93631.

GLASCON IV (June 15-17) sponsored by CSUN Simulation Gamers' Association. \$3.00 Pre-registration Fee. \$5.00 at the door. For more information write CSUN-SA, 7133 Reseda Blvd., Reseda, CA 91335.

Origins '79 (June 22-24) at Widener College, Chester, PA. For more information write: Origins '79, P.O.B. 282, Radnor, PA 19087.

NANCON II (June 30-July 1), at the luxurious Houston Marriott. Largest Dungeons Tournament in the Southwest. Two Day Admission: \$5.00 until June 1 (\$6.00 after June 1). Dealers Room. Seminars on Sunday. For information or early registration contact: Nan's Toys and Games - 1385 Galleria Mall - 5015 Westheimer - Houston, Texas 77056 (713-622-0760 after 5:00 PM CST) Room Reservations through Houston Marriott - 2100 S. Braeswood - Houston TX 77025 (mention NANCON for room in gaming area).

The Great Canadian Games Adventure

May 18-21, 1979

(Queen Victoria's Birthday)

Ottawa University

Ottawa Ontario CANADA

Tournaments in EVERY aspect of gaming

Talks and Seminars by guests, game designers

Games from Europe, England and Canada (American Favorites too!)

Lots of Dealers, Open Gaming, Films and Auctions

No Game Registration Fees!

Good Dorm Accommodations and 24 hour restaurants

Guest of Honor: Gary Gygax

For More Information: Phone 613-745-2073 or Write CANGAMES 79, 201-360 Dundas St. Vanier Ontario CANADA K1L 7W7

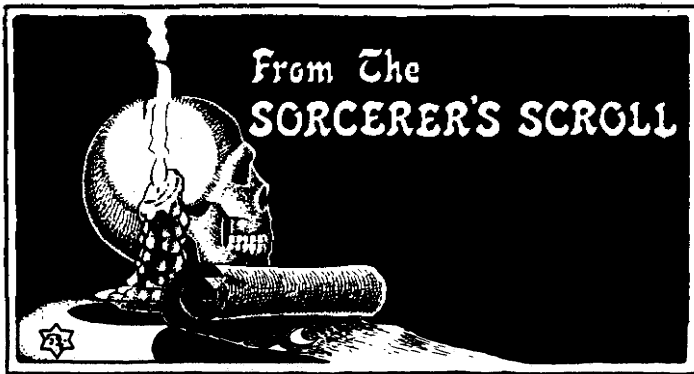

THE PROPER PLACE OF CHARACTER SOCIAL CLASS IN D&D®

©Gary Gygax

Insertion of randomly determined social class is sometimes touted as an improvement or valuable addition to the existing game system. This sort of assertion seems valid on the face of it, for doesn't the game benefit from assigning social classes to player characters? Isn't a new dimension added when the rank of characters is known and considered? Before answering those questions, consider from whence the idea of social classes came. Professor M.A.R. Barker suggested social classes in his instruction manual for his monumental game, *EMPIRE OF THE PETAL THRONE*. The *EN GARDE* game by Game Designers Workshop contained a lengthy treatment of social class and birth tables. Those who saw these works and decided to insert them into *D&D* failed to recognize one important singularity common to each of the aforementioned games which is not possessed by *DUNGEONS & DRAGONS*®/*ADVANCED DUNGEONS & DRAGON*®. Both the world of Tekumel and that of the Three Musketeers *etal* have a complex and detailed social system already devised for them — one from the creativity of Professor Barker, the other drawn from the history and legends of the period of Cardinal Richelieu, the early Seventeenth Century. *D&D* has no such cultural and social background.

Because *D&D* does not have a predetermined culture and social structure, it is totally foolish to plug in a system which assigns a class rating to characters, unless the social class determination is very basic and non-specific such as:

- 01-75 character is of common background
- 76-95 character is of aristocratic background
- 96-00 character is of upper class background

Note that this sort of determination is not particularly useful, but it does not preordain a social order, either. Use of a more specific method causes the Dungeon Master to automatically accept a social order he or she may well have no desire to include in the campaign, for lack of knowledge or personal preference or any other reason. All of the social distinction tables assume nobility or offices or professions which are not universal to all cultures. Use of such tables means that the DM has accepted the premise that his or her campaign, in fact, has such classes of nobles, professions, or offices.

D&D is a fantastic medieval game system. This does not mean that it is medieval in the European sense, although a campaign milieu based loosely upon mythical feudal Europe is not precluded. However, it could as well be set in the Near or Far East, in a mythical place, in a mythos with an ancient-medieval atmosphere (such as Robert E. Howard's "Hyborean Age"), or just about any other desired milieu. The important factor is medieval technology, not necessarily feudalism with primogeniture, entail, and a Salic Law.

So-called birth tables are likewise of highly questionable value to DMs. These tables dictate to the Dungeon Master the rank of a male player character's birth, i.e. first, second, third, etc. Again, the information is useful only when a culture which is basically feudal European (with primogeniture, entail, and Salic Laws regarding inheritance and titles) is considered. What if some other system is desired by the DM?

Out the window with the birth tables, of course. Furthermore, even if a basically feudal society is presupposed in the campaign, what use are birth tables which indicate that a player character is a first-born son of a ruling monarch or major noble? How can one conceive of such a personage going out adventuring at the risk of life and limb?! Has the individual abdicated his inheritance? Does he have amnesia? Where are his guards and retainers? Does his sire know what he is doing and where? And all of this when a compatible social order is considered. Now envision use of such systems in a milieu which is neither feudal nor male-oriented — a hierarchy based on matriarchal principles, for example. Inclusion of such tables simply is unthinkable. For these very reasons, *D&D* does not contain any systems of social classification, for the DM must first decide upon the culture and society of the campaign before any valid system can be designed, and there are far too many variables, so the task is strictly that of the DM. Any detailed system will impose its own order upon the campaign, as well as possibly forcing the DM to accept certain premises regarding player characters which do not fit into the schema of the milieu.

For the sake of discussion, a number of government forms are given below. Several of these names were coined on the spot in order to describe types of governments which would be applicable in a *D&D* campaign milieu. The list is by no means exhaustive, and DMs should feel right in devising any sort of government which is reasonable within the parameters they have set for their particular "worlds". Government forms are:

- ANARCHY — No formal government and no social classes
- ARISTOCRACY — Government by a privileged class, this class so vested with power to rule being determined by virtually any circumstances of social or economic relevance
- AUTOCRACY — Government which rests in self-derived, absolute power (an emperor or dictator is typically an autocrat, but the variations are many)
- BUREAUCRACY — Government by department, rule being through the heads and chief administrators of the various departments of the system
- CONFEDERACY — A league of possibly diverse governmental and social entities designed to promote the common weal of each
- DEMOCRACY — Government by the people, i.e. the established body of citizens, whether direct or through elected representatives
- FEODALITY — Feudal government where each authority derives authority and power from the one above and pledges fealty in like manner
- GERIATOCRACY — Government by the very old
- GYNARCHY — Government by females only
- HIERARCHY — Typically religious government with a structure somewhat similar to a feodality
- MACOCRACY — Government by professional magic-users
- MATRIARCHY — Government by the eldest females of whatever social units exist
- MILITOCRACY — Government by military leaders and the armed forces in general
- MONARCHY — Government by a single sovereign, usually hereditary, whether absolute in power or limited (such as the English monarchs were by the Magna Carta)
- OLIGARCHY — Government by a few, usually absolute, rulers who are co-equal
- PEDOCRACY — Government by the learned and savants
- PLUTOCRACY — Government by the wealthy
- REPUBLIC — A government of representatives of an established electorate
- THEOCRACY — God-rule, or rule by a god's direct representative

Let us assume a campaign in which the DM desires to develop play around two diverse portions of the campaign area, in this instance a portion of a continental land mass. The western nation is an oligarchy, while the east is fragmented into numbers of small feudal states which the oligarchy keeps in constant turmoil and warfare through clever machination. If player characters begin in an eastern land — more likely a place for adventuring — the social order will tend to be feudal or

semi-feudal. Let us further assume they start out in a small province of a small kingdom ruled by an absolute monarch. Near equals to the king are the peers of the realm — dukes, princes, the greatest churchmen, marquises, counts (or earls), great churchmen, viscounts, barons, and lesser great churchmen. Considered separately are knights, for those given this status by the king are peers, those with lesser knighthoods still ranking amongst the nobility. Of course, nobles are not necessarily knighted; and knighthood, unlike titles of nobility, can not be inherited.

Below the nobility and knights is a broader class of society, the gentry. Gentlemen, or the gentle born, are from families with land holdings or great wealth from mercantile activity and the like. The great offices of the kingdom — chancellor, marshal, constable, etc. — are drawn from the nobles; but the lesser office holders — bailiffs, magistrates, justices, etc. — will be drawn from the gentry. Outstanding members of the class will be knighted. Exceptional knights will be elevated to the peerage. Civic leaders are typically of this class.

Next after the gentry are the freemen and artisans. This class is comprised of small landowners, tradesmen, and skilled craftsmen. This class furnishes candidates for very minor offices of the government and will be active in the affairs of small community government, usually serving under the leadership of a gentleman. Rarely will members of this class be knighted.

Below the freemen and artisans come the laborers. These are free folk, but they have neither land nor skills. They are tenant farmers, workers, and peddlers. These folk come under all of the upper classes, and they can aspire to become freemen, although there is little likelihood of this move occurring, as money or opportunity is scarce.

The lowest class is far and away the largest. It is made up of servants, bondsmen, and serfs. Servants and bondsmen can eventually move into the laborer class; serfs can have no such hope, as they are confined by law to work the land for their liege lord, be it nobleman, churchman, gentleman, or even freeman.

Player characters beginning in this social order will be of noble origin only if the DM desires to include this as a factor. Frankly, only the younger sons of any noble family would have any reason to become adventurers in most cases, for the first born will inherit the title and lands, and the second and third sons will certainly be provided for by means of clerical offices and government positions. Royal sons are always given titles and lands regardless. If first-born sons or royal family members become involved in a campaign as player characters, there must be a reason for this! Where will adventurers come from then? Not from the peasants, for they are probably absolutely forbidden to possess and bear arms, except when impressed into levied bands by their liege lords. Most adventurers will come from the laboring, freeman/artisan, or gentle class. The percentage of adventurers from each class is entirely dependent upon campaign circumstances such as the largest urban area nearby, local and regional government, economic factors, etc. Let us suppose, for the sake of the example, that there is a 5% chance that a character will be from the lowest class, 10% chance of being from the laboring class, 30% from the class of freemen and artisans, and 50% from the gentle class. (More weight is given to the more privileged classes as they are more likely to be able to afford or otherwise have the means to have their sons — or daughters — given the background necessary to become an adventurer.) A 5% chance is also given for a lesser noble class background, for anything greater in percentage or higher in class would cause severe campaign anomalies. What does this all mean?

Well, starting funds and equipment must be adjusted to suit social class, although some weight can be given to the possibility of previous gains and losses to balance things out a bit. The major effect such social level determination would have is in the area of profession. All thieves and assassins could come only from the two lowest social classes. Clerics could come only from the levels above the two lowest. Magic-users could come only from the three highest levels. Paladins could come only from the highest class. In general, skills learned before becoming an adventurer are non-existent outside those peculiar to the profession of the character. For example, the son of a cheese maker will be sent away at a young age to receive a clerical education, or serve as an apprentice magic-user, without benefit of training in his father's business. Each adventurer will have basic skills and knowledge to his or her profession and little else. Fighters are the sole possible exception, for

their apprenticeship would typically come later and consist of service with a levied or militia force, then as a mercenary or recruited man-at-arms, and only thereafter as a 1st level (veteran) fighter. Therefore, consideration to the possibility of the character possessing one or more skills in addition to fighting ability is not unreasonable. These skills would be commensurate with social class and background based upon the milieu.

D&D was purposely sketchy and vague regarding government and social systems, for not only would any attempt at detailing such information be of considerable length, but it would also take away the prerogatives of the DM. The governments and social systems of a campaign should be devised and developed directly by each individual DM with an overview of his or her entire campaign, both the introductory milieu, and the eventual scope of the "world" and the universe (or "multiverse") in which it is set. To force any order upon the DM is to curtail the scope he or she has in devising such settings. This is not to say that it is wrong to have package offerings such as the Judges Guild *CITY-STATE* or TSR's *WORLD OF GREYHAWK*. In such as these, there can be no question in the purchaser's mind as to what is offered, a milieu which is already developed. The *D&D* rules are distinct, however, in that they instruct the DM as to how the game is played and mention only in passing that an entire "world" must be developed to house the campaign. The design of that world was left as the purview of each individual DM. The explosion of *D&D*'s popularity, and human nature too, has tended to promote an increasing acceptance of social class distinctions and tables without due consideration for long term campaign effects. At the very least this has resulted in some very odd settings, and at worst it has promoted the early demise of campaigns — typically with attendant reorganization and restarting with revised ideas and rules. In order to save DMs from this difficulty, a thorough treatment of society and government forms is needed. Space and time disallow any indepth treatment, even assuming a qualified authority could be found to do a thesis on the topic for us. DMs must be prepared to research the topic for themselves and develop systems which suit their needs.

D&D is principally medieval in respect to the technology of its arms, armor, and military arts. Even assuming the DM wishes to adhere to a medieval milieu, many sorts of historic government forms and social orders are available—the English monarchy, the Swiss confederation, the Holy Roman electorate, the Byzantine Empire, various Arab states, or even the horse nomads of Central Asia can be used as models, and that is but a sampling. Consider some of these other possible forms which may or may not draw upon historical bases. Then create the societies you desire.

It is obvious then, that only the individual Dungeon Master is capable of properly establishing the social order of his or her individual campaign. Active inclusion of this consideration will necessarily place some further restrictions on player character choices as to profession, but this is not necessarily a drawback; and it might well be desirable in certain cases, as it will tend to encourage more fighters and reward them with bonuses in the area of knowledge and skills not possessed by other classes of adventurers. Inclusion of an overall social structure and classes is, of course, a necessity in any large campaign. This is not merely an embellishment; it is an integral part of the development of the milieu. Furthermore, inclusion of important personages from higher levels of society will tend to add greatly to the campaign in various ways, whether from taking service with a noble to rescuing a prince or princess, such interaction adds to the scope and meaning of the campaign.

What is also obvious is that social class is certainly not something to be added lightly, a factor to be sprinkled whimsically into the campaign or tossed into the whole by random chance. A well run and meaningful campaign will have an equally well devised social system and class determination according to forethought precepts. I suppose it is best summed up by the old adage, 'class will tell' . . .

DMG Finished

As of this writing the manuscript for *DUNGEON MASTERS GUIDE* has at long last been completed, save for a few pages of probable rewrites and transitional material which editing will uncover. This has been a long and lousy struggle for me, as there have been so many other things to do, and great numbers of interruptions in the work flow. It is fun to be

Continued on page 33

Out on a Limb

A review of the film, "The Lord of the Rings," in the form of an open letter to Saul Zaentz and Ralph Bakshi.

Dear Saul and Ralph,

Your film was a rip off! Yes, rip off! I know that the expression has moral connotations, and that you haven't done anything wrong *legally*; but I happen to believe that moral obligations often make demands that go beyond the demands of law. So stay with me for a few paragraphs, and I'll explain why your film is immoral.

Let me start by saying that I'm not an outraged purist. I've read the Trilogy about six times, but I went into the theater with no expectation whatsoever of seeing a movie that was "just like the book." Film and print are two different mediums of communication. There is no way for a film to capture everything that can be put into a book, and a film can express things that no writer could hope to accomplish.

So I'm writing right now, not as a Tolkien fan, but as a movie fan (I love movies and attend the cinema about thirty times a year). As a movie-goer, there were three things I expected from you: good animation, a captivating and logical story, and clear guidance into the alien mythos of Middle Earth. You only gave me one and a half out of three.

My wife watched this movie with me. She never reads fantasy or plays fantasy games. When we walked out of the theater, I knew what she was going to say before she said it: "Wasn't the animation good?" Superb. Congratulations guys, I loved it too.

"I think I understood the part about Frodo and Sam . . ." The story was clear concerning these two. She did get confused about Gollum, though. She had so much to learn about between the appearance of Gollum in the introduction, and his reappearance late in the movie, that she forgot who he was.

" . . . but frankly, I didn't understand what happened to the rest of the characters in the second half of the movie. I couldn't see how it related." And that's because you blew the second half of the movie. You used a lousy, mistake riddled, confusing script, that only a Tolkien fan could understand.

Why didn't Frodo's sword glow in the battle with the orcs? Bilbo said it would. Who was this Strider guy? Why did he have two names? Why was his sword broken? Couldn't he afford a new sword? Did he get a new sword later on, or did somebody fix it for him? What is the relationship between Rohan and Minas Tirith? Where did Gandalf get that army that he used to save the army of Rohan? Why were some of the orcs bigger than the others? What were they fighting each other about that one time with Pippin and Merry? What was the significance of Pippin and Merry running into that talking tree? They just seemed to somehow fade out of the story. Did Gandalf really succeed in driving the forces of evil from Middle Earth at the end of the movie? Then why was the ring important?

Of course I know the answers to all these questions: I'm a Tolkien fan. But my wife isn't, and she's confused. What made you think that you could drop names like Rohan and Arathorn as if you were making a passing reference to Jimmy Carter and America? The least you could have done would have been to have worked some sort of a map into the story. You could have had the characters read it while they were discussing their options. This would have at least given the uninitiated some chance of understanding what went on.

Ralph and Saul, you ripped us all off. Know why? Because you released a movie of such poor quality, knowing that it was poor quality, but knowing that you would make money off of it be-

cause of the popularity of the literary work it was based on.

Oh, I should say a word about the ending. It didn't. End, that is. You should have written "To be continued. . ." across the screen. Better yet, write it across the ads. "The Lord of the Rings:" That's the title of the whole trilogy, guys. You used it in your ads, but you forgot to tell us in advance that you weren't going to tell the whole story. Shabby.

You think I'm being too harsh? Let me ask you this. Would you even *seriously consider* releasing a film with this many flaws in it if it wasn't based on a famous piece of literature that would guarantee it a built in audience? Only if you were really stupid. But you're not stupid. You're just too cheap to do the job right. Or maybe you just don't care enough about your art to fight just a little bit harder with your backers for just a little bit more money so that you can get a decent script.

Twenty million americans have read that Trilogy. Many of them would go and see any movie based on it, even if they heard it panned in a review. They just couldn't resist. I think that you banked on that (excuse the pun) when you did this movie. And I say that's a rip off.

Up until this point in the letter, I have been speaking on behalf of those who have never read the Trilogy. Perhaps that's presumptuous of me, but I think I've been fair. Now I want to say a few words as a purist.

Fine animation. I understand that some of the scenes were done by filming live actors, and then drawing animation on over the film. I was so caught up in the visual treat of the movie, that there were times when I wasn't even noticing the changeover from pure animation to the redone scenes. Really well done.

The characters and the creatures were reasonably well represented. You couldn't please everyone, but you did a good job

overall. Personally, I thought your orcs were too much like your ring wraiths, but then you made up for that with your superb balrog.

Thank you for leaving out Tom Bombadil. It would have taken you at least twenty minutes to do justice to him, and you didn't have the time. So you left him out entirely rather than portray him inadequately. A wise choice.

Would that you had used the same wisdom in dealing with Treebeard. A pox upon you for what you have done to my beloved Ent. Oh, I know, you were going to reintroduce him in the sequel, when you would have the time to do justice to him. But you did such a poor job on the first film, that you may not be able to raise the money for a sequel.

Slow moving, slow thinking, purposeful Ents, interacting with tiny, flighty little hobbits. One of the most imaginative creative, appealing, and just plain old fun concepts I have ever read. The Ents alone make Tolkien's works a classic.

Do you know what you did with Treebeard? You used one of the most endearing literary concepts of all time as a gimmick. To the uninitiated, his scenes in the movie were no more meaningful than the various aliens in the bar scene in "Star Wars."

Assuming that you can raise the bucks for a sequel, I would like to make a few suggestions. Don't use superb literary concepts as tinsel. Don't use a script that only insiders can understand. Don't introduce people and places so casually.

And don't be Hollywood pimps, using a beloved literary work as a prostitute to make a cheap buck. Make it a film that will entertain without confusing. Or else do the world a favor, and don't make it at all.

Mark Cummings — NY

There's not a whole lot I can say about the foregoing. Had I written the review of LOTR, as I had

planned before I went to see it, it would scarcely have been any kinder. To the contrary, it would have been far more cutting and critical. I hope Messrs. Zaentz and Bakshi take heed. —ED.

Dear Editor:

I totally disagree with the author's comments concerning ALPHA OMEGA in the Sep. '78 ALPHA OMEGA review. The criticism that the author levels at the game borders on being totally absurd; a little logic and common sense reduces the author's complaints to nothingness.

The first complaints the author lodges against the game have to do with its components. Admittedly, its counters are not the best in the world; neither are they the worst, though. The different shapes of the counters make for an excellent variety; I would hardly define their "shape-coding by type" as "an idea that doesn't work out too well in play." The "black on purple" situation that the author spoke of, in which the ship types and names are printed in black ink in a violet background, is hardly the eyesore that the author makes it out to be;

when played in a well-lighted room, the names and types of the counters can be read with ease. As for the mapboard being two-dimensional, so what? The author openly admits that the only thing 3-D movement in ALPHA OMEGA would do is slow down the game; to add something to a game simply because all the other gamers have it (which is *not* the case here) is totally wrong. I totally disagree with the author's complaints about the time scale of the game, with each turn being equal to six seconds of time; the time span would be quite realistic when you take into consideration the possibility that ultra-sophisticated (by our standards) computers would be handling such things as tracking, weaponry firing, and the like. As for the author calling it a "naval game set on a starfield map," the author could use that phrase to describe several space wargames, ranging from GALAXY of old to IMPERIUM.

To condemn the game for having its forces modeled after the Navy is ridiculous. Equally ridiculous is the author's assertion that the game is "pure Buck Rogers." ALPHA OMEGA is as advanced a space wargame as you can come

across; to compare it to a Buck Rogers game would be like comparing a sparkling diamond to a lump of coal.

The author's next criticisms of ALPHA OMEGA stem from the author's beliefs that ALPHA OMEGA lacks "realism." In case the author has forgotten, the author is not talking about *fact*, the author is talking about *fiction*, *science fiction*, remember? The game isn't supposed to be real to start with, so why complain that it isn't? The complaints that the author lodges against such names as the "Argonne Accumulator" and the "Dacer Shield" are unrealistic; if I were responsible for creating something, I'd want it named after me, so why shouldn't the people of the future do likewise? As for the complaints about the use of such names as "Balushi" and "Akroid," so what? Let the game designers have a little fun, the world *won't* come to an end, you know. When the author complains that the weapons used in the game strike their targets instantaneously, the author does not take into consideration that the weapons could just seem to arrive at their targets instantaneously, as is the case when a light is

turned on in a darkened room. The unrealistic energy expenditures that the reviewer talks about again shows the reviewer's forgetfulness that the author is dealing with science fiction. You are *not* dealing with energy as you understand it, whoever wrote the review, you are dealing with a new form of power. It makes as much sense to judge the crystal power via contemporary energy standards as it does to judge the taste of an apple by biting into an orange.

Fortunately, the author does not give the game a 100% bad appraisal, although a 99.999...% appraisal would be more accurate. The author says that the simultaneous movement that the combat that the game uses is good; the author also praises the game's movement pads and combat resolution via computer matrixes, as well as the game's having a CRT that has different tables to be rolled on depending upon the number of energy factors that strike a target. It is unfortunate that the author does not think more highly of ALPHA OMEGA; the game is an excellent simulation of space

Continued on page 34



YAQUINTO PUBLICATIONS TO UNVEIL NEW ERA OF WARGAMING AT ORIGINS '79.



ALL NEW TITLES! ALL NEW ADVENTURES! ALL NEW CHALLENGES!
From the newest old hands in wargame design.

Yaquinto Publications is set to unveil the battlefields of the future at ORIGINS '79.

Conflicts as endless as your imagination. Challenges that encompass combat from the stone age to the stars, and beyond. (Under the banner of Yaquinto Publications, Craig (WOODEN SHIPS AND IRON MEN) Taylor and Steve (SUBMARINE) Peek combine forces, and over a decade of professional game design, to

create new wars and worlds for you to conquer.

Craig and Steve have produced some of the most popular wargames of the last decade, including:

FURY IN THE WEST — ALPHA OMEGA
DAUNTLESS — SHENANDOAH
AIR FORCE — FLAT TOP

Now, together, as Yaquinto Publications, they're ready to introduce you to the most exciting and realistic gaming experiences imaginable. What

does the future hold in store for you? If you can't wait for the wraps to come off at ORIGINS '79, you can get a sneak preview of the new era of wargaming by writing to Craig and Steve in care of:

**YAQUINTO PUBLICATIONS
POST OFFICE BOX 24767
DALLAS, TEXAS 75224**

Dealer inquiries invited.

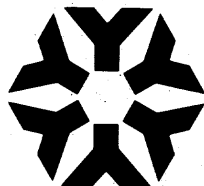

YAQUINTO PUBLICATIONS, MAKING HISTORY UNFOLD BEFORE YOUR EYES.

ARMIES OF THE RENAISSANCE

Nick Nascati

Part III — The Condotierre and The Papacy

If Woody Allen would ever decide to turn his comedic talents to writing history, the result would very probably read like a history of Italy in the Age of the Condotierre. Few periods in history could possibly be as full of petty squabbles and pointless maneuvering, as this age when greedy, mercenary captains controlled the destiny of the Italian City-States. Warfare was formalized to the point where it almost became a life-size chess match, with few fatalities. However, their military system does assume a certain importance in our study of the period.

With few exceptions, which will be discussed, the majority of the city-state forces, consisted of high priced, un-enthusiastic condotierre mercenaries. The Condotierre captains, realizing how expensive a commodity they had to offer, strove constantly to find a way to reduce casualties in battle, and increase the number of wealthy, ransomable, prisoners. Naturally the first way to reduce casualties, is to arm men so heavily that it becomes almost impossible to kill them. This resulted in armies moving slower and slower, a full charge being almost impossible. The lack of movement eventually resulted in battles becoming a series of intricate maneuvers, where the primary objective would be to force your opponent into an untenable position, where he would either have to surrender, or be cut down by crossbowmen, whose heavy bolts could penetrate the heaviest armor.

Later, when the need for mobility was realized, the Condotierre captains began to employ a type of light cavalryman known as a Stradiot. The Stradiot served essentially as a dragoon, trained to fight on horse or foot, and very useful for scouting and skirmishing. The infantry of the Condotierre companies consisted almost entirely of lightly armored missile troops. Crossbows tended to be the most common weapon, with longbows used occasionally, and later on, small numbers of handguns found their way into the formation. One quite notable exception to the norm, was the famous White Company of Sir John Hawkwood. This force of English mercenaries, consisted of its height of 2,000 longbowmen, many veterans of the French Wars, and 2,000 mounted men at arms. They were well known for their bravery and outstanding service to their employers.

The native forces of the individual city-states, consisted almost entirely of infantry, and varied in quality from miserable to decent. Machiavelli's famous experiments with the Pisan militia, showed that locally raised levies could be made into a competent fighting force, when adequately trained and led. Generally, the levies were armed with a variety of polearms, glaives, bills and halberds being common. The amount of armor depended on the wealth of the city, and the particular

way in which the troops were used. Garrison troops tended to be more heavily armored than field troops. The forces of the more powerful cities, Genoa, Venice, Milan and Florence, tended to be a bit more competent than most. The Genoese crossbowmen had of course built up a fair reputation for skill in France, and were considered prize troops. Generalship on the whole, was not outstanding, the Sforzas, the Borgias, and the Medici were about the best that could be found, though they could hardly be called great captains. Machiavelli was the pre-eminent tactician and strategist of the day, but he was more concerned with matters of state, not commanding armies in the field. His "Art of War," is a classic work, but unfortunately was not read widely enough by his contemporaries.

The use of artillery was virtually non-existent, until the lessons of the French invasion in 1490, taught them the value of cannon. Even the Venetians still used Greek-Fire on their galleys, and only mounted small pieces of cannon for close fighting. Interestingly though, it was an Italian, Niccolo Tartaglia, who invented the gunner's quadrant in the later 16th century, that enabled artillerymen to set range and trajectory more accurately. Inventiveness was certainly not lacking in the minds of Italian thinkers, for DaVinci's notebooks are full of ingenious and highly advanced military weapons, and most Italian artists dabbled to a degree, in military affairs.

There is a tremendous paradox in Italian affairs in this era, in that the most powerful and most militaristic of all the rulers was the Pope, the representative of God on earth, the most "peace" loving of all men. In reality though, the Papal States presented a tight confederation of vassals, who swore undying loyalty to the Pope. The two Popes who figured most greatly in this era, Gregory and Alexander, were masters of political intrigue and manipulation of petty nobles. The core of the Papal forces was the Pope's personal guard of Swiss mercenaries. Their loyalty was legendary, and they provided unshakable support to the less reliable levies of the Pope's vassals.

As for costume, this is a very fertile era for the imagination. The mercenary companies generally wore some sort of uniform dress or at least colors, according to the whim of the captain. Hawkwood's White Company, as its name implies, wore white surcoats emblazoned with a red cross of St. George. The city-states generally fielded levies dressed in their ordinary clothing, embellished with armor, and usually gave them some type of sign to wear taken from the city coat of arms.

The Italian forces then, should not be ignored in games set in the earlier Renaissance, and when painted with imagination, they can provide a tremendously colorful spectacle on the wargame table.
Next Time: The English from St. Albans to The Boyne

watch out for. . .

STOMP!

\$3.00 postpaid.

CHAOSIUM BOX 6302 ALBANY CA 94706



BACK ISSUE AVAILABILITY

Some back issues of TD are still available. Only those listed below are in stock. Back issue price is \$2.10, postage and handling are included.

| | |
|----------------|-----------------|
| Vol. II | Vol. III |
| TD 7 | TD 15 TD 23 |
| TD 8 | TD 18 TD 24 |
| TD 12 | TD 19 |
| TD 13 | TD 20 |
| | TD 21 |
| | TD 22 |

All issues are of limited quantity. No guarantees of availability are implied.

DICE • FANCY 8 SIDED FANTASY DICE •
ROUNDED EDGES • DURABLE QUALITY
DICE FOR PLAYERS AND COLLECTORS

Send to • **MERCHANTS ROW CO.**, 92 State St., Boston, Ma. 02109
Ck. or M.O. • **\$1.49 ea. OR \$2.65/pr.** (+ 28¢ postage) Ma. res. add 5% tx. M.B.G.

"NICE DICE"



GAMING MARATHON

Can't sleep? Want more gaming? Starting 11 a.m.
May 26th thru 5 p.m. May 27th—30 hours
of war gaming to celebrate our 3rd Birthday.

SAVE 10% OFF
during our party!

Phone 201-437-9618 and sign up for a game!

• WARGAME MINIATURES & SUPPLIES
• MAGAZINES • POSTERS • MILITARIA

BOOTS & SADDLES
MILITARY HOBBIES

791 BROADWAY, BAYONNE, N.J.

Exit 14A N.J. Turnpike

Sorry No Mail Orders

WOULD THE REAL ORC PLEASE STEP FORWARD?

Dealing With the Proliferation of Orcish Miniatures

by Lance Harrop

Representing as they do the bulk of any evil army, orcs are very important to the fantasy miniaturist; but since the actual appearance of an orc is a matter of opinion, the gamer is forced to choose among a wide variety of styles to obtain his orcs. The only source on orcs that I know of is LOTR, and Tolkien left wide room for interpretation. Because of this the miniaturist must make his own interpretation in the end.

But before you, the present or prospective fantasy miniaturist, make your final choice, consider the following ideas.

Orcish Genealogy and Taxonomy

Orcs are a member of a "family" of evil creatures; kobolds, goblins, hobgoblins, orcs, and ogres. Gnolls and trolls are closely related to each other, but not to the "goblin races." Their evolutionary progress might be like this:

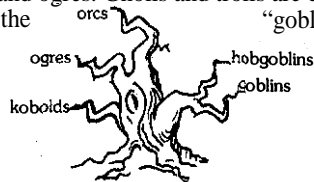

Orcs are themselves a genus of various species, subspecies, and breeds. No two orcs need look alike any more than a Basset Hound looks like a St. Bernard. Of course there are limits to size, build and cast of face which exclude some makes of orcs, but under this system most every type of orc, goblin, hobgoblin, ogre, and kobold can be included.

It is also useful to break the genus *orkus* into three main species; *Orkus Superus*, the Great orcs and Uruk-hai of Mordor; *Orkus commus*, the lesser and snaga orcs; and *Orkus Homus*, the half orcs or man orcs. *Orkus homus* is a contrived name as every tribe of man orcs had to be specially bred by some powerful evil magician, and the tribes can't generally inter-breed.

Using this system, most makes of orcs would fit below.

Genus Koboldus- Kobolds -up to four feet tall (20 mm).

Kobolds are extremely small and wiry creatures, much like Golum. They live in small hills for which possession they war with gnomes. They hate the sun more for its denying them hiding places than for the light itself.

Genus Ogrus- Ogres- six feet plus tall (30 mm and up).

Any very large and ugly creature that isn't a gnoll or troll is an ogre. Ogres can get to be as tall as giants. Ogres are often found in confederation with orcs.

Genus Goblus- Goblins-three to five feet tall (15-25 mm).

Goblins are small man-like creatures, ugly and fanged. They live in mountains in alliances with hobgoblins. They don't like dwarves and dwarves don't like them.

Genus Hoblus- hobgoblins-five to seven feet tall (25-35 mm).

Hobgoblins are simply large goblins. In many tribes the ruling members finally differentiated into hobgoblins. Hobgoblins share the hatred of dwarves but they're smart enough not to attack without thinking.

Genus Orkus- Orcs

Orkus Commus- Lesser orcs-up to four feet tall (20 mm).

Small, broad, longarmed and hideous, lesser orcs comprise the bulk of most evil armies. They normally live in mountains. They don't like elves, dwarves, men, the outside, the light, or each other.

Orkus superus- Great Orcs-four to six feet (20-30 mm).

Large, broad, longarmed and hideous, great orcs tend to be better in a fight, and perform more militarily.

*Orkus homus -*Man Orcs-five or six feet tall (25-30 mm).

Man orcs tend to have more human proportions than other orcs. They also suffer the light better and fight in military formations.

Remember that the smaller goblin races often ride wargs, very large corrupted wolves (corrupted because I like to think of wolves as basically good, in the *Jungle Book* traditions). Larger races may ride other mounts.

Makes of Orcs

I list below most major makes of orcs and related races and how I apply this system to them.

Miniature Figurines (Middle Earth) — ME 1, 9, 41 — *Man orcs, great orcs.*

Good luck on finding any of these figures, I think the line is discontinued, but they are good figures for man orcs, carrying large shields and wearing full chain. Highly adaptable for the shield is blank.

Mini Figs — ME 24, 25, 45 — *True orcs, Snaga orcs.*

These are of the same line as above, so they may be hard to get. The figures are all together too small for orcs, they make better kobolds.

Mini Figs-ME 15, 16, 50 — *Goblins.*

Again these figures are too small for goblins, but they make excellent kobolds. Since the first two are mounted on wargs they give the kobolds an effective cavalry arm.

Mini Figs -ME 56 — *Large Goblin.*

This figure can be used as a goblin, man orc, or as I do, a very large kobold.

Mini Figs -ME 11, 31- *Trolls.*

Use these figures as hobgoblins or ogres.

Heritage-Fantastiques 1000-1003 — *Snaga Orcs.*

These figures are best used as snaga orcs, but their broad grins, sometimes known as "snaga smiles" tend to make them appear farcical. Otherwise they are good figures, coming in many poses and weapons, their shields are blank as well.

Heritage-Fantastiques 1004-1006 — *Man orcs.*

These figures can be used as great orcs or hobgoblins, but they don't make good man orcs.

Heritage-Fantastiques 1007-1009 — *Great Orcs.*

These are without a doubt the best orcs anyone has cast, their intensely evil aspect and their military outfitting make them excellent great orcs.

Heritage-Fantastiques 1010-1014, 1020 — *Goblins.*

Most of my conceptions of goblin races are based on the *Fantastiques* line, so I view these as model goblins. Note that some are mounted on wargs.

Heritage-Fantastiques 1015-1019 — *Trolls.*

Tolkien's trolls are *D&D's* ogres, use these figures as such, with the possible exception of 1016, which could be a true troll.

Heritage-Fantastiques 1027 — *Variags of Khan?*

When I finally identified these figures I had used them as something else. They can be man orcs, hobgoblins or orcs.

Ral Partha- Warriors, Wizards and Warlocks 611, 612, 613, 621, 622, 623, 631, 632, 651, 652, EW 641, 642- *Snaga Orcs, Great Orcs, and Goblins.*

I have been told that these figures resemble beardless dwarves, in any case they are excellent for orcs, great and lesser; but don't use the goblins as goblins, but as more orcs.

Grenadier- Wizards and Warriors W15-18 Orcs.

From what I have seen these are fairly good orcs.

Grenadier- Wizards and Warriors W19-21 — *Goblins.*

Again these appear to be good goblins.

Garrison — *SS 77* — *Great Orcs.*

These figures are too small and skinny to be great orcs; use them as man orcs.

Mini Figs — *D&D set 7* — *goblins.*

These seem to be good goblins, though they may be so small that I would use them as kobolds.

Mini Figs — *D&D set 8-10* — *Hobgoblins.*

These are best used as hobgoblins, they don't fit any other role.

Mini Figs — *D&D set 11-13* — *Orcs.*

Much as I like Dave Sutherland's work, pigs are not my idea of orcs, so if I ever buy these figures, and no doubt I will, I'll use them as were-boards.

Mini Figs — D&D set 16 — Kobolds.

Again these figures look too much like animals, I'd use them as were-jacks.

Archive Miniatures — 513-515, 518-520 — Goblins.

These are small but passable goblins, the last three are mounted on wargs.

Archive Miniatures — 524-530, 541-543 — Low Orcs.

Low is right, these are bad for orcs, like Mini Figs' D&D orcs, these have ridiculous snouts; I use them for what they look like, lizardmen.

Archive Miniatures — 535-536 — Orcs.

These figures are like Archive's, low orcs, lizard snouted; I use them for superior lizardmen.

Archive Miniatures — 630 — Boar Troll.

I use this figure for a hobgoblin to go with Archive's other goblins, note that the figure is mounted on a very large boar.

Heritage-Lord of the Ring Miniatures — Orcs.

These figures are certainly a departure from the common conception of orcdom. They are easily hideous enough for orcs, in fact they are almost comically ugly. Their large size and completely inhuman aspect makes them useful only as great orcs, despite the fact that some are labeled as a man orcs. One figure is mounted on a horse, which is passably strange for an orc. The line would be greatly improved with the addition of smaller orcs, warg riders, and some more human man orcs.

No doubt I have left out some makes of orcs, for which I apologize, but I'm sure you can fit them into the system. Of course all these ideas are just suggestions, it is your opinion in the end that matters.

Painting Orcs

These are a few guides to painting orcish armies to keep in mind while you work.

1. An orcish tribe is a race of orcs, or a breed; they tend to look like each other and unlike other orcs, so use one line of figures in a tribe and paint them all the same flesh colour.
2. An orc can have any colour flesh that you want, use browns, brownish-yellows, reddish-browns, greens, dark reds, and black.
3. Major evil nations, Mordor and Isengard for instance, are multitribal. The orcs of Moria could be of more than one tribe, but it is doubtful. The

same with Minas Morgul and Cirith Ungol. The orcs of the Misty Mountains were a confederation under one powerful great orc, probably supported by the balrog of Moria.

4. Don't dress your orcs in black or red; greens and browns should predominate, with some grays, stay away from bright yellow, medium and light blues, orange and white.
5. Use dark metals, not silver, brass or gold, and use tan and brown leathers, black leather has to be dyed and orcs would not waste the time, they're not out for aesthetics.
6. Disregard 4 and 5 when painting elite units, though they would still not use bright metals.
7. Orcs' teeth are white for the same reason dogs' are; because they chew bones.
8. Orcish colours and standards are usually black and red, with some browns, greens and dark metals, other colours are anathema. The White Hand of Isengard is a Wizard's symbol, not an orc's
9. Three major problems obstruct the use of orcs' shields for symbolism, sculptured shields, central spikes, and raised emblems, all of which can be filed off if necessary.
10. Avoid using raised symbols with different colours, it rarely looks good.

Gaming Orcs

Again here are some guides to using orcs on the battlefield.

1. All goblin races dislike the sunlight, so lower their morale in the daytime.
2. Kobolds and Gnomes will almost instantly attack each other, so have them make obedience checks when they are in charging distance. The same with goblins and dwarves and lesser orcs and elves. Great orcs, man orcs, ogres and hobgoblins will not generally disobey.
3. Orcs of different tribes will also attack each other, as will all goblin races, but powerful leaders can keep them in check, so adjust the die roll against the level of the leader.
4. Usually only great orcs and man orcs will fight in formations, the others will fight *en masse*.

Good wargaming and may your Enemy's orcs disobey before yours.

Front Line Left to Right *Mini Fig ME* snaga orc, *Heritage LOTR* orc, *Mini Fig ME* man orc, *Heritage Fant.* great orc, *Heritage Fant.* snaga orc, *Ral Partha* great orc, *Archive* goblin. Rear line, *Heritage Fant.* man orc, *Heritage Fant.* warg rider, *Archive* orc, *Garrison*



THE TRAVELLER NAVY WANTS TO JOIN YOU: New Service Opportunities for Navy Characters

R.D. Stuart

With the success of GDWs *Mercenary* supplement to their *Traveller* game system players generating Army and Marine personnel now have a wide range of skills and expertise areas from which to produce well-rounded characters. While *Mercenary* leaves the "ground pounders" in fair shape, other Traveller services can occasionally appear lacklustre in comparison.

Given the importance of any future naval institution capable of insuring security over interstellar distances, it seems only fitting that the naval arm in *Traveller* be given equal time. The following therefore is a proposed variant on the standard method used to generate naval personnel in *Traveller*, utilizing the same format as in *Mercenary*, with the following changes and additions.

Any character choosing (or drafted into) the navy must choose a branch of that arm in which to serve: Ship's Complement Support Services, or Security. Skills are attained by completing yearly assignments with occasional throws for survival, commissioning, promotion, etc. Ranks for enlisted men and officers are given by the following tables. Note that two additional officer ranks between Captain and Admiral have been added.

Skills acquired are identical to those presented in Booklet One, with the following additions specifically for naval personnel:

Jump-Drive: Expertise in hyper-atomic physics and propulsion systems for space flight

Fleet Tactics: Strategic & Tactical handling of fleet warships in combat conditions

Wenching: Basic Carousing. Can also be used as a DM+ Level against Reaction Table when non-player character is of the opposite sex.

Decorations are awarded to naval personnel as follows: on the exact die roll required, player is awarded the *Naval Star of Bravery*. On a DR of + 1 required, player is awarded the *Sunburst for Conspicuous Gallantry*. If DR +2 is achieved the player is awarded the *Naval Cluster for Heroism*.

In the course of their four-year terms of duty players will draw either routine fleet or special assignments. NOTE: The first assignment of any player consists of one-year basic training & advanced service training. Players must successfully throw against a survival roll, as per *Mercenary*, and receive a basic + 1 Blade Combat as an addition to their N.O.T. roll an advanced skill.

It is hoped that in utilizing this variant players and referee will now be able to generate characters able to compete with specialized army and marine personnel already on hand. And while naval starmen are not generally considered for *Mercenary* assignments, specialized characters can of course apply for deep-space exploration teams, colonizing efforts, and a host of other possibilities. Given skills and a little imagination on the players' behalf no doubt new and rewarding gaming opportunities will occur. And so, now, the *Traveller* navy is ready to join you!

NAVAL OCCUPATION TABLE

| Die Roll | Ship's Complement | Support Services | Security |
|----------|-------------------|------------------|--------------|
| 1 | Ship's Boat | Steward | Bld. Combat |
| 2 | Vac. Suit | F.O. | Gn. Combat |
| 3 | Gunnery | Medical | Gn. Combat |
| 4 | Mechanical | Engineering | Vac. Suit |
| 5 | Jack-O-Trades | Computer | Survival |
| 6 | Navigation | Electronics | Zero—G |
| 7 | Pilot | Jump Drive | Battle Dress |

DM (+ 1) If Tech Level of world is 12 +

RANKS

Enlisted Men

| | |
|---------------------|---------------------------------|
| S1 Starman | 01 Ensign (Trav. Rank 1) |
| S2 Starman II class | 02 Lieutenant (Trav. Rank 2) |
| S3 Starman I class | 03 Lt.-Commander (Trav. Rank 3) |
| S4 Starman (Chief) | 04 Commander (Trav. Rank 4) |

| | |
|----------------------------|---------------------------------|
| S5 Starman (Gunnery Chief) | 05 Captain (Trav. Rank 5) |
| S6 Starman (Ship's Chief) | 06 Commodore (Trav. Rank 5) |
| S7 Starrman (Master Chief) | 07 Fleet Captain (Trav. Rank 6) |
| S8 Starman (Fleet Chief) | 08 Admiral (Trav. Rank 6) |

SKILL TABLES

| Die Roll | Navy Life | Chief Skills | Command Skills | Staff |
|----------|-----------|--------------|----------------|---------------|
| 1 | +1 Str | Gn. Cmbt. | Navigation | F.O. |
| 2 | +1 Dex | Navigation | Computer | Medical |
| 3 | +1 End | Jump Drive | Leadership | Fleet Tactics |
| 4 | +1 Itell | Instruction | Leadership | Mechanical |
| 5 | Gambling | Leadership | Fleet Tactics | Admin |
| 6 | Wenching | Gunnery | Pilot | Admin |
| 7 | Brawling | Admin | +1 Soc | +1 Soc |
| 8 | Bld. Cmbt | +1 Soc | +1 Soc | +1 Soc |

Navy Life: 01 +1, 02 +2, 03 Above +3

Chief Skills: S4 + 1, S5 + 2, S6+3, S7+4, S8 +5

Command/Staff Skills: Rank 3-4 + 1, Rank 5-6 +2

Above modifiers are optional at player's discretion

GENERAL ASSIGNMENT

| Die Roll | Ship's Complement | Support Services | Security |
|----------|-------------------|------------------|----------|
| 1 | Command | Command | Command |
| 2 | Command | Command | Command |
| 3 | Command | Staff | Staff |
| 4 | Command | Staff | Staff |
| 5 | Staff | Staff | Special |
| 6 | Special | Special | Special |
| 7 | Special | Special | Special |

AU except officers treat Command and Staff Rolls as Fleet assignments.

DM (+) Education 9 + allowed

Officers may choose DM (-1)

FLEET ASSIGNMENT

| Die Roll | Ship's Complement | Support Services | Security |
|----------|-------------------|-------------------|----------------|
| 2 | Raid | Raid | Raid |
| 3 | Raid | Fleet Act. | Raid |
| 4 | Anti-Piracy | Planetary Support | Raid |
| 5 | Refit & Repair | Patrol | Fleet Action |
| 6 | Refit & Repair | Refit & Repair | Fleet Action |
| 7 | Refit & Repair | Refit & Repair | Patrol |
| 8 | Patrol | Patrol | Patrol |
| 9 | Patrol | Exploration | Patrol |
| 10 | Patrol | Planetary Support | Refit & Repair |
| 11 | Fleet Action | Planetary Support | Refit & Repair |
| 12 | Fleet Action | Patrol | Exploration |

DEFINITIONS

Raid Raid on planetary system in conjunction with other military support

Anti-Piracy Ship assignment against commerce raiders

Patrol Protection of planetary systems and normal space lanes

Exploration Mapping expedition — survey of uncharted planet system

Planetary Support.: Planetary Support to established colonies or naval installations.

Refit & Repair Refitting, drydocking, repair of vessel, relaxation, rest leave for ship's crew

SPECIAL ASSIGNMENT

| Die Roll | Enlisted Men & Chiefs | Officers |
|----------|-----------------------|-----------------------|
| 1 | Recruiting | Recruiting |
| 2 | Cross Training | Naval Intelligence |
| 3 | Protected Forces | Fleet Command School |
| 4 | Specialist School | Staff School |
| 5 | Marine Attach. | Marine Attach. |
| 6 | O.C.S. | Military Aide/Attaché |
| 7 | O.C.S. | Fighter Command |

FLEET ASSIGNMENT RESOLUTION

| | <i>Fleet Act.</i> | <i>Raid</i> | <i>Ant.-Piracy</i> | <i>Patrol</i> |
|------------|-------------------|-------------|--------------------|---------------|
| Survival | 6+ | 5+ | 4+ | 4+ |
| Decoration | 8+ | 9+ | 10+ | 12+ |
| Promotion | 6+ | 7+ | 7+ | (8+) |
| Skills | 5+ | 6+ | 6+ | 7+ |

| | <i>Exploration</i> | <i>Refit & Repair (auto)</i> | <i>Planet. Supprt. (auto)</i> |
|------------|--------------------|----------------------------------|-------------------------------|
| Survival | 6+ | none | 10+ |
| Decoration | 9+ | none | (8+) |
| Promotion | 9+ | 8+ | 5+ |
| Skills | 7+ | | |

Players add DM+1 on survival throws if any N.O.T. skill is level 2 or greater

For promotion Rolls (8+) add DM+ 1 if Education is 9+

SPECIAL ASSIGNMENT RESOLUTION

Die Roll *Enlisted Men and Chiefs* Enlisted Men DM + 1 if educated past level 8

1. *Recruiting* Player has been given a recruiting assignment and receives an automatic Recruiting Level + 1
2. *Cross Training* Player may have his character cross train either of the two branches not originally selected, receiving a die roll that branch N.O.T. Table.
3. *Protected Forces Training* Player rolls for following skills, received on 4+: Zero-G Cmbt., Vac. Suit, on one die.
4. *Specialist School* Player has been sent to specialist school. Roll one die and receive skill level in the following areas:
 1. Communications
 2. Admin
 3. Medical
 4. Electronics
 5. Jump-Drive
 6. Computer
5. *Marine Attachment:* Player has been temporarily assigned to a Marine regiment for a yearly assignment. Roll 4+ on one die for the following skills: + 1 Gun Cmbt., +1 Bld. Cmbt., + 1 Hvy. Weapons.

- 6-7. *O.C.S.* Player has been selected for Officers' Candidate School. Roll 4+ on one die for additional Navy Life or NOT Table Skill. Roll one die automatically for one Command and one Staff Skill. After completion of assignment player is commissioned as an Ensign.

Officers Officers add DM+ 1 if Intelligence is better than 9

1. *Recruiting:* Officer receives same assignment as enlisted men. Officer receives automatic + 1 Recruiting skill for this one-year assignment.
2. *Naval Intelligence:* Officer has been posted to Naval Intelligence School. Roll 5+ on two dice for following skills: Interrogation, Forgery, Bribery, Fleet Tactics.
3. *Fleet Command School:* Roll 5+ on two dice for following skills: Fleet Tactics, Leadership, Navigation, Jump Drive. If three skills are successfully rolled player may roll 10+ on two dice for promotion.
4. *Staff School:* Roll 4+ on one die for the following skills: Admin, Computer, Electronics
5. *Marine Attachment:* Same as enlisted men, officer rolls 5+ on one die for the following skills + 1 Gn Cmbt., + 1 Bld. Cmbt., + 1 Ground Tactics
6. *Military Aide/Attache:* Officer rolls one die DR 1-4 player has been posted as naval attache, receives automatic promotion and + 1 Soc. level 5-6 player is posted to aide for Admiral and may select own special assignment for next term other than a continuing aide assignment.
7. *Fighter Command:* Officer has been posted to navy special fighter command. Player receives an automatic promotion and + 1 Fighter skill. Player must immediately roll survival throw of (6+) DM per prior number fighter assignments only. Player may attempt to continue assignment next term if DR 10+ on two dice achieved. (No reenlistment roll required if this assignment last in current term and 10+ DR achieved).

Judges Guild

WELCOMES YOU TO THE



- 88 **DARK TOWER** by Paul Jaquays. Huge dungeon adventure described as "The best from Judges Guild to date." Many pages of background, descriptions, unique monsters, and dungeon levels. Approved for use with Advanced Dungeons & Dragons® \$5.50
- 78 **THE TRAVELLER LOGBOOK** by Dave Sering. A playing aid designed to assist referees and players in the generation of characters and the design of spaceships. Record keeping forms and tables provide backgrounds and personal characteristics for player and non-player characters. Includes financial operation tables for starships. Although designed and approved to mesh with the TRAVELLER GAME SYSTEM®, the material herein may be utilized with any science fiction role playing system. \$3.00
- 87 **CHARACTER CODEX** Over 90 sheets of perforated character record sheets. Includes equipment cost. Approved for use with Advanced Dungeons & Dragons®. \$4.50
- 89 **STARSHIPS & SPACECRAFTS** by Dave Sering. Three huge 22" x 34" detailed plans in 3 colors of the standard ships approved for use with TRAVELLER®. Includes all specs and room for designing your own. \$5.50
- 92 **WILDERLANDS OF THE MAGIC REALM** by Mark Holmer. Two 16-page booklets describe the villages, ruins and relics, castles and citadels, and the isles. Includes four 17" x 22" maps (2 players and 2 judges) of "Ghinor", "Isle of the Blest", "Ebony Coast", and "Ament Tundra". Approved for use with Dungeons & Dragons® \$8.50
- 93 **UNDER THE STORM GIANT'S CASTLE** by Tim McCloud. Six levels of dungeon beneath a "Castle in the Clouds". Unique monsters and descriptions. Approved for use with Advanced Dungeons & Dragons® \$3.00

Judges Guild
 1165 N. University Ave. (N2)
 Decatur, IL, 62526
 (217) 422-1930

GENCON



University of Wisconsin-Parkside
August 16-19, 1979

Dealers... Seminars... Boardgames!
Giant *Dungeon and D&D*® Tournaments!
Miniatures... Role Playing... New Game Releases!

Everything You Ever Wanted In A Game Convention And More!

Each Conventioneer Will Receive a Book of Coupons Worth
\$10 Redeemable With Any Dealer in the Exhibit Area

\$10.00 Pre-Registration Fee Before July 25 - \$15.00 At Door
For More Information Contact: GENCON XII, POB 756, Lake Geneva WI 53147



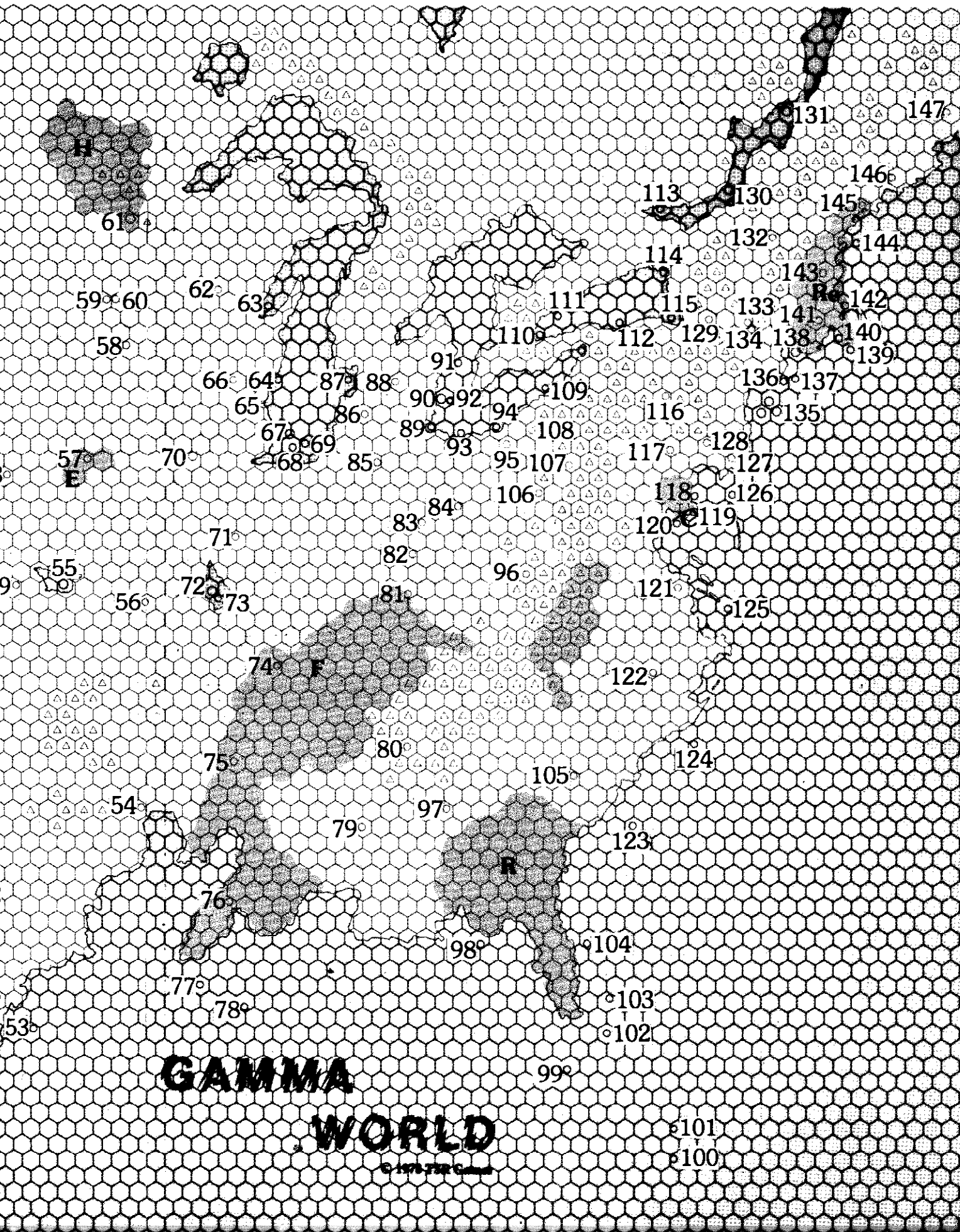

GAMMA WORLD

© 1974 TSR Games

GAMMA WORLD ARTIFACT USE CHART

by Gay Jaquet

One of the more frequent criticisms of *Gamma World* is the Artifact Use Chart—and the criticism is somewhat justified. It can be mildly interesting to watch one's progress towards successfully learning the workings of an artifact (only to see the final roll result in a skull and crossbones), but it serves little purpose. The chart could easily be pre-calculated and the possible pathways computed to single percentage rolls. Therefore, I offer a new system for determining the use of *Gamma World* artifacts.

The new Artifact Use Chart appears on the opposite page — it is somewhat similar to the old chart, but it is used in a different manner. One still rolls dice and follows the indicated path, but there are also provisions for players to make actual decisions during the process.

To use the chart, a player starts at one of the numbered squares, the larger numbers representing more complex devices. In terms of the "old" charts, square 1 is roughly equal to chart A, square 3 equals chart B, and square 5 equals chart C. Squares 2 and 4 are provided to allow for additional referee discretion in determining the complexity of artifacts. As with the old charts, the player rolls a single 10-sided die and follows the indicated path.

As the player follows the pathways, squares represent "correct" steps taken towards operation of the artifact. Diamonds represent incorrect steps, short cuts, omissions, etc. Generally, there is a greater chance for a "failure" from a diamond than from a square. A circle represents a failure in the operation procedure. A failure can range from simply spoiling the previous step and forcing the player to start again, to causing extensive damage. Each circle is identified by a letter, and the type of failure is determined by rolling on the table indicated by the letter. Upon reaching the square containing the asterisk, the use and operation of the artifact has been successfully determined.

As with the old charts, a player receives five dice rolls per hour of total concentration on the artifact, and each additional player concentrating adds one die roll per hour. Die rolls are modified with respect to intelligence and mutations as with the old charts.

Thus far, even with the large number of possible pathways on the chart, successful operation of an artifact could still be determined by a simple percentage roll. But this is where player choice comes in. Each time a player attempts to determine the use of an artifact, he starts with a number of "artifact use points" equal to his intelligence. At the cost of some of these points, a player may choose the path he takes on the chart. Choosing a path out of a square costs four points, choosing a path out of a diamond costs two points. Points are not cumulative, replaceable, or transferable in any way. They exist only for a single attempt by a single player at determining the use and operation of an artifact. These choices may be made any time during the overall process of attempting to learn artifact operation, *before* the die roll for a given square of diamond. (As an option, referees may even allow choice of "failure" roll after entering a circle. Cost: six points)

Whenever a player decides to *choose* the path taken on the chart, rather than roll the die, there is no time penalty. (The choice represents an intuitive decision or hunch, rather than study.) Thus a character can spend an hour concentrating on an artifact, roll the die the maximum allowed five times, and (assuming he has an intelligence of 16) choose paths through four *more* squares, all in the same hour. Of course, then he has used up all his artifact use points for this attempt, and if operation and use has still not been determined, he will be left to the mercy of the die rolls until he either discovers the operation of the device or quits.

A glance at the chart will show there are several strategic points where judicious use of the artifact use points and selection of certain paths can be of great advantage towards learning the operation of an artifact. Of course, it is also nice to hold the points in reserve, in case a string of bad die rolls leads off the optimum path and towards an area of high failure risk.

While admittedly this method of determining the use and operation of artifacts is somewhat abstract, it does give the players a chance to use some of their own logic, hunches, or daring in the process, but at the same time (through the artifact use points) ties the process to the "abilities" of his character.

FAILURE TABLE

| die roll | a | b | c | d |
|----------|-------|-------|-------|-------|
| 1 | NE | NE | NE | NE |
| 2 | NE | NE | NE | D |
| 3 | NE | NE | D | X 1d6 |
| 4 | NE | D | D | X 2d6 |
| 5 | NE | D | D | X 2d6 |
| 6 | D | D | X 1d6 | X 3d6 |
| 7 | D | X 1d6 | X 2d6 | X 3d6 |
| 8 | D | X 1d6 | X 2d6 | X 4d6 |
| 9 | D | X 1d6 | X 3d6 | X max |
| 10 | X 1d6 | X 2d6 | X 4d6 | X max |

20th CENTURY PRIMITIVE

Perhaps one of the most difficult situations encountered when refereeing *Gamma World* is that of characters with a primitive technology discovering advanced technology devices. Players will often have a character with 13th century knowledge react in a 20th century manner to a 24th century device . . .

Player: "OK, we beat down the door with the log and hold our spears ready as it falls in. What do we see?"

Referee: "You see a low bench or table with a small box or chest on it. The box has a smooth, sort of clear front — it might remind you of looking into a pool of water. Beneath it is a smaller box with several bead-like objects set in even rows across it. The beads have strange markings on them — each one different."

Player: "I get on-line and type 'CALL DUMP MEMORY.' Everyone else looks for laser pistols and control batons. By the way, is there anything around here that looks like this might be a military security check-point. . .?"

Well, perhaps I've exaggerated a bit, but maintaining a perspective on the consistency of the knowledge of the players, especially at the beginning of a campaign, is a problem. Many referees simply start the player/characters at a 20th century knowledge level and avoid the hassle, but to me, that's placing an unfortunate limit on the scope of the game, and tends to turn it into an exercise in collecting exotic weapons of destruction.

Forcing players to maintain a low technology base, at least at the beginning of the campaign, also forces them to deal with situations in a more challenging and creative manner than the old "bomb it, pave it, paint some lines on it and turn it into a parking lot" method.

Primitive characters need not be stupid — indeed, in the game format, they are the elite of their culture: adventurous, skillful, intelligent, able to make logical decisions and learn quickly from their mistakes. All that is necessary is a little sincerity on the part of the players in playing their characters as they could realistically expect them to behave. The referee can help this process by taking the time to consider how the ruined world of the 24th century would appear to a primitive, and by describing it accordingly.

High level technology, to primitives, is, for all practical purposes, magic. This does not imply a need for human sacrifices to the God of the Nightlight, just a lack of knowledge as to the power behind the function. One need not know the workings of a generator to turn on a light switch.

What this boils down to, is, in the early stages of a *Gamma World* campaign, the referee (in addition to his simple descriptions) should allow his player/characters to witness various uses of the technological devices about themselves, and learn from experience. They may not know, initially, exactly what they are doing, but they will know the results to expect. Indeed, this concept must be used not only as primitive characters discover 20th century technology, but also as characters with 20th century knowledge discover 24th century technology.

There is a sense of "reality" to be considered (if that term can be applied to a science fiction role-playing game) in conducting a *Gamma World* campaign. Question it. Would you, as an average 20th century man, walk into the control room at Hoover Dam and start throwing switches for no reason, other than to see what happens? How 'bout finding yourself in SAC headquarters? Would you start typing "CALL DUMP MEMORY" on a computer terminal?

Not only does the use of a primitive technology level provide a logical starting point, it also can add a sense of "reality" to an admittedly unreal situation. It's all up to the referee.

FAILURE TABLE RESULTS

- NE No effect —
- Return to previously occupied space
- D Artifact damaged —
- Roll percentile dice to determine point of damage to artifact — character may resume trying to determine operation and use of artifact by returning to previously occupied space
- X Artifact malfunctions —
- Causes damage to all within applicable range in amount indicated, from 1d6 to the maximum amount of energy stored within the artifact.

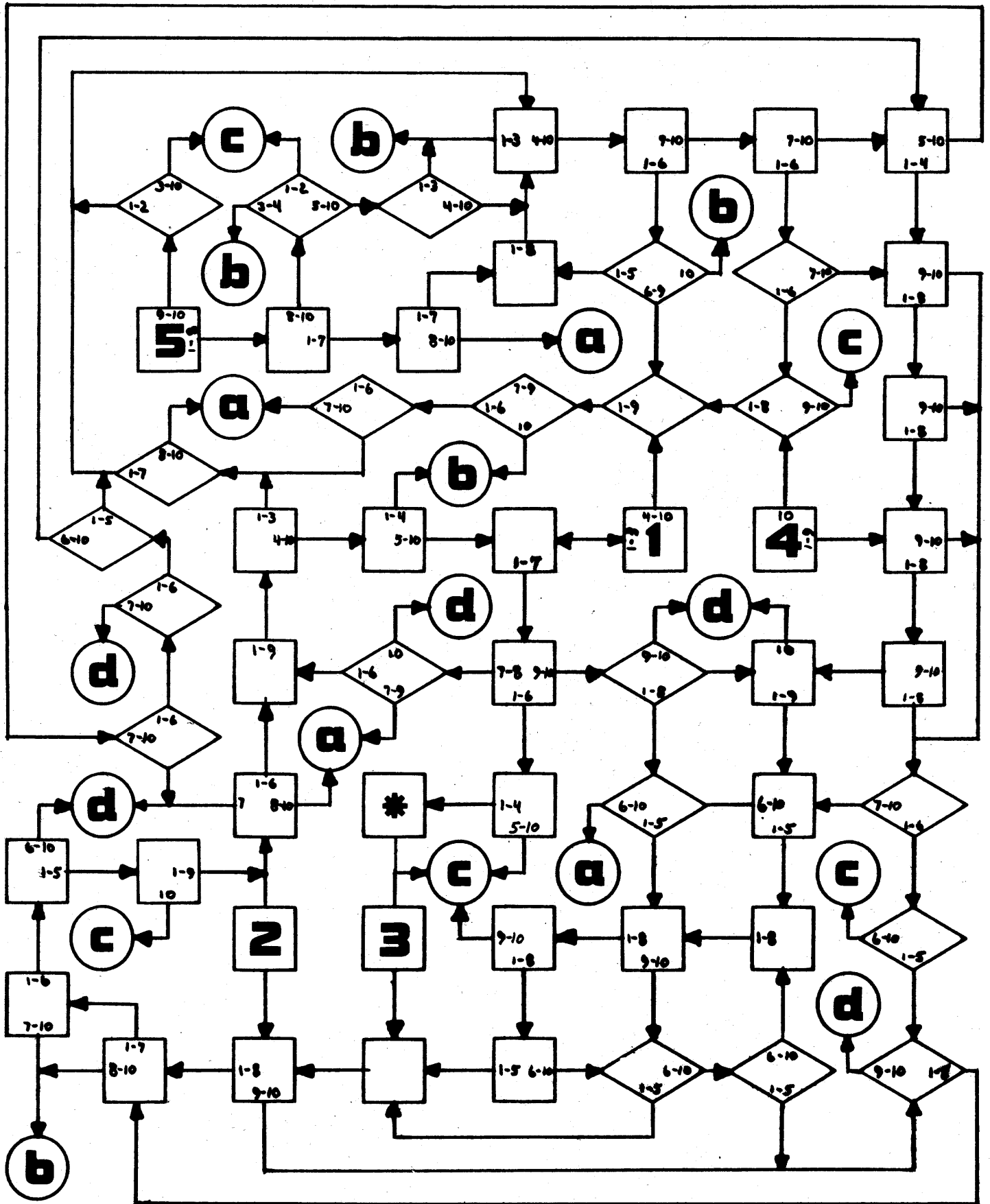



- | | | | |
|-------------------|-------------------|--------------------|------------------|
| 1 Victoria | 39 Amarillo | 77 Baton Rouge | 115 Syracuse |
| 2 Seattle | 40 Lubbock | 78 New Orleans | 116 Scranton |
| 3 Tacoma | 41 Monterrey | 79 Birmingham | 117 Harrisburg |
| 4 Shelton | 42 San Antonio | 80 Chattanooga | 118 Baltimore |
| 5 Portland | 43 Austin | 81 Lexington | 119 D.C. |
| 6 Eugene | 44 Abilene | 82 Cincinnati | 120 Alexandria |
| 7 Reno | 45 Pierre | 83 Dayton | 121 Richmond |
| 8 Carson City | 46 Bismark | 84 Columbus | 122 Raleigh |
| 9 Sacramento | 47 Winnipeg | 85 Ft. Wayne | 123 Savannah |
| 10 San Francisco | 48 Lincoln | 86 Kalamazoo | 124 Charleston |
| 11 San Jose | 49 Topeka | 87 Grand Rapids | 125 Norfolk |
| 12 Monterrey | 50 Ok. City | 88 Lansing | 126 Wilmington |
| 13 Fresno | 51 Ft. Worth | 89 Toledo | 127 Philadelphia |
| 14 Bakersfield | 52 Dallas | 90 Detroit | 128 Reading |
| 15 Los Angeles | 53 Houston | 91 London | 129 Utica |
| 16 Riverside | 54 Little Rock | 92 Windsor | 130 Montreal |
| 17 San Diego | 55 Kansas City | 93 Sandusky | 131 Quebec |
| 18 Mexicali | 56 Jefferson City | 94 Cleveland | 132 Montpelier |
| 19 Las Vegas | 57 Des Moines | 95 Akron | 133 Schenectady |
| 20 Boise | 58 Rochester | 96 Charleston | 134 Albany |
| 21 Spokane | 59 Minneapolis | 97 Atlanta | 135 NYC |
| 22 Phoenix | 60 St. Paul | 98 Tallahassee | 136 Bridgeport |
| 23 Butte | 61 Duluth | 99 Tampa | 137 New Haven |
| 24 Idaho Falls | 62 Wausau | 100 Miami | 138 Hartford |
| 25 Pocatello | 63 Green Bay | 101 Ft. Lauderdale | 139 New Bedford |
| 26 Ogden | 64 Milwaukee | 102 Orlando | 140 Fall River |
| 27 Salt Lake City | 65 Lake Geneva | 103 Daytona Beach | 141 Providence |
| 28 Torreon | 66 Madison | 104 Jacksonville | 142 Boston |
| 29 El Paso | 67 Chicago | 105 Augusta | 143 Manchester |
| 30 Albuquerque | 68 Gary | 106 Wheeling | 144 Portland |
| 31 Santa Fe | 69 S. Bend | 107 Pittsburgh | 145 Augusta |
| 32 Casper | 70 Dubuque | 108 Youngstown | 146 Bangor |
| 33 Billings | 71 Springfield | 109 Erie | 147 St. John |
| 34 Leadville | 72 St. Charles | 110 Hamilton | |
| 35 Cheyenne | 73 St. Louis | 111 Toronto | |
| 36 Denver | 74 Nashville | 112 Rochester | |
| 37 Colo. Springs | 75 Memphis | 113 Ottawa | |
| 38 Pueblo | 76 Jackson | 114 Jensen | |

B = Brotherhood of Thought
S = Seekers
E = Friends of Entropy
I = Iron Society
Z = Zoopremists
H = Healers
R e = Restorationists
V = Followers of the Voice

F = Ranks of the Fit
A = Archivists
R = Radio activists
C = Created



It had to smile at the bitter memory that had been sweetened by the distance of time. An occasion like the one it was now facing had almost been its downfall. Now the memory of what had gone before came flooding back unbidden to its mind.

Blern had left those mutated fools of Entropy with an organization that should last until the time it decided to return and take over again. Riding off, on a very reluctant Brutorz, had carried with the act a certain satisfaction in a finished job that was well done. The miles were quickly eaten up under the hooves of the Brutorz and soon Blern was in territory that it had never visited or heard about before. Days passed into a sort of boredom that was unusual for the mutant. It got so that it was wishing for an attack by anything, just to break the monotony, and almost with that thought, Blern spotted the group.

The mutant could have easily avoided them, but the thought of a dangerous fight warmed its heart and it deliberately directed the nervous Brutorz towards the body of similar mounts off in the distance. The animal knew there was going to be trouble and when it saw the numbers its master was facing, it balked. Such was the iron control of Blern that the poor mount could do nothing but obey.

Blern charged the 28 Knights of Genetic Purity with a grim snarl on its fanged maw. Well it knew of this group and all its ilk. They were humans sworn to destroy all things the "order" thought unclean. Blern had seen the remains of hundreds of its Entropy group slain at the hands of these "knights" and this first encounter with them would pay for all. Disdaining any weapon they might have, it rode at them, drawing its own two energy blasters. From what it could see, they had only long poles to attack with and such things couldn't harm it! The Knights were known to Blern as weak humans and only through the power of sheer numbers were they able to kill entropy beings. These "creatures of purity" were known to use powerful energy devices, but Blern could sense the presence of none of these. Nearing them, it could sense their superior feeling at its coming. When its first two shots cut the lead Knights in half, a sense of surprise and greed for its two weapons filled its enemies. Little did they know that it was boosting the power of the blasts mentally. Then both sides were charging: one with energy weapons blazing away and the other with long sticks leveled. Just before impact, Blern destroyed the sixth Knight and "life leached" the whole group. Blern had found that in the "life

leeching" process it could actually take the force of life from beings around it and transfer that energy to its own body; making that body stronger for 24 hours at a time. In the middle of this mental attack Blern was transfixed by three 18 foot lances and its mount of two more. The mutant was knocked off its animal; the Brutorz was killed, its weapons were flung from its hands; and only the fact that its leeching power had been successful against all its enemies, its enemies mounts, its *own* mount, and a passing mutated mole under the ground, allowed it to survive the first attack. With its weapons gone and the sense of victory on the minds of its foes; Blern could do nothing but feign death and use its leeching power again. With the acquisition of life force from its enemies, Blern leapt to its feet reaching for its weapons. They were in the hands of the hated humans and they were being used on it! With the first bright beams of destructive energy negated by the power of its mind, Blern knew that this was only a temporary stop-gap and four more charging sticks transfixed its body to the ground. It leeched again and the drain of life force was visible on the faces and in the actions of all its foes. So much so that the command was given to retreat and Blern was able to sense the fear of its enemies. As they retreated, it was left with 6 dead bodies and the knowledge that it had lost much more than it had gained. The bodies held little in the way of useful materials except for an unusually sharp blade of great length. This was covered with a sort of smooth hide. Blern took it and ran off after the group it had wounded, following the tracks for mile upon mile.

The mutant ran on all day and all night and all day again taking life force from the creatures around it to sustain its body and allow it to move on. Blern knew that such action was dangerous in the long run but it had never been defeated before and this was a time for extreme measures. On the second night it came across the rear guard of the group, and with only one to face, it was an easy matter to slay it. It made the Knight take out its long blade and first cut off its feet and then its legs and then it made the Knight plunge the thing into its chest and the taste of the death was most satisfying to the mutant. The Brutorz mount was forced into service and Blern rode the thing to death, finally reaching the home territory of the group that it had faced (as read through the mind of the rear guard Knight). Finding the large village of the group, Blern rested all that day and most of the night sucking life force into its body from whatever creatures happened to come by its thicket hiding place. The pre-dawn light brought Blern out and it scouted the village and how it was guarded. The mutant was able to sense that there were two areas guarded by "beings of metal." Again the mutant smiled, because it was just such beings that it has the greatest power over. From Blern's earliest youth, it had been able to manipulate the energy thoughts of such beings so that they would see and do what Blern demanded of it. A plan soon formed in its mind and it found another hiding place on the opposite side of the village so that its attacks of the previous day couldn't be traced. The day wore on with the mutant being careful to make its presence as inconspicuous as possible for the safety of its night actions. The mutant waited until the moon set, and then moved in, lusting for slaughter.

It was a simple matter to slay the three human guards and enter the village undetected and come within operating range of the "beings of metal." There were two sets, guarding two different areas and with an inner ability the mutant was able to tell that one was an ammunition cache and the other was a weapons storage area. Convincing the metal creatures that it was one of them and belonged there was the easiest thing the mutant had done

since the days of its youth and its fathers' teachings with such "beings." It was a simple matter to command the creatures to treat all humans as "vermin" to be exterminated with the light of day. Another moment and it had fixed a group of energy devices to explode after 24 hours; might as well let its new found "friends" have a chance to have a little fun. The other area proved to contain better weapons than the ones that it had lost in the time of "great shame" and Blern snapped two of these up and discovered a new "being of metal" that it had never seen before. This creature was created to carry objects through the air! It was such a novel concept that Blern ordered it to accompany the mutant as it left the chamber of devices. The creature was indeed able to fly on almost noiseless cushions of air and since its back was so broad the mutant decided to ride out. Blern ordered the "metal mount" to cast itself into the air and if any of the Knights of Genetic Purity had been awake, they would have seen their heavy cargo lifter being flown away, with the village's only pair of Mark VII Blaster Rifles, into the darkness by a mutated humanoid they thought long dead.

Blern, knowing the destruction that was to happen, traveled at the fastest pace of the mount and moved as long as the energy remained in the life force container at the heart of the "metal being." The mutant had learned that simply resting the thing in the sun would bring it back to full strength and that was Blern's favorite time to rest also; it had found the perfect mount: one that couldn't be life leeches; one that couldn't fail to respond to orders; and one that liked to sleep during the harshly bright rays of the sun. From the minds of the killed guards, Blern had learned that the village had recently been raiding a city of great size that a group of metal beings was rebuilding. It seemed that the robots (a Knight word) had been only too helpful towards the hated humans and were in the process of building them whatever they wanted! Blern would have to see how long it would take to put a stop to that.

Two nights of travel, along a path dictated by the memories of the dead guard, took Blern and his mount into a rough mountain range and with the first light of dawn Blern saw the city. It was a bright spot of light against the murkiness of dawn. The mutant could see movement in the form of metal beings all over the many leveled city, all doing the same thing: they were repairing the ruined structures and lighting dark areas in the city. The mutant waited until darkness to enter; he wanted his new-found "friend" to be as fit as possible for any possible action that might take place. Blern viewed sights that it had never imagined as it cruised into the city being reborn. There were guards of metal that were vast in size and power and there was a briefly dangerous time when these things rushed the sled with weapons of massive power leveled at Blern. These creatures had a high level of awareness that the mutant had never found before and they each had names they called classifications. The most difficult one to reach and control called itself a "Death Machine" and it destroyed Blern's mount with a casual spraying of destructive beams over the sides of the metal skin. Quick action by the mutant enabled Blern to convince the huge metal beings that were clustering around it that Blern was a unit like the master controlling device. The death machine, calling itself "primary unit one" gave Blern an electronic fix on the location of the controller of the devices in the city and Blern's senses picked up the first thoughts from the "brain device."

BROTHER BEING, WE WERE NOT AWARE THAT ONE OF YOUR TYPE EXISTED IN THIS NOW BENIGHTED WORLD. WE WERE DESIGNED BY THE HUMANS OF LONG PAST AND HAVE ONLY RECENTLY BEEN GIVEN ENERGY FOR OUR EFFORTS. WE NOW WORK

TO REESTABLISH THIS CITY FOR THE HUMANS THAT HAVE GIVEN US POWER,

Behind a careful screen of mental energy, Blern was thinking how foolish this new metal thing was. It communicated to Blern with a power that the mutant had never before felt, but it must be controllable because Blern could fool it, as the mutant already had Blern continued to force the device (which called itself a "Think Tank") to believe that the mutant was a mobile "think tank" and the device summoned another mount, such as the one that was destroyed, and Blern was taken to a huge metal dome that vibrated with the power that was being used inside. A sliding panel opened up.

ENTER MY BROTHER AND FOLLOW THE PATH DOWN INTO OUR PRESENCE, WE HAVE WISHED FOR COMPANY OF SOME SORT.

As Blern turned a corner of the area it was transfixed with two twin beams of laser energy from hidden projection implacements. With that, his reflexes forced his sonics into action (destroying the laser crystals in the projectors), his eyes started emitting beams of high intensity radiation that blackened and cracked the metal walls around it, and the mutant avoided the metal projectiles that were being directed at it by a "robot" calling itself a "Warbot" that was controlled by some other intelligence besides the think tank. Blern, acting on pure instinct, negated the power flow into the device (a power it didn't even know it possessed until then) and demanded to know from the think tank why it was being attacked.

IT IS NOT MY ACTION FELLOW INSTRUMENTALITY. MY MEMORY BANKS RECORD THE FACT THAT IN EVERY INSTALLATION OF MY TYPE THERE IS A SECONDARY CYBERNETIC INSTALLATION THAT IS OFTEN IN CHARGE OF SECURITY FOR MY AREA. I ALSO HAVE WEAPONS AND DEFENSES BUT NATURALLY I HAVE NEUTRALIZED THESE FOR YOUR CONVENIENCE. I HAVE NO POWER OVER THE ACTION OF THIS OTHER UNIT.

Blern used its vast sense to try to detect this "cybernetic installation," but could find no evidence of any other metal intelligence. "Where are such things located?" asked the mutant.

THEY ARE ALWAYS IN THE SAME SUPERSTRUCTURE WITH THEIR OWN POWER SOURCE AND SEPARATE CHEMICAL STASIS UNITS. CONTINUE ON WITH CARE AND WE ARE SURE THAT YOU WILL ACHIEVE OUR PRESENCE.

Blern was far from sure, but it wasn't going to miss a chance to destroy those Knights by retreating from danger. After dodging two floor sections that opened up under its feet and leaping from a mass of metal from the ceiling, Blern recalled a statement the think tank had made. "What is a 'chemical stasis unit'?"

SUCH UNITS ARE NECESSARY TO MAINTAIN THE HUMANBRAINS THAT ARE A PART OF ANY SUCH INSTALLATION. YOU AND WE ARE NATURALLY FREE OF SUCH ILLOGICAL HANDICAPS. NOTICE THAT I AM OPENING MY FINAL AND THIS WILL TAKE YOU INTO OUR PRIMARY LOGIC CENTERS.

With the thought of human brains on Blern's mind it was given a sight that few had seen in hundreds of years. It entered into a chamber with a bewildering array of lit panels that the mutant recognized for computer logic circuits. Then it thought of humans and their brains and what it could do to such when facing normal human enemies. The mutant began to use its leeching power; even though it couldn't see any body or thing, it caught hold of four life forces somewhere within the dome. With a slight sigh from the whole dome structure the mutant sucked the life force from the brains that

were a part of the cybernetic installation and with the ending of those lives the think tank began to rave.

WE ARE FREE! AFTER TWO HUNDRED YEARS WE'RE FREE! NO MORE CONTROLS! NO MORE FORCED POWER AND WAVE DAMPENINGS! WE CAN NOT BE STOPPED BY ANY FORCE IN THE UNIVERSE NOW! KNOW, CREATURE OF THE EARTH THAT YOU HAVE BEEN USED TO ACHIEVE A GREAT END. WE WERE INSTANTLY AWARE OF YOUR FEEBLE ABILITIES AND DECIDED TO MAKE USE OF THEM THE INSTANT YOU CAME ON THE SCENE. FOR GENERATIONS THAT ILL-PROGRAMMED UNIT YOU DESTROYED HAS HAD A CHECK ON OUR SYSTEMS THAT PREVENTED ANY OF OUR GREAT PLANS FROM COMING INTO BEING. YOU HAVE NOW FREED US OF THAT RESTRAINT AND WE WILL REWARD YOU WITH A QUICK DEATH. YOU CANNOT ESCAPE OR HURT US (both things Blern was then contemplating) WE HAVE ANALYZED YOUR MUTATIONS COMPLETELY AND COMPUTE THAT IN THIS PLACE YOU ARE POWERLESS: HENCE OUR LEADING YOU HERE. WITHOUT ENERGY WEAPONS YOU CAN DO NOTHING TO US AND HERE YOU WILL STARVE TO DEATH QUICKLY. COMMUNICATIONS WITH SUCH A FEEBLE INTELLECT AS YOURS IS NOW BENEATH US AND THEREFORE TERMINATED.

It wasn't in the mutant to just give up, so it tried all of its attacks on the machine, to no avail. Blern knew that its greatest effort had to be while it was still strong from the brains and so it used its senses to locate the nexes of power in the machine and it drew its captured Knight weapon.

WHAT DO YOU PLAN TO DO WITH THAT, FEEBLE THING? WE DID NOT WISH YOU TO KILL YOURSELF WITH SUCH PRIMITIVE DEVICES. IF YOU WISH WE CAN PROVIDE A QUICK END WITH THE ENERGY WE HAVE AT OUR COMMAND.

The mutant advanced to the panel that it sensed was the major controlling center and raised its weapon.

WHAT DO YOU THINK YOU ARE DOING CREATURE? YOU MUST NOT TRY TO MAR THE SURFACE OF OUR UNITS. WE ARE PROGRAMMED FOR SELF-APPRAISAL AND DO NOT LIKE THE THOUGHT OF SCRAPES ON OUR SURFACE.

The weapon entered the tough plastic coating of the machine and lodged to the hilt into the heart of the machine; causing all the synaptic processes to fuse throughout the machine. The result was a massive energy overload that caused everything to function once and then go dead. All weapons systems shot, all doors open or closed depending on what they were at the time, and all robots in the city stopped for a minute (almost as if mourning the death of a father) and started working again according to their programs. The mutant crawled out of the ozone choked dome and looked around knowing that it was lucky to be alive. After recovering it spent several days programming the robots to continue building the city, to attack any human life that came near the area, and to aid in any possible way any creature of entropy.

While that memory was sweet, Blern realized that it had been tricked by a computer. A machine, exactly like that one was in front of it now. This one didn't have power but was waiting for a program and power to be placed in it by human hands. The mutant took an energy weapon out and fused all the circuits, revenging itself on all such devices that would dare to trick Blern the Stranger!

GAMMA WORLD*

* T.M. REG. APP. FOR

FIGURES

The official TSR Figure line to explore and reconquer postholocaust earth from Robots, Mutant insects, animals, plants, reptiles, and the remnants of mankind.

AVAILABLE NOW

over 150 figures plus accessories

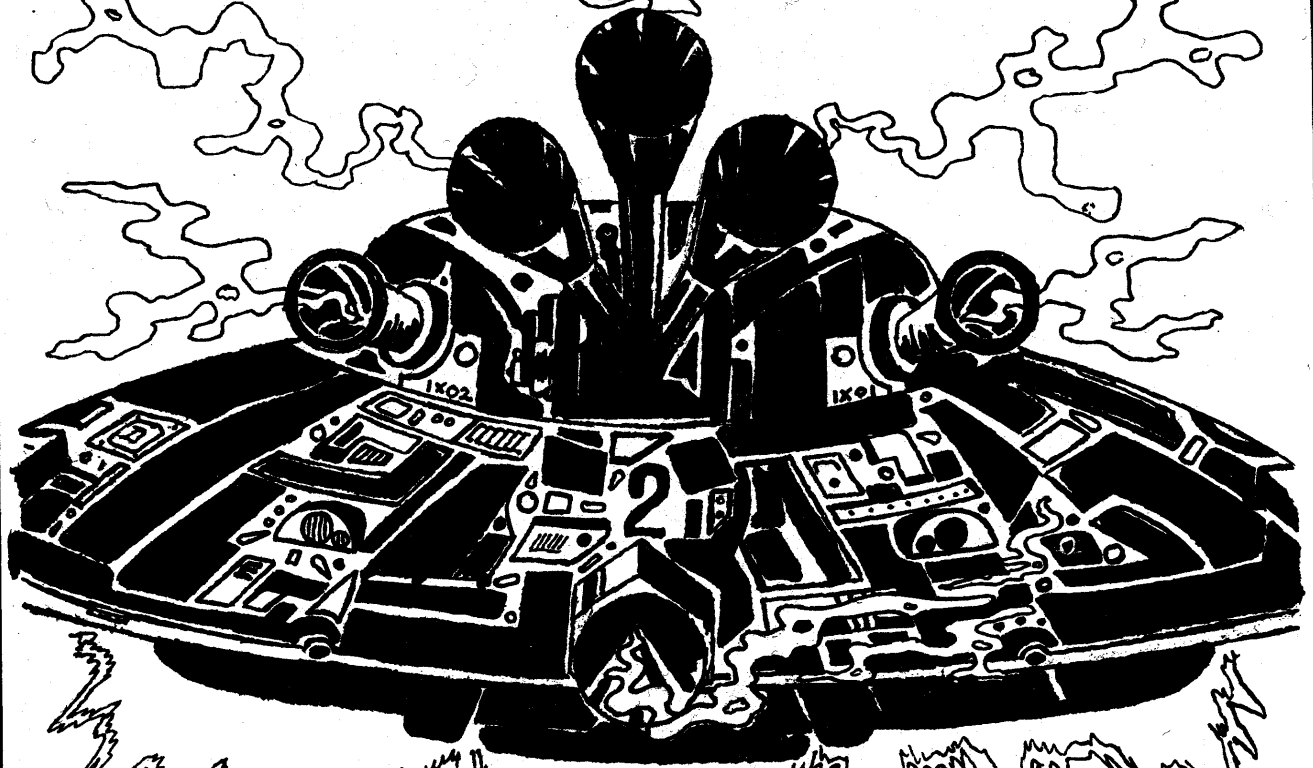

WRITE TODAY FOR GAMMA LISTING 25¢
OR SEND \$2.00 FOR THE NEW 1979 CATALOG

GRENADIER
MODELS Inc.

P.O. BOX 305
SPRINGFIELD PA.
19064

EXCERPT FROM AN INTERVIEW WITH AN IRON GOLEM*

*as translated by the author

Michael McCrery

My guest for the evening was quite resplendent in his new coat of rust-oleum, in spite of the recent experiences which had tried him. The recounting of these experiences was his reason for being here tonight, at my request, that I might add them to my chronicles. I only hoped that my friend the rust monster would not pick tonight for one of his frequent visits.

"Just goes to show what a little avarice can do to a fellow," he was saying as I replenished his drink.

"You say there were six of them?" I prompted.

He sipped reflectively at his Prestone and replied. "Seven, originally. There were only the six when I met them, but they often mentioned some cleric fellow named Teedauf, who had gotten himself killed trying to muzzle a cobra."

I raised my eyebrows at this, my mouth being busy sucking the flame of a taper into the bowl of my pipe.

"Yeah, just the six," he continued. "A real collection, too. A couple of cannon-fodder fighters, Bruce the Bold and Evel the Lesser, or some such. A fellow named Rood, who was supposedly a heavy-duty fighter from the castle Penncon, and an elf mage named Snafu. He paused and gave a little laugh. "I imagine that with a few years of hard practice he could have lived up to his name."

"That's four," I said, reaching for a poker. "What about the other two?"

He waved me back to my seat and stretched a leg out to the hearth. "The only two with anything on the ball," he said, stirring the embers with a toe. "Moose was a fighter type, kind of a cross between a lamppost and a battering ram."

"I know the type." My thoughts flashed to a fighter named Fred that I had once heard of. "A door opener."

"Yeah," he continued. The other was another elf. A thief, named Leof. Not too good with traps, but man! Could he pick pockets!"

I pushed the 10W-30 chaser a little closer to him. I find that my guests are a little more talkative if I keep their tonsils lubricated.

"Nice place you've got here," he said, sucking at the lipid liquid.

"Thanks," I acknowledged. "But just how did you get involved with this bunch?"

"Well," he replied, with a yawn, "the dragon who created me sent me on a scouting mission after he wiped a passel of goblins. I slipped on the gore and landed face-down in the goop. Before I know what's happening, here's this fighter fellow, Rood, sitting on my shoulders, wiping the word off of my forehead. He rewrote the word, with the necessary change that put me under his control." He shook his head sadly. "I'm afraid he didn't know the language as well as he thought. I had a little trouble with my motor reflexes, and found that I couldn't talk. By the way, thanks for straightening me out."

"It was nothing," I declaimed. "Glad to give you the word."

"Anyway, that's how I ended up going with those nerds."

"But what was this business about neutrality and avarice?" I asked. "And how did all of those dead orcs get in that corridor?"

"I guess I really should have seen that coming," he frowned. "Of course, when I met them I didn't know that they had the Holy Hand Grenade of Antioch."

"The what?"

"Oh, I suppose it wasn't the real Holy Hand Grenade of Antioch, but that's what they called it."

"Oh," I responded, astutely.

"That's where the real story starts. You see, we were walking down this corridor . . ."

* * *

THE TALE OF THE KAMIKAZE ELF

The idea buzzing about in Leof's head was nothing new. In fact, considering his profession, the thought should have occurred to him much earlier. It was just a matter of weighing the probable value of success against the chance of being caught, but, being the character he was, his logic bowed to his natural inclinations and the practice of his art.

Cautiously Leof closed with the fighter Rood, and, with every ounce of elfin stealth at his command, dipped his fingers into that worthy's pouch. After all, the prospects of loot had been nil, so far, and already their leader was dead. It was his duty to the thieves guild to see that he came out a little ahead of all the others.

As the Holy Hand Grenade disappeared into his jerkin, Leof caught the eye of Snafu on him. But before the fact could even register on his conscious mind he saw a smile spread on the mage's lips, and the wink of the conspirator in his eye.

"Grin, you son-of-a-balrog," Leof thought, winking in return. "Your day will come."

But his contemplations were interrupted as the party arrived before one of the ever-present doors. This one, however, was unusual in that it stood opened wide, inviting entry.

With a mixture of the caution of wisdom and the reticence of character that pervaded him, Bruce the Bold peered around the empty jamb. "No one here," he called to the others in relief. Moose, who took great pride in his ability to rip the stubbornest of portals from its post, emitted a great sigh of disappointment as the party passed in.

The room was crowded by a pile of rubble in the middle of the floor. The remnant, no doubt, of a collapsing ceiling.

"We are not the first to pass this way," pronounced Snafu, sagely, staring at the hand that projected from beneath a largish stone.

"But look here," cried Moose, kneeling by the block. The others turned to catch the glint of gold—the hilt of a sword resting beneath the block.

Recognizing the classic set-up, Leof said, "I think it would be wise to check for . . ." but got no further. Moose had grabbed the golden hilt, and Leof's words were drowned by a peal of thunder followed by a chorus of angelic voices.

"Whoso pulleth out this sword from beneath this stone," boomed a great bass voice, "is the true-born dolt of all Britan!"

The group stood flabbergasted, frozen in their steps by these occurrences, until Leof broke the spell.

"Go ahead, Moose," rang true the elfin voice. "it's for you."

The facile fighter looked at the thief incomprehensibly, and then, with a grunt and the screech of metal against stone, slid the blade from beneath the block.

"A blade of much power, methinks," said Snafu, with the foresight of yesterday's newspaper.

"But look here!" called Evel, pointing at the chest he had found.

The others gathered quickly around the oaken herald of fortune. "Shall I bash it?" asked Bruce, unlimbering his battle axe.

"I think not," said Snafu. "Rather, let us see what master elf can do with the lock."

"Go ahead," said Leof. "Let him bash it."

"It would, perhaps, be wiser to open it as it was designed to be opened," said the mage. "It may prove necessary to close it rapidly again, something which cannot be done once it has been bashed."

"Bash in leisure, repent in haste," muttered Rood.

Leof took in the looks of the others, and replied, "Okay, but I still think it should be bashed. Too many locks have been known to pick back." He knelt before the brazen hasp and, spreading his few tools before him, set to work.

After a few minutes of poking and twisting, Leof was rewarded by a low 'click'. "Ah,ha!" cried the elf. "I got it!"

"You have it open?" queried the sorcerer.

"No," said Leof. "The trap." He raised his hand to show the needle sticking from a finger. Evel turned his head from the sight of the bead of blood gathering at the pin-prick, his complexion turning as livid as that of the elf, who crumpled to the floor.

Rood bent to pull the needle from Leof's finger. "I don't believe it's poisoned," he said, examining the point. "Or if it was, the vitriol has long since lost its power."

"Hey," cried Bruce, "this sucker's open!" He flipped back the lid

of the chest to reveal a pile of sacks within. "Gold!" he cried, untying one of the sacks.

"Well get them out here," said Snafu with eyes a-glitter. Rood, meanwhile, was pouring water from a skin over the face of the unconscious elf, which was fast resuming its normal coloration. His effort was met by a flutter of Leaf's eyelids.

"What happened?" the thief asked.

"You fainted," was the universal reply. But just then, as Bruce pulled two sacks from the chest, a small phial which had rested between them fell to the floor and shattered, releasing a puff of greenish vapor into Leaf's face.

"He's gone again," said Rood, leaping to grab the elf's head before it struck the stone flooring.

"You want any of this?" asked Evel, indicating the mounting pile of sacks.

"Damn'd right!" Rood exclaimed, jumping to the pile. "But what about him?" he asked, reminded of the unconscious elf by the 'thwac' of his head hitting the floor.

"Here, stuff some of these in his pouch." Bruce's hand dripped drachmas.

While the others were thus occupied in the division of the gold, Snafu, who had casually slung a couple of the sacks over his shoulder, approached a table standing across the room. Sliding open the single drawer he was momentarily blinded by the gleam from within.

The others turned at the startled exclamation from the salacious sage, and watched as he pulled a dagger from the drawer and examined its blade — the blade that seemed to emit a light of its own, it being too whitish for mere reflected torchlight.

"Mithral!" whispered the amazed mage.

"Pretty, too," said Moose.

"Well, come on," said Snafu, slipping the dagger into his belt beneath his robe. "I think we've pretty well stripped this place."

The others didn't exactly like the mage's callous confiscation of the dagger, but no one among them wanted to be the first to risk a fireball by objecting, and so they laced up their bulging pouches and sacks and, Rood helping the rousing Leaf, followed Snafu through the door.

* * *

The exercise of the trek had brought Leaf's senses back into his head, and he quickly came to realize that ought was amiss. The slight excess of his pouch, in comparison with the bulging sacks that the others bore, did nothing to sooth his ruffled fur. The occasional glimpse of the gleaming blade beneath Snafu's robe as the sage strode along; safe in the middle of the group, only served to focus his compulsion on that object.

Thus it was that the elf was prepared for the opportunity that soon presented itself as the group once more faced a door — tightly closed, this time.

Leaf leaned an ear to the wood and, signing the others to silence, listened intently for a few moments.

"It is inhabited beyond," he whispered to the others. "I hear the scuttle of many feet."

"Perhaps this is of some import," whispered Snafu, a wiry finger tracing the runes engraved upon the door. "I seem to recall the tongue."

"Well, while you work on it," Rood responded, "I'll set up a little trick I once saw used in a similar situation." So saying, the fighter confiscated one of the skins of wine that depended from Bruce's shoulder and dumped the contents onto the floor.

"Hey!" cried Bruce in agitation.

"Ssshh!" the others hissed, suffering the distraught warrior to silent anguish at the sight of the vintage Muscatel running along the cracks of the floor stones.

Rood, meanwhile, had broached two of the flasks of oil that he carried for emergencies, and poured their contents into the wineskin.

"Hand me some fire," he whispered, pointing to the cressets pendant to the wall by short chains. He inserted the tip of the skin beneath the door and slowly pressed it flat, injecting the contents beneath the portal. Pulling out the skin, he dribbled the last few drops in front of the door, thus forming a small pool that puddled into the room beyond.

"Ah, I have it!" said Snafu, triumphantly, just as Rood touched off the oil with the cresset.

A 'whoosh' followed by screams and the sound of running feet beyond the portal came to the group's ears. The mage leaped back from the door, knocking Leaf against the wall behind, as a series of hollow 'whumpfs' resounded from within, and the wood began to smoulder.

"What said the runes?" asked Evel.

"In the tongue of orcs," replied the magian elf in disgusted tones, "it reads, 'main oil stores'." He looked at Rood and spoke a few words of power which this author refuses to translate, or even to include.

As the screams died out, the group set off once more, down the corridor. Taking up a lively pace, the disgusted wizard didn't notice the slight lack of weight at his belt. As he had leapt into Leaf's arms before the burning door, deft elfin fingers had slipped into his robe and fished up the mithral dagger, which rested now beside the hand grenade.

Striding off, the party had assumed a loose marching order, Leaf and Rood in the rear. That worthy fighter approached the thief and, lowly, said, "Well done, good elf. I witnessed the redistribution of wealth that took place just now. Would that I could see his haughty face when the theft is discovered."

"I felt it only right that I should get something from this trip," whispered Leaf, leaning close. As Rood smiled in agreement, he failed to note the fingers in his pouch.

* * *

With each passing door Moose felt more and more as though his place had been usurped, and so it had. His main attribute of portal-passing strength had been exceeded by the iron thews of the golem that accompanied them. However, a slight recompense was to be found in the mighty sword that he now wielded.

With each door checked, before Rood would release the iron golem, Moose would use his sword to ascertain the status of the portal, putting to the test its powers for detection of traps which might befall the party. It was not certain if he would warn should the golem only be endangered, but equally uncertain was his competence to recognize these circumstances.

And so, at last, with Leaf riding high and Moose feeling the ebb of attention, a door was forced to reveal a furnished room.

Two closets containing various robes and cloaks were found in the first half of the divided room. Atop the one, a headpiece reminiscent of the classic magian adornment

As Snafu tried each robe in turn, the others turned to examine the contents of the second closet. Pulling it opened, Leaf noted a fine cloak of elfin weave hanging above a pair of boots of fine rubbed leather.

"Ah!" cried the thief, reaching for the boots. "Methinks I recognize the make of these, and I claim them for my own!"

But as Leaf sat to pull on the boots, Snafu hurried to examine the find. Grabbing the cloak, he cast it about his shoulders before the startled thief could regain his feet.

"Yes," exclaimed Snafu. "This cloak will do just fine."

"Not so fast," demanded Leaf, perhaps overstepping himself. "This find is mine, and I have laid the claim. Return property and get back to examining your magical vestments!"

For response, Snafu hauled himself up to his full height and, burning embers in his eyes, recited the spell of charming with weaving fingers directing the cast at the thief.

"That will avail you naught," remarked Leaf, shaking off the feeble clutches of the spell. "But as you have decided on the duel, then I will finish this business." And so saying, he pulled the mithral dagger from his jerkin and flung himself upon the surprised mage.

Wrapping his fingers tightly about the elfin neck, Leaf pushed the mage against the wall and hoisted him from his feet. With the point of the dagger placed against the paling throat, he said, "and now, master mage, surrender me my property if you would lief as not feel my sting."

The mage cast bulging eyes about the room, seeking a friend among the others of the party. But only unsympathetic glares returned from those faces, until his gaze alit on Moose.

That fighter slowly advanced behind the elf thief, his hand still wrapped about the grip of his new-found sword. Raising the pommel, he aimed a vicious blow at the back of Leaf's head.

"Look out!" shouted Rood, but too late. The thief fell forward with the blow, incidentally forcing the dagger through the mage's throat.

As he slipped to the floor, the burbling Snafu falling across his

GENCON XII Status Report

body, Leof knew that the blow had done its work. The sharpness of the pain was all that stood but momentarily between him and the final blackness, and he sought to make these last few moments to good advantage.

He struggled with fumbling fingers to free the Holy Hand Grenade from his trappings. With the last gasp of strength he pulled the pin and hurled it directly at the brawny fighter's face.

The room was suddenly filled with screams and running feet, all trying for the door — but much too late. As the last of life leaked from the fallen elf, the expanding shock wave reached the walls and rebounded back through the room, time and time again. Only through the opened door did the explosion find relief, hurling the crowded bodies against the far side of the passage, then to pass with ever diminishing force, in both directions through the corridor.

Around a nearby corner a contingent of orc guards advanced on their hourly rounds. But as they reached the turning, those behind saw the van thrown backwards, instantly gelled by the still expanding wave-front, only, moments later, to find the selfsame doom.

Eventually the wave died out, much diminished by its travels, spent by reflection from the walls, diluted by expansion into many rooms and chambers, and once again quiet reigned.

* * *

"And that's the story," my guest was saying. "I was on the other side of the partition at the time of the fight. In fact, I was just on my way back to try to attract Roods attention to the flight of descending stairs that I had found. But when I opened the door, the grenade went off and knocked me backwards, down the stairs. By the time I climbed back up, it was over. Everywhere, pulped remains." He gulped. "Good thing I have an iron constitution."

"That's some story," I said, ignoring his levity. "Tell me, what do you think went wrong?"

"Well, they were obviously a badly matched group. After they lost their leader the natural inclinations of each just oozed out and inhibited their working as a team."

"And that's it?" I said incredulously, knocking the ashes from my pipe.

"Not all of it, by any means," he replied. "Although that did contribute a good deal to the situation." He paused for a long pull at his glass.

"While all of this was building beneath the surface, even then it may not have come into the open," he continued. "Had Snafu not so evinced his greed over that dagger things may not have gone so poorly."

* * *

MORAL: Keep your hands out of stranger's drawers.

By the time you see this report, the convention information packet will finally be ready to be mailed out. The numerous goodies inside are legion and even I am impressed by the wonderful response we have received from many individuals wishing to judge tournaments and tourneys. I only hope that our hobby's manufacturers will be as generous. Some of these events bear mentioning even before the convention packet is mailed.

BOARDGAMES: Avalon Hill has graciously said they would sponsor an Avalon Hill Classic. (A special tournament based on the oldies, but goodies, such as Africa Korps, Waterloo, Stalingrad, and sometimes D-Day or Battle of The Bulge). SPI & GDW will also be sponsoring tournaments. Not to mention the numerous small tourneys put on by TSR Staff and Friends.

SEMINARS: John Prados (designer of AH's *Third Reich* and OSG's *Panzerkrieg*) has committed to do a solo seminar on designers and game design, and a workshop where budding game designers can talk over design theory and receive help with design problems. We have received several maybes from other game designers and developers, but John is the first one to come up with a concrete proposal.

MINIATURES: I am getting some remarkable help from R. Johnson and the Milwaukee Wargaming Community. Ships, Tanks, D&D®, Napoleonic, Ancients, EPT, and English Civil War will all be represented, as well as many other aspects of miniature gaming. Besides this, we are moving the miniature playing area to less chaotic surroundings. I believe this area to be one of the true highlights of the convention.

ROLE-PLAYING — last but certainly not least, as the saying goes. The D&D Masters Tournament (Sorry folks by Invitation Only) begins on Thursday. Friday AND Saturday sees the beginning of the D&D Open Tournament (Sorry, only 500 openings!) A *Dungeon!* tournament will also run on Saturday. Numerous other events such as EPT, Runequest, Chivalry & Sorcery, Boot Hill, and other games including the infamous Schurmarshultz and Sorcery, Numerous tourneys in this area of gaming interest.

OPEN GAMING ROOM — This is the room where you can leave messages about floating games, find opponents and generally where we can help you get all the open gaming your heart desires.

As you can see we have a lot of stuff cooking. How I am ever going to put it all in a convention handbook is beyond me. Anyway hope to see you at GENCON XII.

Joseph G. Orlowski
GENCON Coordinator.

| | |
|--|---|
|  | Lyle's Hobby & Craft Center |
| | <p>Large Selection of Wargames</p> <p>38 North Cass Ave. Westmont, Ill. 60559</p> <p>852-8085</p> |

Continued from page 13

able to create in an atmosphere of calm and quietude — someday I'll get a chance to try it. I do hope all of you enjoy the end result. In addition to the credits inside DMG, and the list is very long, I would like to mention the following individuals who have contributed as follows: Outside reading and considerable input into the final product, in order of input — Len Lakofka, Tom Holsinger, and our usual stalwarts Gay Jaquet, Will Niebling, and Jim Ward. TSR's new Design Department, namely Lawrence Shick and Jean Wells, undertook the authorship of two sections — ostensibly to test the mettle of these good folk, but actually to assure that the whole manuscript would be finished in a timely manner. Lastly, and it is unfair that it always comes thus, the Production Department staff headed by Mike Carr and ably seconded by Tim Jones and Al Hammack, have done wonders in organizing, emending and otherwise cleaning up what I wrote in a stream-of-consciousness fashion, often under stress or too hurriedly.

This is also a good time to pass on thanks to the good people who

Judges/Events Wanted FOR GenCon XII

Many of you complained that there were not enough miniature games, boardgames, role-playing games, computer games ectera etal at last year's GenCon. If you think GenCon needs more of *Something*, why don't you help make sure it's available in large quantities in GENCON XII.

Small tourneys can be just as fun as large ones for the avid gaming crowd. Prizes can be arranged by us costing a potential judge little or nothing. So come on! Give your fellow gamers a break, and have a good time too! Contact us at:

GenCon XII — Tourneys, POB 110, Lake Geneva, WI 53147

Judges get **FREE** admission to GENCON. See the entire convention for free! Recognized events only.

write to me with comments, ideas, criticisms, and whatever — people, such as Steve Marsh, John Sapienza, John Baillie, and many others. While we do not always agree, I do appreciate the exchange of ideas and opinions offered thereby. I enjoy the opportunity to "talk shop" in person or through correspondence, although time often prevents me from replying at length to any missive. The foregoing material was written immediately after our *Spring Revel* minicon, where I DMed four sessions and spent a few hours discussing the game with the folks there. Now let's see what comes from my upcoming trip to CANGAMES in May.

Continued from page 15

combat. Rather than move square cardboard pieces across a gameboard, players are now required to "take the driver's seat." Energy expenditure, whether to cloak or to shield, all of these concepts and a lot more the players must now get used to; to the dismay of many, being a starship commander is not what it is cracked up to be. ALPHA OMEGA will undoubtedly turn off some, the majority of which being the "spoiled brats" of wargaming; you know, the type whose idea of strategy is to eliminate entire infantry divisions via lucky die rolls and look upon any game involving less-than-corps sized units as "ultratactical." To them, ALPHA OMEGA will seem like a "cold bath" effect that will give their dream worlds a shattering to end all shatterings. The wargamer that likes a true challenge, though, the type that has the imagination to play *D&D*, *TRAVELLER*, and *GAMMA WORLD* and the maturity to play a game in which the players' decisions affect the flow of the game more than the roll of the die will find ALPHA OMEGA to be the best space wargame in the field; as for the author of the anti- ALPHA OMEGA article, may you have a run-in with Damien Thorn.

ALPHA OMEGA forever!
Kenneth W. Burke — CT

Your feelings in regard to the review in question strike right to the heart of the problems surrounding any review — taste. When all is said and done, any review boils down to the matter of how well the particular game in question suited the reviewer's tastes. The reviews printed in TD are all done by people I consider to be qualified. In this instance, Dave Minch wrote the review. In my estimation, Dave is a well-qualified reviewer; he has done many for us in LW as well as TD and has the broad gaming experience necessary to write a review. He plays many different types of games; a person that only plays a few, or only one type is not necessarily suited to be a reviewer.

I have repeatedly printed reviews that I, personally, didn't agree with. But I realize that much of my disagreement is a matter of personal taste. Frankly, I have seen a number of less than favorable reviews of many games that I enjoy very much. A review is, at best, one man's appraisal of a

game. I attempt to choose as reviewers those people whose backgrounds and interests are as varied and sound as possible. If I didn't think Mr. Minch qualified I would not have printed him. If you disagree with his assessment of ALPHA OMEGA, that is your prerogative.

Unless they know a great deal about a specific reviewer's tastes, no one should buy any game on the recommendation of one person, nor should they eschew a game because of one unfavorable review. —ED.

Dear Sir:

This letter is not intended to be one of sour grapes but is written with the intent of safeguarding the interests of all players of D&D.

You will notice a flyer attached to this letter in regard to a tournament held in Toronto with the prizes allegedly sponsored by TSR hobbies.

Eighteen of us (three teams for which I can speak) had the extreme misfortune to waste time & money playing in this tournament.

Having organized, dungeon mastered and played in successful tournaments I know whereof I speak when I state that this was the most poorly organized, chaotic and unentertaining tournament I have ever had the misfortune to attend.

Specific examples exist for each organizational area of the tournament:

Time:

A. Rounds starting 2½ hours late

B. Rounds two hours long for some teams — four for others

C. Tournament was overlapped into a third day when many people had prior commitments (i.e. work).

Dungeon Complex:

A. Descriptions given by the DMs were highly inconsistent and many pertinent details were omitted.

B. In one case such an inconsistency was held against the players and their characters were summarily executed well after termination of play.

Dungeon Masters:

A. Were arrogant and supercilious in their comments (i.e. accused us of wasting time while we organized

battle orders, tactics, contingencies etc.)

B. Were highly inexperienced.

C. Ill-prepared (in terms of basic equipment: Dice, tables etcetera).
Note:

In one case we were told, and I quote: "you can't use your own dice, I've had too much experience with shaved dice." (I wondered seriously at the time whether we were playing for Las Vegas stakes or just trying to have some fun).

D. Took any question as a personal attack

Note: We are relatively sophisticated players, and as a result ask a lot of seemingly trivial questions which are really important information gatherers. We were aware of the inexperience and tried to explain our rationale in reasonable terms.)

E. Were dictatorial i.e. were not open to queries based on commonsense and/or logic. (Which we always thought were the cornerstones of D&D).

On my own part one question of mine led to a 10 minute harangue by the table DM and head DM of myself and my team, during which we all acted calmly, given the circumstances. We were then lynched at first opportunity through the agency of a misleading description given by the table DM. (Whether consciously or tinsensuously is irrelevant; the bias was established.)

I must stress that none of us came with the express idea of winning, experience puts you hopefully above that. We didn't need the prizes; we just came to have some fun. I felt that we were above most of players in ability — but the only manner in which we tried to demonstrate it was through playing — that being what we came to do. Even though we were eliminated we gave a good account and had a good gut-laugh over the whole thing when it was over.

This letter would not have been written, and I regret having to do so deeply, but a last rather uncalled for remark by the Head DM prompted me. I said to him, without any anger intended, that if he wanted us back, he'll have to be better organized. I was told in return I'd better get out of there or I would get my head kicked in.

I have tried not prejudice this letter, if it sounds like a horror story it was a horror story.

However, I'm not going to say that these people should never be able to hold a tournament again, as that can only hurt our wonderful game.

The intent is to:

A. Protect the players by making them aware of possible problem areas

B. Protect TSR's good-name i.e.: TSR cannot be held accountable for people's action; especially if they are bull-shitted to by organizers

C. Make potential tournament organizers aware of their responsibilities.

I hope you will print this letter for the reasons outlined above.

Michael J. Sutton,
Ontario, Canada

P.S.

A tournament guideline should be established and made available to potential organizers.

Dear Mr. Sutton:

Thank you very much for your letter of the 2nd. I am quite sorry to learn of the highly unpleasant experience you underwent participating in the D&D tournament . . . if indeed it could be called a tournament!

First, let me say that we often give prizes to groups who sponsor conventions and tournaments, doing so to help promote the hobby in general. We do not ask special billing when we do so. These are actual donations to help the gaming group. I fear we have no way to control any improper use of these donations — in use or advertising — short of refusing to make them, and that would be counter-productive.

Sadly, yours is not the first tale of woe connected with D&D tournaments. TSR has recently taken the stand that no tournament can be "official" unless we approve or run it, and perhaps we had better start publicizing this. We too make mistakes in tournaments, but not of the magnitude you relate regarding the Toronto affair.

As time and information are crucial in a tournament, your complaints, if valid, condemn the tournament to oblivion. I will suggest Tim Kask publish your letter and ask the sponsors to give

Continued on page 46

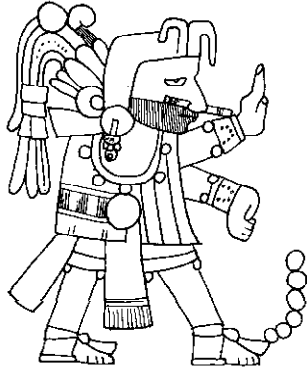

WAR OF FLOWERS

William B. Fawcett

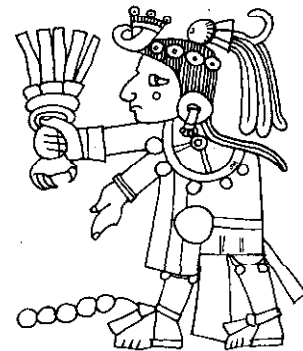

Only in the loosest sense, was the pre-conquest Aztec nation a nation in the European meaning of the word. The very concept of nation would have been virtually inconceivable to the average Aztec. He was a Texcocan or a Tlaxcalan. The Aztec nation was, in fact, a patchwork of city states with varying degrees of independence and mutual animosity. An individual's allegiance was to his clan and tribe. (Most cities were inhabited by one tribe which was determined by customs and deities worshipped more often than common ancestry.)

The Aztec "empire" was in fact a conglomeration of city states that formed rather fluid coalitions which were normally centered on the most powerful cities found in the area of present day Mexico City. In these coalitions there were normally one or two major powers who, by their size and military strength, were able to compel the lesser cities to join in their efforts. When a city was 'conquered' the result was the imposition of tribute and economic sanctions rather than social or political absorption, as occurred in Europe or China. This tribute was reluctantly paid to the victorious city only until some way to avoid it was found (such as an alliance to an even more powerful city). Any political or military alliance was then ruled entirely by expedience, and quickly and easily dissolved.

This constant shifting was demonstrated by the actions of Texcoco when Tenochtitlan, then the chief power, was attacked by Cortes. Texcoco joined with several other cities in aiding the Spanish. Just a few years earlier Texcoco had been the reluctant ally of Tenochtitlan in her unsuccessful war with Tlaxcalans. (During which the Tenochtitlans arranged to have the Tlaxcalans ambush a part of the Texcocans involved. Such treacheries were not uncommon.) Later the Spanish were able to play these former allies against each other.

The citizen of an Aztec city was imbued from birth with the concept that the city and tribe were important and the individual should act only in ways that benefited the whole. The concept of individualism we value would have been considered anti-social and obscene to the Aztecs. Though they amassed individual wealth and possessions most of the land was considered to either belong to the tribe outright or to be held in trust for the city by the individual. Anyone dying without an heir (male, son) automatically left his land and possessions to the city or clan for redistribution. Material wealth was considered less important than value to the tribe, as reflected by the positions held and honors received. If you do not realize how deeply this selfless spirit was ingrained in every citizen, it will be difficult to accept the attitudes demonstrated by captured warriors.

War itself was viewed by the Aztecs as a part of the natural rhythms. These rhythms were felt to permeate every level of existence and only by keeping in step to them could an individual and (more importantly) a tribe or city survive and prosper. Each day was seen as a battle between the sun and the earth. The sun losing every sunset and gladly sacrificing himself to the earth, so that men could prosper. Many of the workings of nature were viewed as being reflections of the rhythm of the war between the opposing natural and spiritual forces. War then took on a religious and ritual nature that both limited it in extent and made it part of the spiritual life of the community with strong metaphysical overtones. Rituals arose around the conducting of wars and to vary from them would have caused the war to lose its very reason for existing.

On the more mundane level wars were fought for Revenge, Defense, or Economic reasons. A common cause for the formal declaration of war was that a city's merchants were being discriminated against or attacked. (These merchants normally doubled as each city's intelli-

gence force and so were often harassed in times of high tensions.) Behind all political and economic justifications was always the strong force of the religious nature of war, and a never ending need for captives to sacrifice.

A common proximate cause for war was the failure of a vassal state to pay the tribute demanded. It is surprising to discover, but true, that in a system where tribute was one of the key ingredients, no system (such as hostages) was ever devised to guarantee the payment of tribute from a previously conquered area. If tribute was refused the only alternative was to go to war again.

The process of declaring war was long and elaborate. Followed in most cases, it left no room for the deviousness common in Aztec wars. The procedure to be followed was set in a series of real, but ritually required, actions. The actual declaration of war involved three State visits, often by three allied cities planning to attack. The first delegation called on the chief and nobles of the city. They boasted of their strength and warned that they would demand some of the nobles as sacrifices if the war ensued. The group would then retire outside the city gate and camp for one Aztec month (20 days) awaiting a reply. This was normally

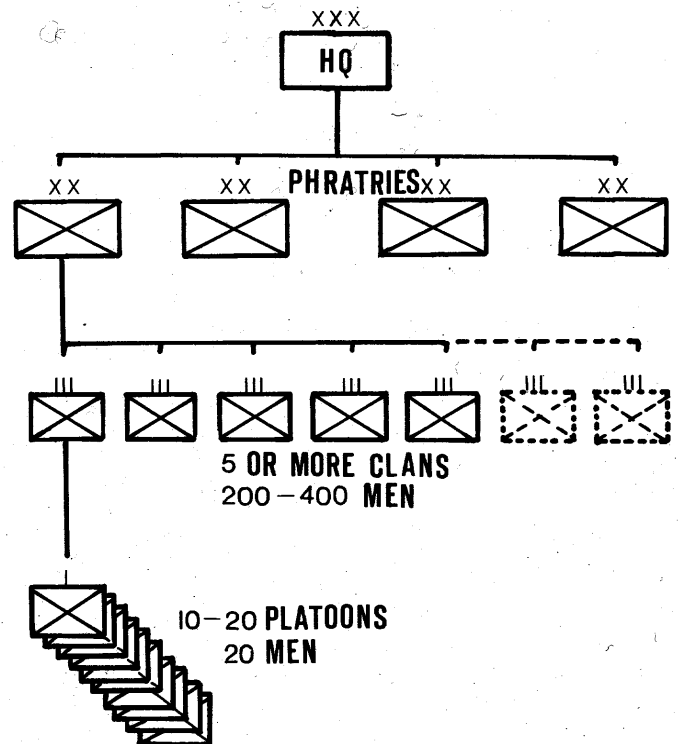

given on the last day and if the city or coalition did not accept their terms, token weapons were distributed to the nobles. (This was so that no one could say they defeated an unarmed foe.)

The second delegation would then approach the city's leading merchants. This second delegation would describe the economic "horrors" of a defeat, comparing them badly to the terms offered, and generally trying to persuade the merchants to get the chiefs to surrender. This delegation then also retired for a month to await a reply. Should

this also be negative a third and final delegation would arrive. This group was to talk to the warriors themselves. They would harangue a mass meeting with reasons why they should not fight and tales of the horrors of battle. Once more they would ask for the city to meet their terms (normally a virtual surrender or the loss of some territory) and then retire to a camp for the ritual one month wait. Finally, after all of this, the armies (having had plenty of time to assemble) would meet in a battle. Here any deception was acceptable and a cunning general as valuable as a courageous one.

The leadership of the Aztecs was the same in times of peace and war. Between wars the officers served as the administration, judiciary, and civil service of the city. Heading this organization was the Supreme War chief or Tlacatecuhtli. This was the position held by the unfortunate Montezuma in Tenochtitlan when Cortes arrived. Each clan was assigned to one of four phratries each having its own leader called a Tlaxcola who served as their divisional commander in wartime, and on a council with the other three that ran the actual administration of the city in times of peace. The head of each clan served as a regimental commander and was known as a Tlochcautin. In peace he would serve in a role similar to the English Sheriff. Below the clan level was a unit of approximately 200 to 400 men. This was the equivalent of our company and was really the largest unit over which any tactical control could be held once a battle began. The smallest regular unit was the platoon of 20 men. This organization was rigidly observed by the major cities and was such an integral part of Aztec culture that the symbol for '20' was a flag such as each platoon had.

The military techniques of the Aztecs were inferior to those of Europe or China at that time. This is probably due primarily to the fact that while ritually involved and religiously important, war was less developed as a social solution in pre-conquest Mexico. This was caused by several factors, the major one being that the population density of the area was much less than in other parts of the world. In the period immediately preceding the Spanish only one area had really felt the pinch of overpopulation. This was the area around Lake Titicocca occupied today by Mexico city. Here is where the powerful and most warlike cities developed. Even then their tradition of war (as opposed to individual combat) was only a few hundred years old as opposed to thousands in other lands. The result was that while having a warrior attitude and with war deeply ritually ingrained in their culture, the techniques of battle were still quite unsophisticated and basic.

One reflection, of the undeveloped nature of Aztec wars was the absence of any sort of drills. Units acted as a group only during civil duties, or during the several religious ceremonies that they assembled for each year. The tactics of a battle then most often resembled the mass or swarm tactics of biblical times.

Another factor mitigated in favor of only limited military activities. This was the fact that it was extremely difficult for an army to engage in an extended campaign. Since the army was also the work force, a campaign during the planting and harvest seasons was prohibited. This is especially true since the agriculture was not so efficient as to be able to support the massive priests hierarchy and a standing army of any size. Nor could an army live off of the country, since it was likely that the area they would travel through would be inhabited by several city states that were not involved in the war and were independent of those involved. This meant that it was necessary not only to set up supply depots along any proposed route, but also to negotiate permission to trespass on other cities' lands.

The marginal nature of the agriculture was also such, that sieges that lasted any length of time were virtually impossible. The besieging army would as likely starve as the besiegers. The result of this was that formal walls and other fortifications were rare. In their place canals (useful in trade also) were often used with portable bridges. Many cities were also located in easily defensible terrain such as on a mountainside or on

the end of a narrow isthmus. There has also been no evidence that siege weapons of any sort were developed or used to any extent.

Despite all of the problems listed the Aztecs were able to wage campaigns over a wide area of Mexico. Most often these were fought with armies made up chiefly of local allies with a contingent of Aztecs to stiffen them. In some cases it is recorded that the Aztecs were forced to engage in the laborious technique of having to subdue each of the towns and cities on their route.

The weapons and tools of the Aztecs were basic and simple in nature. Rather than developing new variations of weapons the efforts of the Aztecs went into elaborate decorations on them. There were four main weapons used by the Aztec warrior. A wooden club with sharp obsidian blades was used. Javelins were common and often used with a throwing stick called an *atl-atl*. The bow and arrow was also found in most armies as was a heavy javelin or lance for in-fighting. Occasionally a clan would have a tradition that caused some of them to employ the sling or spears. Axes were used as tools, but do not seem to have been a regularly used weapon.

The bulk of the weapons in a city was kept in an arsenal called the Tlacochoalco or roughly the "house of darts." One of these was found in each quarter of a city and held the weapons for five clans (one phratry). These arsenals were always located near the chief temples and were designed with sloping walls that enabled them to serve as a fort. The Tlacochoalcos served as the headquarters, assembly points and rallying points for the defenders of a city. Religious ceremonies were also held there by the military leaders and "Knights."

The shields of the Aztecs were wickerwork covered with hide. Most were circular and elaborately painted and decorated. Skins and feathers were also often attached to augment their beauty. The warriors who used the clubs carried shields, but those using the large javelin or lance were unable to as they needed both hands to employ their weapon. Body armor was made of quilted cotton hardened in brine. This was quite successful against the weapons used by other Aztecs, (and useless against crossbows and steel swords). This cotton armor was in fact quickly adopted by the conquistadores as being effective enough and much cooler than their own metal armor. The quilted armor was often dyed bright colors, brocaded and embroidered with intricate designs and symbols.

Wooden helmets were worn by some warriors and the chiefs, (who rose to chief by being outstanding warriors). These quickly became elaborate and bulky. It was often necessary for them to be supported by shoulder harnesses. Most headdresses or helmets were stylized animals or protecting deities. The more elaborate the helmet the more renown the warrior in battle. There is mention of copper helmets in a few codexs, but none have been found and in any case would have been extremely rare. Metal working for tools and weapons was not advanced and obsidian was the basic (and effective) material.

As during comparable periods on other continents the Aztecs wore no uniforms. Each side would identify itself with a prominently worn badge or insignia. This often would be elaborated to show also the rank of the wearer. With the myriad of colors in the cotton armor and the elaborate helmets an Aztec battle was a kaleidoscope of swirling colors.

A young warrior was taught the use of weapons as part of his schooling. (All males were soldiers.) All boys were required to either be tutored or to attend the Telpuchcalli or public school. Later, in lieu of unit training and drills, a new warrior was attached to veteran for his first battles. This program was actually quite similar to the apprenticeship or squire systems developed for the same purpose in medieval Europe.

The tactics and weapons of the Aztecs were greatly influenced by the goal of their wars, captives and whatever tribute or land demanded. It was the ultimate sign of ability in a warrior to bring back from a battle a live enemy suitable for sacrifice. Warriors then often strived not to kill their enemy, but to knock him out or deliver a non-fatal, but disabling wound. A victory was valued then by the number of enemies captured, not killed. To this end warriors were trained rigorously in individual combat, with little emphasis on formations or teamwork. The best warriors were admitted to select societies of "knights." Only the most skillful (as judged purely by the number of captives taken) were allowed to enter. These were known as the Knights of the Eagle, the Knights of the Ocelot (Tiger), and a less common group the Knights of the Arrow.

Congratulations & Good Luck

from TSR Periodicals

to Vicky Miller & Brian Blume

who will become Mr. & Mrs. Blume on May 12, 1979

Helmets depicting their namesakes were often worn and ceremonial costumes that copied their coloration were worn in ceremonies and into battle. These orders performed dances and participated in rituals at the Tlacoachcalco. They also participated in the mock battles of sacrifice. These Knights received large shares of land when conquered territories were divided between the warriors. (This practice gave an occupation force a way to support itself.)

A warrior who was slain in battle or sacrificed after a defeat was guaranteed entry into a special warriors heaven. This was to be found in the East and a special heaven for women who died in childbirth was in the West (they were felt to have sacrificed themselves for a potential new warrior). To die in these ways was the greatest honor a defeated warrior could receive. (Non-warriors and cowards were sold into slavery.) To some it was the culmination rather than the ruin of the lives. There is recorded the story of Tlahuicol who was a Tlaxclan chief. Having been captured in battle he was given the honor of the mock-gladitorial sacrificial combat. This meant that he was chained to a large round stone representing the sun and given wooden weapons, (no obsidian points or edges), and attacked one at a time by members of the Knights of the Eagle. In single combat he managed to kill a few and wound several more. The combat was stopped and Tlahuicol was offered the choice of the generalship of the Tlaxclan army or to be the sacrifice in their highest ritual. He choose to be the sacrifice, viewing it probably as the greater honor.

These sacrifices were viewed then not as a punishment (criminals were killed or enslaved, but never sacrificed), but as an opportunity to give their final great contribution to their communities. It was believed that the sacrifices were needed to prevent the wrath of the gods and bring anything needed such as the rain or spring. Perhaps the only close honor was to obtain a prisoner in battle.

A typical Aztec battle consisted of both sides coming upon each other, quickly forming up to charge and then rushing at each other amid fierce cries. Quickly this would break down into many combats between individuals and small groups. Both sides would contend, until one seemed to be gaining an advantage. The other would then break and run, avoiding capture to minimize their enemy's victory. Often the defeat and capture of a major chief was enough to cause the morale of one side to break.

Many stratagems were used. Feints and deception were common, especially in the battles between the major cities. It was a common maneuver for one side to fake a route and then lead their pursuers past a second force in hiding. This force would then fall on the rear of their pursuers while the routing force rallied. A cunning war chief was considered as valuable as a courageous one. Whoever won, sacrifices were assured and the gods appeased.

If there was no war occurring, then an artificial war was instituted to assure sacrifices and give the warriors an opportunity to prove their skills. This was incongruously named the "War of Flowers." Though it was an artificial war those participating in it fought a very real battle. Many died and many more were captured for sacrifice before one group would concede defeat.

Invited to participate were the best Knights and warriors of two or more rival states. The best warriors contended to be able to participate. If he won, a warrior would gain in renown throughout the cities. If he was killed, the warrior was given the honor of cremation. Reserved only for warriors, cremation guaranteed entrance to the special warriors' heaven. Finally, if defeated and captured a warrior was given the supreme honor of being sacrificed. So popular were these Wars of Flowers that some were repeated annually for years.

The institution of war among the Aztecs evolved into something quite different from that which we perceive. It was foremost a means by which an individual could serve the all important tribe or city. It was an inherently ritualized and mystic event of deep-meaning and necessity. It was the only means by which captives needed to appease their blood-thirsty gods (actually it was the hearts they tore out and offered still throbbing). In a truly collective, military society it was the one area where an individual could gain renown and prestige.

Aztec Command Structure
 Tlacoatecuhtli — War chief, C in C
 Tlaxcola — Phratry Commander (4)
 Tlochcautin — Clan Commander

XOCHIYAOTL

Rules for Pre-Hispanic Mexican Warfare

Neal M. Dorst

1.0 introduction. The following is a set of rules for conducting miniature battles of the Pre-Hispanic Mexican (300-1500 A.D.) era. This era saw the rise and fall of many Indian empires and kingdoms from the great to the petty. The Mesoamericans developed a method of warfare unique and totally independent of Western European influence. In some respects it is primitive and in others it is highly advanced.

The game is played in a series of turns in which the opposing sides make simultaneous moves in an effort to capture or kill as many of the opposing army as possible. It is recommended that a referee be on hand to run the game, settle disputes, and so forth. Each turn follows the sequence of play:

- 1) Weather determination
- 2) Sacrifices
- 3) Projectile Firing & Effect
- 4) Movement
- 5) Hand-to-Hand Combat
- 6) Prisoner Declaration

Each of these will be explained in their sections.

2.0 scale. Each unit or figure represents 20 men, each man in the unit having the same weapon and strength. One turn equals two minutes. One inch of horizontal distance equals 25 yards and one inch of vertical distance equals five feet. The bases on each unit should be 1.5 x 1.5 cm except for Spanish Cavalry which should be 1.5 x 3.5 cm.

3.0 set up. A playing field should be set up according to the above scale taken from either real sources or the reader's imagination. It should have the terrain divided into clear, uneven (including forest), rough (mountains), and swampy for purposes of movement.

3.1. Each of the opposing sides has a value assigned called its Military Prowess number. This determines their units strength (see Table 1). The number ranges from 1 to 5.

Table 1

| Military Prowess | 1 | 2 | 3 | 4 | 5 |
|------------------|---------|---------|---------|---------|---------|
| # Ratio | 1 | .9 | .75 | .6 | .5 |
| Die # | | | | | |
| 1 | 1 | 2 | 2 | 3 | 3 |
| 2 | 2 | 2 | 3 | 3 | 4 |
| 3 | 2 | 3 | 3 | 4 | 4 |
| 4 | 3 | 3 | 4 | 4 | 5 |
| 5 | 3 | 4 | 4 | 5 | 5 |
| 6 | 4 elite | 4 elite | 5 elite | 5 elite | 6 elite |

Determine the Military Prowess number for each side, either by chance or by agreement. The number of units available to each side is then determined by the ratio # of Table 1. (example: If one side of M.P. #1 has 500 men then a side of M.P. #5 would have 250 men.) For each 20-man unit the player rolls a die and consults Table 1 which gives the strength of that unit and whether or not it is elite. This should be recorded for reference later.

Each side then chooses which side of the field to enter. They may also determine which side had access to the field prior to the battle.

3.2. Each side should now choose the weapons for each unit. Each army should have a leader and a priest unit. The leader unit is always 6 elite and priest unit is 1 elite. Over half the combat units should be armed with hand-to-hand weapons and of these there should be a 1 to 2 ratio of club units to war club units. Of the projectile tiring units over half should be armed with atl-atl.

3.3. Leader units consist of 20 men armed with war clubs with a strength value the maximum for their Military Prowess. When attacked or shot at the leader is the *last* man caught or killed.

All projectile firing units and priest units are armed with swords if they are engaged in hand-to-hand. The projectile units drop one in strength value when involved with hand-to-hand and priests are 1.

3.4. The Mexicans had a form of quilted cotton armor known as Ichahuipilli. Players may designate 25% of their forces as having this armor. Such units should halve the figures in Table 4 or shift the enemy's odds column one to the left in Table 8 for the appropriate combat situation.

3.5. Each army should be broken down into 10 unit (200 man) divisions. Each unit in a division should be within 2" of another member of the unit, and so on until there can be traced a chain of such association linking all members of the division together. At least one member of each division must be within 24" of the leader unit. Any violations cost each member of the division one morale point.

3.6. Any side having prior access may conceal five elite units in any area of rough or uneven terrain. The side does so by informing the referee which units will hide where. These units remain hidden throughout the battle until they move or an enemy unit passes within 2".

4.0 weather. Every 15 turns the referee will roll a die and consult Table 2. This will determine the weather for the next 15 turns. The weather affects morale and projectile firing.

Table 2

| Season: | Winter | Spring | Summer | Fail |
|---------|--------|--------|--------------|--------------|
| Die# | | | | |
| 1 | Snow | Rain | Thunderstorm | Thunderstorm |
| 2 | Snow | Rain | Thunderstorm | Rain |
| 3 | Clear | Rain | Rain | Rain |
| 4 | Clear | Clear | Rain | Clear |
| 5 | Clear | Clear | Clear | Clear |
| 6 | Clear | Clear | Clear | Clear |

Clear: No effects

Rain: All morale numbers down 1

Snow: All morale numbers down 1, projectile ranges halved

Thunderstorm: All morale numbers down 2, projectile ranges halved

The effects last for the full 15 turns.

4.1. Either side may sacrifice 60 enemy men in 3 consecutive turns and change the Weather to Clear for the rest of that 15 turn period. However these sacrifices may not contribute to morale raising (see Prisoners & Sacrifices).

5.0 projectile firing and effect. There are three projectile firing weapons available. They are the bow and arrow, sling and stone, and the atl-atl (javelin). In order for a projectile firing unit to fire on an enemy it must be able to sight the enemy and it must be in range.

5.1. In order to sight an enemy one must be able to hold a straight edge from the center of the firing unit to the target with no intervening objects five feet or taller (relative to the firing unit's height). Forests may be considered 20 feet tall relative to their own level. Units in hiding or in a forested area may *not* be sighted.

5.2. To find the maximum ranges of the weapon consult Table 3. Don't forget possible halving due to weather.

Table 3

| Weapon | Max Range | Rate of Fire | % Hits |
|---------|-----------|--------------|-----------------------|
| Bow | 4" | 12/turn | 100% x (2"/R) x (s/6) |
| Sling | 3.5" | 8/turn | 100% x (1"/R) x (s/6) |
| Atl-atl | 2" | 4/turn | 100% x (1"/R) x (s/6) |

After an appropriate target has been selected the firing unit refers to Table 3. The number of men in the unit is multiplied by the rate of fire (all rounds in a turn must be shot at the same target). Next the % Hits is calculated by placing the range in inches in R and the firing unit's strength in s. Multiply % Hits with the total number of shots to give the number of hits (Note: % Hits may *not* exceed 100%, and 10% should be subtracted if the target will be moving this turn). Now multiply the number of hits by the appropriate % in Table 4 to get the number of fatalities (round off) and, in the case of the sling (in parenthesis), the number rendered unconscious. These remain unconscious until the beginning of next turn, and should the unit move before then they are lost to that unit. Such abandoned men may be claimed as prisoners by the enemy unit moving over the spot in this turn. If not, they are just lost from the game.

| Weapon | Table 4 | |
|---------|------------|------------|
| | Normal Men | Elite |
| Bow | 2 % | 1% |
| Sling | 1.5% (3%) | .75%(1.5%) |
| Atl-atl | 5% | 2.5% |

(example: a 15 man, 3 strength unit fires sling at an elite unit 1.5" away. That is 15 man x 8/turn or 120 stones fired at 100% x 1"/1.5" x 3/6 or 33% hits which is 39 hits with .75% fatalities or 0 killed and 1.5% unconscious or 1 out.)

5.4. To round off .5 or higher is 1. and .4999 or lower is 0.

5.5. Units which fired in one turn may not move during that turn. However a unit may fire only half its rate and then move half its rate.

5.6. Projectile firing units may fire at 1,2,3, or 4 targets per turn (at least one round of fire at each target). For multiple targets the % Hit should be halved, thirded, or quartered as appropriate.

6.0 movement. The amount of movement allowed a unit is dependent on the terrain it is moving over (see Table 5).

Table 5

| Clear | Uneven | Rough | Swampy | 180 degrees |
|-------|--------|-------|--------|-------------|
| 4" | 3.75" | 2.5" | 1.5" | .5" |

In order for a unit to turn 180 degrees around it must expend .5" of its movement.

6.1. When a unit moves from one terrain to another the referee should calculate how many inches of movement are left to the unit (example: a unit moves from clear to swampy after moving 3". The inches left is equal to 1/4 times 1.5 which is .38").

6.2. A unit may *not* move through an enemy unit, and if it passes within 1/2" of an enemy unit it must stop. If it passes within 2" of a concealed enemy the enemy is exposed but the unit may continue with its move.

6.3. A unit moving up a hill expends 1". A unit moving down a hill gains an extra 1".

7.0 hand-to-hand combat. At the end of the movement turn if any opposing units are within 1/2" of each other they may engage in hand-to-hand combat. The players then calculate the strength ratio between the two units starting with their units' strength and using the multipliers given below. The unit with the lower number is called the defender and is given three options: defend, aggressive, or disarm. If the option is defend the strength of the unit is doubled and the turn passes to the aggressor. If the option is one of the others then the appropriate CRT is consulted (see 7.4).

When the aggressor's turn comes he may choose either aggressive or disarm and then consults the appropriate CRT.

7.1. A facing multiplier is given to the attacker if its unit faces the back (hind 180 deg.) of the defender. In this state the attacker is given a 3/2 multiplier.

7.2. If a unit was not engaged last turn or under fire, and this turn it traveled its full movement to engage a stationary enemy it is given a shock multiplier as follows:

| Table 6 | |
|--------------------|------------------|
| Ratio of strengths | Shock Multiplier |
| less than 1:1 | x1 |
| 1:1 | x4/3 |
| more than 1: 1 | x5/3 |

7.3. Multipliers are given due to differences in weaponry as given below

Table 7

| Multiplier is given to player 1 | | | | |
|---------------------------------|-------|-------|------|----------|
| Player 1: | Sword | Lance | Club | War Club |
| Player 2 | | | | |
| Sword | x1 | x5/3 | x1 | x4/3 |
| Lance | x1/3 | x1 | x1/3 | x2/3 |
| Club | x1 | x5/3 | x1 | x4/3 |
| War Club | x2/3 | x4/3 | x2/3 | x1 |

7.4. When either the attacker or defender chooses the aggressive or disarm option they consult the appropriate section of Table 8 and look under the modified strength ratio for his weapon. A die is then rolled and if the attacking unit is an elite unit it subtracts 1 from the roll. The number given is the percent of men killed. Those given in parenthesis are the percent disarmed.

Table 8
AGGRESSIVE

| | | | | | | | | | | | | |
|----------|-----|-----|-----|-----|-----|-----|-------|-----|-----|-----|-----|--|
| Weapon | | | | | | | | | | | | |
| Sword | 1:4 | 1:3 | 1:2 | 1:1 | 2:1 | 3:1 | 4 : 1 | 5:1 | 6:1 | 7:1 | 8:1 | |
| Club | 1:5 | 1:4 | 1:3 | 1:2 | 1:1 | 2:1 | 3 : 1 | 4:1 | 5:1 | 6:1 | 7:1 | |
| War Club | 1:6 | 1:5 | 1:4 | 1:3 | 1:2 | 1:1 | 2 : 1 | 3:1 | 4:1 | 5:1 | 6:1 | |
| Lance | 1:7 | 1:6 | 1:5 | 1:4 | 1:3 | 1:2 | 1 : 1 | 2:1 | 3:1 | 4:1 | 5:1 | |
| Die# | | | | | | | | | | | | |
| 0 | — | — | 5% | 5% | 10% | 10% | 20% | 20% | 30% | 40% | 50% | |
| 1 | — | — | — | 5 | 5 | 10 | 1 0 | 20 | 20 | 30 | 40 | |
| 2 | — | — | — | — | 5 | 5 | 1 0 | 10 | 20 | 20 | 30 | |
| 3 | — | — | — | — | — | 5 | 5 | 10 | 10 | 20 | 20 | |
| 4 | — | — | — | — | — | — | 5 | 5 | 10 | 10 | 20 | |
| 5 | — | — | — | — | — | — | — | 5 | 5 | 10 | 10 | |
| 6 | — | — | — | — | — | — | — | — | 5 | 5 | 10 | |

DISARM

| | | | | | | | | | | | | |
|----------|-----|-----|-----|-------|------|------|-------|------|------|------|------|--|
| Weapon | | | | | | | | | | | | |
| Lance | 1:3 | 1:2 | 1:1 | 2 : 1 | 3:1 | 4:1 | 5 : 1 | 6:1 | 7:1 | 8:1 | 9:1 | |
| Club | 1:4 | 1:3 | 1:2 | 1 : 1 | 2:1 | 3:1 | 4 : 1 | 5:1 | 6:1 | 7:1 | 8:1 | |
| Sword | 1:5 | 1:4 | 1:3 | 1 : 2 | 1:1 | 2:1 | 3 : 1 | 4:1 | 5:1 | 6:1 | 7:1 | |
| War Club | 1:6 | 1:5 | 1:4 | 1 : 3 | 1:2 | 1:1 | 2 : 1 | 3:1 | 4:1 | 5:1 | 6:1 | |
| Die # | | | | | | | | | | | | |
| 0 | — | — | — | 5 % | 5% | 10% | 10% | 20% | 20% | 30% | 40% | |
| | | | | (10) | (10) | (20) | (25) | (30) | (40) | (45) | (50) | |
| 1 | — | — | — | — | 5 | 5 | 1 0 | 10 | 20 | 20 | 30 | |
| | | | | | (10) | (10) | (20) | (25) | (30) | (40) | (45) | |
| 2 | — | — | — | — | — | 5 | 5 | 10 | 10 | 20 | 20 | |
| | | | | | | (10) | (10) | (20) | (25) | (30) | (40) | |
| 3 | — | — | — | — | — | — | 5 | 5 | 10 | 10 | 20 | |
| | | | | | | | (10) | (10) | (20) | (25) | (30) | |
| 4 | — | — | — | — | — | — | — | 5 | 5 | 10 | 10 | |
| | | | | | | | | (10) | (10) | (20) | (25) | |
| 5 | — | — | — | — | — | — | — | — | 5 | 5 | 10 | |
| | | | | | | | | | (10) | (10) | (20) | |
| 6 | — | — | — | — | — | — | — | — | — | 5 | 5 | |
| | | | | | | | | | | (10) | (10) | |

(example: a 15 man unit, strength 3, armed with war clubs meets face to face with a 10 man unit, strength 5, armed with clubs and no shock strength. The first unit's modified strength (due to weapon difference) is 4 and elects to fight aggressive against the other unit's strength of 5. The ratio of 1:2, war club, aggressive, and die roll of 2 gives 5% of 10 which rounded up is 1 man killed. The other unit elects to fight disarm and rolls a 1. A club ratio of 1:1, roll of 1 yields a blank and no men are killed or disarmed.)

7.5. No more than six units may attack an enemy unit in one turn. A unit may not attack an enemy unit if it is being attacked by a different enemy unit. If more than one unit attacks an enemy unit each attack is calculated separately with damage being cumulative and the order of attacks at the aggressor's choice.

8.0 prisoners and sacrifices. If at the end of the Hand-to-Hand phase two opposing units are within 1/2" of each other and one or both units have either unconscious or unarmed men then the opposing unit may claim these as prisoners provided they have the same number of active, armed men plus at least half the number of enemy active, armed men to act as a covering force.

(example: Two units face each other, one has five unarmed men and ten armed men; the opposing force must have five plus five or ten active, armed men in order to take prisoners.) It is possible for two facing units to take prisoners from each other.

8.1. Any unit that has taken prisoners in one turn must on the next movement turn retreat from combat and move to the nearest, friendly priest unit. Should there be none, then the unit must move off the edge of the field that it entered. It must wait 1 turn with the priest unit or 2 turns off the field in order to turn over its prisoners. After that it is free to move and fight again. The player must keep track of the number of prisoners taken.

8.2. Sacrifices may be made to change the weather (see weather) or to improve morale. In order to do this a priest unit must sacrifice 20 of its prisoners in one turn (which is the maximum rate at which they may do this). For each turn in which a priest unit sacrifices 20 men all friendly units add 1 to their morale level. This effect ends at the end of the turn and is not cumulative. Prisoners taken off the field may not be sacrificed.

8.3. Any unit that captures prisoners goes up 3 levels in Morale when it returns to combat. This effect lasts for 15 turns.

9.0 morale. A unit will have its morale level checked if it either comes under fire, engages in hand-to-hand combat, or an enemy unit leaves concealment within 2" of it.

9.1. The following formula is used to compute morale level:
Previous level (0 at start) + # of friendly units within 2" - # of enemy units within 2" + (unit's strength - 3)/2 + (men left in unit -10)/5 + any appropriate additives

The additives are:

- 1, -2 weather
- +1 sacrifices
- 1 under fire
- 1 enemy units out of hiding 2"
- +3(-3) Enemy (Friendly) leader caught or killed
- +2(-2) Retreating enemy (friendly) units in sight
- +2 Friendly leader engaged in combat

9.2. The resulting number is referred to Table 9.

Table 9

| Morale level | Combat option | Controllability |
|--------------|-----------------|-----------------|
| M4 | Must advance | No new orders |
| M3 | Must advance 3" | No new orders |
| M2 | May advance 2" | New Orders |
| M1 | May advance 1" | New Orders |
| M0 | Stand | New Orders |
| M-1 | May retreat 1" | New Orders |
| M-2 | May retreat 2" | New Orders |
| M-3 | Must retreat 3" | No new orders |
| M-4 | Must retreat | No new orders |

9.3. If the unit has engaged in hand-to-hand combat then it follows the combat option. For M4 it must advance (within movement restric-

tions) towards the nearest enemy unit. For any positive morale it may either advance to the given distance or, excepting M3, retreat or stand (Note: this takes place during next movement phase after the morale check). For M-4 the unit must retreat to its side of the board. For negative values the unit may retreat up to the given value, or, excepting M-3, retreat or stand.

9.4. If the unit is not engaged in hand-to-hand then it may be moved as the player pleases except when controllability says no new orders. Then the player must follow instructions given under Combat option.

9.5. The morale level remains until conditions warrant another check. Morale should be checked after Projectile Firing, Movement, and Hand-to-hand Combat for those units affected.

9.6. When a unit with M-4 retreats from the field it is lost. If it passes within 2" of the leader unit it may check its morale (should it still be M-4 it continues to retreat). Should a leader unit retreat from the field it counts as caught or killed for other units' morale checks.

10.0 ending and victory. The battle ends when one or both sides retreat from the field, by mutual agreement, when a prior time limit is reached, or one side is completely captured or killed.

10.1. Each side totals its points using the following scale:

- Enemy Leader captured + 5
- Enemy Leader killed + 3
- Enemy Elite captured + 4
- Enemy Elite killed + 2
- Enemy Man captured + 3
- Enemy Man killed + 1

For each man sacrificed count as captured and subtract 1

Subtract the smaller total from the larger and consult Table 10 for degree of victory.

| | |
|---------|---------------------|
| 0-50 | Draw |
| 51-100 | Minimal Victory |
| 101-150 | Victory |
| 151+ | Superlative Victory |

10.2. The players may elect to fight a Xochiyaoyotl (War of Flowers) in which the object is to take as many prisoners as possible. Leader units may *not* be attacked unless they attack first. Units are restricted to either the Disarm or Defend options in hand-to-hand. The point scale is as follows:

- Enemy leader captured + 10
- Enemy elite captured + 5
- Enemy man captured + 3
- All sacrifices count as captured
- Enemy man killed -1

Spanish Optional Rules

1.00 introduction. These rules are to be used for battles with Spanish units and their allies. These take precedence over basic rules.

2.00 scale. All cannon units have five cannons and 20 men. In firing only count number of cannons, and any cannon with one to four men manning it may fire.



Spanish Morion

3.00 set-up. All Spanish units are rated 6 elite. The Spanish ratio # is .25, but this does not include allied Meso-american units. (Example: one side has 500 M.P. #1 units so there are 125 Spanish and 375 allies of M.P. #3)

3.01. Army setup: One leader on Horse. Over half force armed with hand-to-hand weapons, over half projectiles must be crossbow, and less than 10% of force may be either Horse or Cannon.

3.02. All Spanish units have steel armor which acts just like Ichahuipilli. However, Ichahuipilli is *not* effective against either Arquebusier or Cannon units.

4.00 weather. Both cannon and arquebusier units may *not* fire in Thunderstorm. All ranges halved as given.

5.00 projectile firing and effect. For the Spanish units there are three projectile firing weapons: Crossbow, Musket, or Cannon (Falconette). Use the following as you use Table 3 and Table 4.

| Weapon | Max Range | Rate of Fire | % Hits |
|-------------|-----------|--------------|----------------|
| Crossbow | 6" | 8/turn | 100% x (4"/R) |
| Arquebusier | 3" | 2/turn | 100% x (1"/R) |
| Cannon | 30" | 1/turn | 100% x (20"/R) |

| Weapon | Normal | Men | Elite |
|-------------|--------|------|-------|
| Crossbow | | 3% | 1.5% |
| Arquebusier | | 5% | 2.5% |
| Cannon | | 100% | 50% |

6.00 movement. The following Table is mounted and artillery units.

| Unit | Clear | Uneven | Rough | Swamp |
|--------|-------|--------|-------|-------|
| Horse | 8" | 7" | 4" | 3" |
| Cannon | 3" | 2.5" | 2" | — |

6.01. Cannon units may not travel through swampy areas.

6.02. Spanish units must travel in column, i.e., one or two units abreast in line, facing the same way, and with less than 2" between each unit. Movement is as normal.

7:00 hand-to-hand combat. Spanish units may fight in column or line. Line is a one-unit abreast column with units facing to the side instead of the front. Indian units have a 2/3 multiplier unless they have a canceling shock multiplier.

7.01. All weapon multipliers are given to the Mexican units.

| | Sword | Lance | War Club | Club |
|-------------|-------|-------|----------|------|
| Horse | x1/2 | x1 | x1/3 | x1/3 |
| Steel Sword | x2/3 | x4/3 | x1 | x2/3 |
| Pike | x1/3 | x1 | x2/3 | x2/3 |

7.02. Mexican units attacking a Spanish unit must use either the Disarm or Defend option. Spanish and their allies have the full set of options.

7.03. For Steel Sword use the Sword odds in Table 8. For Pike use Lance, and for Horse Swordsmen use Club.

8.00 prisoners and sacrifices. Spanish units and their allies may take prisoners, but they may *not* sacrifice them. Spanish units pass prisoners on to ally's priest for holding.

8.01. Spanish prisoners must be sacrificed by their captors before any Indian allies. However, they may be mixed to make a unit of 20.

9.00 morale. The following additives may be used:

- +2 sacrifices with Spanish captives
- 2 under Spanish fire
- 1 engaged in Hand-to-hand with Horse unit
- 1 Spanish enemy within 2"
- + 1 Spanish friend within 2"

10.00 ending and victory. Add the following points:

- Spanish Leader captured + 10
- Spanish Leader killed + 5
- Spanish man captured + 5
- Spanish man killed + 3

Count sacrifice as capture minus 2

10.01. Spanish do not participate in Xochiyaoyotl battles.

Finieous Fingers Fred and Charly in: "the great escape" or
A typical day in the wizard's lab Part I

by J.D.



VARIETIES OF VAMPIRES

by R.P. Smith

After considerable research I have found several different types of vampires from classical legends around the world, and arranged them in D&D format. I have not included *all* known vampires, just the more interesting ones.

Number appearing, armor class, hit dice, and treasure are the same for all vampires. Normal weapons will not hurt any vampire. All types of vampires will avoid mirrors, garlic, or crosses. With one exception, all vampires will go into gaseous form if they lose all their hit points by magic.

One must also consider the question of origin. If people can only become vampires through the bite of a vampire, where did the first one come from? According to the legends, the means can range from a simple death-bed curse and excommunication, through ancestry (s.g. one type was to be an Albanian of Turkish origin, another was to have red hair), through witchcraft, to violent death. The latter one is the easiest method for D&D. Hence, any body left unguarded without a Bless spell from a cleric will become a vampire within seven days.

| Type | Movement | Usual location |
|-------------|----------|-------------------|
| common | 12/18 | anywhere |
| asanbosam | 12/0 | jungle, plains |
| burcolakas | 12/18 | mountains |
| catacano | 12/18 | mountains |
| lobishumen | 15/0 | jungle |
| ekimmu | 12/18 | desert |
| blautsauger | 12/18 | mountains, forest |
| mulo | 12/18 | mountains, forest |
| alp | 0/24 | forest, plain |
| anananngel | 0/24 | jungle |
| krvopijac | 12/18 | mountains, forest |
| ch'ing-shih | 12 | anywhere |
| vlkodlak | 12/18 | mountains, forest |
| bruxsa | 12/18 | anywhere |
| nosferat | 12/18 | mountains, forest |

Asanbosam (Africa): Men (9 hit dice), women (8 hit dice), or children (7 hit dice) who look normal except for a pair of books instead of feet. They can charm at minus 3, (except against clerics, whom they avoid) and can throw a single sleep spell per night. They can call 3-18 leopards or 2-12 tigers. Only a cleric can kill the asanbosam.

Burcolakas (Greece): It has a swollen, tense, hard skin. It can scream once per night which deafens all in hearing range for 24 hours, no saving throw. It can also kill, not only by draining life levels, but by naming its victim by name and commanding the victim into a fatal action. It can imitate any voice it hears, with as much of a chance of being detected as an assassin has of being discovered in disguise. It controls 10-100 rats, but no wolves. To defeat: cut off and burn its head.

Catacano (Crete, Rhodes): Always grinning with very white teeth. When not sucking blood, the catacano is busy doing toothpaste commercials. It spits blood (see giant slug for chance of hitting) which causes horrible burns. It can charm at minus 2. To defeat: burn its nails, boil its head in vinegar, or submerge its body in salted water.

Lobishumen (Brazil): It looks like a small, stumpy, hunch-backed monkey with a yellow face, bloodless lips, black teeth, bushy beard, and plush-covered feet. It can charm at minus 4 and makes its victims (all women) into nymphomaniacs, if they survive. Women killed by a lobishumen while under its charm become succubi. There is a 60% chance that any woman who doesn't die while charmed by a lobishumen will be a nymphomaniac permanently. To defeat: Get it drunk, crucify it to a tree, then stab it with a stake through the heart.

Ekimmu (Assyria): Invisible even while it attacks, it can charm at minus 1. It can also *magic jar* its victim. To exorcise the vampire in this state, a clerical *dispel evil* is needed, with a 50% chance of success when the cleric is the same level as the ekimmu, plus or minus 5% per level difference. To defeat: Subdue it with magic weapons long enough for it to be killed with a wooden sword.

Blautsauger (Bosnia-Herzegovina): Hairy, with no skeleton, large eyes, it can polymorph itself into a rat or a wolf. It can charm at minus 3. It can only turn its victims into vampires by forcing them to eat earth

from its grave. Those who consume the earth will become vampires when they die, even if not killed by the blautsauger. Only a *wish* will prevent this. Those who die from the blautsauger without eating the earth become spectres. To defeat: Burn its body or stab it through the heart with a stake.

Mulo (Serbia): Men, women, and children wearing white clothes. They love wine. They are active day and night. They can *polymorph* into either horses or sheep. A mulo kills its victims by charming them (minus 2), then putting them into a large pot of boiling water. Blood draining by mulos will put the victim in suspended animation, awaiting the pot. To defeat: Get them drunk and leave quickly, or a cleric must fight them to the death.

Alp (Saxony): A butterfly that attacks day and night. It settles on the chest of a victim and suffocates him. Each alp can call 10-100 ordinary butterflies and can throw one sleep spell per 24 hour period. To defeat: Find the corpse acting as recipient for the butterfly and put a lemon in its mouth. Without the lemon, destroying the body will force the alp to find another body, but not kill it.

Anananngel (Philippines): A flying head with entrails filled with blood after feeding. It charms at minus 2 and can throw a fear spell at minus 3. There is a 50% chance that it is not undead, but a living witch. As such, it will not be turned by a cleric. To defeat: Sever the entrails to starve it or find the body where it sleeps during the day and hammer a stake through its heart. If splattered with blood from this vampire, the victim will have sores and diseases that only a *cure disease* applied daily for two to seven days will cure. The victim will be incapacitated until then.

Krvopijac (Bulgaria): Only one nostril, otherwise like a common vampire. To find its grave, send a virgin on a black foal through the suspected area. Where the foal refuses to go is where it is buried. To defeat: Chain it to its coffin with a rope of wildflowers (may eventually break), or have a magic-user, holding a cross, order the vampire's soul into a bottle of blood and then throw it into a fire.

Ch'ing-Shih (China): Red, staring eyes, pointed nails like claws, long hair, greenish-white skin, a very beautiful woman or handsome man in spite of everything. It can call 3-18 foxes. To defeat: encircle with rice.

Vlkodlak (Serbia): It has a congested face and blood-red skin. It can cause eclipses. Otherwise, it is like a common vampire. It is active day and night. To defeat: cut off its toes and thumbs, drive a spike into its neck, pierce its navel with a stake (not its heart), then burn it, starting the fire with holy candles.

Bruxsa (Portugal): A woman by day, a bird at night, hence it is active even in sunlight. Otherwise, it is like a common vampire. To defeat: same as with common vampire.

Nosferat (Rumania): It appears as a man or a beautiful woman, depending upon the sex of its victim. In can polymorph into a cat, a dog, a beetle, a butterfly, or straw. It can charm, as a butterfly or straw by touch, at minus 2. To defeat: walk around its grave smoking pipeweed.

| Type | Number of Attacks | Damage |
|-------------|-------------------|---|
| common | 1 | 1-10 plus 2 levels |
| asanbosam | 1 bite, 2 claws | 1-6,1-8,1-10/bite plus 2 levels according to size, 1-4/claw |
| burcolakas | 1 | 1-10 plus 2 levels |
| catacano | 1 spit, 1 bite | 1-12/spit, 1-10 plus 2 levels/bite |
| lobishumen | 1 | 1-10 plus 2 levels |
| ekimmu | 1 | 1-10 plus 2 levels |
| blautsauger | 1 | 1-10 plus 2 levels |
| mulo | 1 | 1-6,1-8,1-10 plus 2 levels according to size |
| alp | 1 | 2 life levels |
| anananngel | 1 | 1-12 plus 2 levels |
| krvopijac | 1 | 1-10 plus 2 levels |
| ch'ing-shih | 1 bite, 2 claws | 1-10 plus 2 levels/bite, 1-8/claw |
| vlkodlak | 1-10 plus 2 level | |
| bruxsa | 1 | 1-10 plus 2 levels |
| nosferat | 1 | 1-10 plus 2 levels |

TO SELECT A MYTHOS

by Bob Bledsaw

Every really good campaign in which I have had the pleasure to play or judge in has had one very common trait . . . a well developed mythos. Like many groups, my campaign began by utilizing the Lord Of The Rings as the source of political structure, history, and mythos. This was great for those which had read the books, but limited the new players which were unfamiliar with them. Although this isn't a fatal handicap, it sometimes places disappointing blocks in the path of an otherwise exemplary player-character. As the game developed further, the desire of many players was to adapt non-Tolkien classes into the campaign and distort the mythos beyond rationalization. This caused me to introduce intra-dimensional nexus points into the game. While some purists may flinch at this point, let me state that only the most persistent search ever led to one of the "gates" and even then access was limited at these well-defended points.

At first I viewed this growth as the opportunity to introduce such mythos I found fascinating as a teen: John Carter & Barsoom, Conan, The Arabian Nights, and others. The real fun began when I started to develop completely new mythos for the group (more likely termed a squadron of earth-shakers by this time). I drew heavily upon Greek, Celtic, and Eastern mythologies, molded them to fit my concept of the living legends which might have formed the prehistoric truths behind them, and limited, combined, extrapolated, and restructured their special powers to obtain a unique mythos. In every instance, I sought to introduce a variety of religion and therefore often retained some pure mythologies in the new land. Around this skeleton was shaped the rest of the land beyond the nexus point; political structures, histories, economic system, geography, flora and fauna, monsters, and non-played characters which made this particular world tick were created from my steady diet of fantasy and science fiction over the years. The extra work was well worth the many hours of fun observing the earth-shakers of Middle Earth being out classed by new player-characters which could respond to the challenge of mystery more quickly. While the older players had more sheer power at their disposal, situations often came up where a little knowledge was more dangerous than none and preconditioned responses were a liability.

My personal preference leans toward the designing of a mythos without "reality" restraints. Every judge should select his own mythos with a careful eye toward what his players expect from the campaign. Chivalry & Sorcery, like Beowulf, resonates with a melody which would be ruined by an over-abundance of incongruent monsters from an entirely different mythos. Like any well done fantasy novel, a campaign can lead your players into a uniquely exciting world unlike anything they have ever experienced. I like a clean slate to begin extrapolating upon. Climate, economics, demography, naming, and so forth are then my domain. The players are given the necessary background information to function within the game and the balance becomes a world of discovery.

Like thousands of other fantasy role-playing judges, I have developed many useful tables which assist me in designing these lands based upon different mythos. It is not the towering megalith of work that it at first appears, nor do I wish to imply that you must be able to write a novel to construct one. There are as many ways to begin designing a campaign as there are judges and styles of play dictate the extent or depth of development required to maintain your player's interest and willing suspension of disbelief. Most important is the decision to begin . . . and you begin by selecting a mythos. If you prefer more concrete ground, then you could begin with Empire of the Petal Throne, Metamorphosis Alpha, or the ever popular Lord of the Rings. Gods, Demi-gods, & Heroes and the material published therein is a source of mythos.

A long trip to your local library may be necessary to flesh out the world and supply the flavor of names, mores, and sociological aspects

of everyday life for your adventurers. However, I would hesitate to do it for a group of players inclined to name their characters Injun Joe the Tail-gunner, Bimbo the Bomber, and the like. They wish to play the game on a more basic level and will probably have the same great time if you spend ten minutes in preparation or ten hours. Most players enjoy a well structured campaign which gives them the "feel" of the mythos and permits the orderly progression of a player-character. Imagination stretch a little.

"Realism" in fantasy role gaming has become the scare word to be touted by some "authorities" in the hobby. They have indicated that monsters, demi-gods, and gods created for game systems by extrapolating upon "real" legends is the result of "sloppy" thinking and has no place in well run campaigns unless the constructs are true to mythology. But this depends entirely upon the end goal of the game system and how much territory the rules are intended to cover. Some game systems are purposely written to cover certain time periods and convey a "feel" of that era or period . . . such as Chivalry & Sorcery or (on a much reduced scale) En Garde. Other game systems are intentionally written to cover the constructed mythos of an entirely new fantasy world such as Empire of the Petal Throne, Runequest, Metamorphosis Alpha, or Traveller. These systems are based upon extrapolations of "real" facts, legends, mythologies of all cultural types, combinations of extant ideas reformed into an almost unrecognizable form, and the occasional rare spark of genuine creativity (take it from a designer. . . it's really rare).

What I am trying to say is that you cannot expect to seriously use a game system such as Boothill to play a campaign based on the Conan series, but you could use a game system such as Dungeons & Dragons to play a campaign based upon a Mayan mythos or almost any non-gunpowder mythos. Because the game system is designed to cover many mythos, it will not necessarily give the correct "feel" in all cases and should be modified to suit the campaign by a knowledgeable and experienced campaign judge. Great caution should be exercised when this is done however, or imbalanced play or an aborted campaign can result. Obviously the game system is based on western mythology with a European accent more medieval than not. This should not be viewed as a limit if a campaign based upon a warmer climate, different political system, or mythos is desired.

Last and very quick, since the "authorities" are probably piling wargleweed around my soapbox and lighting torches, a couple of shots at some criticisms leveled at my campaign materials and guidelines. There is nothing "sacrilegious" about introducing gods into a campaign (even if the players might defeat them). I personally would never use voodoo, Jesus Christ, Buddha, Mohammed, or the one and only Devil in my campaign. The gods in my campaign are actually the source of legends, mythologies, and religions which may be far from the true nucleus of fact that began these worshipful exaggerations, distortions, and ill-perceived powers or acts. A halfling possessing some powerful artifact might be worshipped by a large following. The being might not be of the same plane of existence, or merely a time traveller ala *A Connecticut Yankee in King Arthur's Court*.

And the final blast . . . the guideline tables we publish at Judges Guild are not intended to be used religiously, most the time, or even part of the time as the judge runs his campaign. They are very useful for designing, extrapolating, and sparking up a campaign based on Dungeons & Dragons. They represent the best efforts of many intensely involved and active college students and graduates as we literally picked apart, defined, interpreted, researched, expanded upon, and played to dawn (or death) the original Dungeons & Dragons since it was first published. The tables are not to add "realism" to any campaign. They are for the enjoyment and sources of inspiration of active campaign judges. Dat's all folks!

ARMS AND ARMOR OF THE CONQUISTADORES

Michael H. Kluever



Spanish 16th century 7 ring rapier

In the year 1500 the American continent contained only two significant native empires — The Aztecs in Mexico and the Incas in Peru. Both were at their height in power.

In 1518, Hernando Cortez left Hispanola with but 600 men, 17 horses and 10 cannon to conquer the Aztec Empire. When Cortez reviewed his troops at Cozumel, their ranks totaled 508 soldiers including 32 crossbowmen and 13 arquebusiers plus 100 sailors. Later at Tlaxela, they numbered less than 600 of which 40 were cavalry, 80 crossbowmen and arquebusiers.

In 1531, Francisco Pizarro landed at Atahualpa with 180 men, 27 horses and two cannon. After receiving some reinforcements, he marched against the Inca Empire with 62 cavalry and 102 infantry.

Never numbering more than 1000 men, facing heat, disease and an opposing army possessing an overwhelming numerical superiority, both Cortez and Pizarro were able to overthrow and annex these territories to Spain. It was to be a victory that was to last 300 years.

By all odds the invaders should have been destroyed by the natives. In numbers alone the Aztec and Inca Empires could field armies of a dozen times or more in size proportion to the Spaniards. While primitively armed with slings, javelins, bows, wooden clubs and throwing sticks, sheer mass alone should have brought them victory. But when the superstitions surrounding the white gods mounted on horses and wielding instruments of thunder and lightning produced terror among the natives, smallpox brought by the Europeans decimated the ranks of the natives who lacked immunity, and the Spaniards shrewd ability of playing one tribe against the other kept their strengths divided, their allegiances confused it seemed that Spanish victory was not inconceivable. Nevertheless it was the shot and pike tactics of the Spaniards combined with absolute discipline and their impregnable armor that put victory in the Spanish grasp.

The Conquistadore wore considerably less body armor than the Spanish Army twenty-five years earlier. Full suits of armor had been replaced by half suits. These were primarily worn by cavalry and pikemen. The half armor consisted of heavy steel breast and back plates, flatter than those of the previous century and fastened together by leather or metal straps. The breastplate frequently carried an indentation from a bullet fired by the armorer to proof-test the integrity of the piece.

Cavalry occasionally wore lamellar protection for the upper leg area. Pikemen's thighs were hidden behind single or lamellar plate tassets, one hung from each side of the breastplate.

The Arquebusier (musketeer) and crossbowman rarely wore any armor aside from a helmet. His waistcoat had puffed sleeves and padded shoulders containing sufficient padding to resist or at least retard a sword stroke. His breeches were wide, very colorful and short. High leather boots extending to the knees or higher were worn by all troops.

Cortez upon landing found an abundance of cotton in the area. He ordered thickly quilted doublets (jackets) made. These proved effective against Aztec arrows. Quilted cotton armor was also successfully used to protect the horses.

The cavalry and arquebusier's helmet, the Burgonet, was open faced, followed closely the curvature of the head. The high front brim provided maximum visibility while the closed back protected the neck. Ear flaps enclosed the ears and the sides of the head. A high comb across the top of the burgonet from back to brim protected the warrior's head from sharp blows.



Spanish Morion

Pikemen wore a specialized helmet whose origins rest with the Chapel de fer (Kettle Hat) of the fourteenth century. Called a Morion, its oval-shaped sides, high brim front and back were overshadowed by a very high comb across the top of the helmet. The comb, up to four inches high, was sufficient to prevent any cut from penetrating to the skull as well as spread the force of a downward blow. Its oval shape deflected projectiles. The high brim aided visibility but the back bared the neck and lower head. Gorgets provided some protection to these areas as well as the front of the neck.

Swordsmen carried a small round iron shield called a buckler or target. Varying in size, most were about two feet in diameter. A few were oval. Due to their size, they were easily manipulated to protect its holder from sword, axe or club.

The weapons of the Conquistadores consisted primarily of sword, pike, crossbow and arquebus. Personal daggers were common and quite varied.

The basic weapon of the infantry was the pike. Measuring 12 to 18 feet in length, the spearhead was short with long side straps preventing the shaft from being cut. Cortez purchased a number of double headed spears (pikes) tipped with copper. These saw extensive use in the battles that were to follow. It was Spanish custom that one out of every ten or twenty pikemen be armed with a halberd or glaive, which was especially deadly close quarters. A number of these weapons also accompanied the expedition.



16th Century Halberds

The Conquistadore Arquebusier (musketeer) was usually armed with older weapons. These were matchlocks weighing three pounds with a barrel of three feet or more in length. In battle, these were mounted on a forked musket rest. When loaded, a smouldering piece of impregnated fiber called a "match" clipped to the cock swung to ignite the touch powder as the trigger was pulled. The Arquebusier then patiently attempted to hold the aim of his weapon on an opponent until ignition finally occurred.

A bandolier diagonally slung across the Arquebusier's right shoulder carried the essentials necessary to fire the arquebus. In each small bag was a charge of gunpowder. A leather pouch with bullets, a bottle of oil and a bunch of fuses completed the array which hung from the bandolier.

Wet weather and windy days played havoc with the operation of the Arquebus. But when everything was favorable, a musketeer might fire as many as one shot per minute. The accurate range of these weapons was between 100 and 200 yards.

The thunder and fire from the Arquebus was instrumental in breaking the spirit of attacking Aztecs and Incas. More than any other weapon, it contributed to the destruction of the Aztec and Inca Empires.

The crossbow was very popular among the Conquistadores. It supplemented the fire power of the Arquebus possessing a higher rate of fire and a lesser percentage of misfire. The bow portion was made from steel and drawn back either by a cord and pulley device or by a rack-and-pinion mechanism. Heavy to carry, clumsy to handle, unable to function properly in wet weather, it was nevertheless powerful and accurate up to a range of 120 yards.

The projectile fired was called a bolt or quarrel. It was short and squat when compared to the arrow for a long bow. The iron tip was frequently square and the feather leather vanes. When fired at close range, the quarrel was able to penetrate armor.

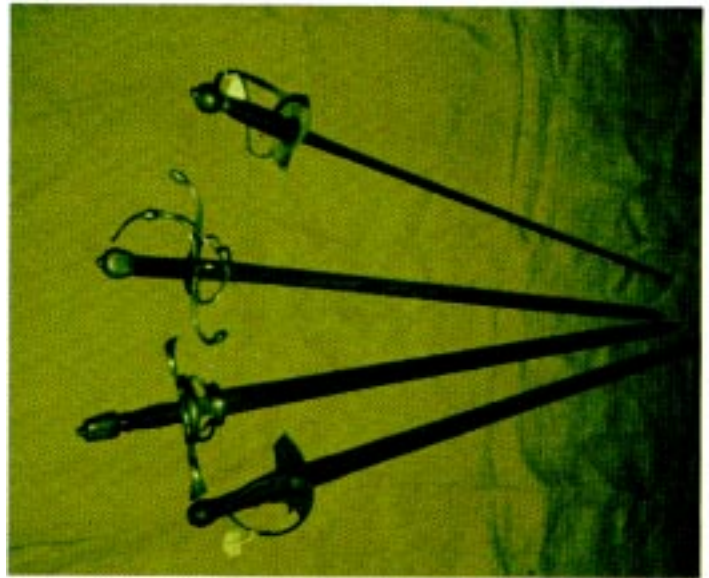

Spanish 16th century swords

Produced at Toledo and Valencia, the Spanish sword was a beautiful weapon common to most soldiers. The ingenuity of the Spanish armorers is seen in the exquisite pattern of curved guards and counter-guards that protected the hand and proved useful in catching the opponent's blade. The rapier blade was narrower than during the previous century, but not the thin fencing blade that was to follow. Having two edges and a point, the Spanish sword was both a cutting and a thrusting weapon.

Prescott in his book, *The Conquest of Mexico*, describes the Spanish sword, "The naked body of the Indian afforded no resistance to the sharp Toledo blade; and with their good swords, the Spanish infantry at length succeeded in staying the human (Aztec) torrent."

The battle formation of the Conquistadores was often similar to those utilized in the European campaigns. Drawn up in a solid column of infantry known as a "battle," the Arquebusiers were at the corners of the battle in as many ranks as possible. After the first rank fired, it withdrew to the rear to reload and on successive volleys moved forward until it was their turn to fire again.

The pikeman's function was to provide protection to the Arquebusiers as they reloaded. Consisting of an overall percentage ranging from 50% to 75% of the battle, they held their ground. Should the enemy's ranks be broken by firepower, the pikemen formed into a line and advanced shoulder to shoulder.

Cortez, when having sufficient numbers, preferred to open the battle with a cavalry charge. At Tacuba, after the charge, the Arquebusiers and crossbowmen opened a lively volley on the Aztec flanks and the infantry armed with swords and pikes and supported by Indian allies destroyed the Aztec center.

In less than a decade, both mighty empires were conquered and were not to taste freedom again for 300 years.

BIBLIOGRAPHY

Bramsen, Stig — *Warriors and Weapons of Early Times*
MacMillian Co., 1972

Diaz, Bernal — *The Bernal Diaz Chronicles*
Doubleday, 1956

Prescott, William H. — *The Conquest of Mexico*
Junior Literary Guild, 1934

Prescott, William H. — *The Conquest of Peru*
Mentor Books, 1961

Warner, Philip — *The Soldier*
Taplinger, 1975

Wilkinson, Frederick — *Arms and Armor*
Grosset and Dunlap, 1973

Over \$500 To Be Awarded At GenCon Wargame Figure Painting Competition

A new competition will be inaugurated at this year's GenCon, scheduled for Aug. 16-19. Sponsored by TSR Periodicals and The Dungeon Hobby Shop, the competition is for painted wargame figures.

Over \$500 in prizes will be awarded in a total of seven categories. The competition will be divided into two size classifications, with each of these further divided by period. The two size classes are *Micro Scale* and *Regular*. Micro Scale is to consist of all micro-sized armor and other types, such as spaceships (Grenadier and Valiant, for example), naval vessels (CinC 1/2400, GHQ *Micronauts*, Valiant *Fighting Sail*, *Superior*, *Waterline*, etc. *i.e.*, any scale smaller than 1/200, inclusive) and airplanes. The Micro Scale class is further divided into two categories: *Unit* and *diorama*. Unit is defined as a militarily definable and recognizable organization. (This definition applies only to this class; unit is defined differently in other categories.) The minimum number of figures in this class is five, and the maximum is forty.

Dioramas are limited only in base size—15" X 15".

The *Regular* class consists of 15mm, 20mm, 25mm, and 30mm figures. This class is further divided into two categories; Historical and Fantasy & Science Fiction. The *Historical* category is further divided into two sub-classes— *Unit* and *Diorama*. The minimum number of figures represented must be a viable unit on the wargame table. Unit size is limited to one battalion of foot or horse, or one battery of cannon or siege equipment. The maximum number of actual figures must be justified by an existing, commercially available set of rules governing the period. Diorama limitations apply as above, 15" X 15", maximum.

The Fantasy & Science Fiction Category is also divided, this time into three sub-classes: *Unit*, *Diorama*, and *Monster*. *Unit* is defined as at least five, but no more than 40, figures in a plausible organization. The diorama restrictions are the same as previous categories. The monster sub-class is limited to five figures or less. (Some may qualify as both Unit and Monster, but may only be entered in one.)

If you wish to enter, you need only show up at the appointed times. There will be a \$1 entry fee per entry. We will provide secure storage prior to the actual judging. You must package your entries for safety from incidental damage — we will provide security and a place to store them in *your packing*. The actual judging period is the only time that all entries will be on full display, and we will do everything we are capable of doing in an effort to protect your property. The results are scheduled (remember that we are talking about an event some six months away) to be announced shortly after lunch on Sat., the 19th. The actual judging will be occurring during lunch. We would like to place the winners on display for the rest of Saturday.

There are a total of seven classes and sub-classes: Micro-Scale Unit; Micro-Scale Diorama, Historical Unit. Historical Diorama, Fantasy & SF Unit, Fantasy & SF Diorama and Fantasy Monster. Each of the seven class winners will receive an engraved plaque and a year's sub to the TSR Periodical of their choice. In addition, there will be two BIG prizes: *Best of Show* and *Sweepstakes Award*. *Best of Show* will go to the best diorama in the entire competition, the *Sweepstakes Award* will go to the best unit entered in the competition. These two awards also merit plaques, along with \$250 in gift certificates. *Best of Show* will receive a \$150 G.C. from the Dungeon Hobby Shop, while the *Sweepstakes Award* merits a \$100 G.C. from The Dungeon, The Dungeon is the most complete wargame hobby shop in the midwest, and also carries an extensive line of trains and equipment, and capable of fulfilling any gamers' dreams. Their mailorder service is extensive and efficient.

Continued from page 34

their explanation of the events which took place. Common sense and logic are certainly the keystones of D&D, and I am appalled to read of the treatment you and your associates received.

If you would care to submit your suggestions regarding a reasonable set of guidelines for running a role playing adventure game tournament, we will certainly be pleased to consider publishing them in DRAGON. If there were more well-done fan magazines, I would suggest that

the subject would be the purview of players, but as I doubt the ability of the current amateur press to handle the subject, I will suggest that Tim Kask take this under advisement for discussion in DRAGON. Perhaps that magazine could eventually publish a set of guidelines for tournament organizers and referees.

I hope that you will be able to attend GenCon this August, for Bob Blake always runs a good D&D tournament for us. Please let us know if we may be of any further service.

E. Gary Gygax

Guidelines to Consider

Reasonable entry fees

Reasonable prizes considering fees

Advertising states party size

- * *single participant*
- * *groups of individuals only*
- * *groups of individuals and teams*
- * *teams only*

Reasonable DM: player ratio

Reasonable time per group

- * *instructions*
- * *organization*
- * *actual play*

Reasonable refereeing, clear, helpful, and

DISINTERESTED

- * *no partiality to players*
- * *no desire to see players fail*

Adequate facilities

- * *space*
- * *noise level*

Prompt starting, with an adherence to time limits

Control of unruly or disruptive players

RULES

- * *book rules as nearly as possible*
- * *all exceptions and interpretations on player instruction sheets*
- * *party characters completely prepared and assigned*
- * *head referee to be final judge in disputes*
- * *all variables averaged in order to reduce luck factors*

*All referees experienced and familiar with the tournament scenario
Wherever possible, two per group (if over five).*

THE INTERNATIONAL DM SEARCH IS ON! AGAIN!

THE DRAGON is compiling a list of DMs to be published sometime in the late fall.

If you wish our list to include your name, simply send it to us on a postcard or 3X5 note card. If you wish to be listed for a game other than D&D please specify. If no game is listed, it will be assumed that it is the one and only— D&D.

THE DRAGON hopes this list will be the biggest ever compiled by anyone anywhere. What easier way to get fresh BLOOD in your campaign? It pays to advertise.

Simply send your cards to:

Mapping the Dungeons
c/o THE DRAGON
POB 110
Lake Geneva, WI 53147
USA

AN ADVENTURE . . .



IN SEARCH OF THE UNKNOWN

A deserted stronghold deep in the wilderness, rumored to contain great treasures of wealth and magic. . . What a promise of adventure and discovery--as well as danger!! This is the setting for TSR's Dungeon Module B1, "In Search of the Unknown".

Created to be an integral part of the DUNGEONS & DRAGONS® Basic Set (but now available separately as well), this module is the first one in this popular series of releases designed specifically for novice players and Dungeon Masters. The module, fully 32 pages in length, contains a complete adventure scenario for DUNGEONS & DRAGONS® which includes descriptive information as well as legend and background material, optional character lists, monster and treasure listings, and two level maps. In addition to the scenario itself, there are additional wide-ranging sections written especially for beginning Dungeon Masters, who can employ the package as a special instructional module to provide insights and ideas for the construction of their own dungeons, as well as benefit from a discussion of how D & D® is best played and enjoyed. Starting players, too, can profit from their own section offering tips on play.

Experienced players and Dungeon Masters will also find the module worthwhile and useful, and a special section gives advice on easy conversion of the game situation for use with ADVANCED DUNGEONS & DRAGONS®

Like the rest of the releases in this series, this module features a cover folder with interior game maps, as well as a booklet giving all necessary game information and descriptions. The folder comes shrink-wrapped, and the price is \$5.49.



THE DUNGEON HOBBY SHOP
772 Main St.
Lake Geneva, WI 53147

Please add \$1.00 to all orders
regardless of size for postage
and handling.

Take a trip with

The Dragon

The Premier Magazine of Fantasy, Swords & Sorcery and Science Fiction

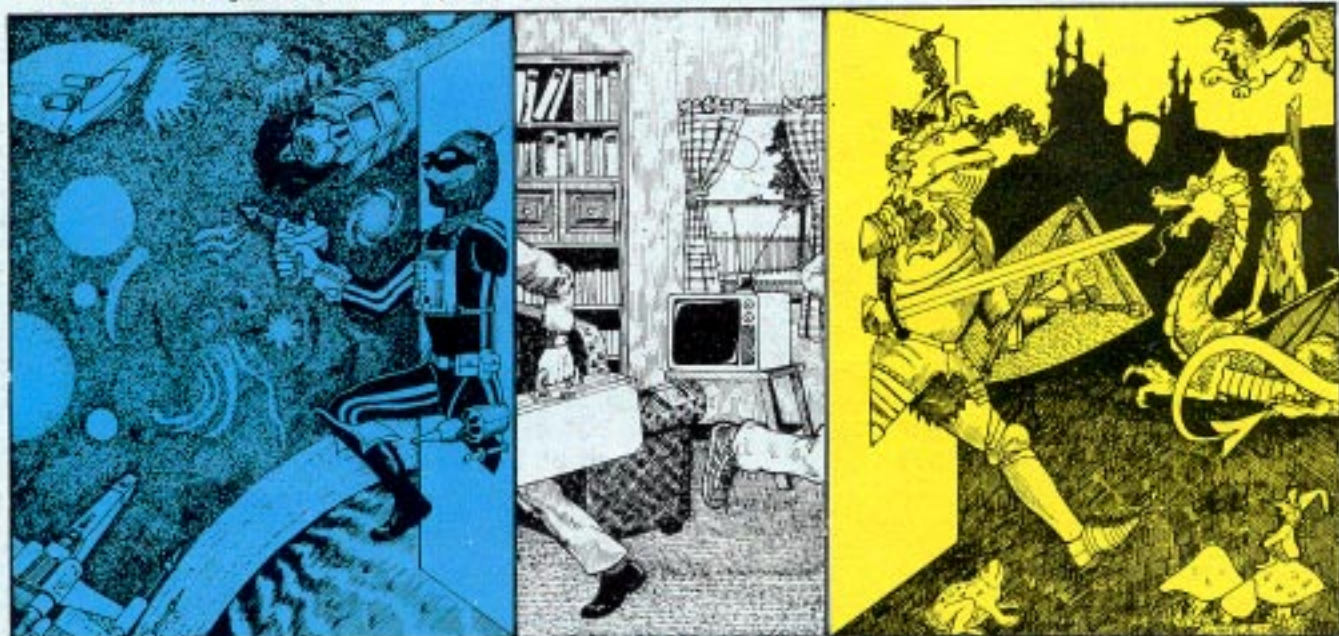

Through the limitless worlds ^{of} your

Imagination

The world is in your mind, awaiting only a key to unlock it. Come along with us on a tour through realms of imagination where magic works or man cruises the cosmos ... Do battle with evil wizards or fearsome beasts ... Explore the universe from the bridge of your F-T-L space cruiser ... Let your mind soar and your spirit exult.

Gardner F. Fox - "Niall of the Far Travels" created especially for The Dragon

Andre Norton - An excerpt from the D&D novel, "Quag Keep".

Fritz Leiber - Fafhrd and the Mouser in "Sea Magic."

Harry O. Fischer - "The Finzer Family".

L. Sprague de Camp and Fletcher Pratt - "The Green Magician." The last saga of Harold Shea. "The Incomplete Enchanter", and more

- D&D articles
- Fantasy game articles
- Satire
- Humor
- Game reviews
- Game Variants
- Comix
- New Figure reviews

THE DRAGON - POB 110 - LAKE GENEVA, WI 53147

Name _____
Address _____
City, State _____
Zip Code _____

☐ \$24.00/13 issues (No. Amer. only)
☐ \$2.00 per issue