

Monthly adventure role-playing aid

Dragon[®]

\$3.50

#112

The Ultimate Article Index
Mesozoic monsters galore
Computer game column



354-74564-7 1B40350

D.B.



DANIEL TORRES HERRERA

CITADEL MINIATURES



Citadel Miniatures are world renowned for quality of design and material. Amongst our award winning ranges you'll find not only our own popular white-metal fantasy models, but also Judge Dredd, Lord of the Rings™, Michael Moorcock's 'Eternal Champion', and Talisman. In fact, the world's largest selection of first class miniatures, every one made by a professional designer for serious hobbyists.

CITADEL COMPENDIUM

The Compendium is Citadel's annual catalogue, featuring a comprehensive selection of the models currently in production. Inside you'll also find articles about painting, modelling and gaming with miniatures, as well as spectacular photos and many other items of interest.

CITADEL JOURNAL

The Journal is Citadel's own irregular magazine, published as an update on the Compendium as and when new models are released. Full Warhammer Battle Rules details are provided for all new ranges, and every Journal features a complete Warhammer scenario. Colour photos, articles on gaming, modelling and painting go together with regular letters column and numerous competitions to make the Journal Britain's most popular (and indeed only!) magazine of its kind.

Only
\$4.00

Only
\$4.00

GAMES WORKSHOP U.S., 8920 ROUTE 108,
COLUMBIA MD 21045, U.S.A.

©1988 Tolkien Enterprises THE HOBBIT™ and THE LORD OF THE RINGS™ and all the characters and places therein are trademark properties of Tolkien Enterprises, a division of Eden Merchandising Inc., Berkeley California. No unauthorized use permitted.

*Metal Miniatures are not toys and are not suitable for children under 12 years of age. They contain lead which may be harmful if swallowed or inhaled.

JUDGE DREDD®
1988 PDC Magazines Ltd
JUDGE DREDD Miniatures are a
Titan Citadel Co-Production



CITADEL
MINIATURES

Rolemaster™

THE CLASSIC FRP SYSTEM FROM IRON CROWN ENTERPRISES, INC.

ROLEMASTER™, a complete Fantasy Role Playing system in one box, is the most detailed, consistent and flexible set of FRP guidelines available.

The ROLEMASTER™ box set includes:

- **SPELL LAW™** – A complete magic system with over 2000 spells for 15 character classes utilizing 3 realms of power.
- **ARMS LAW & CLAW LAW™** – A system with all the elements of realistic armed and unarmed combat including weapons, armor, animals and critical strikes.
- **CHARACTER LAW & CAMPAIGN LAW™** – A comprehensive character generation system along with reference material invaluable to Gamemasters.
- A free **LOREMASTER™** module.

Part of the ROLEMASTER™ system, but sold separately is **CREATURES & TREASURES™**, which details 3 key areas of FRP: creatures, treasures, and random encounters with both.

ROLEMASTER™; use it wholly or in part. It stands alone or adds depth to your current system.

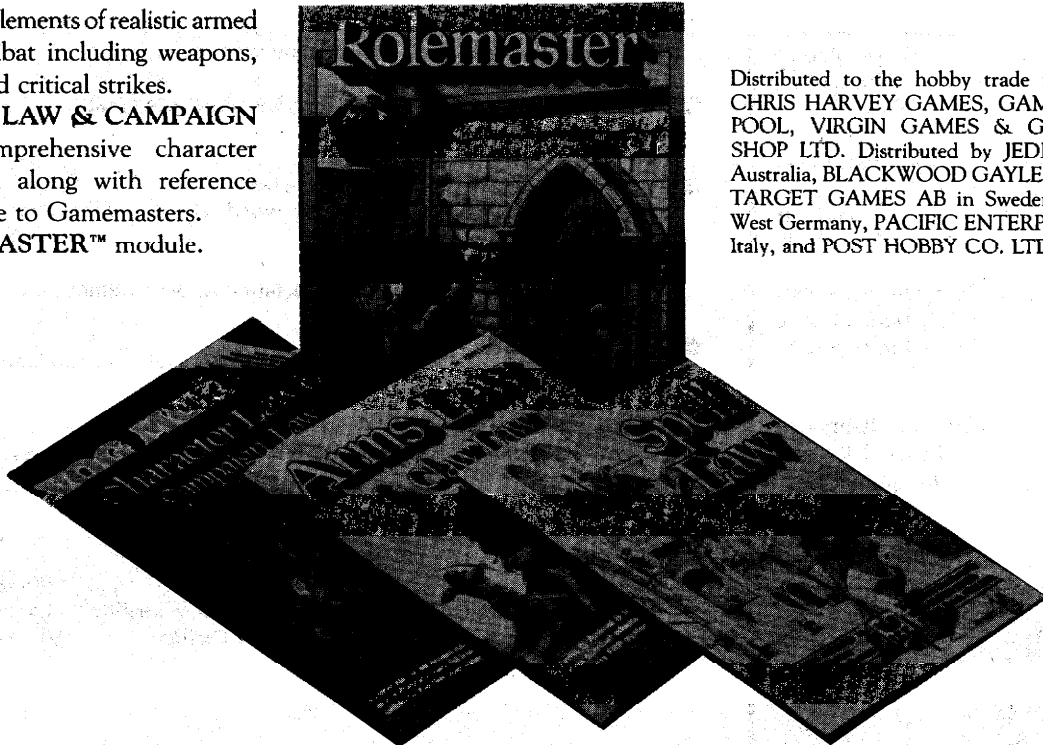

Distributed to the hobby trade in the U.K. by CHRIS HARVEY GAMES, GAMES OF LIVERPOOL, VIRGIN GAMES & GAMES WORKSHOP LTD. Distributed by JEDKO GAMES in Australia, BLACKWOOD GAYLE in New Zealand, TARGET GAMES AB in Sweden, CITADEL in West Germany, PACIFIC ENTERPRISE ITALIA in Italy, and POST HOBBY CO. LTD. in Japan.

ROLEMASTER™ ... a cut above the rest.



IRON CROWN ENTERPRISES / P.O. BOX 1605 / CHARLOTTESVILLE, VA 22902

PLEASE RUSH ME: U.S. \$

- SPELL LAW \$12.00
- ARMS LAW & CLAW LAW \$12.00
- CHARACTER & CAMPAIGN LAW \$12.00
- ROLEMASTER BOX (includes all of the above) \$34.00
- CREATURES & TREASURES ... \$12.00

Orders up to \$49.99 add \$1.25 postage & handling, orders of \$50.00 or more add \$2.50. Canadians add (U.S.) \$2.50 on all orders. Send check or money order, no cash or COD. VISA & MASTERCARD orders call (800) 325-0479. VA residents, Canadians & overseas customers call (804) 295-3917. Send \$1.00 for color catalog.

NAME _____

STREET _____

CITY _____ STATE _____ ZIP _____

PHONE _____

Copyright 1986 IRON CROWN ENTERPRISES, INC.



Publisher
Mike Cook

Editor-in-Chief
Kim Mohan

Editorial staff
Patrick Lucien Price
Roger Moore
Robin Jenkins

Editorial assistance
Eileen Lucas

Art, graphics, production
Roger Raupp
Kim Lindau

Advertising
Mary Parkinson

Subscriptions
Pat Schulz

This issue's contributing artists
Daniel Horne
Jim Holloway
Marvel Bullpen
Dave LaForce
Lawrence Raimonda
Richard Tomasic
Joseph Pillsbury
Bill Cleveland
Larry Elmore
Dave Trampier



Monthly adventure role-playing aid **Dragon**[®]

SPECIAL ATTRACTIONS

- 41 The Ultimate Article Index** — *compiled by Jean Black*
After this, an update is all you'll ever need
- 51 TSR staff GEN CON® Event Listing**
Better late than never — and besides, they're free!

OTHER FEATURES

- 8 Dawn of a new age** — *Kim Mohan*
A fresh look, and outlook, for DRAGON Magazine
- 10 DINOSAURS** — *Steven Inniss*
A monstrous article on the beasts of the Mesozoic Era
- 19 Revenge of the nobodies** — *Joseph R. Ravitts*
When a grass-roots movement grows, watch out!
- 23 The role of computers** — *Hartley and Pattie Lesser*
Our second foray into the world of electronic role-playing games
- 27 Cloaked in magic** — *Ed Greenwood*
Elminster returns with some wise words about windbreakers
- 35 Armor, piece by piece** — *Matt Bandy*
A partial armor system for non-Oriental AD&D® games
- 81 Dire Invasion** — *William Tracy*
Rom™ and the Dire Wraiths™ in the MARVEL SUPER HEROES™ game
- 88 For a Fistful of Credits** — *David "Zeb" Cook*
New equipment for STAR FRONTIERS® gamers

DEPARTMENTS

- | | | |
|-----------------------------|-------------------------------|-----------------------|
| 3 Letters | 38 TSR Previews | 96 Dragonmirth |
| 4 World Gamers Guide | 92 Convention calendar | 98 Snarfquest |
| 6 The forum | 94 Gamers' Guide | 101 Wormy |

COVER

This is probably the first cover painting we've ever published that owes its existence to a real-life experience. As Daniel Horne tells it, "On weekends some of my fellow SCA friends and I go into the countryside in costume. It was late afternoon and we stopped in an apple orchard for a rest. Then we started to sing the song that the dwarves had sung in *The Hobbit*. I looked to the sky and saw ragged scarlet clouds — one of them in the shape of a dragon! I went home and quickly did a sketch of it." Daniel told us the painting is untitled, and suggested we come up with a name for it if we wanted to. Well, "Easy Pickings" seems like an appropriate title, no matter which point of view you consider it from.

Letters

Death of an Arch-Mage's flaws

Kim:

Posted forthwith, a complete (I hope) list of things in "Death of an Arch-Mage" tissue #111) that were botched by me, you, and other responsible parties:

On the ground level map, there should be an opening in the south wall of the inner foyer to connect it to the entrance foyer. And, in the servants' foyer, there should be a door to the kitchen opposite the door in the west wall.

On the upper level map, that long void in the south part between the stairways is the Upper Gallery.

It should be noted on the tournament PCs' sheets that they are all human, and three of them are dual-classed. To be official, the strength scores of Kai Randar and Velton Sectal should each be raised to 15.

Colin Myrrh should also *possess a ring of free action*, and it should be noted that his armor class of 5 does not include *his shield +2*.

The two double-sided documents are the map and the list of guests. All other documents are one-sided, and can simply be photocopied.

Alambar must have a vial of acid in his possession before he can use it.

Flaloch and Fleatis must go upstairs after 9:43 so that they can come downstairs at 9:50.

Otherwise, Kim, we got them all, with the exception of the three typographical errors which I'm certain you'll find.

Michael Selinker
Evanston, Ill.

Your diligence is appreciated, Michael. Considering the complexity and general weirdness of the module, I guess we should be happy that there weren't any mistakes more serious than these. And just for your information, I'm not going to worry a bit about the three typographical errors. (Where are they, you impudent snob? Speak up, or I'll borrow a vial of acid from my friend Alkus and slip it into your mouthwash! Oh, you don't use mouthwash?...) - KM

The case of the missing mimic

Dear Dragon,

Though it may seem rude to correct you, there were a few items in "The House in the Frozen Lands" tissue #110) which I feel need clarification.

Area 11 lists a lesser mimic as being one of the chairs surrounding the tables. Yet nowhere on the map are any tables or chairs. There is also no listing of the mimic's hit points.

In area 49, there is no listing of Oolay'ah's hit points. This could cause problems, as there is a possibility (slim but possible) that a DM could

roll 20 or less for her hit points, and the party could possibly dispatch her by slaying her homonculus. Also, the *Monster Manual* says that a homonculus cannot pass more than 48" (480 feet) away from its master. However, it is entirely possible, using the random encounters table for the labyrinth, for the characters to encounter the creature in area 43. *Shouldn't it be in the same area as Oolay'ah?*

Mike Sostre
Brooklyn, N.Y.

Obviously, we goofed in not showing the tables and chairs (and the mimic) on the map on page 53. However, this is simple enough to fix: Put a couple of square tables in room 11, put four chairs at each table, and pick one of the eight chairs to be the mimic - or let an eight-sided die decide for you. To determine the mimic's hit points, pick up that same eight-sided die and roll it seven more times, or just select a number between 7 and 56 that seems appropriate for the power of the party.

Oolay'ah's missing hit points can't just be rolled up the way the mimic's can be, for the reason that Mike has described. I think it's a good idea to simply give her maximum hit points, to make her as tough as possible. (That's what we would have done if we had noticed the omission in the manuscript before we published the module.)

The homonculus problem isn't a problem at all. According to my ruler, it is possible for Oolay'ah to be in area 49 when the homonculus is in area 43, and the two will still not be more than 480 feet apart as the homonculus dies. -KM

Turning up the volume

Dear Dragon,

I beg to differ with Paul Hancock's otherwise excellent article on "When rations run out" (tissue #107). His note 9 says that "A cubic foot of water . . . is equivalent to one gallon."

Roughly, one cubic foot will hold about 7½ gallons. To carry this farther and out of context with his article, a decanter of endless water employing the geyser function will fill a 10' × 10' × 10' room in just about 25 turns (assuming none of the water is absorbed by the surrounding material or otherwise drains away).

You see, I now have a flooded dungeon with a runaway decanter. . . .

Richard E. Hutson
U.S. Marines in Germany

Right you are, Richard. We could have avoided this mistake by simply double-checking with a table of weights and measures . . . but we didn't. Incidentally, for those of you who use the British system, a cubic foot of water is equivalent to about 6.2gallons. -KM

Half right at the best

If you take this job seriously, as I sometimes do in spite of myself, you can really get hung up on soul-searching. And it's even worse when you ask other people what to do, and they tell you, and you *still* end up searching your soul.

The article on page 8 of this issue is all about some of the things that you have *ordered* us to do as a result of our reader survey. "Deciding" to do those things was easy; as the quotation marks indicate, those weren't really decisions at all - at least, not decisions we had to make alone.

But you people didn't let us off the hook altogether. A lot of the questions we asked aren't being answered by 80% of you one way and by 20% of you the other way. Sometimes the split is more like 70-30, or 60-40 - and in a few cases, it's dangerously close to 50-50. I should have expected this (and I guess I did, if I think about it), but I still don't like it.

I'm tempted to do it, but I won't tell you - for now - what the 50-50 questions are. What I really want to do is gripe a little bit, and lay some advance groundwork for the time when we're going to have to release specific results from the survey and, in so doing, tell you that no matter what we do, approximately half of you aren't going to like it.

The problem is how, or whether, to make a change when half of you want one thing and half of you want the opposite. Unfortunately, we have no way of finding out (except at the expense of time we can't afford) whether we could keep most of you happy by changing "A" but not changing "B" even if you really wanted both "A" and "B" changed.

Would you continue to enjoy (and buy - let's face it; that's what this is all about) this magazine if we didn't change anything? We have to assume that the answer is no; that's why we published the survey, and that's why we are, at least, doing *something* to try to achieve that very elusive goal: the greatest good for the greatest number.

Even now, when we've just begun to take our survey results into account, you can assume that from your point of view, we're going to do something wrong in the issues to come, whether that mistake is the result of action or inaction - if we have'n't done something wrong already. The best we and you can hope for is that we'll acquit ourselves in the long run and you'll be willing to keep spending your well-deserved money on our well-preserved magazine.

The World Gamers Guide

If you live outside the continental United States and Canada, you can be included in the World Gamers Guide by sending your name and full address, plus your gaming preferences, to World Gamers Guide, DRAGON® Magazine, P.O. Box 110, Lake Geneva WI 53147.

Abbreviations in parentheses after a name indicate games in which that person is especially interested: AD = AD&D® game; DD = D&D® game; CC = CALL OF CTHULHU® game; GW = GAMMA WORLD® game;

SF = STAR FRONTIERS® game; ST = STAR TREK®: The Role-Playing Game; MSH = MARVEL SUPER HEROES™ game; TS = TOP SECRET® game; T = TRAVELLER® game; RQ = RUNE-QUEST® game; VV = VILLAINS & VIGILANTES™.

The World Gamers Guide is intended for the benefit of gamers who live outside the continental United States and Canada, in areas where nearby gamers are small in number or nonexistent, as a way for them to contact

other game-players who would be interested in corresponding about the activities that they enjoy. Unfortunately, we cannot extend this service to persons who live in remote areas of the U.S. or Canada, or to U.S. military personnel with APO or FPO addresses. Each eligible name and address that we receive will be published in three consecutive issues of DRAGON® Magazine; to be listed for more than three issues, you must send in another postcard or letter.

Grant I. Fraser (AD,DD,GW)
11 Dallow Place
Henderson Auckland 8
New Zealand

Ho Chung Hsi (DD,AD,SF)
2 Arbuthnot Rd.,
1st floor, front block,
Central District
Hong Kong

Dragons Domain (AD,SF,GW)
56 Woodstock Street
Guildford 2161
N.S.W. Australia

P.J. Juster (AD,DD,T)
30/5 Arbel St.
P.O. Box 326
Karmiel, Israel 20101

Craig Robinson (DD,AD,GW)
P.O. Box 320
Atherton 4883
Queensland, Australia

L. W. Hansen (AD,DD)
B.S. Ingemannsvej 2, Vaer. 74
6400 Sonderborg
Denmark

Tina de Jesus (AD)
30 Mangyan Road
La Vista, Diliman
Quezon City
Philippines

Jeff Johnson
SPDC Ext. Nord
B.P. 31
Maroua
l'Extreme-Nord
Cameroun

Peter S. Magnusson (AD)
Ankarvagen 7
181 43 Lidings
Sweden

Ng Chi Ho (DD,MSH)
Flat F. 12/F
On Lok Garden Mansion
47 Yuet Wah Street
Kwun Tong, Kowloon
Hong Kong

Jeremy Phillips (AD,T,GW)
2 Bryan Ave.
Kilkenny 5009
South Australia
Australia

Winfried Eller (AD,CC,DQ)
Silbegasse 43
6901 Wilhelmsfeld
West Germany

Venezuelan Role-Playing Society
(AD,VV,T)
Avenida Francisco de Miranda
Edificio Galipan, Chacao
Caracas 1060
Venezuela

Gasparini Marco (AD,DD)
Via Galleria No. 2
46028 Suzzara (MN)
Italy

Darren Marsland (DD,T)
P.O. Box 14173
Green Point
8051 Cape Town
Republic of South Africa

Matthew Strickler (AD,DD,TS)
Impasse de Mon Idee 3
1226 Thonex
Switzerland

Bianca Jung (DD,AD,SF)
Neuer Kamp 13
3101 Nienhagen
West Germany

Martin Winstrand
Perstorsv. 1
S-310 70 Torup
Sweden

David Baker (AD,DD)
55-457 Moana St.
Laie HI 96762

Jason Cashill (DD,AD,RQ)
P.O. Box 10962
c/o ARAMCO
Dhahran, Saudi Arabia

DRAGON® Magazine (ISSN 0279-6648) is published monthly by TSR, Inc. The mailing address for all material except subscription orders is DRAGON Magazine, P.O. Box 110, Lake Geneva WI 53147; the business telephone number is (414)248-3625. DRAGON Magazine is available at hobby stores and bookstores throughout the United States and Canada, and through a limited number of overseas outlets. Subscription rates via second-class mail are as follows: \$24 in U.S. funds for 1 year (12 issues) sent to an address in the U.S. or Canada, \$55 for 12 issues sent by surface mail to any other address, and \$95 for 12 issues sent airmail to any other address. Payment in full must accompany all subscription orders. Methods of payment include checks or money orders made payable to TSR, Inc., or charges to valid Mastercard or VISA credit cards. Send subscription orders with payments to: TSR, Inc., P.O. Box 72089, Chicago IL 60690. A limited quantity of back issues are available from the TSR mail order department, P.O. Box 756, Lake Geneva WI 53147. For a copy of the current catalog listing available back issues, write to the mail order department at the above address. The issue of expiration of each subscription is printed on the mailing label for each subscriber's copy of the magazine. Changes of address for the delivery of subscription copies must be received at least six weeks prior to the effective date of the change in order to assure uninterrupted delivery. All material published in DRAGON Magazine becomes the exclusive property of the publisher, unless special arrangements to the contrary are made prior to publication. DRAGON Magazine welcomes unsolicited submissions of written material and artwork; however, no responsibility for such submissions can be assumed by the publisher in any event. Any submission accompanied by a self-addressed, stamped envelope of sufficient size will be returned if it cannot be published.

DRAGON is a registered trademark for the monthly adventure role-playing aid published by TSR, Inc. All rights to the contents of this publication are reserved, and nothing may be reproduced from it in whole or in part without first obtaining permission in writing from the publisher. Copyright ©1986 TSR, Inc. All Rights Reserved.

AD&D, D&D, and STAR FRONTIERS are registered trademarks owned by TSR, Inc. ARES is a trademark owned by TSR, Inc. All Marvel characters and the distinctive likenesses thereof are trademarks of the Marvel Comics Group. MARVEL SUPER HEROES and MARVEL SUPER VILLAINS are trademarks of the Marvel Comics Group. Copyright ©1986 Marvel Comics Group, a division of Cadence Industries Corporation. All Rights Reserved. ROM is a trademark of Parker Brothers. Copyright ©1986 Parker Brothers, Inc. All Rights Reserved.

Second-class postage paid at Lake Geneva, Wis., and additional mailing offices. Postmaster: Send address changes to TSR, Inc., P.O. Box 110, Lake Geneva WI 53147. USPS 318-790, ISSN 0279-6648.

Come play with us.

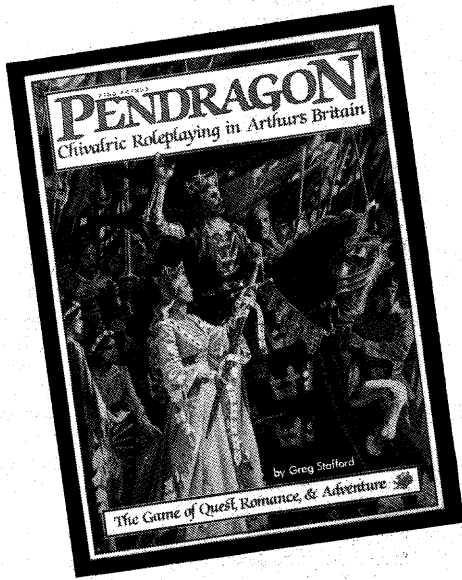

Pendragon
2701-X \$20.00

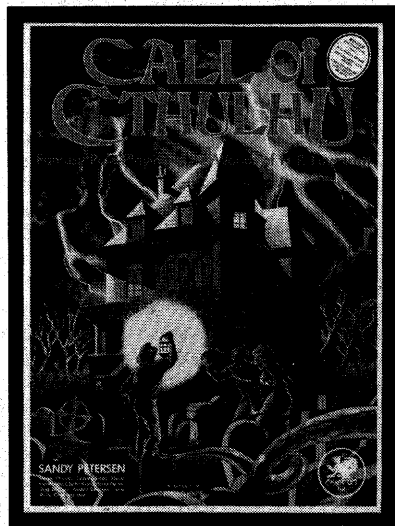

Call of Cthulhu
2301-X \$20.00

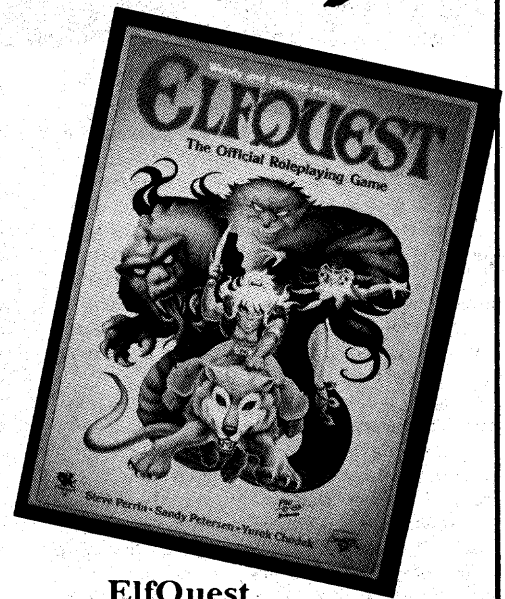

ElfQuest
2601-X \$20.00

We write and publish the finest roleplaying games available. Some of our designs are classics. Other companies like our games so much that they ask us to design some for them.

We know what you like.
Come play with us.

CHAOSIUM CREATIONS:

King Arthur Pendragon

Call of Cthulhu

Thieves' World

Stormbringer

Ringworld

ElfQuest

Hawkmoon
available soon

RuneQuest
from The Avalon Hill Game Company

Ghostbusters Roleplaying
from West End Games

Available at Hobby & Game Stores Everywhere

Chaosium Inc.

Box 6302-D Albany, California 94706-0302

TO ORDER DIRECT BY MAIL: please list game title and product number. Include list price plus \$2.00 for postage and handling. All payments must be in U.S. funds. No COD. Prices subject to change without notice. Allow two to four weeks for delivery.

The forum

"Giant-sized weapons" by Stephen Martin (issue #109) was an excellent piece of writing that goes a long way toward individualizing the many giant-sized, weapon-using humanoids in the AD&D® game. His division of these creatures into groups based on height, weight, and strength was a sound, logical approach to the question. The only minor quibble I have is that Mr. Martin, who was so thorough in differentiating between the various giant-sized humanoids, and even the demi-humans, seems to have overlooked the fact that humans also come in an enormous variety of shapes and sizes.

What Mr. Martin left out of his description of Brute the Barbarian were details such as Brute's height, weight, and strength. A normal-sized human might not be able to wield a stone giant's short sword, but what about one of those Conan clones who seem to inhabit most AD&D campaigns? In the game I am currently participating in, one of the other players has a character named Kraven the Bold, a 10th-level fighter who is 6' 7" tall, weighs 257 lbs., and has a strength of 18/00. When talking about such a mountain of a man as Kraven, I find it hard to agree with Mr. Martin's restriction against humans using any giant-sized weapon that weighs more than 250 gp. The stone giant's short sword weighs only 280 gp, which is only 30 gp more than a two-handed sword; and it shouldn't prove too much of a task to wield it for a character who has a +3,000 gp weight allowance bonus for strength.

What I suggest is that humans be divided into two groups:

Those in Group X are less than 6' 6" tall, or weigh less than 240 lbs., or have a strength of 18/75 at most. Such characters cannot use any weapon weighing more than 250 gp, as Mr. Martin specified for humans of all sorts.

Those in Group Y are more than 6' 6" tall, and weigh at least 240 lbs., and have a strength of at least 18/76. These characters can wield weapons weighing as much as 300 gp, and in addition they receive a +1 modifier to the penalty for using giant-sized weapons. This means that Group Y humans are only -1 (not counting any nonproficiency penalty) on "to hit" and damage rolls when using Group A giant-sized weapons, -2 for Group B, and so on. I base this modifier on the fact that the enormous size and strength of a character such as Kraven should count for something. He may not be able to equal even a gnoll in height or weight, but he is much larger than most humans and as strong as any ogre can be.

James A. Yates
Rockwood, Mich.

Over the years DRAGON® Magazine has published many adaptations of various pantheons, most recently the Nordic (#110). In *Legends & Lore*, the major pantheons of the world were adapted for use in the AD&D® game. It seems that, with the exception of demons and devils, only Judaism, Christianity, and Islam have not become sources for the supernatural milieu of the AD&D game.

This is understandable. Besides the very

pragmatic reasons for not converting the figures of these religions into sets of game statistics, I think it very likely that those connected with the development of the game are themselves adherents of these religions.

But the use of other pantheons to provide elements of the supernatural for the AD&D game is ill-considered. There are a fair number of Hindus, Buddhists, and Shintoists in this country. There are also Native Americans who adhere to the spiritual traditions of their ancestors. Celtic, Nordic, African and other pantheons also have their adherents in the United States, the United Kingdom, and Canada. Using the myths of these pantheons in the game is like claiming they are just stories, or, to put it more bluntly, that those deities don't exist and therefore those religions and traditions are false. The basic issue here is the lack of respect being shown to pagan religions. Whether or not any reader, writer, or editor subscribes to a religion is irrelevant. What is relevant is that the honestly held beliefs of minority religions should not be trivialized in the pursuit of entertainment.

This is not an abstract issue. Since TSR's products are so popular among children and young people, I think it especially important that these products not endorse or tolerate religious intolerance. There is also the point that if these products are going to be introduced into Japan, then now is the time to realize that Shintoism and Buddhism are majority religions there.

The only sure way to avoid insulting or offending anyone's religious sensibilities is to use no one's religion and use only fictional figures generated especially for the game.

Margaret M. Foy
Chicago, Ill.

I appreciate Daniel Thibault's interest in my article, "Agents and A-bombs." About the alpha particle — oops. But I think I was right about U-238. My details are supported by Virginia Brodine's "Radioactive Contamination." The common assumption that U-238 is not dangerous may have to do with the fact that it is almost always found in a dilute form. Mr. Thibault's supplementary information concerning thorium-232 is contradicted by data in "Radioactive Contamination" which assigns thorium an alpha factor of 4 and a gamma factor of 1. It places thorium's biological half-life at 200 years.

Good luck with all hot scenarios.

Thomas M. Kane
Farmington, Me.

After reading Kim Mohan's "Room for improvement" in issue #107, I finally got annoyed enough to write to you people. What annoys me is the "it's realistic" excuse for limiting strength for female characters. Someone needs to lay this excuse to rest once and for all, because there are major flaws in this conception of "reality," the reasoning behind it, and this touting of "realism" over both fairness and playability.

The argument — "it's realistic" — appears reasonable on its face; men are more physically

powerful than women. But the problem with this argument is that it does not encompass the whole of reality. It is a very selective "realism." The game incorporates greater male strength, fails to counterbalance this, so as far as personal attributes go, in "reality" males are superior to females. Any attribute that is favorably biased to the female is deemed too insignificant to bother with, and sexual dimorphism is reduced to a single attribute that greatly benefits the male.

Take Mr. Mohan's belief that women only have a very slight advantage in constitution. But reality does not bear out this contention. The advantage women have in their immune system not only helps them fight disease, it also gives them a significant advantage in resisting wounds by fighting infection. But this little bit of reality does not exist in the AD&D game world — even if a cleric does not immediately cure someone's wounds, such long-term complications do not exist. In fact, the game guarantees that females will die a whole lot quicker than males, by giving them fewer hit points or hit dice. Zero-level human females are especially pathetic when compared to their brothers.

I do not like Mr. Mohan's ideas for incorporating women's "slight" advantage in constitution into the game. Females already suffer worse from disease in the game because so many of them cause the loss of strength points. To allow a female character with an 18 constitution a +1 on the Occurrence and Severity Die Roll is hardly going to add fairness to the game. His suggestion that female magic-users be allowed to throw *permanency* spells without penalty is even worse. In the first place, this does absolutely nothing for the female demi-humans. In the second place, this does nothing for the female human magic-user who is less than 15th level. In the third place, if and when the female human magic-user reaches the necessary level, this ability to indiscriminately throw *permanency* spells could greatly unbalance the game. In the fourth place, the guy that is suffering from all this is the male human magic-user — who is stuck at a maximum of 18 strength just as she is. And in the fifth place, since the loss of the constitution point for throwing *permanency* spells has nothing to do with how good your constitution was to start with, this is not a very realistic way to deal with a good constitution — and I thought realism was supposed to be the point, right?

Another objection I have to the "it's realistic" argument is its application to the demi-human races. How Mr. Mohan concluded that it is realistic to apply the strength limitations to the female demi-humans as well as humans is beyond me. What ever happened to game logic? Aren't elves supposed to be an egalitarian race? How about halflings? Why do the males have an attribute that is superior to the females? If game logic tells us that there is a good deal of sexual dimorphism in dwarves and gnomes, does that make it realistic to make the male of the species superior to the female? These are imaginary races, so squeamishness at giving fair treatment at the expense of "realism" simply does not apply.

But it is not just the to hit bonuses or strength damage bonuses that females lose. They also lose out on ability. The game equates brute strength with fighting skill, so the best female fighter will be stuck at least one level below the best male. That extra level means a better chance to hit through skill, more hit points, one more swing at less than one hit die monsters, and sometimes another weapon proficiency,

(Turn to page 31)

INTRODUCING . . .

VERSION TWO:

DRAGONFIRE

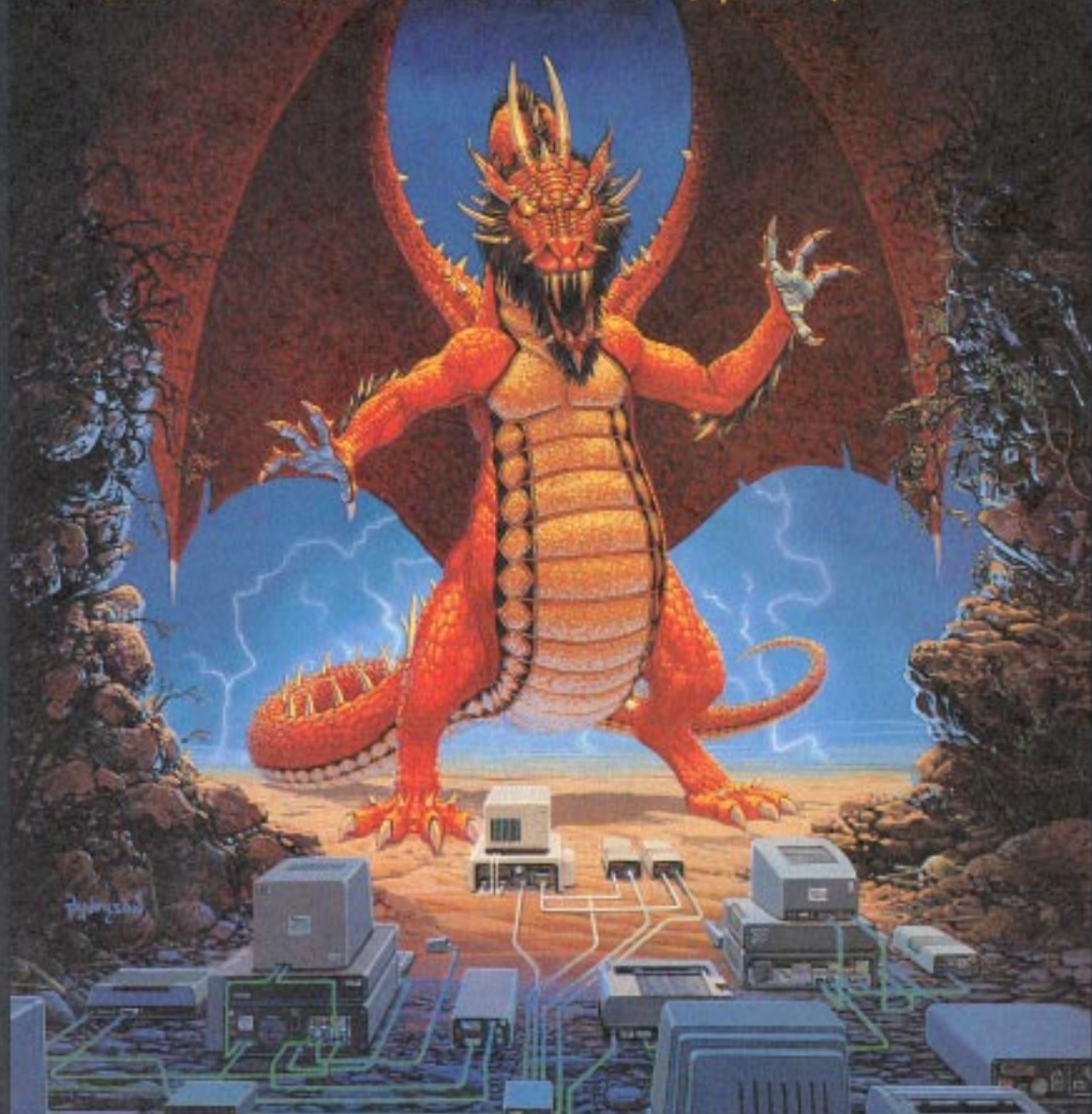

DRAGONFIRE II™: THE DUNGEONMASTER'S ASSISTANT™

Available at quality game and computer stores everywhere.

For information or brochure call: (617) 868-0720
Orders-Call toll free: 1-800-343-0664 ext 6400
(in Mass. call 1-800-322-1238)

Or Send Check or
Money Order to:

Magicware™

P.O. Box 1181 Cambridge MA 02238

DRAGONFIRE II: IBM \$39.95
Commodore & Apple \$34.95

Modules(Require Dragonfire II):

1. Forest of Rith Barradu \$24.95
2. City of Dukarton \$24.95
3. Dungeon Encounters \$24.95

Special: order all three modules for \$60. Add \$3.00 shipping to all orders. Visa, MC, COD accepted.

Dragonfire can be used with most role playing systems.
30 day money back guarantee. Order now!

Dawn of a new age

What we've done and what's to come

by **Kim Mohan**

We asked for it, and we got it.

You asked for it, and now you're going to start getting it.

In issue #107, we gave you a chance to give us your 22 cents' worth. As of this writing (early July), we've received somewhere around \$1,000 worth of advice, heartfelt desires, and insults from our reader survey. (The insults aren't worth as much as the other stuff, but everything counts.) The compilation of all the responses from the survey sheets is not finished, and may not be finished for quite a while; this is the main reason why we aren't putting out a list of statistics along with a bunch of definite pronouncements.

But we know enough from the early findings to take some definite steps that we *know* are in the right direction, and this issue of the magazine is our first real chance to demonstrate to you that the time and effort you spent to fill out and return the survey form was not wasted. Ironically, and perhaps also fittingly, this issue of the magazine contains some good examples of why we aren't always going to be able to give you what you want.

Before we get into the meat of the matter, a couple of definitions and clarifications. First, when we use the word "you," we aren't talking about you the person reading this copy of the magazine; we're talking about *all* of you who read what we print. If you don't like a change we've made, you can assume that you're in the minority; we're going to do things that most of you want, and it should come as no surprise that none of the questions on the survey were answered unanimously. Second, forgive the use of vague terms such as "some" and "most." Like it says above, we aren't ready to stop counting survey forms yet and we aren't going to announce any "hard" figures until that time comes.

SF scaled down

Okay, okay — you don't have to hit us over the head with a laser gun. The most often voiced, and most strongly voiced, opinion of all is that we've been spending too much space on coverage of superhero and science-fiction games. Accordingly, the ARES Section is now a thing of the past. Those of you who wanted us to get rid of

SF material altogether will have to be satisfied with the fact that we're substantially reducing our coverage, and we hope those of you who enjoy SF games will be satisfied with what we are able to do.

From here on out, we'll devote an average of eight pages per issue to science-fiction and superhero games; although those pages won't be set apart in a section of their own, the articles will be run in consecutive blocks of pages and they'll be somewhere in the back of the book (just as they were before). Please don't write in six months from now to inform us that we've only spent an average of 7.1 pages on these kinds of games, or that we've betrayed you by running an average of 9.2 pages per issue; the eight-page figure is a target, not a promise.

Obviously, we aren't going to be able to cover the same number of games with the same frequency in fewer pages. If the first thing you turn to in every issue is the latest MARVEL SUPER HEROES™ article (for instance), then there will be issues when you can turn pages forever and not find one. Our coverage of the SF and superhero games we usually deal with will be as fair and equal as the circumstances, and the quality of manuscript submissions, permit.

A new type of type

The ARES Section may be gone, but a part of its spirit lives on. Because we've always considered the pages in that section to be the most graphically attractive pages in the magazine, we've changed the type style of the rest of the magazine to conform to what was being done on the ARES pages. For typesetting trivia buffs, the name of the typeface is Zapf — and if you hadn't noticed a difference in our page layout before you got this far, you're obviously not a typesetting trivia buff.

In the months to come, we're going to try to put more pizzazz in our article layouts — staying within a consistent framework, but going for as much variety as we can within those boundaries. In addition to making these pages more interesting to read (more on that shortly), we want them to be interesting to *look at*.

Computer coverage

We opened this door a crack in issue #110, when we presented the first install-

ment of a new column devoted to discussions of computer gaming and in-depth reviews of game software that you're probably going to be interested in. You want us to get into coverage of subjects related to computers, and more than anything else you want reviews and information on commercial software. That's exactly what "The role of computers" is intended to provide, and, based on the reaction we've received to the first column, we seem to have done something right.

We're also going to renew and redouble our efforts to obtain other sorts of computer-oriented articles — theoretical articles on how to use the computer to streamline and enhance the playing of a role-playing game, plus listings of programs designed to make a DM's or GM's life a little easier. Our previous efforts in this direction haven't exactly produced marvelous results, to put it mildly — but the greater share of the "credit" for this failure lies with us, and not with the people who've showed us programs. We're going to take it from the top, and this time try to avoid plummeting to the bottom.

Subjects with more spice

You couldn't count on a beholder's eye-stalks the number of times we've sat down in the office and talked about the Big Question: What subjects have yet to be covered, and how do we go about getting articles on those subjects? (well, to be honest, some of those conversations have occurred between yours truly and yours truly — but, then again, I don't know an editor who doesn't talk to himself at least ten times a day.)

You think we're getting stale; you're sick of theoretical articles, "realism" articles, and articles that are nothing more than the trimming around a set of boring statistical tables. (If we ever print another article on falling damage, you're all invited to Lake Geneva to watch me throw myself off the top of the downtown condo.) You want more meat and less mashed potatoes. Okay, we're gonna give it our best shot.

Instead of being quite so particular about what we print, we're going to relax and not worry quite so much about whether an author really knows what he's talking about. We're going to print some

(Turn to page 31)

A GREAT GENERAL CAN WIN ANY WAR.

Gamemaster challenges you to prove it with the greatest battles ever fought from the past to the future! Stalk the battlefields of the Ancient World in Conquest of the Empire.

Dominate the global theatre of

World War II in Axis and Allies.

And now launch yourself into the 21st Century with new Fortress America.

The Scenario: For the first time in history the United States is being invaded.

Deploy bombs, laser complexes and hover tanks to attack or defend U.S. cities and resources.

The Gamemaster Series—

The games you'll play as if your life depended on it.



© 1999 MILTON BRADLEY COMPANY
THE GAMEMASTER SERIES IS A REGISTERED TRADEMARK OF THE MILTON BRADLEY COMPANY, A SUBSIDIARY OF HASBRO, INC.

DINOSAURS



Mesozoic monsters, from the mightiest to the meekest

by Stephen Inniss

The various and numerous beasts of the Mesozoic, “The Age of Dinosaurs,” include some of the most spectacular animals that ever existed. It is not surprising, then, that they have been included in the AD&D® game, which thrives on the spectacular. More than a score of the better-known dinosaurs are included in official works, along with a fair selection of their contemporaries. This is far too many. It is also far too few.

This contradiction has its roots in the fact that while the number of different animals that are listed is high, the number of truly different forms is small. Brachiosaurs or brontosaurus, camarasaurus or cetiosaurs – it’s all very much the same from the point of view of the typical player, since they differ only in their hit dice and the amount of damage they can do. Nor do gorgosaurus, allosaurus, megalosaurus, and tyrannosaurus differ all that much in the nature of the challenge they present. Since they aren’t really all that much different from one another, these monsters could be presented in a more compact manner. Already, they are described according to their genus names in official works (*Tyrannosaurus*, *Triceratops*, etc.). This is like calling all of the big cats (jaguars, lions, tigers, leopards, and the rest) *Panthera* or all dogs and wolves and jackals *Canis*. The same concept can be carried further, as it has been with other entries in the *Monster Manual*. The entries “elephant” and “mastodon” cover more than one genus apiece, for instance, while “shark” covers every sort of predatory shark that there is; the most extreme case, “herd animal,” describes hundreds of different species at a single sweep. Mesozoic animals can be adequately described in a similar way.

If similar forms are ranked together, then the other problem – the lack of variety – becomes more obvious. Official works barely begin to explore the possibilities. After all, the Mesozoic lasted a long, long time. Even though only a fraction of Mesozoic life has been uncovered, and even though only a fraction of it is of interest to typical AD&D game players, that still leaves a great number of animals – hundreds of genera and perhaps thousands of species. Among the missing are most of the small and medium-sized dinosaurs, most of the plesiosaurs and their relatives, the majority of pterosaurs, and the mammal-like reptiles. A keynote of the AD&D game is variety (witness the hundreds of magical items and spells, the numerous combinations of character class and race, and three whole volumes of monsters), and additional creatures mean additional variety, particularly since some of these animal types have unique combinations of abilities and provide new challenges for player characters.

There are other reasons as well for taking a fresh look at Mesozoic animals in the AD&D game. For one thing, the view has grown over the past decade or so that dinosaurs were not just big reptiles. They were biologically comparable to birds or mammals, or at the very least belonged in a category by themselves, unlike other “reptiles.” They may indeed have been warm-blooded, as is indicated by several lines of circumstantial evidence. This makes the animals themselves more useful and interesting and, more importantly, it makes them harder for player characters to tackle, since they now become faster and sometimes even smarter than equivalent giant lizards. With its inclusion of dinosaurs and other prehistoric animals, the AD&D game contains an element of science fiction, in that it uses the findings of the science of paleontology. In science fiction, it’s always a good idea to be up to date, especially if the latest ideas make better stories than the older ones.

Another argument for redefining the Mesozoic monsters in AD&D gaming is that the old information is not only out of date but is occasionally inaccurate. For example, the description of *Tanystropheus* doesn’t correspond that closely to the fossil animal, and neither does the animal listed as *Nothosaurus*. If the game is to include material from paleontology, why not get it right, if only for the sake of consistency? Then, too, there are inconsistencies within the context of the game. *Monoclonius* and *Styracosaurus* are the same size and they are the same sort of animal, but they differ in their hit dice (8 and 10, respectively). Again, *Elasmosaurus* and *Plesiosaurus* are quite similar in form and are given the same lengths (though the *Plesiosaurus* known to paleontologists is a lot smaller than *Elasmosaurus*), yet *Plesiosaurus* gets five more

hit dice. It would be better to keep things in proportion to one another.

Finally, a Mesozoic setting is like any other game setting in that it is more interesting and colorful if it is more complete, and the DM has more detail and background than is available from the game rules. While it is possible to glean material from various popular books, many of them are out of date and none of them were written with DMs in mind. The effort of finding the relevant facts may be greater than it is worth, since creatures from the Age of Dinosaurs can only be part of an ongoing campaign. It is therefore useful to have the information most relevant to an AD&D game campaign readily at hand.

For these reasons, a description and redescription of Mesozoic animals in AD&D game terms is offered here. While it is entirely unofficial and may contradict some official material concerning Mesozoic monsters, it is designed to fit comfortably into the game as a whole.

Categorizing dinosaurs

In describing animals from the Age of Dinosaurs, it is necessary to use large categories, for the reasons mentioned earlier. For the sake of convenience, it is best to use the names provided by scientists who classify these animals. Just which level of classification is used here is a matter of convenience and depends on how much a group of animals varies in its AD&D game characteristics. Typically, the names of orders, suborders, or infraorders of animals are used. This is something like putting elephants, mammoths, mastodons, and related animals under a single name (proboscidean) and including in the description a table that shows how the AD&D game characteristics of the animals vary with size. The space thus saved is used to give a more detailed description of the animals and their habits, and to describe a greater number of different groups.

Despite this space-saving technique, it is impractical to cover all the Mesozoic animals. For the sake of simplicity, aberrant members of a group are left out unless they were common and widespread, in which case they get a separate listing. Small differences within a group are simply glossed over. A great many small or otherwise inoffensive animals are left out, unless they belong to groups that include larger animals and can be conveniently listed under the same heading. Just as the *Monster Manual* doesn’t describe rabbits or songbirds, these listings don’t include animals that are unlikely to interact with typical AD&D game adventurers.

Animals that are incompletely known (say, from a couple of arm bones, jawbones, or teeth) are also left out, since a guess as to the animal’s overall characteristics could turn out to be wrong whenever a more complete specimen is dug up. Besides, many such animals can plausibly be fitted into established groups. Minority groups are discriminated against here; if a type of animal doesn’t have many representatives, then it is usually ignored. Finally, there are animals that are adequately described in official works and are not listed here, except in the encounter tables following the descriptions of the animals (Tables A1, A2, and A3). Despite the above omissions, just about any known Mesozoic land animal that grew bigger than a woodchuck can be found somewhere in the following descriptions.

Mesozoic animals have a number of features in common, summarized here in *Monster Manual* statistics.

% IN LAIR: 5% (*pelagic marine animals* = 0%)

TREASURE TYPE: *Nil*

ALIGNMENT: *Neutral*

MAGIC RESISTANCE: *Standard*

PSIONIC ABILITY: *Nil*

Some general comments apply to these and other standard characteristics.

FREQUENCY: The frequency given is for the animal in its most characteristic habitat; elsewhere, it may be rarer or entirely absent. Larger animals within a classification are usually less com-

mon, but no specific guideline is given since DMs usually choose a level of challenge according to the powers of the player characters encountering the animals.

NUMBER APPEARING: As stated in the *Monster Manual*, this is only a rough guide. This is even more so with extinct animals, though where possible the range given is based on fossil tracks or, failing that, on the behavior of similar modern animals.

ARMOR CLASS: Dinosaurs and mammal-like reptiles are given an armor class like that of a similar mammal or bird, where such comparisons are possible. Some dinosaurs have bony plates under the skin and are therefore better armored than might be expected. Most of the other animals are given the armor class of some equivalent reptilian creature from the *Monster Manual*. For the sake of simplicity, animals are not usually given different armor classes for different body parts, since this would complicate melee and other animals would logically require the same treatment. Again, for the sake of simplicity, armor class does not vary with size. Any advantage a creature gains by being bigger and thicker-skinned is considered to be cancelled by decreased mobility.

MOVE: As with armor classes, movement rates are based on those of comparable animals that have already been defined in AD&D game terms. Within a group, large land animals are often slower than their mid-sized relatives because, although they have a longer stride, their movements are proportionately slower, since a stumble is more serious for a larger animal. In the water, increased size is not so much of a problem, and larger individuals may be faster than smaller ones.

It should be noted that quadrupeds get a larger bonus for outdoor charging movement than humanlike creatures do (page 66, *Dungeon Masters Guide*). This means that a creature with a move of 12" can still catch up with a running human. Like elephants, the larger dinosaurs only *look* slow — a deceptive characteristic that can be used to advantage by the cunning DM. Bipedal dinosaurs should get the charging bonus for a quadrupedal animal, since they are not built like humans and therefore deserve separate consideration.

Terrestrial animals of all sorts swim at their land movement rates, to a maximum of 9", if a swimming rate is not given in the text. Finally, since many of the dinosaur groups became more efficient at moving themselves around over time, a DM may opt to reduce the movement rate of the earliest members of a group by 3" where the group spans the whole of the Mesozoic.

HIT DICE: Dinosaurs and mammal-like reptiles are given the hit dice of birds and mammals of equivalent weight and diet. The more reptilian animals are compared to crocodiles and giant lizards, which (to judge from examples in the *Monster Manual*) are to be granted fewer hit dice pound-for-pound than livelier animals get.

% IN LAIR: The lair varies with the kind of creature and the circumstances under which it is encountered. Marine animals that never come inshore (pelagic marine animals) have no lair. Amphibious forms encountered in the lair are at a hauling-out spot like a place where a seal, penguin, or crocodile spends its shore time. Eggs or very young animals may be found there in season. Terrestrial animals encountered in the lair may be at a daily or nightly resting place, a wallow, or a nest. Archosaurs (see below) and mammal-like reptiles tend nests and nestlings, while the remaining animals described here hide the eggs and leave the offspring to fend for themselves.

TREASURE TYPE: While none of the animals listed here gather treasure, they are not without monetary value in themselves. The hide, horns, feathers, fur, shell, or teeth may have market value. For instance, the tooth of a large carnososaur such as *Tyrannosaurus* might weigh up to 2 lbs., and sell for up to 12 gold pieces (*DMG*, page 27) even if its novelty value is ignored (and carnososaurs

have a lot of teeth!). Horn similar to cow horn might be gathered from the beak or horns of a ceratopsian such as *Triceratops*. Some small dinosaurs may have decorative plumes, while the fur of mammal-like reptiles might also be valuable. Hides of various sorts might also be saleable, and the rapacity of some player characters is such that they might explore other possibilities as well. DMs may wish to curb this looting by considering how the novelty of these materials might be a barrier to their sale.

NUMBER OF ATTACKS: The number of attacks is kept to a minimum where possible, though some account is taken of the tradition that grants AD&D game creatures an attack for each paw, hoof, horn, and tusk. Typically, horned animals are only allowed a single goring attack because the number of horns is quite variable within a group, and because two or three horns aren't demonstrably better than one in combat. Small animals may be given a single attack representing all or part of an attack routine, since rolling dice for tiny amounts of damage can get tedious.

SPECIAL ATTACKS: Large herbivores (those of size L weighing 300 lbs. or more) may trample size S or M creatures, as well as any size L creature of less than half their own weight. A roll "to hit" is made whether the trampling is intentional or accidental, and the damage done depends on the hit dice of the trampler: 2 HD = 1-4 points of damage; 3 HD = 1-6; 4-7 HD = 1-8; 8-11 HD = 2-16; 12-15 HD = 3-24; 16-19 HD = 4-32; and every additional 4 HD equates to an extra 1-8 points of damage.

Trampling can be avoided if the victim has a superior movement rate, but even this might prove impossible if the herbivores are advancing along a broad front. Once hit, a trampled individual may move no farther that round and takes trampling damage from any additional large creatures that pass over the spot and hit the victim (all rolls to hit are at +4, as the victim is considered to be knocked flat). Even the toughest fighter is well advised to stay away from a herd of panicky brontosaurus! Trampling may take place at the end of a charge and may be combined with butting or goring attacks, but not with kicks, bites, and other attack forms.

Some very large carnivores can swallow size S or M prey whole on a successful "to hit" roll of 18 or better. Those who survive the initial biting damage may attack from the inside, but the exposed portions of the innards are well protected (these beasts are *adapted* to swallowing things whole), and the position of the swallowed individual is distinctly awkward, so that the carnivore has the same effective armor class inside as it has outside. The situation gets worse as time goes on. There is a cumulative penalty of -1 "to hit" for each round spent inside.

In addition, all archosaurs (see below), nothosaurs, plesiosaurs, and pliosaurs have a gizzard, which serves to pulverize food before it enters the stomach. The gizzard is hard and muscular, and contains rocks, just like a bird's gizzard. It inflicts damage equal to a bite on each round following ingestion, with no "to hit" roll required. The swallowed individual dies in six rounds from suffocation regardless of other factors, but the body can be recovered (more or less whole) for 1-3 hours thereafter unless the carnivore has a gizzard. If the victim manages to inflict damage for more than one round in a row, the carnivore spits it back up again and can bite again at +4 "to hit" while the prey is still recovering from being regurgitated.

Any large creature may overturn water craft by rising up beneath them, attacking creatures in them, or thrashing about nearby. This applies to habitually aquatic creatures as well as to a tyrannosaur or brontosaurus that happens to be taking a swim. The weight of boat and animal are estimated and compared, and the chance that the water craft capsizes is 10% for each 10% of the boat's weight the animal has. The chance is doubled if the water craft is a canoe without an outrigger. The chance of capsizing is checked each round as appropriate.

SPECIAL DEFENSES: Large animals may be unaffected by poisons, as indicated on page 81 of the *DMG*.

MAGIC RESISTANCE: Note that non-intelligent animals are particularly vulnerable to magical effects, as described on page 79 of the *DMG*.

INTELLIGENCE: Non-intelligent animals range in mental ability from the jellyfish, a colony of brainless polyps, all the way up to tropical fish, frogs, and lizards — a considerable range indeed. Animal intelligence covers everything from the brainiest reptilian animals (such as crocodiles) up to the ability of an herbivorous mammal or bird. Most non-intelligent animals *can* learn from experience, and all the ones described here can show complex behavior such as herding, cooperative hunting, and parental care, though they may be in trouble if they meet situations that don't fit their programmed repertoires. However, these instincts are likely to be quite adequate for dealing with tropical human and demi-human adventurers. Brontosaurus know very well that bothersome small animals should be stepped on or ignored, and if that doesn't work, the brontosaurus should run away. Creatures of animal intelligence are even cannier, and they may even learn to avoid such things as pits and deadfalls if they can detect them.

SIZE: The measure given here is usually the animal's head-to-tail length. Since this may include quite a length of neck and tail (especially in the case of a dinosaur), the animal may not be quite so big overall as might be guessed from the figures given. A 10'-long dinosaur might not weigh any more than a large man, and a 25'-long dinosaur might not be any heavier than a big rhinoceros. Bipedal dinosaurs stand about half as high as they are long, at least when they are on the move, because they lean forward when they walk and stick out the tail behind for balance. They can probably reach heights equal to about three-quarters of their total length. This may turn out to be significant if player characters seek refuge in trees.

Every tenth animal encountered is a juvenile, with 10% to 80%

of its adult hit dice and appropriately reduced attacks and altered movement rates. Smaller and younger individuals are usually nestlings with no effective attack, possibly under parental care, while individuals with over 80% growth are effectively adults.

LEVEL/X.P. VALUE: These figures are not included in the description. Calculating the experience point value of Mesozoic animals is not very time-consuming for the DM, since they have few special abilities. Additionally, a display of the experience-point value for each size and type of creature in the following descriptions would consume a great deal of space. As for the "level" of a Mesozoic monster, any figure derived from the tables in the *DMG* is likely to be deceptive, at least in the case of the larger animals. Since they are not particularly clever, dinosaurs and the like are not as dangerous as, say, demons or elementals that are worth the same number of experience points.

The program and the players

The Mesozoic era is divided into three periods. From earliest to latest, these periods are the Triassic, the Jurassic, and the Cretaceous, each one of which is tens of millions of years long.

Most of the prominent animals from the Mesozoic are archosaurs, which include the dinosaurs and the crocodilians. Birds are descended from archosaurs, and it has even been argued that they *are* archosaurs, albeit of an unusual type. From the middle of the Triassic right up to the end of the Mesozoic era, archosaurs of one sort and another were very common. Of the animals listed here, aetosaurs, phytosaurs, proterosuchians, and pseudosuchians form a group of archosaurs from the Triassic, while crocodilians and pterosaurs are separate groups on their own. The animals known as dinosaurs are from two different groups of archosaurs: the ornithischians (ankylosaurs, ceratopsians, ornithomids, scelido-

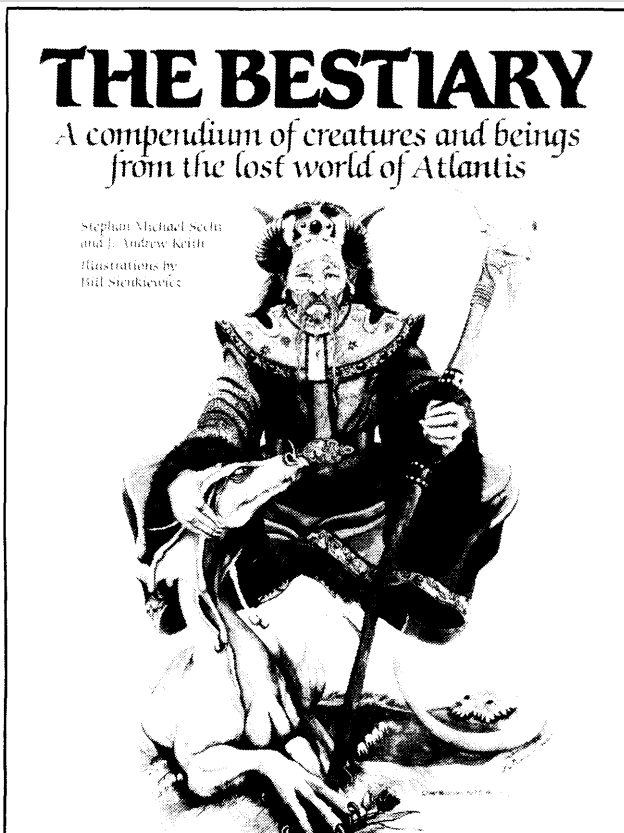

The Bestiary

Encounter the strange and wondrous inhabitants of a bygone age in *THE BESTIARY*, a compendium of creatures and beings from the Lost World of Atlantis. Within the pages of this book, you will meet: the Alicanto, a fabulous bird that feeds on precious metals... the Hantu, so-called "earth-bound demons" of legend... the Ahl-at-Rab, warlike reptilian rulers of the desert sands... the Zazir, diminutive and industrious creators of nature's wonders... and many, many more. Illustrated by Marvel Comics artist Bill Sienkiewicz, *THE BESTIARY* also features a separate section with stats for hundreds of monsters and wild animals, all easily adaptable to the most popular FRP game systems. **\$14.00**

Also available from Bard Games: **The Compleat Fantasy Series, The Lexicon, The Arcanum.**

Available at Waldenbooks, B. Dalton Books, and finer hobby stores in the U.S., Canada, and Australia.

Bard Games
where fantasy becomes reality

saur, and stegosaurs) and the saurischians (carnosaurs, coelurosaurs, deinonychosaurs, ornithomimosaurs, prosauropods, and sauropods). All archosaurs have a gizzard and a four-chambered heart that permits an active mammal-like or birdlike lifestyle. They lay hard-shelled eggs and which they tend and guard in nests. Like crocodiles or birds, they tend the young after hatching time as well, and may even nest in colonies. The eggs are as large as an ostrich egg in the largest species. Small, active, terrestrial archosaurs may have feathers for insulation. Large archosaurs, or those that spend much time in the water, have scaly or warty skin.

The mammal-like reptiles were prominent in the Triassic, and are represented here by cynodonts and dicynodonts. They include the ancestors of the mammals, and they resemble some of the more reptilian mammals such as the platypus and echidna. They suckle their young and may bear fur and whiskers, but they lay leathery eggs which they care for in a nest or carry about in a pouch. They are warm-blooded, if somewhat less active than a mammal or a dinosaur.

Except for the labyrinthodonts, which are amphibians, the rest of the animals described here are more typically reptilian. They are a mixed bag of generally unrelated types and are more fully described in their particular entries.

The animals listed under "Dinosaur" in the *Monster Manual* and its companion volume are shown in Table B with their classification under the new system proposed here. All are accounted for, except for creatures which are not from the Mesozoic and except for *Tanystropheus*. As explained in Table B, the *Tanystropheus* known to paleontologists is much smaller than the one described in *Monster Manual II* and has a somewhat different appearance. Because it is small, aberrant in form, and cannot be included in a larger group, it is not further described here.

In some cases, the suggested number of hit dice for a creature is different from the number given in official works. This is usually because of differing information concerning the size of the beast, but it may also be that the number differs slightly because the hit-dice estimate for the creature fits into a system and must be balanced against the numbers given to similar creatures.

Concerning accuracy

As well as the simplifications already mentioned, there are other alterations of the facts for the sake of clarity. Each period of the Mesozoic lasted a long, long time; saying that a set of creatures lived in the Cretaceous is like saying that humans, three-toed horses, and giant predatory birds all appeared "sometime after the dinosaurs." With such long spans of time, it is convenient to drop out fine details. If a small percentage of a group was present during a period, it is left out entirely, and if the group survived for only part of a period, it is left out as well. On the other hand, any animal that existed in fair numbers through a good part of the Cretaceous is included in the list of Cretaceous beasts, even if it didn't live at exactly the same time as the rest of them. The upper and lower size limits for the members of a group are yet another area of simplification, being less well defined and certain than the precise limits given would imply.

In addition to such simplifications, there are extensions and embellishments of the bare scientific facts. Evidence for such things as skin coverings and behavior patterns is hard to find, but such things may turn out to be important in an AD&D game adventure, so a number of plausible assumptions are passed off as fact. These are usually the speculations of paleontologists, with some basis in fossil evidence, but in some cases the only basis is comparison with animals alive today. Where there is more than one possible interpretation of the evidence, the one that makes the best AD&D game creatures is chosen. The result is not science but science fantasy.

Dinosaur descriptions

AETOSAUR

Aetosaurus are archosaurs from the Triassic. These inoffensive herbivores and omnivores resemble land-going crocodiles in overall form, but the head of each is small and terminates in a blunt, piglike, rooting snout. The back and belly are protected by a layer of armor plating, and there may also be projecting spines around the shoulder and neck. An aetosaur's best defense is to swing its heavy tail at attackers, though it can also bite. Aetosaurus may be treated as terrestrial crocodylians (see below) of up to 6 HD, though they have an armor class of 4 and a bite that does damage like that of a crocodylian two sizes smaller (that is, a 6 HD aetosaur bites for 2-8 points of damage).

ANKYLOSAUR

FREQUENCY: *Uncommon*
 NO. APPEARING: 1-8
 ARMOR CLASS: 2 or 3
 MOVE: 6" or 9"
 HIT DICE: ½ to 11
 NO. OF ATTACKS: 2 (tail)
 DAMAGE/ATTACK: 1-2 to 2-20
 SPECIAL ATTACKS: *Trample*
 SPECIAL DEFENSES: *Nil*
 INTELLIGENCE: *Animal*
 SIZE: *M to L (6' to 35' long)*

Ankylosaurs are ornithischian dinosaurs from the Cretaceous and include such specimens as *Ankylosaurus* and *Paleoscinus*. These browsing herbivores are heavily armored with plates and spikes of bone and horn. They range from goat-sized to elephant-sized. If attacked, an ankylosaur strikes at its tormentors with its massive bony tail. Ankylosaurs vary as follows:

HD:	½	1	2	3	4-6	7-9	10-11
DAMAGE:	1-3	1-4	1-6	2-8	2-12	2-16	2-20
SIZE:	S(6-7) M(8-9) L(10-11)L(12-13)L(14-20)L(21-25)L(26-35)						

There are two major types of ankylosaurs:

Nodosaurids have a solid shell over the back, and have relatively long legs, but their tails lack the mace-like knob found on other ankylosaurs. They move at 9", have an armor class of 2, and inflict damage as if they were one size class smaller (½ HD individuals inflict 1-2 points of damage). *Nodosaurids* typically have long, narrow heads and have long spikes at their sides to prevent carnivores from turning them over.

Ankylosaurids have armor arranged in bands and plates like that of a modern armadillo, and typically lack spines. The legs are short, the body and head low and broad. These beasts move at 6", and have armor class 3. However, the massive knob on the tail makes them very effective in combat.

CARNOSAUR

FREQUENCY: *Uncommon*
 NO. APPEARING: 1-10 or 1-2
 ARMOR CLASS: 5
 MOVE: 22", to 15",
 HIT DICE: 8 to 18
 NO. OF ATTACKS: 3 (claw/claw/bite)
 DAMAGE/ATTACK: 1-4/1-4/3-24 to 0/0/5-50
 SPECIAL ATTACKS: *Swallow whole*
 SPECIAL DEFENSES: *Nil*
 INTELLIGENCE: *Animal*
 SIZE: *L (15' to 40' long)*

Carnosaurs are saurischian dinosaurs and may be found in any period of the Mesozoic. Examples include *Tyrannosaurus* and

New! FOR TRAVELLER®

In science fiction, exotic environments call for exotic inhabitants
In Traveller, we bring those inhabitants to life!

◆ Alien Realms

The Third Imperium, teeming with life and activity, is the source of countless adventures. However, outside the Imperium there exist worlds untouched by human hands. Aliens have shaped these worlds, worlds where exotic adventures can be had—where a completely new type of science fiction adventure prevails.

Alien Realms is an adventure module created especially for the player who has enjoyed the Traveller aliens modules. Eight complete scenarios are presented, with exciting new adventuring material for Zhodani, Aslan, Vargr, and Droyne player characters.

Alien Realms is also presented in a unique new format. Each of the scenarios has both a player's section, packed with information for the players to view, and a referee's section, for his eyes only. Information in the referee's section is organized so that the players might take different approaches to their goal, without bogging the referee down in endless detail.

Alien Realms is intended for use with Traveller. Each separate scenario deals with one alien race, and the appropriate aliens module must be on hand prior to play. \$7.00.



◆ Robots

Aliens you construct yourself! *Robots* presents the long-awaited rules for construction, random generation, and role-playing of androids. The construction process

guides the builder along through all the details of robot design, including locomotion, power plant, sensors, and—that most important element—the robot brain. A history of robots in the Imperium is provided, as is a look at the basic parameters of alien robot design—how those aliens have a different slant on the construction and use of their robots.

Robots continues in the tradition of other Traveller books, like *Mercenary* and *Merchant Prince*, in that it covers a single topic, in this case, robots, in elegant detail, while opening up whole new vistas of adventuring potential! \$6.00.

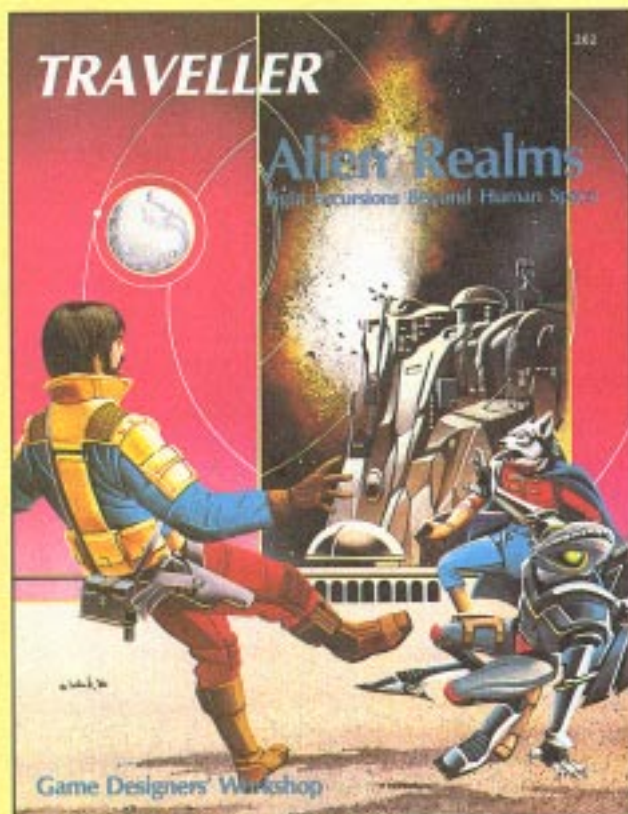

◆ Hivers

Hivers are aliens. They are a cooperative race, but they respect individualism. They live in nests, but can change to another nest any time they want. They abhor violence and war, but they won the only major war they have ever fought. They love their children, but let most of them die before they are a year old.

To understand them, and their place in the Traveller universe, this alien module is essential. This module allows Traveller players to be *Hiver* characters, to play adventures in the Hive Federation, and to learn more about the *Hivers'* culture. *Hivers* have their tentacles far

into the Imperium and beyond—just what are they up to? \$7.00.



GDW Game Designers' Workshop
PO Box 3646, Bloomington, IL 61702-3646

Send for a free catalog.

Ankylosaur

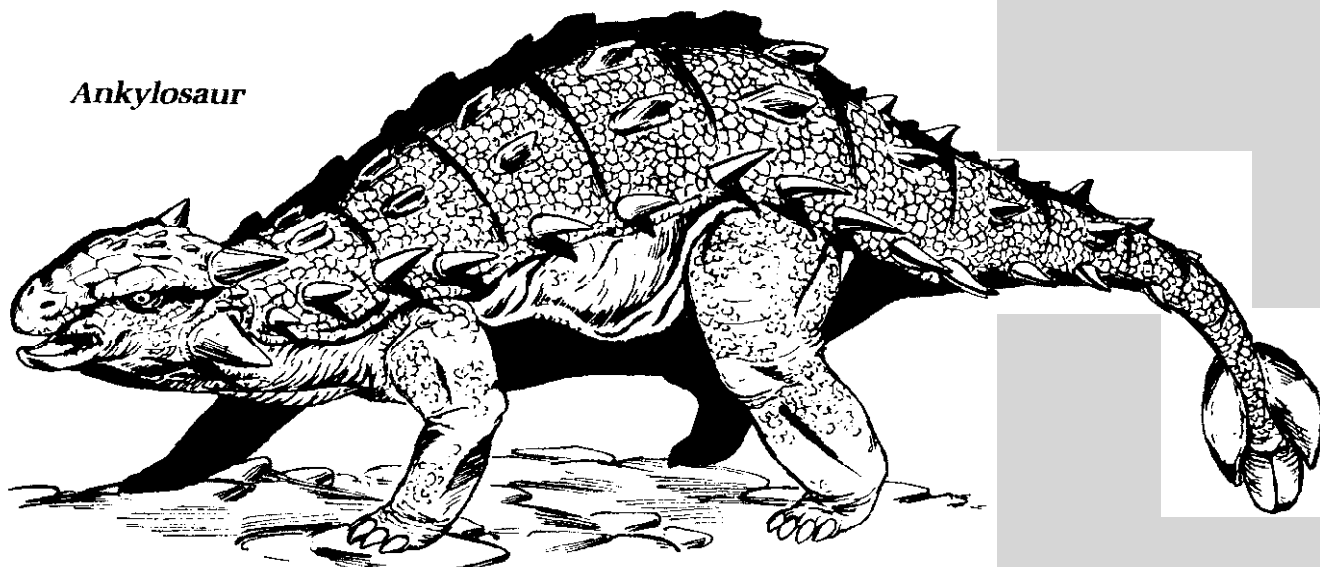

Allosaurus. Carnosaurs may be as small as a grizzly bear or bigger than a bull elephant. They are bipedal, with a large head and a mouthful of sharp teeth, a short but flexible neck, a stout body, a long tail, and powerful hind legs. The arms and front claws are relatively small. Their senses are keen, and very little escapes their attention. Carnosaurs may wade into water in pursuit of prey. They often follow herds of herbivorous dinosaurs, but are always on the lookout for small edible items such as human-sized animals. Carnosaurs vary with size as follows:

MOVE:	15"	15"	12"	12"	12"
HIT DICE:	8-10	11-12	13-14	15-16	17-18
DAMAGE:	1-4/1-4/ 3-24	1-4/1-4/ 3-30	1-3/1-3/ 3-36	1-3/1-3/ 4-40	1-3/1-3/ 4-48
SIZE:	L(15-20)	L(21-25)	L(26-30)	L(31-35)	L(36-40)

The smaller carnosours under 13 HD are swifter and may be found in groups of 1-10, while the larger sorts hunt singly or in pairs. Any carnosaur with 15 HD or more can swallow size S or M prey whole in one bite. Some carnosours have bumps and crests on their heads, and one kind even has a sail-like fin running down its back (perhaps for temperature control), but none of these variations affect combat. A few carnosours (including *Tyrannosaurus*) have arms that are so small and poorly positioned as to be virtually useless, but these are provided with especially large mouths. These bite as if they were one size class larger (17 and 18 HD individuals bite for 5-50 points) but have no effective claw attack. They are called tyrannosaurids, after their most famous member.

CERATOPSIAN

FREQUENCY: *Common*
 NO. APPEARING: 1-100
 ARMOR CLASS: 6
 MOVE: 12" to 18"
 HIT DICE: 1 hp to 12 HD
 NO. OF ATTACKS: 1 (*gore or bite*)
 DAMAGE/ATTACK: Nil to 3-24
 SPECIAL ATTACKS: *Charge, trample*
 SPECIAL DEFENSES: Nil
 INTELLIGENCE: *Animal*
 SIZE: S to L (3' to 30' long)

Ceratopsians are ornithischian dinosaurs from the Cretaceous period, varying in size from as small as a sheep to as big as a mastodon. They crop vegetation with their horny beaks. Examples include *Triceratops* and *Styracosaurus*. A ceratopsian has a huge head, characterized by a bony frill which anchors the powerful neck and jaw muscles and which may only be visible on skulls.

The edges of the frill may be bumpy or spiked, and the head is commonly horned, with up to three different horns (one over each brow and/or one on the nose). Ceratopsians vary with size as follows:

MOVE:	12",	12"	12"	12"	15",
HIT DICE:	1 hp	½	½	1	2
DAMAGE:	Nil	1	1-2	1-4	1-6
SIZE:	S(to 3)	S(4)	M(5)	M(6)	M(7-8)

MOVE:	18",	18"	15"	15",
HIT DICE:	3	4-6	7-9	10-12
DAMAGE:	2-8	2-12	2-16	2-20
SIZE:	L(9-10)	L(11-15)	L(16-20)	L(21-30)

A ceratopsian attacks either with a bite from its massive, powerful beak or a thrust of its horns. In ordinary melee, either attack inflicts the same damage. Hornless ceratopsians can inflict damage equal to a bite on impact if they charge, while those with horns inflict double damage if they charge. Charging ceratopsians have the same armor class as ones in ordinary melee, unlike most other creatures. Ceratopsians vary a great deal in the size and shape of the head-frill and in the placement of the horns, but only the presence or absence of horns affects combat. About 90% of those species with under 3 HD and 10% of those with 3 HD or more are hornless.

CHELONIAN, MARINE

FREQUENCY: *Common*
 NO. APPEARING: 1
 ARMOR CLASS: 3
 MOVE: 3"/18",
 HIT DICE: 1 hp to 7HD
 NO. OF ATTACKS: 1 (*bite*)
 DAMAGE/ATTACK: Nil to 2-8
 SPECIAL ATTACKS: *Capsize boat*
 SPECIAL DEFENSES: *Shell*
 INTELLIGENCE: *Non-*
 SIZE: S to L, (2 to 12' long)

Aquatic chelonians, also known as sea turtles, may be found in Cretaceous settings as well as in modern ones, with the difference that Cretaceous forms may exceed 3 HD in size. Though large, they are inoffensive eaters of sea grasses and jellyfish. Modern leatherback and hawksbill turtles are typical, while *Archelon* is an extremely large Cretaceous form. If attacked, they usually flee; if this fails, they retaliate with a bite. Chelonians that are not attack-



House of Kurita
The Draconis Combine



House of Davion
The Federated Suns

SWEAR YOUR ALLEGIANCE



House of Liao
The Capellan Confederation



House of Marik
The Free Worlds League



House of Steiner
The Lyran Commonwealth

BATTLETECH™

A GAME OF ARMORED COMBAT

In the 30th century, the five major Houses of the Successor States control most everything. In this universe of changing loyalties, you must decide which of these governing bodies you will swear your allegiance. Of course, if being a renegade is your wish, there are always the Bandit Kings of the Periphery, where no law exists except that carried in your holster and exercised through your BattleMech. Join in the fun of the **BattleTech** universe with FASA's line of **BattleTech** games and modules.

AVAILABLE AT BETTER GAME, BOOK, AND
HOBBY STORES THROUGHOUT THE GALAXY

- 1604 **BattleTech** (Basic Set) \$20.00
- 1605 **Black Widow** (Scenario Pack) \$7.00
- 1606 **Fox's Teeth** (Scenario Pack) \$7.00
- 1607 **MechWarrior Role-Playing Game** \$12.00
- 1608 **CityTech** (Advanced Game) \$20.00
- 1609 **AeroTech** (Aerospace Fighter game) \$15.00
- 1610 **BattleTech Mapsets #1** (For use with 1604, 1607, 1608) \$10.00
- 1613 **BattleTech Blueprints Set #1** (Four different blueprint sheets) \$10.00
- 8601 **Decision At Thunder Rift** (Paperback novel) \$3.95
- 8603 **Technical Readout 3025.0** (Sketchbook of Various Mechs) \$9.95

Catalog of FASA products \$1.00 (Free with order)
If ordering direct, include \$2.50 for P & H (\$5.00 for Foreign, Ak, and Hi)

FASA
CORPORATION

FASA Corporation
P.O. Box 6930
Chicago, IL 60680



BattleTech and the above **BattleTech** products are trademarks of the FASA Corporation. © 1986.

The
**Wizards
Nook**[®]

Summer 1986 Catalogue

Is Now Available
Featuring Original
Fantasy Sculpture
Art Prints &

Send \$2.00

(and deduct it from your 1st order) Co.

Post Office Box 16085 Plantation Florida 33318



Revenge of the Nobodies

Peasants can have strength — in numbers!

by Joseph R. Ravitts

At the close of the classic fantasy novel *The Worm Ouroboros*, when the “Demons” (actually human and good-aligned, despite their name) have destroyed all the bad guys, they find themselves stricken with boredom. As a remedy, their gods bring all the villains back to life so that the heroes will have someone to fight. The author, however, gives no hint of how the common people of Demonland felt about this, I cannot imagine that they would be thrilled, especially since no offer was made for resurrection of the rank-and-file casualties on the side of good.

Many heroic fantasies display similar disregard for the welfare and feelings of the story-world’s civilian population, and so do many fantasy campaigns. Even players trying in earnest to portray good-aligned characters may fail to extend their charity beyond the circle of other adventuring characters. The cleric cures every disease of members of his party, but never inquires whether the local village has any gravely ill children. A character owning a *spade of colossal excavation* uses it for military engineering purposes and unearthing buried treasure, but never digs a well or an irrigation ditch.

The common folk, of course, will never complain about this unless the DM wants them to, but if the DM knows enough real-world history, he knows that a large number of disgruntled peasants can create not only a one-time riot, but a lasting political force. Numbers, determination, and stealth can offset to some extent a lack of the conventional means to wage war or exert social pressure.

Below are offered some examples of political movements that could arise among the zero-level masses in a D&D® or AD&D® game campaign. I have not included explicitly religious movements, as these would normally have clerics to lead them. These examples could be initiated and maintained entirely by non-adventuring NPCs, their weapons including work stoppages, theft, and arson. Only if the real or alleged grievance is extreme or the opposition formidable should the DM allow the malcontents the aid of anyone with special powers; even then, it should be someone outside the establish-

ment of adventuring characters. (One faction member, for instance, could be a woodcutter who survived being bitten by a wereboar, lived to master his own ensuing lycanthropy, and now is available to fight for the cause in beast-form, his loyalty preserved by family ties.)

These rebel movements will sometimes be in the right, sometimes not. Either way, they should provide an interesting wild card amid the usual struggles of dynasties, aristocracies, and mighty spell-casters.

The Share-The-Health Movement

Some adventurers (especially in Monty Haul campaigns) enjoy such easy access to *cure* spells that they never have to experience a normal recuperation from wounds or disease. This privilege may even extend to a dozen successive *resurrections* or *regenerations* for a single frequently slain character. Since rank does have its privileges, commoners in a campaign may not resent the hero’s favored treatment by clerics — particularly if any of his injuries, ailments, or deaths were incurred in the defense of the community. If, however, the adventurer always got hurt or killed while pursuing selfish gain, many noncombatants would come to think him unworthy of repeated attention, when constructive members of the community are left to take their chances with wounds and sickness.

A Share-the-Health Movement would begin with peaceful petitioning of the local clerics to adopt an egalitarian policy in the use of such spells as *cure disease*, *raise dead*, etc. At weekly intervals (more often if healing resources were plentiful in the area), there could be a random drawing of names of the ailing and the freshly deceased. A committee could also be formed to judge which persons were worthy of supernatural help, with at least one member of the Share-the-Health Movement sitting on the committee.

If no such reform were instituted (or if it was in use but deteriorated through bribery or favoritism), the protesters could try many forms of retaliation. They might kidnap the uncooperative clerics, if possible. Failing that, they might refuse to worship at these clerics’ temples. The too-often *cured* adventurers could suffer social ostracism (if of low enough birth to be affected by this) or even mob assault. The best of all solutions, though, would be

for members of the movement to become clerics themselves, their training paid for by hundreds of donors in return for their oath to minister to the common people’s needs without profiteering.

The Mines For Men Society

Any number of ethnic-resentment situations from real-world history can be re-fleeted in this scenario. The premise here is that, somewhere in the game world, there is an area whose economy depends on mining. All the local residents are human, but for some reason the mine owners decide to hire dwarves from the nearest dwarf kingdom to work the mines.

The reaction of the furious human miners would be nothing startlingly unusual — a thousand real-world labor crises could provide models — but the ripple effects of a Mines For Men Society, in a fantasy world, should be quite interesting. Suppose, for instance, that the protesters are so ignorant of non-human races that they attack some gnomes in the belief that they are dwarves, causing gnomes and dwarves to unite in self-defense. There might also be evildoers who add to the fray and confusion by murdering some dwarves, intending to have the blame fall on the Mines For Men Society.

The Plain Sight Patrol

Players may find it amusing to imagine their characters using *invisibility* to spy on ladies in their bedrooms — but the fathers and husbands of the women, to say nothing of the women themselves, could be pardoned for considering this behavior offensive. A movement against the abuse of *invisibility*, unlike the previous two examples, could easily gain the support of persons from the middle and upper social classes.

By the very nature of the problem, a Plain Sight Patrol would know the difficulty of identifying and prosecuting the offenders; it would consequently concentrate on defensive and deterrent measures (though some of these could lead to identification of an overconfident *invisible* prowler). Homes and other places guarded by the Patrol would be surrounded by scatterings of sand or sawdust, over which no one could walk without leaving conspicuous footprints. Sentry dogs would be trained to give an alarm whenever they

When it comes to dungeon design, we have a lot to offer

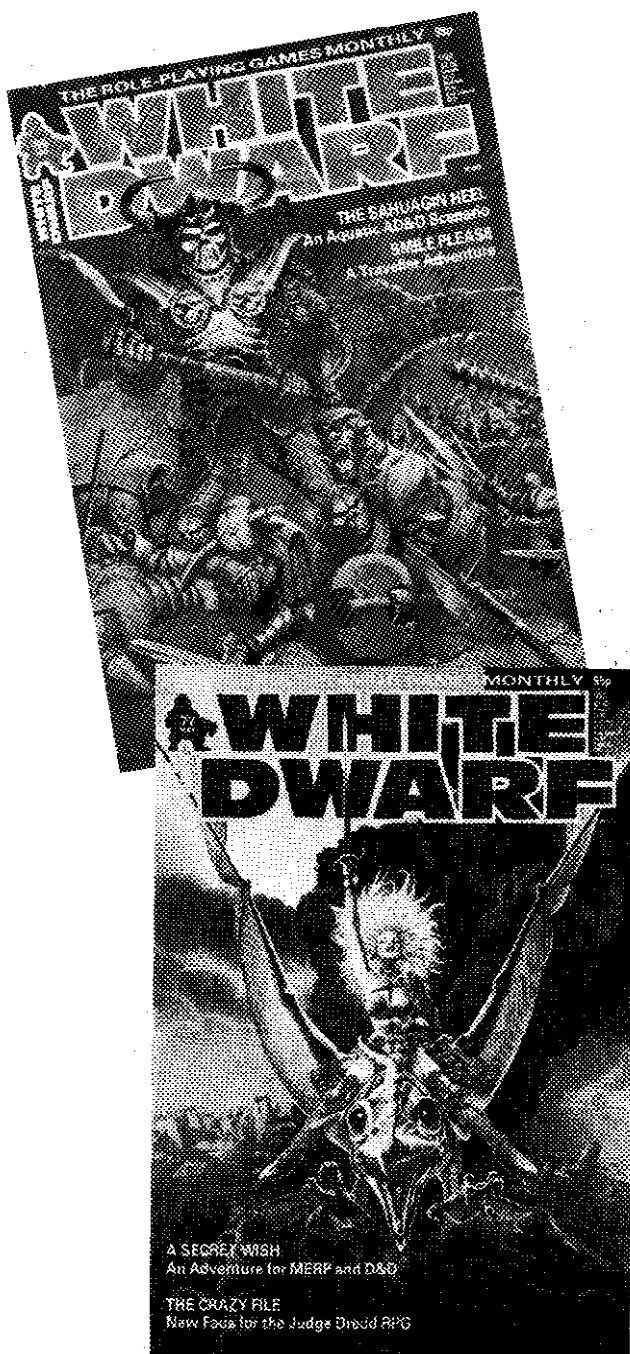

We've been building castles in Britain for over 900 years. The country is steeped in legend, myth, and history. It is not surprising, therefore, that scenarios in **WHITE DWARF** are praised for their realistic atmosphere and content. And it is hardly surprising that **WHITE DWARF** wins so many awards. **WHITE DWARF** is the leading British magazine dedicated to role-playing games such as **Advanced Dungeons & Dragons**®* fantasy adventure game, **Runequest**®, **Warhammer**, and **Traveller**®. Each month it features articles, scenarios, reviews of miniatures and games, letters, and our own comic characters Thrud the Barbarian and Gobbledigook. The increasing demand has enabled us to realize significant savings on production costs. We are passing these savings on to YOU!

NOW ONLY
\$1.95

Place an order today at your local game store, or send \$18.00 for a 12 month subscription—a fantastic saving of almost 25% off the cover price. Write to: **Games Workshop (US), 8920 Route 108, Columbia, MD 21045.**

*Advanced Dungeons & Dragons® is a registered trademark of TSR, Inc. RuneQuest® is a registered trademark of Chaosium Inc. Traveller® is a registered trademark of Games Designers' Workshop.

smelled a body scent from a place where they could not see anyone. Human Patrol members would practice hurling paint and other liquids that would stick to an offender and render him visible.

The Supernatural Sanitation League

To the best of my knowledge, no one has speculated on the possibly unusual excretory functions of fantasy creatures. This distasteful subject is easy for players to avoid, but characters *within* the game world will surely be affected by it, especially in a campaign where adventurers frequently tame or subdue monsters.

If some high-level lord rides into town on the back of his pet copper dragon, will his acid-breathing steed leave behind corrosive droppings that eat foot-deep holes into the pavement? Or, if he has a rust monster on a leash, even if it is kept from eating the townsfolk's metal tools, will the rust monster's droppings destroy the shovel of a street-sweeper who cleans up after it? Could it be that blink dogs, as an instinctive defense against being tracked, can make their body wastes materialize some distance away? (If so, a tame blink dog walking down the street might cause a sudden mess inside a nearby house.)

A popular movement calling for the end of such monstrous contamination is very plausible in any city where captive monsters use public thoroughfares. Even if such special problems as suggested above are ruled out, there would still be unrest — if the monsters are allowed to fly over the city!

The Dumb Animals Controversy

Here is a case not of one united plebeian group revolting against the adventuring aristocracy, but of the plebeians being divided among themselves over whether they approve of one type of adventurers' activity: *speaking with animals*. Common people could find many reasons to react either way to having their domestic animals or nearby wild ones communicated with.

In C.S. Lewis's novel *The Magician's Nephew*, when a cab-horse is given the power of speech, his owner is fascinated but also has to deal with the horse's complaints about being made to work. It could easily be unsettling to receive back-talk from animals we use for our own benefit. Yet the knowledge that could be gained from communication with beasts would, for some, outweigh the uncomfortable psychological effects.

A community debate over letting adventurers converse with local animals would be enlivened if some of the animals themselves could give *their* views on the matter. (Of course, whoever used a *Speak with Animals* spell or spell-like ability to bring out these testimonies might be accused by some humans of passing on a false translation.) If nothing else came of the controversy, it would probably produce more

vegetarians, or at least abstainers from the flesh of the more intelligent beasts.

The Magic Materials Moratorium

Campaigns vary in the emphasis they place on material components for spell-casting, but in any campaign that does enforce the need for such components, magic-users and illusionists who lord it over the populace have a weak spot just waiting to be exploited. If the commoners learn about some of the objects needed for spell-casting (disregarding items too rare for peasants to possess or locate), a concerted effort could be made to steal, hoard, or destroy all such items, making some spells almost impossible to cast.

Naturally, this effort has the most chance of succeeding if the tyrannical spell-casters can be kept unaware of it for a long time. That may sound hopeless — but consider how often great wizards hold zero-level NPCs in contempt, assuming that the latter are too stupid even to know what materials are needed for spells. Although it would never be possible to shut off the supply of *all* spell materials, a determined and secret conspiracy, given time, could end up surprising the spell-casters with enough of a components embargo to cause serious difficulty in magic-use.

The mages and illusionists might still have enough intact resources to try breaking the embargo by force, but a divide-and-conquer effect could occur which would help the dissidents. That is, one or more spell-casters might decide to make allies of the material snatchers instead of attacking them. The spell-caster who thought of this quickly enough could secure a near-total monopoly on some spell components, and thus an advantage over rival spell-casters who hadn't seen the value of befriending the peasants.

The Halflings' Hygiene Backlash

Grass-roots unrest does not always arise because of cruelty or callousness from the powerful. It can also be set off by authorities whose actions are entirely benevolent in motive, but who are seen as unreasonable meddlers. One setting in which this unfortunate phenomenon could occur would be a community in which halflings coexisted with humans, the rulers belonging to the human race.

I have never seen a pronouncement on whether halflings in a game world are susceptible to ringworm infestation and other health problems associated with bare feet. Whether or not they are, human authorities would very likely assume them to be so. With the kindest of intentions, then, these authorities would attempt, by law or at least by persuasion, to make the halflings wear shoes.

The halflings, of course, would resent this. Since resentment easily bursts the barriers of rationality, they might attribute the most outlandishly wicked motives to the well-meaning rulers. Halflings with

any degree of thieving ability would see it as poetic justice to go about stealing as many shoes as possible from humans, making *them* go barefoot. There might even be a campaign of vandalism against cobblers' shops (for businessmen always make convenient scapegoats, and the angry halflings might suspect the shoemakers of instigating the shoe-requirement policy for obvious reasons).

As in the case of the Mines For Men Society, this would be an ideal opportunity for malicious interference by beings hostile to both of the races principally concerned.

The Spirit of Lysistrata

Whether or not a campaign has any ties to the Greek mythos, it could easily accommodate a re-enactment of the Greek legend of Lysistrata, the woman who led a women's revolt to stop a war between rival city-states. The women refused to have anything to do with their men until all fighting stopped. A similar peace movement in a fantasy world might be encouraged by female beings such as sylphs and dryads.

The result of a women's love-embargo would depend on the moral alignment of the nations whose conflict the women were protesting. If both nations were good-aligned, fighting over a mere misunderstanding, there would be a good chance of peace being achieved. If both

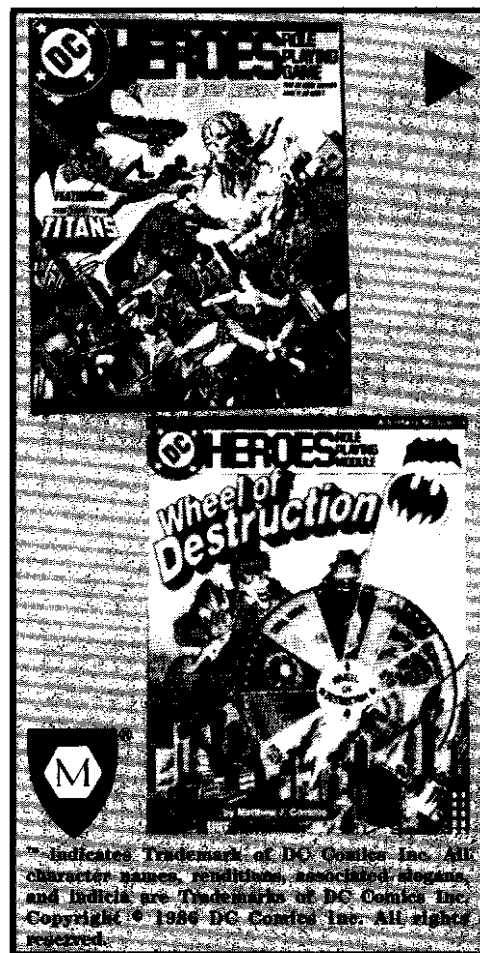

™ Indicates Trademark of DC Comics, Inc. All Character names, renditions, associated slogans, and indicia are Trademarks of DC Comics, Inc. Copyright © 1984 DC Comics, Inc. All rights reserved.

USE SOME MAGIC

DRAGONBONE



Electronic D3,
D4, D6, D8, D10,
D12, D20, D%
Dice Wand

Comes in Charcoal,
Bone or Blood
colors

\$24.95 +\$1.00
S&H

DRAGONSKIN

Protective Book Covers \$3.50 +.50 S&H
(Fits 11" x 8" Rule Books)

Textured Charcoal-colored vinyl



FIGHTER



DRUID



CLERIC



THIEF



UNICORN



GRIM REAPER



MAGIC USER



DRAGON



AMAZON



ILLUSIONIST



SYMBOL OF CHAOS



DRAGON

To order call:
1-800-228-5287

In Illinois:
312-257-9010

A LOW 4 WEEKS DELIVERY



COD

Or mail check or
money order to:

DBE Inc.

25 Sunhill Ln.
Lemont, Ill. 60439

sides were evil-aligned, they would simply force their women into submission — or, if the women had the means to prevent this, the fighters would ignore them and continue their war to a finish, reckoning that the winning side could help itself to the women from the losing side. If it were a good nation fighting an evil nation, their differing responses to the women's protest would result in an automatic, and possibly decisive, advantage for the evil nation. If the good nation managed to win anyway, there might follow a voluntary mass exodus of women from the evil country to the good one, and the women who had tried to browbeat the heroes into surrendering could find themselves out in the cold.

The Youth For All Movement

If, in the real world, people find it easier to allege an evil conspiracy than to accept unwelcome facts of life, all the easier to do so in a D&D world — where so many things *are* caused by evil conspiracies!

One of the least welcome facts of life is aging. A human community having periodic contact with such long-lived races as elves could scarcely help feeling envious. To envy, add the ignorance of the peasantry, and you can get a lot of people convincing themselves that the other race's longevity is an artificial accomplishment that could be shared with humanity if the other race were willing. Better-

educated humans trying to correct this error would be shouted down, accused of "selling out." If even one person in the vicinity were known to possess a *potion of longevity*, this would be viewed as the final proof that all superhuman lifespans were artificially produced.

The tactics of a Youth For All Movement might amount to no more than ordinary protesting and demonstrating, trying to shame or intimidate the elves or other long-lived beings into giving up the supposed secret of extended youth. A sufficient degree of delusion, though, could produce truly bizarre actions, e.g., someone with no real magical training experimenting to create his own youth potion. This would take a sinister turn if the self-styled alchemist got the idea that the blood of an elf was the missing ingredient for his formula. . . .

Summing it up

The use of these political movements in a game world will induce player characters, and the players behind them, to stop sailing along in an elitist atmosphere and give some thought to social responsibility. At the same time, if the protest movements are well handled by the DM, it will be seen that there is a self-righteousness of the lower classes as well as of the upper, and that evil may arise from either extreme.

Finally, thinking purely in game-playing terms, the existence of these malcontent factions will provide a potential source of biographical background for adventurers. Players often fail to decide what their characters were doing before they achieved the qualifications to be first-level adventurers. But, for some characters (especially fighters and thieves), it can be said that they first took up adventuring because their civilian life became dominated by involvement in a cause. This will produce allegiances and animosities that may follow a character throughout his or her career. This kind of personality development does every bit as much as new monsters and new spells to keep life in a fantasy campaign. U

Label your letter

The address of DRAGON® Magazine is P.O. Box 110, Lake Geneva WI 53147, and that's all you need to make sure your letter gets here. But you can help us serve you more quickly by adding a line at the top of the address to tell us what department should receive your letter or package. Call it a "manuscript submission," "cartoon submission," "query letter," or any other short phrase that tells us what's inside, and it'll get exactly where it's supposed to go.

STATE OF WAR

The year is 2000! They said it would never happen again. BUT IT HAS!!!
CIVIL WAR IN THE U.S.!!!

After years of foreign wars and inept leadership, twenty states attempt SECESSION in this newest Play-By-Mail game from the PBM leader, Game Systems Inc. As the GOVERNOR of the state of your choice, you must order the recruitment and placement of troops, allocate expenditures for training, industrial expansion and scientific research, and still try to keep your populace happy! With CSI's NEW "Phase" system, players can give from 50 to 100 orders per turn and receive combat results on MULTIPLE BATTLES per turn! Add this to CSI's reputation for accurate results and prompt turnaround times and you have the BEST PBM GAME EVER!!! A \$15.00 registration fee includes rules, 3-color map and 2 FREE turns. Thereafter, turns are \$4.75 each, NO HIDDEN COSTS EVER!

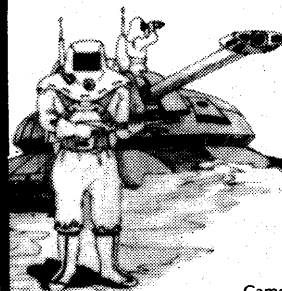

Game Systems Inc. P.O. Box 431870 Miami, FL 33243-1870

The role of computers

Our new columnists return with *Rogue*

by Hartley and Pattie Lesser

Games have their origins in the distant past, so far from the present that the time of their beginnings can only be guessed at by experts. Board games have been played for about 5,000 years; this group includes such old favorites as the Royal Game of Ur (Iraq, circa 3000 B.C.), Chaturanga (the forerunner of chess, from 6th-century India), and Go (China, circa 2000 B.C.). These forms of entertainment spanned all continents, with varieties of similar games being played in even the most geographically isolated areas.

The purpose of gaming is to bring enjoyment to the participants. The forerunner of what we know today as Tic-Tac-Toe could well have been invented by two slaves hard at work in a temple in Kurna, Upper Egypt (circa 1350 B.C.). A set of crosshatched lines strongly resembling a Tic-Tac-Toe board was found etched into roofing tiles in the ruins of that temple. Perhaps a couple of construction workers had managed a brief respite and designed this game to break the tedium of their labors. No copyright laws existed at the time to protect their invention — otherwise, who knows what a fortune their descendants might have amassed. . . .

Computer games have a history as well, albeit not as elongated as that of other gaming forms. Of course, computers themselves are a quite new development in the history of man, and even within that much shorter span of time computer entertainment is a fairly new function for a central processing unit (CPU) to manage. Early computers were little more than gigantic calculators. The invention of the microprocessor, which compacts circuitry that used to occupy square feet into measurements of microns, made computing power available to the masses.

One reason that some adventure games were initially coded on mainframe computers was to see what a large computer might be able to manage beyond the functions of strict calculation and data processing. These games developed large followings, with players begging time on the system to engage in these machine-mastered fantasies. College campuses became the focus of such activity, with students and professors working in the late evening and early morning hours on gaming projects to avoid conflict with the normal daytime activities (such as class instruction and laboratory work) for which the computer was originally intended.

At this point in computer-game development, the power of the

BUSHIDO™

Flashing bladework, brave warriors, martial mastery, wise priests, honor, stealthy assassins, demons, magicians, spirits, war — the stuff of Legends, the Legends of Japan. BUSHIDO is a role playing game that allows you to adventure on the Misty Isles of Nippon.

Players in BUSHIDO design their characters to suit the profession they choose. A skill system is used to determine the character's success in both martial and peaceful endeavors.

Take a break from the Western European and sample the mysterious world of the Far East. Try adventuring in a world where a man's honor and fame are as important as the number of foemen he has slain.

Come follow the code of the Samurai, the Way of the Warrior. BUSHIDO!

BUSHIDO is available for \$18.00. Also available is THE VALLEY OF THE MISTS, a BUSHIDO adventure pack for \$5.00.

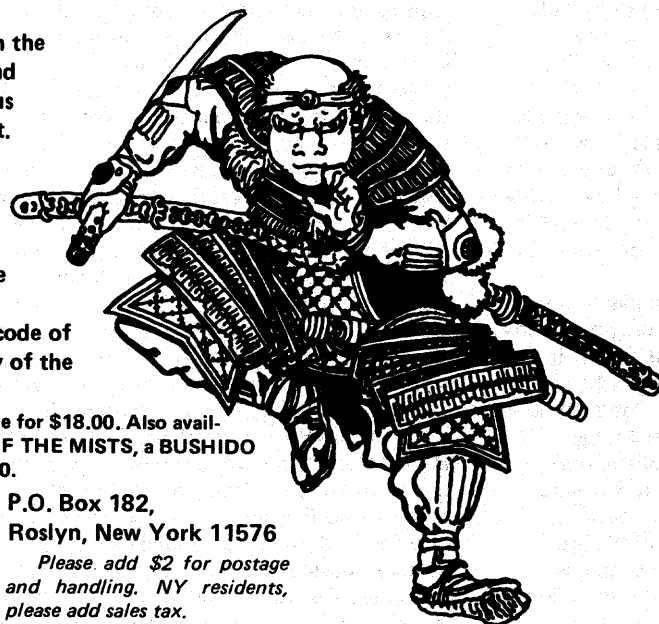

P.O. Box 182,
Roslyn, New York 11576

Please add \$2 for postage
and handling. NY residents,
please add sales tax.

A stack of DC Heroes role-playing game modules. The top module is "Purge and Ice" for 4 characters, 350-1000 Hero Points. Below it is "Doomsday" for 4 characters, 500-1000 Hero Points. The DC logo is visible on the top left of each cover. A small "M" logo is in the top left corner of the entire advertisement.

™ Indicates Trademark of DC Comics Inc. All character names, renditions, associated slogans, and indicia are Trademarks of DC Comics Inc. Copyright © 1986 DC Comics Inc. All rights reserved.

mainframe computer was required to master the coding. Microcomputers were just making their appearance, and did not possess the speed or memory requirements necessary to allow for the transfer, or porting, of code from the mainframes to their smaller environments. But technology marched on, processing speed and memory capacity increased, and the first commercially successful microcomputers entered the marketplace. Two of the most well-known pioneers were the Apple II and the TRS-80 Model I.

The first microcomputer games were rudimentary, possessing little in the way of graphics, with parsers that could only accept a few words. But as time passed, memory capacity increased even more, and the customary storage medium changed from cassette tape to floppy disk, which stepped up the speed with which a computer could access the stored information. When these improvements had come to pass, programmers found an environment suitable for relatively complex adventure games. Early developers such as Ken and Roberta Williams of Sierra On-Line Systems, Scott Adams of Adventure International, and Robert Hardy of Synergistic Software, and early magazines such as *Soft-Side* (edited by Mark Pelczarski and Dave Albert) began to imbue the burgeoning number of computerphiles with a craving for micro adventure games. The early titles, such as *Beneath Apple Manor*, *Odyssey*, and *Pirate's Adventure*, all sold well and set the stage for further development of the science and art of adventure-game programming.

The memory and programming requirements for porting extensive mainframe code into the microcomputer seemed prohibitive. But programmers are a resourceful group, and code compression as well as other innovative techniques eventually made it possible for the mainframe environment to be simulated at the microcomputer level. The featured review in this column is devoted to one such game that made this transition: *Rogue*.

Rogue is not just "an adventure game" — it justifiably could be referred to as The adventure game. Epyx has managed to bring the time-sharing version of this game to the IBM PC, Apple II, and Macintosh computing environs with aplomb, and the translation is extremely well done. Originally, *Rogue* was written on a Unix mainframe system by authors Michael Toy and Kenneth Arnold. The game can also be found running on many VAX minicomputer systems. But it really comes into its own in the microcomputer environment, where the micro's ease of use and accessibility combine to make an interesting game even more attractive.

Why such strong praise for a game that "simply" sends one into a dungeon to be pitted against strange foes while searching for treasure? Such a scenario has been repeated hundreds of times in other software presentations. True, but in this case *Rogue* requires the player to participate with some modicum of thought. The game is certainly not *all* slay, slay, slay for pay, pay, pay! (Although without doing the former, an adventurer would have difficulty garnering the latter.)

Someone once said that experience is the best teacher. *Rogue* is certainly proof of the wisdom of those words. The player can only learn through experience, and learn he or she must do in order to achieve the ultimate goal of success. After all, learning how to deal with an aggravated orc in the best and most fortuitous manner is somewhat akin to learning how to cooperate with your peers. As in life, so in *Rogue*: it's the end result that counts!

Every game has a specific main goal. In *Rogue*, the player must seek and retrieve the Amulet of Yendor. Created by magicians long ago as a remembrance for mankind, the Amulet sparkles with a purity and beauty found nowhere else. Such dazzling radiance was not appreciated by one person, the Lord of the Dungeon, a malefic being who has stolen the Amulet and hidden it deep within the Dungeon of Doom. How apt a name for this underground labyrinth, for few players have ever successfully recaptured the Amulet of Yendor. All sorts of beasties have been brought into his realm by the evil Dungeon Lord, and the creatures have a single purpose: to thwart every player's quest by making him vacate the dungeon — or, if he chooses to stand and fight, by taking his life.

The Dungeon of Doom is composed of 26 levels, and it is highly



recommended* that you completely conquer each level before proceeding down to the next deadly maze. Each level contains weapons, potions, treasure, food, armor, and spells that must be located and identified to learn how their use can help you complete the adventure. Cleaning out a level also requires the player to find and eliminate all of the hostile creatures inhabiting that maze. Success in combat increases a player's experience total, which enables him to withstand attacks from the tougher monsters to be found on the lower levels.

If you do succeed in locating the Amulet, things hardly get any easier. A new horde of monsters awaits on each level of the dungeon during your ascent back to the surface world, and you must reach the surface in order to return the Amulet to its rightful resting place and win the game.

Death can come swiftly within the dungeon, and perilous situations should be avoided at all costs. You can save a game in progress if your character is still alive, but if your adventurer dies you have to start over on level 1 — and to make matters worse, all of the knowledge and experience you acquired will be useless. The Dungeon of Doom changes in configuration every time the game is restarted from scratch, and the elements found in the labyrinth change location and function. A certain type of armor that protected you well in your previous game can be next to worthless in your next one; a potion that once filled your belly with food or imparted a bonus to your weapon now sends poison coursing through your body; a scroll that once detected the location of monsters now summons the evil beasties directly to your position. Your adventurer can continue to learn and grow as long as he survives, but an entirely different environment awaits each player that starts on level 1. This can be rather frustrating if you have worked to get an adventurer down to the 20th level before he expires, but the "different dungeon every time" feature also makes it possible to enjoy the game over and over again even if you do succeed in retrieving the Amulet.

Winning the game is difficult, but certainly not impossible. And the programmers have included some features designed to help a player cope with his environment. A map is revealed on the screen as your character explores the dungeon, displaying all the areas on a certain level that have been traversed. If you leave a level and return to it later, all the areas you previously explored will be redisplayed without your having to traipse through them again just to get the map back on screen.

This mapping feature is obviously of great assistance to the player, who does not have to spend valuable time penciling a map on graph paper. And time is indeed valuable; while a game is in progress, things continue to happen even though your character might not be doing anything. A stationary character, resting to catch his breath, can suddenly find himself under attack by a monster or a group of beasties. A player must pay constant attention to the screen display to keep his character alive.

Room searches must be accomplished on each level not only to find the gold, weapons, potions, scrolls, food, armor, and other goodies necessary to survival, but also to locate secret passages and doors that could lead to additional bounties. And again, you must learn from experience during each game exactly what can and cannot be of aid to you. Certain scrolls, when used, can help

you locate food supplies. A wise adventurer amasses food before being weakened by hunger . . . but you must also be certain that the scroll you are using is the correct one for food identification. A tangle of words spoken from an incorrect scroll could leave one under the constant and hostile eye of an unseen entity!

In all versions of the game, an adventure in progress can be saved to a separate data disk, and the game plays basically the same no matter what computer is being used. However, there are some significant differences in the appearance of the game display on the various machines it is designed for.

The original version, translated from the mainframe game, is written for the IBM PC and compatible machines. This version presents a screen composed of text graphics, which are letters and symbols obtainable from the computer keyboard. The text graphics are color-keyed, as shown in the accompanying photograph of a screen from a game in progress. Rooms are bordered with yellow walls (shown with an orangish tint in this photograph); passageways linking the rooms are displayed in light blue (which appears here as a light gray). Hostile creatures are represented by letters of the alphabet. Notice that in the room in the lower right of the pictured screen, the letter "E" is evident. Since the adventurer (depicted by the yellow oval) is a mere three spaces to the left of the creature, a decision to either fight or run should be made in the near future. The yellow asterisk shown in the same room indicates that some amount of gold is here and may be retrieved by the character, either before or after taking care of the "E" monster.

Other features in this screen shot include what appears to be a blue "I" and a blue circle in the room to the immediate left of where the adventurer is; these symbols represent a potion and a magic ring, respectively. The room at the top center contains a green square, signifying armor of some kind. As for the other symbols . . . well, we have to leave something for you to find out for yourself. The line of text at the bottom of the screen is displayed at all times, giving the current dungeon level, the charac-

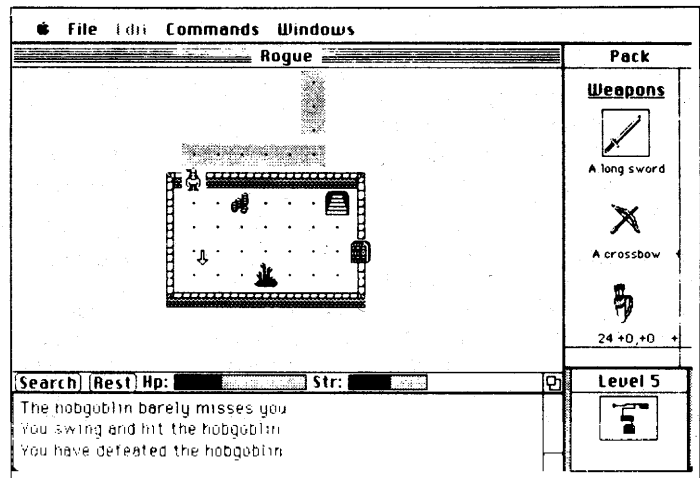

ter's state of health (current and maximum hit points), the character's strength (current/maximum), how much gold the adventurer has amassed, his current armor class, and his ranking.

The Macintosh version is the latest release of the game. It offers crisp graphics displays, detailed icons for the various sorts of objects and creatures found in the dungeon, plus four on-screen windows for information display. The accompanying printout of a screen display from a game in progress illustrates just how much information can be had on the screen at one time. A small map window in the lower right corner draws each dungeon level as the character explores it. To the immediate left of this window is a message display that gives the character's status (using a bar-graph representation instead of numbers) and offers information rele-



OMNI's Choice

Supremacy is the board game where you lead a Superpower. Your objective is to conquer the world through economic, political and military strategy.

You make decisions that face the world leaders today. Should you sell oil or buy grain? Build armies and navies or launch laser stars? Your toughest decision will be - to nuke or not to nuke.

OMNI magazine chose Supremacy as one of the *Ten Best Games of 1985*. The editors of *GAMES* magazine chose Supremacy for the *Games 100*. This is the list of their 100, all-time favourite games.

Supremacy Games Inc.
425 Statler Towers
Buffalo, NY 14202

©Supremacy Games Inc. 1986

"You can win in the traditional way by invading and conquering, or more subtly and shrewdly by buying or selling supplies of grain, oil, or minerals...you can try out various strategies long enough to make you eligible for a cabinet post."

Scot Morris - Games Editor
OMNI Magazine,
December 1985

"...the people at Supremacy Games have put together an exciting game with clear, simple rules and a minimum of luck. As with any game though, what you base your final judgment on is fun and Supremacy is definitely fun."

Ted A. McDonald
GAME NEWS,
December 1985

"...fascinating saga of economic development and military conquest... players will be experimenting with different strategies for many games."

Sid Sackson
GAMES Magazine,
July 1985

Available at your local dealer -
suggested retail
price \$35.00

Omni Top 10
Games 100



™ indicates Trademark of DC Comics Inc. All character names, renditions, associated slogans, and indicia are Trademarks of DC Comics Inc. Copyright © 1986 DC Comics Inc. All rights reserved.

vant to what has just happened (the value of treasure found, the outcome of combat, the nature of found objects, and so forth).

Directly above the information window is the Rogue window, a large display showing your character, the room he currently occupies, and all the features to be found in that room. Finally, the Pack window along the right side shows the items your character is carrying; in the illustration shown here, weapons are displayed, and the adventurer is currently armed with his long sword. To use an item in one's Pack, the player activates the desired item by double-clicking the mouse on that object, with the message display confirming the selection. To use a bow and arrow, for instance, you first double-click on the bow to establish that as the weapon your character is carrying. Next, the arrow icon is selected with a single click and dragged into the Rogue window. The cursor turns into a directional arrow, and when the arrow is moved to point directly at the intended target, you simply release the button on the mouse. The arrow flies toward the target and, depending on your character's ability and luck, strikes or misses the opponent. This interaction affords the player the feel of actually having to draw the bow to fire the arrow — a nice extra touch of the sort that isn't offered in most adventure games.

As of the writing of this column, *Rogue* is available for the Macintosh, IBM PC, and IBM PCjr computers. Versions for the Commodore Amiga and Atari 520ST were in development, according to the folks at Epyx, with a planned release date of June 1986 for both new versions.

As far as what's new in the software gaming world, there's good news for fantasy adventurers. Infocom has announced a new offering entitled *Trinity*, which is the first of the company's puzzle-oriented games to be written using their Interactive Fiction Plus development system. In *Trinity*, the player is part of an alternative universe where magic and physics coexist, a world where every atomic explosion that has occurred is somehow connected to all of the others. The program's parser understands a vocabulary of

2,000 words (compared to around 600 for most of Infocom's other text-adventure games), and the game universe contains nearly 600 objects and locations to be examined and explored. *Trinity* will be available for the Amiga, Apple II family, Atari ST, Commodore 128, IBM PC and compatibles, and Macintosh computers for \$39.95.

We have started really getting into a couple of games that were mentioned in our previous column. The first one is *The Wizard's Crown* from Strategic Simulations Inc. This game provides a total adventuring environment that is highly dependent on character development.

The second is *The Bard's Tale* (subtitled *Adventures of the Unknown*), from Electronic Arts. Certainly not for the weak-willed, this adventure game will probably take hundreds of hours to play all the way through. There is, in our opinion, too much emphasis on the kill, and impatient players probably won't stick around to build their characters for their final descents and ascents into dungeons and castles to finish the adventure. However, it seems that the more time one invests in the game, the better it gets; an experienced and accomplished party can expect to encounter horrific, spell-casting dragons as well as wizards, conjurers, and others of that ilk along the way.

Based on brief looks, we continue to be impressed with some other offerings that may get their share of the limelight in columns to come. These games include:

- Alter Ego*, Activision (Apple II, Commodore 64, Macintosh)
- Ancient Art of War*, Broderbund (IBM PC, Macintosh)
- Balance of Power*, Mindscape (IBM PC, Macintosh)
- Phantasia II*, Strategic Simulations (Apple II)
- Strategic Conquest*, PBI Software (Macintosh)

If you have any questions or comments you'd like to share with us, you can write to us directly at 179 Pebble Place, San Ramon CA 94583. Or, you can address comments to DRAGON® Magazine, P.O. Box 110, Lake Geneva WI 53147. Either way, your thoughts will be read and respected. Thanks for joining us, and play on! ☉



Chivalry and Sorcery™

- New, completely revised and boxed edition now available. The complete fantasy role playing adventure game for \$20.00.

Also available:

- C&S SOURCEBOOK with expanded rules. \$8.00
- C&S SOURCEBOOK 2 with lots more. \$6.50
- SWORDS & SORCERERS to expand C&S to the worlds of the Vikings, Mongols and Gaels. \$6.00
- BIREME & GALLEY with the naval rules for C&S. \$13.95
- THE DRAGON LORD as the first C&S adventure pack. \$5.00

Please add \$2 for postage/handling.
NY residents, please add sales tax.

AVAILABLE AT
BETTER STORES
or direct from us at
P.O. Box 182
ROSLYN, N.Y.
11576



DAREDEVILS™

HAVE ADVENTURES!

You can too! **DAREDEVILS** is a game of role-playing action and intrigue set in the 1930's. Players design and develop their characters who may be investigative reporters, private investigators, globe-trotting soldiers-of-fortune, mysterious cloaked crimefighters, or any of the heroes fostered by the popular culture of the era. The Gamemaster incorporates these characters into fast-paced adventures full of master villains, mysteries, fog shrouded streets, furious gun battles, and cliff-hanger escapes.

So, come and join the adventures.
Become a Daredevil!



DAREDEVILS comes as a boxed set that includes the rulebook, a referee's screen with useful charts and a political map of the world, and **DAREDEVIL ADVENTURES**. This last is a collection of four adventures which allows you to begin play with a minimum of preparation.

The boxed set is available for only \$15.00.

ALSO AVAILABLE:

- *Daredevil Adventures 1: featuring Deadly Coins*
- *Daredevil Adventures 2 with Menace Beneath the Sea*
- *Daredevil Adventures 3: Supernatural Thrillers*

Each adventure is \$5.00

Cloaked in magic

Garments that do more than keep the wind out

by Ed Greenwood

I've recently learned that my friend, Elminster the sage, was (and is!) a mage of some power — perhaps even an archmage. So, when one of our conversations drifted around to the topic of magical garments, I was unusually interested. I pressed him for details of robes of magery and the like, but he merely chuckled, and said, "Adventurers — and no doubt your readers — will probably be more interested in the things of magic that *all* can wear, be they farmer or king, fighter or cleric, orc or elf. In the Realms, there are cloaks, magical cloaks, that were once made in great numbers in the city of Silverymoon, long ago in the north. Like all the best garments of magic, these cloaks alter instantly to fit whatever roughly man-sized creature dons them, and they are always of nondescript, weather-beaten brown or grey appearance."

Elminster refused to pass on the secrets of making such cloaks, but did detail what powers nine "types" of them have, "in case anyone who reads this runs across one and has need of the information."

Cloak of battle

This cloak will entangle any weapon parried by it (treat any unsuccessful "to hit" roll of an opponent upon the cloak wearer or wielder as a parry). Magical weapons must then make a saving throw of 20, with a bonus equal to their magical bonuses; those magical weapons without combat bonuses save on a 20, and all artifacts save at + 5 on the die or at their own plus, whichever is greater. Failure to make the save binds the weapon fast to the cloak for 1-3 rounds. This entanglement prevents further attacks using that weapon, and a bend bars/lift gates strength roll is needed to pull the weapon free prematurely. If the attacking creature leaves or moves away to engage another opponent before the 1-3 rounds are up, it must part company with its weapon, which remains in the possession of the cloak-bearer.

The cloak has one other function; upon the speaking of a command word while the cloak is held (but not worn), the cloak will be transformed into a stout bar or cudgel for 5-8 rounds. The cudgel is largely composed of magical force, will not

be damaged by normal usage (*i.e.*, all except contact with magical weapons or spells), counts as magical for "to hit" purposes but has no bonuses, does 1-6/1-3 hp damage, and cannot be used to entangle other weapons as above. The cloak can be destroyed by parrying (in the above manner) eight blows from magical weapons while in this form, and it can be wielded by characters of any class without proficiency penalties.

Cloak of comfort

This cloak imparts (to the wearer only) equable temperatures for comfortable studying, physical activity, sleep, and so on. It does this by alternatively exuding heat or cold that it has magically absorbed (including the heat of the sun, the chill of night breezes, and extremes of temperature common to deserts, glaciers, and other inhospitable regions). The cloak's outlines are always clearly visible to creatures having infravision. Notably, cold- and heat-based magical attacks are absorbed by the cloak harmlessly; thus, the wearer is immune to *cone of cold*, *heat metal*, and similar spells.

Note that most fire-based spells and magics such as *ice storm* do damage for other reasons than merely the temperature of their effects. The wearer of a *cloak of comfort* suffers -2 hp per die of damage from *ice storm* and fire-based magics of all sorts, although the cloak itself is immune to the effects of flame and freezing. Electrical and other energy attacks are unaffected by such a cloak. The capacity for absorption of such a cloak is not known — none is known to have ever "overloaded" nor, when destroyed, to have exploded or emitted any bursts of heat or cold. The wearer of such a cloak never suffers the effects of exposure to the wilderness, such as reduced constitution, dexterity, etc. Sunstroke (due to ultraviolet radiation) and water damage to accoutrements, etc., are still possible. Hypothermia and the fatal effects of frigid waters are not possible.

Cloak of fangs

This cloak can be worn as a normal, heavy-wear, all-weather cloak for an unlimited time, but when magically activated will serve only once. The word of activation for all such cloaks is "Feerond," the

name of their maker. When this is spoken, the cloak is dangerous to the wearer's friends and foes alike; it fires darts of pure force up to 3" distant in all directions, this spray of invisible missiles lasting for seven rounds regardless of the cloak wearer's intentions. The cloak wearer will never be struck by any of these missiles, nor do such missiles ricochet, but all creatures within 3" of the cloak-wearer (who may, of course, move and fight normally) suffer 6-24 hp damage per round; a save vs. spell means half (3-12) damage, and spells such as *shield*, *wall of force*, *anti-magic shell* and the like will offer complete protection against the missiles. The missiles also cannot penetrate other planes (*i.e.*, the ethereal) or extra-dimensional spaces (*e.g.*, those created by a *portable hole* or *rope trick* spell), although if the cloak wearer

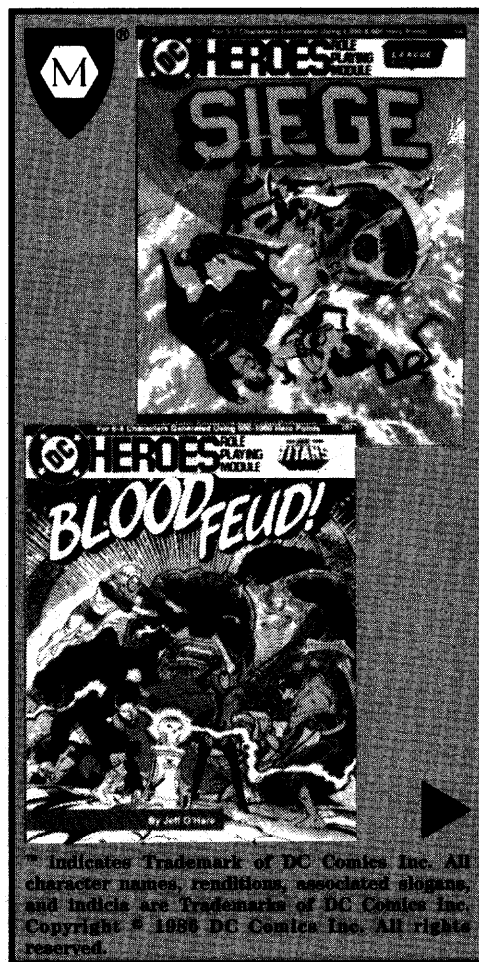

enters such a space or plane by some means, the flurry of missiles will accompany him or her. The missiles do not hamper the movement rates of affected creatures, but do prevent spellcasting that involves somatic and material components. At the end of the seven-round flurry of missiles, the cloak vanishes forever.

Cloak of many colors

This rare garment can so shift its pigmentation that its wearer is immune to the effects of *color spray*, *prismatic spray*, and the like, and can pass through a *prismatic sphere* or *wall* (together with all items carried or worn within the cloak) as though the barrier did not exist. The wearer *only* (not companions) is so protected, and he is likewise solely protected from blindness due to *blur*, *pyrotechnics*, *hypnotic pattern*, *darkness*, blinding light of all sorts, and magical effects.

The cloak itself does not seem to an observer to alter its own colors, but will always seem to have a swirling and indistinct surface (aiding the success of a wearer hiding in shadows by +10%); more so when it is acting to shield its wearer's gaze from color effects cast at the wearer. The cloak cannot, however, deliberately be used to camouflage the wearer by blending with surroundings, nor does it have any powers to affect creatures other than the wearer, either by attack or by conferring protection.

Once every 12 turns, the wearer, by effort of will, can cause the cloak to glow (equivalent to a *light* spell, but *not* blinding) white, such glowing lasting for nine rounds, without any concentration required, or ceasing sooner if the wearer wills. Obviously the wearer cannot hide in shadows while the cloak is thus used.

Cloak of reflection

This cloak (*many* were made) confers a limited spell immunity upon any one, living creature wearing or covered by it. The following spells and spell-like magic-item functions — and *only* the following spells — are directed back at the caster/wielder as follows:

Magic missile — Reflected back at caster with full effect (no saving throw).

Shocking grasp — Discharge directed back instantly into caster and nullified; caster takes no damage, but spell is lost.

Forget — Spell distorted and thrown back at caster, who is *confused* (as per the 4th-level magic-user spell, *confusion*) for the following round (no saving throw); the *forget* spell is lost, and neither caster nor cloak wearer *forgets* anything.

Irritation — Reflected back at caster, who is affected normally unless save is made (negates effect).

Ray of enfeeblement — Reflected back at caster, who is affected normally unless save is made (negates effect).

Hold person/animal/monster (if cast at

cloak wearer) — Distorted by the cloak and reflected back at caster, who must save vs. spells (at par) or be *slowed* for two rounds.

Tasha's uncontrollable hideous laughter — Reflected back at caster, who is affected normally unless save is made (but the caster's saving throw is always at par, never at a minus due to intelligence).

Polymorph other — Reflected back at caster, who must save at +2 or be affected normally (system shock roll must be made, form received is as the caster intended).

Feeblemind — Reflected back at caster, who must save vs. spells at +2 or be affected normally.

Color spray — Reflected back at caster, who must save vs. spells or be struck unconscious for 1-2 rounds.

Entangle — Cloak wearer is unaffected by *entangle*, but the spell has normal effect on other creatures within area of effect; magic is *not* reflected back on the caster.

These cloaks were made to protect rangers and other traveling messengers in the service of the High Lady of Silverymoon. The precise magical defenses against each spell are now unknown, the knowledge having died with the maker of the cloaks, the mage Irentalar. The caster or wielder can escape the cloak's reflective effects only by escaping into another plane (or extra-dimensional space). Momentary dislocations such as *blink*, *dimension door*,



SKYREALMS of Jorune™

SKYREALMS of JORUNE is complete role-playing on a complete world. The boxed edition contains four books—everything needed for play (besides dice). Three player character races are offered to Jorune adventurers, though the necessary rolls for all other races are provided. Our character-sheets usher in a new age of playability; all percentiles for skills are listed, and are easily highlighted. With these sheets, Jorune's combat system is role-playing, and accurate, action-packed adventure is the result. An amazingly detailed encounters system, unique to Jorune, gives referees the foundations to build palpable Jorune adventures. A cultural and survival guide, written by sages and high-ranking Jorune officials, is included, as is an introductory Jorune campaign. All books are strikingly illustrated by Jorune's co-designer, Miles Teves. Maps included. Boxed Edition: \$25.

(mail order: add \$1.50 for shipping). For more information, contact your dealer or distributor, or write to us directly, at 526 MISSION • SANTA CRUZ • CA • 95060 •



LEAVE YOUR WORLD BEHIND

and *teleport* are not sufficient to escape, and distance is not a factor. Elminster does not know of any instance in which the wearer of such a cloak faced a creature having spell-like *natural* powers akin to the spells reflected by the cloak, but believes that such spell-like powers would be reflected as are spells and magic-item functions.

Cloak of stars

The inside of this cloak contains four stars around the neck and front hems, six-pointed shapes of silver cloth. These are enspelled and radiate magic. If a star is touched and the name of its maker spoken (Thalanta the Fair made most of these cloaks), the star will vanish and the spell stored within the star will be activated. The knowledge of the making of such stars is lost, and thus they cannot be replaced. Moreover, there is nothing to identify what spell is linked to what star, although a few sages know the secrets of the patterns in which the stars were placed, and can deduce what spell each star will trigger. Only one star may be activated per round; it will cause a spell to be cast as though by the cloak wearer or bearer (regardless of that being's class or level), and the spell will take effect as though cast by a magic-user of 20th level, for that is what Thalanta was.

The usual spells stored in a *cloak of stars* vary according to which of three types of

cloaks is found:

1. *Teleport, enchant an item, spirit-wrath, limited wish*
2. *Anti-magic shell, Repulsion, reverse gravity, imprisonment*
3. *Death spell, legend lore, statue, shape change*

Such cloaks are very rare, version #3 especially so. The patterns in which the stars were placed inside the cloaks vary as well. The three known variations (which do not necessarily correspond to the three types of cloaks as noted above) are: a three-star triangle inside the right front throat hem, one star in the center of the triangle; four stars in a square on the left front throat hem; and, two stars down the right front hem and two stars down the left front hem. Some speak of a fourth combination — four stars in a diagonal row by the right front throat hem — but what spells any of these patterns correspond to, only a few sages know or are able to discover. The stars can, of course, be activated without knowing what spell will occur; knowledge of the spell power will fill the star-activator's mind in time for the spell to be directed at an area or specific target (but *not* negated or saved for later).

Cloak of survival

While wearing this cloak, any being gains a +2 bonus on all saving throws vs. poison and has a -03% penalty to the
(Continued on 2nd page following)

PSI WORLD



ROLE PLAYING GAME OF PSIONIC POWERS

An exciting new role playing game in which characters use or deal with awesome psionic powers in a near future setting. PSI WORLD offers over seventy-five different skills, twenty-five psionic disciplines, and over ninety specific psionic abilities.

The Gamemaster chooses the nature of the near future society, and with the input of the players, selects the style for their campaign. There are two options:

- The Government has attempted to gain dictatorial powers and uses the Psis as scapegoats to distract public attention from the Government's illegal grab for power.
- The Psis are a true threat to democratic rule as they use their powers to gain unfair advantages in business, politics, and all aspects of daily life. Players take the roles of members of the Psi Police to protect the public from this psionic menace

Be a Psi and control awesome powers of the mind! Protect the innocent from those with great powers as a member of the Psi Police! The choice is yours. Seek adventure in this fast paced game of action and excitement in a near future setting. The only limits are your own imagination!



PSI WORLD includes complete and easily understandable rules, the PSI WORLD ADVENTURE with introductory adventures to get your campaign started, Gamemaster's Screen, and master character sheet suitable for photocopying. Everything needed to begin your PSI WORLD campaign is included in the boxed set. All of this is yours for only \$12.00.

Available from better shops or direct from Fantasy Games Unlimited at P.O. Box 182, Roslyn, New York 11576.

Please add \$2 for postage and handling. N. Y. residents please add sales tax.

ILLUMINATI™

The Fast, Exciting, New PBM Game Of Intrigue And Strategic Conflict

Now you can become the absolute master of one of Earth's most powerful secret organizations. Your agents eagerly await your orders. Your mission is nothing less than **Total World Domination!**

JOIN THE PBM CONSPIRACY

- ▲ Twenty-four players per game
- ▲ Full diplomacy — make and break alliances
- ▲ Send messages through the computer
- ▲ Every player's position is different
- ▲ Every player has a unique secret power
- ▲ Clear rules with excellent examples
- ▲ Simple, easy-to-complete turnsheet
- ▲ Detailed reports on all results, in English
- ▲ No turn deadline, no missed turns
- ▲ 24-hour turnaround guaranteed
- ▲ Completely computer-moderated
- ▲ Professional management
- ▲ Over 20,000 turns processed
- ▲ \$7 (U.S.) for setup, rulebook, and 2 free turns
- ▲ Only \$4 (U.S.) per turn — never an extra charge

"Great rules, great action, just an incredibly great game!" — Jeff Ferris

"HIGHLY RECOMMENDED!" —Gaming Universal

For information, write to:

Adventure Systems
P.O. Box 22305-X
Houston, TX 77227

ILLUMINATI and the all-seeing pyramid are registered trademarks of Steve Jackson Games Incorporated. ILLUMINATI THE PLAY BY MAIL CONSPIRACY is a licensed version of S J Games' ILLUMINATI board game. All rights reserved. Fnord.

DC HEROES™ ROLE PLAYING REFERENCE

DC HEROES™ ROLE PLAYING MODULE

COUNTDOWN TO ARMAGEDDON

By Dan Greenberg

™ indicates Trademark of DC Comics Inc. All character names, renditions, associated slogans, and indicia are Trademarks of DC Comics Inc. Copyright © 1986 DC Comics Inc. All rights reserved.

WHAT THE @!¢%*# IS GURPS™

GURPS is a whole new approach to roleplaying — a game in which ease-of-learning, ease-of-play and realism go hand in hand. The rules are written in plain English. You won't need to learn a new language to play the game.

GURPS puts you on the battlefield with fast-paced combat. But realism and tactics aren't sacrificed for "playability."

And the battlefield can be anywhere, anytime. The *GURPS* system can handle any fantasy setting, any real-world setting — past, present, or future.

GURPS characters are more than the cardboard cutouts in most roleplaying games. Create characters just as you envision them — three-dimensional and easy to roleplay.

And the *GURPS* system is modular. You won't have to redesign the rules to suit your own needs. For the first time, you'll be able to choose the exact level of detail you want.

GURPS. The product of five years of development. The most flexible game system ever designed. The state of the art in roleplaying. The game you'll want to play.

GURPS. Not the first RPG. Just the best.

Watch for the *GURPS* Basic Set at your game store or send \$27.50 (Texas residents add \$1.00 sales tax) to:
Steve Jackson Games, Box 18957-D, Austin, TX, 78760

GURPS is a trademark of Steve Jackson Games Incorporated. All rights reserved.

chances of contracting any disease or parasitic infestation. In addition, the cloak maintains a supply of pure, breathable air, enough for the wearer *only* to breathe for one turn, within itself, replenishing this supply constantly whenever the surrounding air is pure, and automatically envelops the cloak-wearer's head in it whenever breathable air is not present (i.e., if the cloak wearer is enveloped in choking smoke or plunged into water, he or she can see, breathe, and act normally for up to one turn).

Incidentally, the wearer of this cloak is immune to nausea and its effects, and to the person-affecting cantrips *belch*, *cough*, *sneeze*, and *yawn*. Note that poisonous vapors are protected against for one full turn, and only thereafter must the cloak wearer save (at +2) to avoid any effects.

Cloak of symbiotic protection

This type of cloak is very rare. It is im-

pregnated with an immobile, non-intelligent living substance of unknown identity and origins which cannot be isolated by alchemists and naturalists for study. The symbiote drains one hit point of vitality from the wearer every other time it is put on (or, if worn continuously, once every two days) and makes the wearer color blind while the cloak is worn.

In return, the cloak confers immunity to the effects of green slime, olive slime, obliviax, violet fungi, yellow musk creeper, yellow mold, and russet mold (but not brown mold). In addition, spore attacks of all other sorts (including those of the myconid, ascomoid, basidironid, and similar creatures) are saved against at +4. The symbiotic life form in the cloak seems to feed upon and neutralize spores and microscopic airborne life of all sorts; in many cases, this power will confer upon the cloak wearer a -06% penalty to the chances of contracting diseases.

Dawn of a new age

(From page 8)

stuff that will make you frown, or groan, or that just might make you sit up straight and say "Wow!" We're going to try to recapture whatever it was that the magazine had three or four years ago — the flavor and the outlook that got a lot of you reading in the first place, and which you have come to miss since then. Instead of worrying so much about crossing the i's and dotting the t's (See, we forgot already!), we're going to direct our efforts toward giving you interesting reading. Some of the articles may be a little rough, and not completely well thought out — but if they make you *think*, then we will have done what we set out to do.

The bad news

You're not going to get everything you want, at least not on an issue-by-issue basis. Some of you don't like extra-long articles, but we can't — and don't want to — avoid using occasional pieces such as the one that begins on page 10 of this issue. It's a good article, and if it happens to be 15,000 words long . . . well, you're going to have to take the bad with the good.

Some of you don't like the abundance of advertising we print, or the way we use ads among and between the pages of an article. I've addressed the former subject before, and won't belabor the point here; suffice it to say that, in this business, there is no such thing as too much advertising. As for the latter: If anyone out there knows how to get three two-page articles and five full-page ads into eleven pages without splitting up an article *somewhere*, every editor in the world would love to know how he does it.

Most of you hate having to turn from one part of the magazine to another just to read the last part of an article. (Boy, that's a question we never should have asked.) But sometimes it can't be helped; an article may simply be too long to run on a block of consecutive pages, or maybe there's an odd-shaped hole on a page somewhere that can't be filled without jumping an article to fill that space. We'll try only to jump an article when we absolutely have to, and at least nine times out of ten you'll be able to figure out why such a distasteful tactic had to be employed. The other one time out of ten, if you can't figure out a reason, you can assume that we did it just to aggravate you. We have to get some fun out of this job once in a while. . . .

Scrapping the strength limitations is more realistic than continuing to treat females as inferiors. I find it ironic that at the end of his article Mr. Mohan argues for playability over realism, but apparently does not think either concept should be employed for the fair treatment of females in the game.

I enjoyed the AD&D game when I first began playing it. I had not read the rules closely and had assumed that it wasn't sexist. Had I known it was, I never would have tried it. With the amount of bigotry and sexism that is found in reality, who needs it in a game that is supposed to be fun?

Darcy Stratton
Eugene, Ore.

Cloak of the shield

The wearer of this cloak can project a shieldlike field of invisible force once every two turns, maintaining and moving this force field by conscious mental control. The field lasts up to three rounds, in the form of a square 10' × 10' across and four inches thick. The wearer can employ this shield without strain within 4' of himself as a shield, protecting himself or another single being, so that it acts as a *wall of force* (as per the magic-user spell), a weapon (striking as an invisible ramming force, doing 1-10 points of damage per blow, one blow per round, no saving throw), as a bridge or barrier (like a door), or as a "floating disc" (like Tenser's spell). The wearer can shift the force field to fulfill any or all of these functions in any order, but it may so serve only in one capacity per round. If not maintained by constant mental control (i.e., the wearer cannot be struck unconscious, stunned, *charmed*, *confused*, *feebleminded*, or psionically attacked, and cannot himself cast spells), it will cease to exist instantly.

Attacks upon the field of force do not affect the cloak. Elminster reports that some of these cloaks have lost their powers when used often — and therefore advances the hypothesis that such cloaks have a limited number of magical charges or uses before they are exhausted. The truth of this, it must be stressed, is presently unknown.

Ω

The forum

better saving throws, the chance to attract followers and build a stronghold, etc. The most ridiculous case is that of the elven ranger, where the male can gain up to three levels above the female on the basis of strength. How this brute strength allows him to be better at tracking and spell casting is not explained. Realism, huh? Female gnomes and halflings get no chance for 10% on earned experience, and female halflings are excluded from the thief-acrobat class (or hasn't anyone noticed this?).

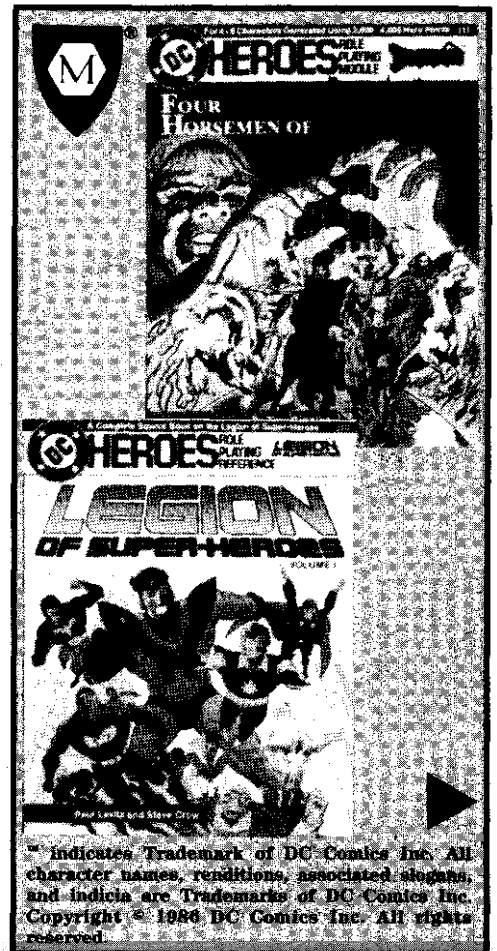



HEROES ROLE PLAYING GAME

"Mayfair did an outstanding job on this one."

—Fantasy Book

"DC HEROES is a must-buy for long time gamers who want to sample the richness of the DC Universe. And for new players who want a challenging game . . ."

—Comics Feature

★★★★

The game system: A minor miracle . . . the system doesn't break down . . . I recommend it unconditionally . . ."

—Different Worlds

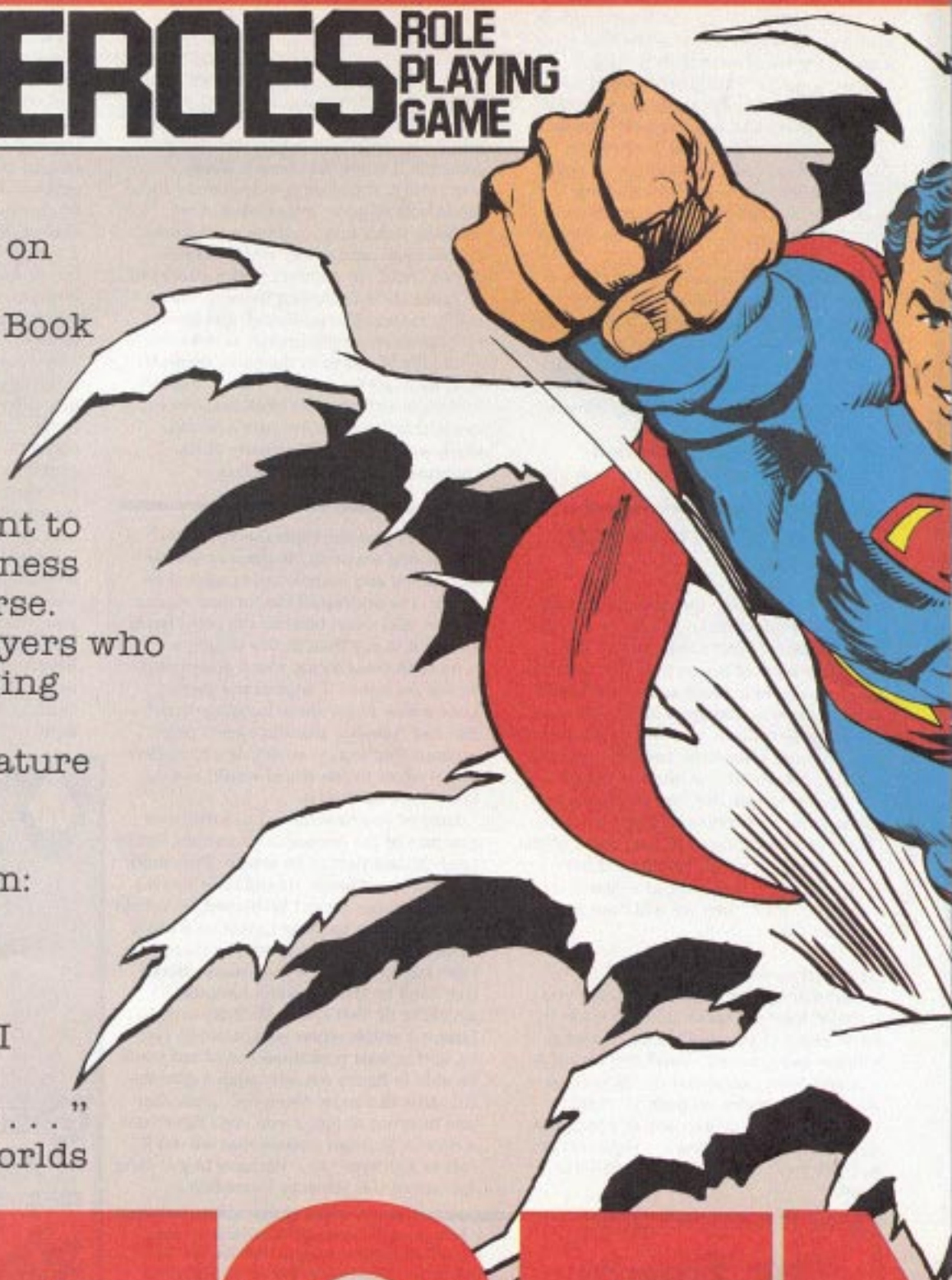

LEGEND



"A game which an experienced player can enjoy, but a player can also bring in a novice and teach him or her the basics of role playing . . ."

—Comics Collector

"DC Comics is represented in the superhero role playing game field with a powerful new entry . . . the best that Mayfair has done yet."

—Dragon®Magazine

"... an innovative, thoughtful, respectable superhero role playing game."

—Space Gamer

ADADARY

MAYFAIR GAMES P.O. BOX 48539 NILES, IL 60648

DRAGON is a registered trademark owned by TSR, Inc.

Capture and bring to life the entire spectrum of comic book Heroes!

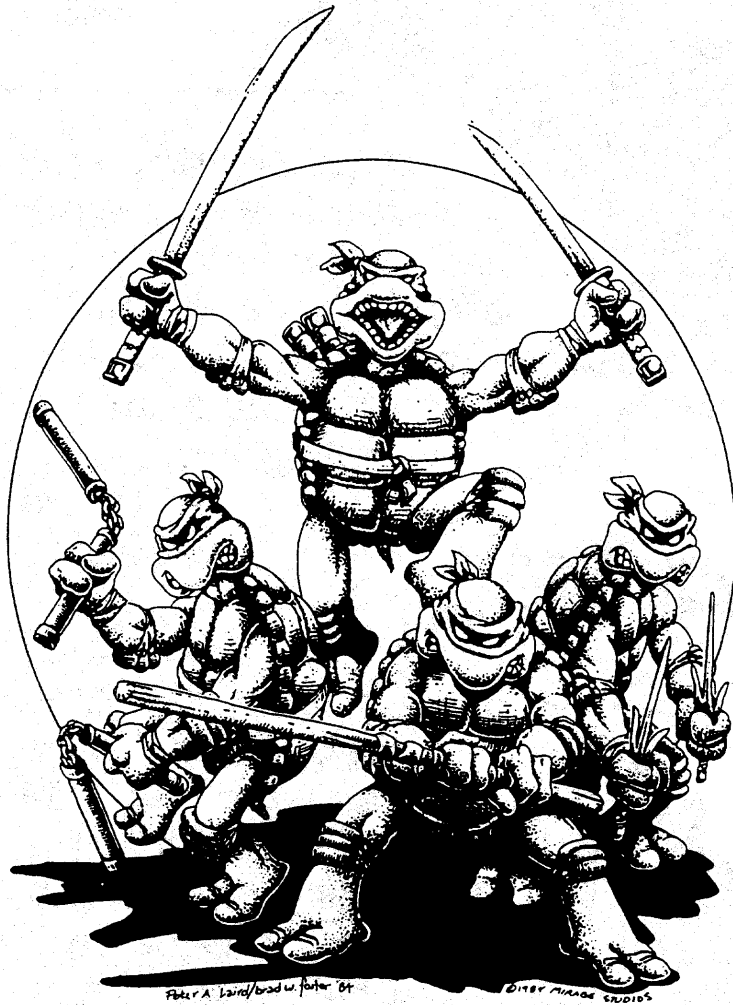

Teenage Mutant Ninja Turtles & Other Strangeness

The possibilities for Teenage Mutant Ninja Turtles are endless. Whether you want to play straight comic book super heroics, post-holocaust mutants or frantic funny animals, it's all possible.

Now you too can transform ordinary house pets into the superheroes of tomorrow. From the family feline or hamster to lions, tigers and bears, you can create the most unusual superbeings in the annals of history.

Teenage Mutant Ninja Turtles & Other Strangeness loyally adapts the comic book with each character, from Raphael to Casey Jones, depicted complete with background and abilities.

Highlights Include . . .

- A complete NEW game!
- Compatible with Heroes Unlimited® and the Mechanoids.
- Dozens of characters, villains and heroes.
- Several adventure scenarios and scenario ideas.
- An all NEW eight page Ninja Turtle comic strip by Eastman and Laird. Plus page after page of Eastman and Laird art throughout the entire book!
- \$9.95 (post paid)

HEROES UNLIMITED®

Despite all the other superhero games on the market **Heroes Unlimited**® is still the only game that covers every aspect of the comic book hero. Only **Heroes Unlimited**® enables you to build/create a robot or cyborg, in addition to superspies, psionics, aliens and mutants. Comprehensive skills, education and back-ground, enable you to create three-dimensional characters that grow and develop. Guess-work superpowers are replaced by exact power descriptions. Combat is quick, clean and playable.

Highlights Include . . .

- Steranko Cover
- Weapons and Equipment
- Robotics
- Bionics
- Psionics
- Spies
- Mutants
- Aliens
- Special Training
- Superpowers and Skills
- An Introductory Adventure Scenario and More!
- \$14.95 (post paid)

Palladium Books®
5926 Lonyo
Detroit, Michigan 48210

After the Bomb!®

A post holocaust science fiction odyssey!

Four generations after World War III, after the nuclear winter, after the plague and after the collapse of humanity, intelligent mutant animals lay claim to much of the world. Join the animal civilizations, the **Rodent Cartel**, **Wolf Barbarians**, **Bird Island**, **Gatorland**, and the **Gun Bunnies** in their struggle against the **Robot Warriors of the Empire of Humanity**.

Highlights Include . . .

- Animal Mutations.
- Robots and High Technology.
- Six Adventure Scenarios.
- Compatible with Heroes Unlimited®
- \$6.95 (post paid) — 48 Pages

A supplement for Teenage Mutant Ninja Turtles & Other Strangeness

Teenage Mutant Ninja Turtles Adventures!

The adventures continue as our heroes travel to Japan to take on the **White Ronin** and his assassins in "Death Trials." Then back to New York to thwart the ever imbalanced **Doctor Feral** and his 'New' monstrous mutations. The **Terror Bears** reap mayhem in a game of nuclear roulette. The unstoppable Mr. Bionic and other adventures round out this Ninja Turtle game supplement.

Highlights Include . . .

- A specially commissioned all NEW ten page Ninja Turtles comic strip by Eastman and Laird.
- The return of the **Terror Bears** and **Doc. Feral**.
- Five Adventure Scenarios.
- Compatible with Heroes Unlimited.®
- ALL artwork by Eastman & Laird!
- \$6.95 (post paid) — 48 Pages

Armor, piece by piece

Protection isn't an all-or-nothing proposition

by **Matt Bandy**

The *Oriental Adventures* AD&D® game book gives rules for partial armor, stating that each piece lowers the original armor class by a given amount. According to this system, a shin guard lowers armor class by one, offering as much protection as a shield. But would not a shin guard actually offer one's shin an armor class independent of that of the remainder of the body? To realistically present a partial armor system, a hit-location chart must be implemented, and partial-armor types must be described as to which areas of the body they protect and to what extent.

Hit location

Normal AD&D game combat consists of sparring with an opponent and striking whenever possible. When partial armor types are introduced to this scenario, however, it becomes implausible. The shin is not a tempting enough target (and would not be hit often enough) for a shin guard to contribute to the armor class of the whole opponent. The following table shows random hit location for a strike; independent of which hand the attacker uses.

Before rolling on this table, however, the defending player rolls a 20-sided die. A roll of 20 indicates that defender's shield catches the blow; if a large tower shield is used, a roll of 19 or 20 indicates this happens. For each magical "plus" of the shield, add a bonus to the roll. Thus, a *shield +5* protects the user on a roll of 15 or better, assuming a regular-sized shield is used.

Dice	Location hit
01-10	Head
11-15	Neck
16-30	Chest
31-40	Abdomen
41-45	Thigh
46-48	Shin
49-50	Knee
51-60	Upper arm
61-70	Lower arm
71-75	Elbow
76-80	Foot
81-85	Hand
86-95	Shoulder
96-00	Groin

In melee, a right-handed combatant will always strike the left side of his opponent's body, and vice versa. In missile fire, there

is a 50% chance of either the left or right side of the body being struck.

Partial armor types

There exists a protective piece of equipment for nearly every region of the body. These guards are made of materials ranging from steel to leather, and provide protection in directly varying degrees. The following table lists partial armor types as to which areas of the body they protect and to what extent.

Armor type	Areas protected	AC
Helmet, great	Head	1
Helmet, small	Head	3
Collar, leather	Neck	7
Collar, steel	Neck	3
Breastplate	Chest	2
	Abdomen	3
Mail tunic, leather	Chest	8
	Abdomen	8
	Groin	8
	Shoulders	8
Mail tunic, studded	Chest	7
	Abdomen	7
	Groin	8
	Shoulders	7
	Upper arms	7
Mail tunic, ring	Chest	7
	Abdomen	7
	Groin	7
	Shoulders	7
	Thighs	9
Mail tunic, scale	Chest	6
	Abdomen	6
	Groin	7
	Shoulders	6
	Upper arms	8
Mail tunic, chain	Chest	5
	Abdomen	5
	Groin	5
	Shoulders	5
	Upper arms	6
	Thighs	6
Mail tunic, splint	Chest	4
	Abdomen	4
	Groin	5
	Shoulders	5
	Upper arms	6
	Thighs	6
Mail tunic, banded	Chest	4
	Abdomen	4
	Groin	4
	Shoulders	4
	Upper arms	6
	Thighs	6

Thigh guard, leather *	Thigh	7
Thigh guard, steel *	Thigh	3
Shin guard, leather *	Shin	6
Shin guard, steel *	Shin	2
Knee guard *	Knee	3
Bracer, leather *	Lower arm	6
Bracer, steel *	Lower arm	4
Mail shoes *	Feet	4
Boots, high hard*	Thigh	8
	Knee	9
	Shin	8
	Foot	8
Boots, high soft *	Thigh	9
	Knee	9
	Shin	9
	Foot	9
Boots, low hard*	Shin	8
	Foot	8
Boots, low soft*	Shin	9
	Foot	9
Shoulder gd., leather *	Shoulder	6
Shoulder gd., steel *	Shoulder	3
Groin guard	Groin	3
Gauntlet *	Hand	3
Gloves, leather *	Hand	9
* - These items are sold singly, and may		
be bought for either the right or left side of the body.		

When two pieces of partial armor overlap, the armor class for that area of the body equals that of the more protective piece of armor.

Weight and cost for each piece of partial armor are shown on the following table; each figure is given in gold pieces.

Item	Cost	Weight
Collar, leather	1	10
Collar, steel	10	20
Breastplate	100	100
Mail tunic, leather	5	120
Mail tunic, studded	13	170
Mail tunic, ring	25	200
Mail tunic, scale	38	280
Mail tunic, chain	65	220
Mail tunic, splint	70	300
Mail tunic, banded	80	280
Thigh guard, leather	4	15
Thigh guard, steel	6	30
Shin guard, leather	3	15
Shin guard, steel	5	30
Knee guard	10	10
Bracer, leather	2	10
Bracer, steel	4	20
Shoulder gd., leather	5	15
Shoulder gd., steel	8	40
Groin guard	2	10

ARMOR CLASS BY ARMOR TYPE AND BODY PART COVERED

Body part	Armor Type								Plate			
	Leather	Padded	Studded	Ring	Scale	Chain	Splint	Banded	Mail	Bronze	Field Plate	Full Plate
Head	10	10	10	10	10	6	6	6	3	4	2	2
Neck	10	7	3	7	7	5	5	5	5	5	3	2
Chest	8	8	6	7	6	5	4	4	3	4	1	0
Abdomen	8	8	7	7	6	5	4	4	3	4	2	1
Thigh	8	8	7	9	3	3	3	3	5	5	2	1
Shin	6	8	6	2	2	2	2	2	2	3	2	1
Knee	8	9	8	3	3	3	3	3	3	3	3	2
Upper arm	8	8	7	8	7	5	5	5	5	5	2	1
Lower arm	8	8	7	10	8	8	5	5	3	4	3	2
Elbow	8	8	8	8	8	8	5	4	4	4	3	2
Foot	10	10	10	10	4	4	4	4	4	4	3	2
Hand	10	8	10	8	10	9	5	4	4	4	3	2
Shoulder	8	8	7	7	6	5	5	5	3	4	2	1
Groin	8	8	7	7	7	5	5	5	5	5	3	2

Scavenging partial armor

In any melee, there is a 1% chance per man-sized human, demi-human, or humanoid slain that a character, given time, will be able to salvage one piece of partial armor that will fit him or her. Given one hundred corpses, there is a 100% chance of finding one piece, and a 1% chance per corpse over one hundred of finding another; it takes one round to search one body. For each item found, one roll is made on the following table. Note that the composition of a piece of armor (leather or steel) depends entirely upon the armor used by the warriors. All other potentially important factors that could influence the sort of armor found must be considered.

Dice Item found

01-05	Helmet
06-10	Breastplate
11-34	Thigh guard
35-60	Shin guard
61-66	Knee guard
67-84	Bracer
85-00	Shoulder guard

For all items except helmets and breastplates, an even roll denotes that the item was made for the right side of the body, and an odd roll, the left. Thieves may only use partial armor types made of leather.

Suits of armor

Suits of armor may be fitted neatly into the partial armor system by determining

to what extent they protect certain areas of the body. The table at the top of this page gives these figures.

Combat procedure

Combat utilizing the partial armor system is conducted in this manner:

1. Initiative and surprise are determined.
2. The combatant with the first strike attacks, following this format: First, a roll is made on the hit location tables (making shield-hit rolls beforehand). Second, the combatant rolls to hit against the armor class of the body part indicated by the previous roll.
3. The combatant with the second strike attacks, following the same procedure. Ω

ACCEPT NO IMITATION

VILLAINS AND VIGILANTES™

A SUPER-HERO ROLE-PLAYING GAME

You can combat the forces of evil! You can become a champion of truth and an idol of millions! You can be a superhero and defend the human race against injustice and villainy! You can do all this as a character in VILLAINS AND VIGILANTES.

The rules deal with Superpowers, Combat, Secret Identities, Encounters, Character Creation and more! VILLAINS AND VIGILANTES comes as a boxed set with the rulebook, introductory adventure, character sheet, reference screen and dice for only \$12.00.

Rulebook Alone \$6.00
Introductory Adventure (Crisis at Crusader Citadel) . . . \$5.00

Additional Adventures Available: ● Death Duel with the Destroyers (\$5) ● Island of Doctor Apocalypse (\$5) ● Opponents Unlimited (\$5) ● F.O.R.C.E. (\$5) ● Assassin (\$6) ● Most Wanted, Vol. 1 (\$5) ● Most Wanted, Vol. 3 (\$6) ● Dawn of DNA (\$5) ● From the Depths of Space (\$5) ● Battle Above the Earth (\$5) ● To Tackle the T.O.T.E.M. (\$5) ● Devil's Domain (\$5) ● Pentacle Plot (\$5) ● Terror by Night (\$5) ● Organized Crimes (\$5) ● Pre-Emptive Strike (\$5) ● DNAgents Sourcebook is coming soon!

SHATTERMAN: An American military veteran and rock musician who uses his powers to continue to protect his country from the forces of crime and evil in general.
Identity: Jack Dunn
Side: Good
Age: 23
Level: 1
Powers:
1. Heightened Endurance: +19
2. Regeneration: Max, once per turn, takes one action, heals full healing rate.
3. Invulnerability/20
4. Flight: Max, airspeed = 279 mph, PR = 1/hr.
5. Power-Blast: 20 inch range, PR = 1 per shot, does 1d20 damage.

Weight: 145 lbs.
Strength: 9
Endurance: 31
Agility: 12
Intelligence: 15
Charisma: 12
Dam. Mod.: +2
Accuracy: +1
Hit Points: 18
Heal: 2.7
Car. Cap.: 278
Basic HTH: 1d6
Power: 67
Movement: 52'
Det. Hidden: 12%
Det. Danger: 16%
Invent. Pts.: 1.5
Inventing: 45%

Available from better shops worldwide or direct from us at:
P.O. Box 182, Roslyn, N.Y. 11576 (USA).
Please add \$2 for post and handling. NY residents please add sales tax.

FANTASY GAMES UNLIMITED

ROADSTRIKER

Take the action into the streets with this new supplement for MEKTON,™ THE JAPANESE ROBOT COMBAT SYSTEM. With ROADSTRIKER,™ converting MECHA CARS, ARMORBIKES, PERSONAL ARMORS, ADVANCED POLICE and HIGH TECH COMBAT VEHICLES are at your command! ROADSTRIKER comes with Basic Combat Map and counters, and the exciting Mecha Police adventure, ARCADIAN DEATHROAD™.

WITH ADVANCED TRANSFORMABLES — A new expansion for designing multiform MEKTONS! Now Astrofighters, Hydrofoils, Tanks, Walkers, Beastmecha and other exciting types can all be added to your MEKTON campaign!

R. TALSORIAN GAMES INC.
Box 2288, Aptos, CA 95001-2288

THE CHAOS WARS™ BULLETIN.

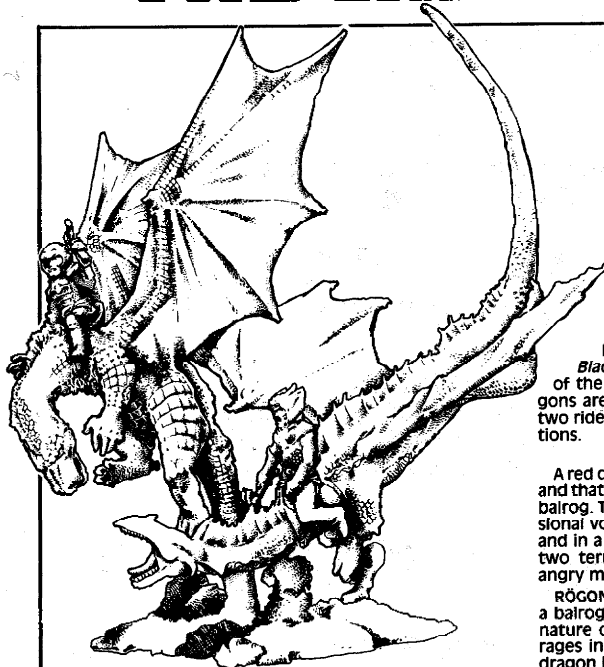

10-416 Duelling Dragons. Top: Leonaran and Goldancer, sculpted by Julie Guthrie. Bottom: Blasavius and Blacktooth, sculpted by Bob Charrette. Set comes complete with assembly diagram and character stats for all four! \$20.00

Duelling Dragons.

A grim struggle, frozen in an instant, between two contrasting personalities and two majestic creatures - a personal duel in the skies above the Chaos Wars!™ It's the 10-416 *Duelling Dragons*: two of the most awe-inspiring dragons Ral Partha has ever released, massive, threatening, and exuberantly detailed. Each dragon bears one of the 10-414 *Warlords* as a rider and the two of them are locked in a dizzying aerial showdown!

This is a very special release, combining the talents of two of Ral Partha's most accomplished designers. Julie Guthrie has sculpted the dragon *Goldancer*, whose rider is *Leonaran Dragonmaster* from the *Warlords* set; and Bob Charrette has created *Blacktooth*, bound in service to be the mount of the evil *Blasavius Dragonlord*. These two dragons are as different from one another as are the two riders and the philosophies that guide their actions.

RÖGON the Balrog Dragon.

A red dragon, breathing fire and plotting mayhem; and that most unspeakable of earth-spirits, a mighty balrog. Together they are caught in the Interdimensional vortex that is the heart of the Chaos Wars™, and in a blinding moment of terror and agony, the two terrifying creatures are fused into one very angry monstrosity!

RÖGON retains the devastating magical abilities of a balrog, and adds the earthly greed and vengeful nature of his original dragon form. His balrog half rages in fury at having been thrust into this semi-dragon body, with all its newfound limitations; and his dragon half shrieks in terror and agony at having to share existence with the fiery "spirit of might." This strange double-creature therefore lashes out at virtually anything it sees - a mighty berserker in the service of Chaos!



10-212 RÖGON the Balrog Dragon. Sculpted by Tom Meier. Comes complete with assembly diagram, painting instructions and character stats. \$8.00

The Destruction of Benden Woods.

The first of Ral Partha's *Chaos Wars*™ convention scenarios has been published! You can see it being played at various conventions around the country, or you can ask your local hobby dealer for it and play it yourself. It continues the captivating story of the *Chaos Wars*™: the massive, sweeping conflict between Order and Chaos, Good and Evil, that cuts across time and place and dimension!

In this first scenario, the peace-loving *Elves of Benden* are set upon by hosts of foul orcs and a riotous assortment of other horrible creatures. The attackers are led by *Starldrim*, the vengeful Drow Elf lord, and by *Geviririon* - the first of the extra-planar characters to appear in the *Chaos Wars*™. These grim personalities seek to destroy the *Benden Woods*, torch the elves' sacred heart-trees, and advance the odious cause of Chaos.

You can get a jump on acquiring the figures you'll need to fight this challenging miniatures battle by using the handy checklist at right.

From *Personalities and Things That Go Bump in the Night*, sculpted by Tom Meier:

- From *Personalities and Things That Go Bump in the Night*:
- 01-052 Hill Giant 4.50
 - 01-097 Grendel 2.50
 - 01-107 Briarose Knight, mounted on bumblebee and on foot 4.50
 - 01-118 Half Orcs (4) 4.50
 - 01-125 Champion of Chaos, mounted and on foot 4.00
 - 01-141 The Black Prince's Orc Guard (2) 2.50
 - 01-307 Starldrim, the Drow Elf Lord, mounted and on foot 3.00
 - 01-308 Artyn, the Sylvan Elf Thief, mounted and on foot 3.00
 - 01-310 Fealor, the Grey Elf Warrior, mounted and on foot 3.00
 - 01-311 Dwyndolin, the Sylvan Elf Warrior, mounted and on foot 3.00
 - 01-312 Adriel, in three guises 3.00

- From the *Fantasy Collector Series*:
- 02-003 Wood Elf, firing bow (6) 4.50
 - 02-010 The Elf Chariot 10.00
 - 02-014 High Elf, firing bow (6) 4.50
 - 02-050 Goblin-imp skirmishers (6) 4.50
 - 02-065 Orc Melee Troops (6) 4.50
 - 02-072 Orc Swordsman (6) 4.50
 - 02-078 The War Machine 20.00
 - 02-093 Wolf Riders (4) 4.50
 - 02-201 Wood Elf, with bow 1.25
 - 02-208 Sea Elf with sword 1.25
 - 02-211 High Elf with sword 1.25
- From *All Things Dark and Dangerous*:
- 02-909 Unicorn 2.50

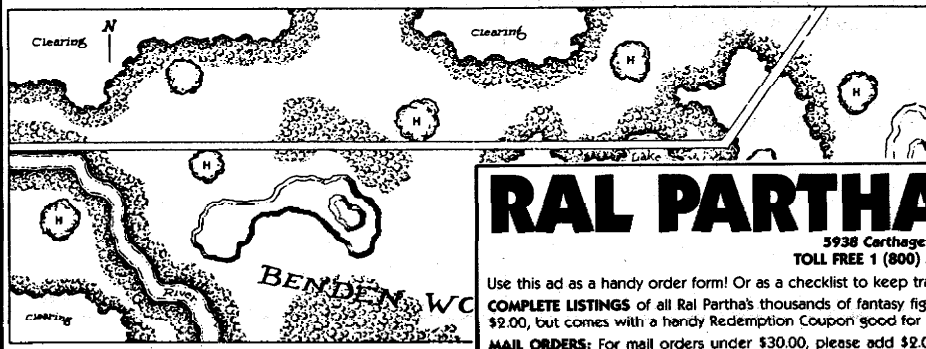

THE FIGHTER.

The first figure. The young adventurer is starting out on the first few levels, leaving hearth and home behind. He possesses only axe, shield, a short tunic of mail and an iron determination with which to issue his challenge to the fantasy world.



The second figure. The adventurer's challenge has been accepted more than a few times. His axe is larger now, as is his strength to wield it; and he has managed to acquire a little more in the way of armor.



The third figure. Where there was once trepidation and inexperience, now there is grim self-confidence and awesome fighting power. The adventurer now wields a massive, ornate axe and wears massive, ornate armor; he is the Master of his profession and few foes will now dare to contest him!



3-Stage Characters. Sculpted by Tom Meier. Each pack contains 3 figures to represent 3 successive stages in your character's development. 16 3-Stage Characters to choose from, including fighters, assassins, clerics, elves, dwarves and men. Call or write for complete information!

RAL PARTHA ENTERPRISES

5938 Carthage Court - Cincinnati, Ohio 45212
TOLL FREE 1 (800) 543-0272 • In Ohio, (513) 631-7335

Use this ad as a handy order form! Or as a checklist to keep track of which figures you've bought, and which one you still need. COMPLETE LISTINGS of all Ral Partha's thousands of fantasy figures are contained in the 1986 *Fantasy Catalog*. Send for yours today! It costs \$2.00, but comes with a handy Redemption Coupon good for \$2.00 off your first order.

MAIL ORDERS: For mail orders under \$30.00, please add \$2.00 postage and handling. Orders \$30.00 and over are postpaid. Sorry, we can't accept C.O.D. orders!

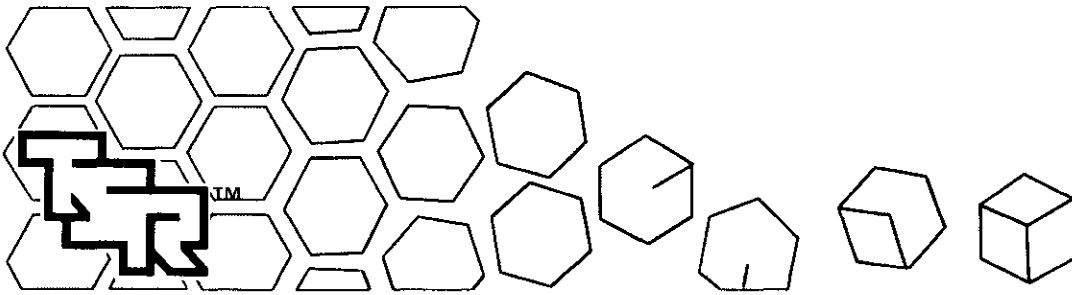

P R E V I E W S

NEW PRODUCTS

FOR OCTOBER 1986

DA1 Adventures in Blackmoor™ Module D&D® Game Adventure by Dave Arneson

The co-creator of the DUNGEONS & DRAGONS® game returns to his roots with the first of a series of adventures set in the strange country of Blackmoor.

In the realms of Blackmoor, crude technology battles the schools of magic, while mysterious forces from the north threaten the civilized lands. This adventure contains a full-size color map and a detailed source-book of the lands.

And watch for DA2, *Temple of the Frog*, in January 1987.

**Product No. 9172
Suggested Retail Price: \$10.00**

I10 RAVENLOFT II: GRYPHON HILL AD&D® Game Adventure by Tracy and Laura Hickman

The Master of Ravenloft is having guests for dinner . . . and once again, you're invited.

In this thrilling sequel to I6, *Ravenloft*, Count Strad von Zarovitch has moved to a far country in search of new blood to quench his undying thirst . . . and to pave the way for rulership of the world. Who will stop him this time? Volunteers, anyone?

**Product No. 9181
Suggested Retail Price: \$8.00**

MH9 GATES OF WHAT IF? MARVEL SUPER HEROES™

Game Adventure

by Roger Moore

Venture into an alternate dimension with the Fantastic Four™ and Spider Man™ . . . where the greatest hero is a man known as Victor™, ruler of Latveria™. This exciting What If?™ adventure is a major challenge for your top superheroes. Excelsior!

**Product No. 6867
Suggested Retail Price: \$8.00**

All Marvel characters, character names, and the distinctive likenesses thereof, are the trademarks of the Marvel Comics Group. MARVEL SUPER HEROES is a trademark of the Marvel Comics Group. Copyright ©1986 Marvel Comics Group, a division of Cadence Industries. All Rights Reserved.

LORDS OF DOOM:

**A DRAGONLANCE® Adventure
AD&D® Adventure Gamebook #10
by Douglas Niles**

Join Silvara and Gilthanas as they penetrate to the heart of the Dragon Highlord's realm . . . the forbidden city of Sanction. There, they must learn the evil secret of the draconians and then escape the wrath of the Dragonarmies!

**Product No. 8960
Suggested Retail Price: \$2.95**

AGENT 13™ AND THE ACOLYTES OF DARKNESS

**AGENT 13™ Book #3
by Flint Dille and David Marconi**

Continuing the thrilling action saga of AGENT 13™!

The incredible superagent hears of a potion that will allow members of the Brotherhood to extend their lives far into the future. Will he destroy it, take it for himself, or is it too late to do either?

**Product No. 8402
Suggested Retail Price: \$2.95**

AGENT 13™ & ©1986 Flint Dille and David Marconi and TSR, Inc.

CLAW OF THE DRAGON

**ENDLESS QUEST® Book #34
by Bruce Algozin**

Barnaby and the orphan Smudge must undertake a dangerous journey to Death's Head to deliver the Claw of the Dragon to the dragon king . . . or else war will break out!

**Product No. 8534
Suggested Retail Price: \$2.25**

NEW PRODUCTS

FOR SEPTEMBER 1986

GW6 ALPHA FACTOR GAMMA WORLD® Game Adventure by Kim Eastland

The first of a GAMMA WORLD® campaign series!

You have joined the Restoration Council, a group dedicated to rebuilding civilization. Your party must travel across the ruined country to seek the artifacts that are needed for the Council's work.

But first, you must cross the deadly Burning Lands and the Lip of Despair to recover the memory core of the greatest computer of the ancient world. . . .

**Product No. 7509
Suggested Retail Price: \$10.00**



P R E V I E W S

DRAGONLANCE® Legends, Volume 3

Test of the Twins
by Margaret Weis

and Tracy Hickman

Caramon returns to his own time, only to find Krynn in ruins and Astinus about to close the Great Book. He knows then that Raistlin has succeeded in his evil quest. To defeat him, Caramon and Tasslehoff must descend into the Abyss himself, face the Queen of Darkness, and make certain his brother never leaves. . . .

The final volume of the DRAGONLANCE® Legends series.

Product No. 8309

Suggested Retail Price: \$3.95

BOXED GIFT SET of Vols. 1-3

Product No. 8313

Suggested Retail Price: \$11.85

GDQ1-7 QUEEN OF THE SPIDERS

AD&D® Game Supermodule

Weary from their long campaign against the Slavelords, the original adventurers from T1-4 (*Temple of Elemental Evil*) now must face a new and even more frightening menace: a revolt among the giants of the Drachensgrab Mountains. And from that campaign, they discover that the evil drow elves are once again menacing the surface world . . . and behind the drow is the sinister Lolth, Demon Queen of Spiders!

This new edition of the famous "G," "D," and "Q" modules has been developed and brought up to date, and linked together with T1-4 and A1-4 into a massive single campaign in the WORLD OF GREYHAWK™ Fantasy Game Setting.

Product No. 9179

Suggested Retail Price: \$15.00

19 DAY OF AL'AKBAR

AD&D® Game Adventure

by Allen Hammack

A deadly plague sweeps the desert lands. Only the legendary talisman of Al'akbar, hidden deep within the tomb of the Sultan Amwara, can cure the ill and lift the curse from the land . . . but deadly traps and perilous pitfalls guard this ancient artifact.

A module for character levels 10-12.

Product No. 9178

Suggested Retail Price: \$8.00

BATTLE ROAD

CAR WARS™ Gamebook #1

by Steve Jackson

Welcome to the world of 2035 . . . where adventure is everywhere and the right-of-way goes to the car with the biggest guns.

Steve Jackson, creator of the CAR WARS™ game, now enters the world of gamebooks with the first of a series of exciting solo adventures. The daughter of the President of Louisiana has been taken hostage. Can you drive in alone, rescue her, and get out alive?

Product No. 8014

Suggested Retail Price: \$2.95

CAR WARS™ & ©1986 Steve Jackson Games.

The AMAZING SPIDER-MAN™

in **CITY IN DARKNESS**

MARVEL SUPER HEROES™

Gamebook #1

by Jeff Grubb

The first of a new gamebook line by the creator of the MARVEL SUPER HEROES™ role-playing game!

Take on the role of Spider-Man™ as you try to uncover and defeat the sinister mastermind behind a plot to plunge Manhattan into darkness!

Product No. 8021

Suggested Retail Price: \$2.95

CAPTAIN AMERICA™

in **ROCKETS' RED GLARE**

by Kate Novak

Terrorists threaten to destroy the American way of life — unless Captain America™ can halt the violence!

Product No. 8022

Suggested Retail Price: \$2.95

All Marvel characters, character names, and the distinctive likenesses thereof, are the trademarks of the Marvel Comics Group. MARVEL SUPER HEROES is a trademark of the Marvel Comics Group. ©1986 Marvel Comics Group, a division of Cadence Industries. All Rights Reserved.

WARLORDS:

An Oriental Adventures Gamebook

ONE-ON-ONE™ Adventure

Gamebook #7

by David "Zeb" Cook

Prince Sato Matabei, banished son of the deposed Warlord, must battle the Sato Ken-shin, usurper of the throne, with armies of samurai and ninja on every side!

A ONE-ON-ONE Adventure Gamebook for two-player role-playing.

Product No. 8467

Suggested Retail Price: \$5.95

Unless otherwise noted:

® denotes registered trademarks owned by TSR, Inc.
™ denotes other trademarks owned by TSR, Inc.

Copyright ©1986 TSR, Inc. All Rights Reserved.

P R E V I E W S

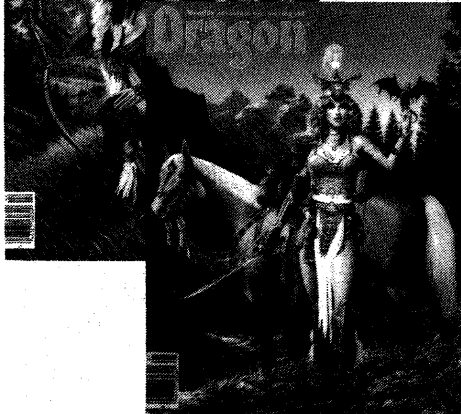

Are you missing

a DRAGON[®] magazine

in your lair?

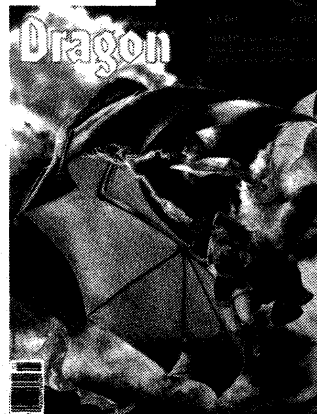

Well, a limited number of back issues of DRAGON[®] Magazine is available through The Mail Order Hobby Shop. Or, if you've been searching in vain for that special article that appeared in the now out-of-print issues of DRAGON Magazine, our Best Of DRAGON[®] volumes might fill your need.

Just take a look at the list below, then check the lines of those issues you'd like to order. If you want more than one copy of a specific issue, write the number of copies on that issue's line.

These offerings are priced at \$3.00 each (except for all issues after #105, which cost \$3.50, and the Best of DRAGON[®] anthologies); payment in U.S. funds **only**. Be sure to add shipping and handling charges. Then, complete and mail the order form below.

(Please PRINT all information plainly)

Name _____

Address* _____

City _____

State/Prov. _____ Zip _____

Country _____

Date _____

* Please use street address, not a P.O. Box number.

Check one to indicate your choice of payment

- Check enclosed MasterCard*
 Money order enclosed VISA*

* **Minimum credit card order: \$15.00 No exceptions, please.**

Name to which credit card is issued _____

Credit Card No. _____

Expiration Date _____

Signature of the person to whom credit card is issued _____

Allow four to six weeks for delivery.

DRAGON is a registered trademark owned by TSR, Inc.

© 1986 TSR, Inc. All Rights reserved.

ISSUES AVAILABLE

DR112

- | | | |
|--------|--------|---------|
| — # 71 | — # 88 | — # 100 |
| — # 73 | — # 89 | — # 101 |
| — # 74 | — # 90 | — # 102 |
| — # 76 | — # 91 | — # 103 |
| — # 79 | — # 92 | — # 104 |
| — # 81 | — # 93 | — # 105 |
| — # 82 | — # 94 | — # 106 |
| — # 83 | — # 95 | — # 107 |
| — # 84 | — # 96 | — # 108 |
| — # 85 | — # 97 | — # 109 |
| — # 86 | — # 98 | — # 110 |
| — # 87 | — # 99 | — # 111 |

Best Of DRAGON[®] anthologies

- Volume I (\$3.95)
 — Volume II (\$3.95)
 — Volume III (\$3.95)
 — Volume IV (\$4.50)
 — Volume V (\$4.50)

Subtotal of all magazine costs	\$
Illinois & Wisconsin residents, add 5% sales tax	\$
Shipping & handling, regardless of number of magazines	\$ 4.50
TOTAL AMOUNT DUE	\$

**MAIL TO: The Mail Order Hobby Shop, P. O. Box 756, Lake Geneva WI 53147.
 Make checks or money orders payable to: The Mail Order Hobby Shop.**

The DRAGON[®] Magazine

Ultimate Article Index

Ten years of articles, advice, monsters, and magic

Compiled by Jean and Wally Black, edited by Kim Mohan

Welcome to the DRAGON[®] Magazine Ultimate Article Index. It isn't the first index we've ever published in DRAGON Magazine, but with any luck at all it will be the last.

No, that doesn't mean we're never going to index all our future issues. What it means is that, from now on, we expect to be able to simply update the Ultimate Article Index with yearly or year-and-a-halfly supplements. The information contained on these pages will be just as accurate in 1996 as it is in 1986, and the classification system is so comprehensive that we aren't going to consider messing with it — we're just going to keep adding pieces, so that you'll always be able to have a complete article index by holding onto these pages and collecting the supplements.

The Ultimate Article Index was designed and compiled by Jean Blashfield Black, who in real life is the head of TSR's book publishing division. She has professional experience in this sort of thing — and, believe it or not, she says she actually enjoys indexing. (well, at least she said that before she started on this one. . . .) She and her husband Wally leafed through ten years' worth of magazines, typing out titles and coming up with categories until the wee hours of many a morning.

Then the index went into production, which is similar to the process of putting a steak through a meat grinder: What comes out is essentially the same as what went in, but it gets softened up a bit so that it can be manipulated to fit into a certain amount of space. In this case, we had roughly 25 pages of text that needed to be squeezed into 19 pages of space. By dropping a few of the more esoteric categories and consolidating some entries that could appear under the same heading instead of slightly different ones, we managed to make it fit into the space we could afford for it.

What's in here. . .

We made some fundamental decisions on the approach and content of the index before Jean and Wally went to work. We didn't intend to try to index *everything* that has ever been published; we knew right away that we couldn't afford to spend the number of pages that a completely complete index would take up.

What we tried to do was include any article, or part of an article, that has relevance to a game and that we expected someone would want to look up for reference or research purposes. If an article was determined to have lasting significance (admittedly a subjective judgment), we included it; if it didn't seem like the sort of thing someone would have any use for in this day and age, we reluctantly left it out.

The index contains two kinds of primary entries: article titles and topic headings. Titles are printed in boldface type, followed by the subtitle (if any), author's name, and issue number in regular type. Of course, titles do not include "A," "An" or "The" when one of those was the first word of the title; for instance, "The Role of Nature" (issue #108) is listed under "R" for "Role." Every article that qualified for inclusion is represented by at least a title entry, and often it also appears under one or more topic headings.

Topic headings are useful for two purposes. If you remember what an article was about, but don't recall the exact title, try looking for it under an appropriate topic heading. For instance, the article on the sentinel NPC appears in the "H" section because that's the first letter of the title. But we don't expect you to remember what it was called, so you can also find it under the topic headings "Sentinel NPC" and "Non-player character," both of which give the article's title and the issue number in which it appears. Then, if you want to check back to find out who wrote it, you can look up the title entry.

The second useful purpose is to find out how many articles have appeared on a certain subject. If you want to check out everything we've printed that is primarily concerned with elves, look under "Elf." Somewhere in the neighborhood, you'll also find every article title that begins with "Elf" or "Elves" or something like that. Sometimes an article will not be listed under an appropriate topic heading when it also appears listed by title in close proximity to that heading, which is one way we avoided redundancy and got the index cut down to a manageable size. Also, take note of the word "primarily" used a few lines back. The topic heading "Elf" does not mention every article in which the word "elf" appears, only those articles that deal mainly or exclusively with elves.

. . . And what's not

No index introduction would be complete without an apology for what we didn't include, so —

Here's what we didn't include: reviews of games, reviews of modern literature, fiction, humor, character descriptions taken from modern literature, and lots of other particular articles and features that we didn't expect anyone to have any use for (see the preceding section of text).

And here's the apology: Sorry, folks. If we had unlimited time to compile and produce the text, and unlimited space to print it, maybe we would have done more. But we didn't, so we didn't.

If you run across an error of omission that you think is significant, drop us a line and let us know about it. If we agree that it's an error, and not an intentional omission, we'll let everyone else know about it in a future issue. Also, if you have any suggestions for minor changes to the style and format of the index, our mailbox is always open. We aren't going to rip this index down to its foundation and start over, as we've done in the past, but we are open to ideas on how to make the updates easier to use in case there's something we've overlooked.

Some things never change

Finally, we have to say the same thing we've said every time we've published an index. Although this compilation goes all the way back to issue #1, you all should realize that around three-fourths of the issues we've published are out of print and not available for sale as back issues. Please don't write in to say that you just *have* to get a copy of issue #26, or a copy of an article from that issue. We can't honor requests like that, so all you're going to do is waste a stamp and make us feel guilty.

The back issues that are for sale through TSR's mail-order department are listed on the order blank in every issue of the magazine. If we don't have what you want, all is not necessarily lost. You might be able to find an out-of-print issue for sale (probably at much more than cover price) in a hobby shop. You might be able to locate the issue you need by putting an ad in your local newspaper — and dig up a new playing companion at the same time. Old issues are often for sale at auctions, especially at the larger game conventions. In short, there are ways to get your hands on an old issue, but it won't be easy and it probably won't come cheap.

Enjoy the index for the good it can do you, instead of getting frustrated over what it can't do. Even if you've only got three or four years' worth of magazines, you've probably spent a lot of time flipping pages to find an old article that you *know* is in the stack somewhere. If the Ultimate Article Index helps you find what you want faster than you could find it by flipping, then it will have fulfilled its purpose. From now on, all you have to remember is what issue the index is in.

Abigor, Duke of Hell, 76

Abilities

- Combat Modifications for Dexterity, table, 3
- Demi-humans Get a Lift, 95
- Making Charisma Count for More, 63
- Short Hops and Big Drops, 93
- Singing a New Tune, 56
- Six Main Skills, 107
- Strength Comparison Table, 26
- You Can Jump How Far? OK, Prove It!, 25

Chess modifier

- Game within a Game, 70
- Optimal system of determining**
So, You Want Realism in D&D?, 8

Abilities, scores

- probability table, 39
- Room for Improvement, 107

Abilities, table

- How to Use Non-Prime-Requisite Character Attributes, 1

Abishal, lesser devil, 75

Aboriginal mythos

- Mythos of Australia in DUNGEONS & DRAGONS, 19

Acrobat

- Character Classes to Consider, 65
- "Split Class" for Nimble Characters: Thief-Acrobat, 69

Action in the Melee Round by Len Lakofka, 43

Active Duty: Continuing careers in TRAVELLER gaming, by Jefferson P. Swycaffer, 102

AD&D, comparison to D&D

- Melee in D&D, 24
- AD&D, conversion to BOOT HILL**
Six Guns & Sorcery, 28
- AD&D, what's official**
Poker, Chess and the AD&D System, 67

AD&D adventure

- Aesirhamar, 90
- Assassins' Run, 64
- Barnacus: City in Peril, 80
- Betrayed, 105
- Can Seapoint Be Saved?, 75
- Cavern Quest, 54
- Chagmat, 63
- Citadel by the Sea, 78
- City Beyond the Gate, 100
- Dancing Hut, 83
- Doomkeep, AD&D Masters Tournament, 34
- Fedifensor, 67
- Forest of Doom, 73
- Garden of Nefaron, 53
- Gypsy Train, 93
- House in the Frozen Lands, 110
- Into the Forgotten Realms, 95
- Mansion of Mad Professor Ludlow, 42
- Mechica, 70
- Pit of the Oracle, 37
- Quest for the Midas Orb, 61
- Ruins of Andril, 81
- Slave Pits Revisited, 49
- Survival Tips for the Slave Pits, 43
- Temple of Poseidon, 46
- Twofold Talisman, Adventure One: Heart of Light, 84
- Twofold Talisman, Adventure Two: The Ebon Stone, 85
- Valley of the Earth Mother, 102
- Wandering Trees, 57

AD&D exam

- Don't Just Think about It . . . Take the AD&D Exam, 47

AD&D in science-fiction setting

- Dwarves in Space, 70

AD&D's Magic System: How and Why It works by Gary

- Gygax, 33

Adamantite

- Short History of Adamantite, 17

Adding Depth to the Flanaess by Len Lakofka, 52

Administrator's Advice: How to make and maintain a TOP SECRET campaign, by John J. Terra, 109

Adonides, Duke of Hell, 76

Adramalech, Chancellor of Hell, 76

ADVANCED DUNGEONS & DRAGONS, see AD&D

Advanced Illusion & Philosopher's Stone by G. Gygax, 59

Advanced Illusion, illusionist spell, 66

Adventuring with Shaky Hands in "Up on a Soapbox", by

- Judith Sampson, 53

Aerdrie Faenya, lesser goddess

- Gods of the Elves, 60

Aerial mounts, table

- Ups and Downs of Riding High, 50

Aesirhamar: An AD&D adventure for high-level characters, by Roger Moore, 90

African mythos

- Mythos of Africa in DUNGEONS & DRAGONS, 27

After the Blast: In case it matters, how to play out bomb effects, by Roger Moore, 98

Agares, Duke of Hell, 75

Agencies and Alignments: The varied groups of the TOP SECRET game, by Merle Rasmussen, 93

Agents and A-bombs: Nuclear devices in TOP SECRET game play, by Thomas M. Kane, 108

AGINCOURT: Designer's Notes, by James Dunnigan, 27

Political and Military Effects of Agincourt, 27

Aging in D&D, by Mike Crane, 29

Air, god, 77

AIR WAR: North Vietnam, by J. D. Webster, 29

Aklys

- New Weapons from Another "Great Mind", 64

Alarm, magic-user spell, 67

Alchemist

- Living in a Material World, 81
- New D&D Character Class: The Alchemist, 2
- NPCs for Hire, 45
- Recipe for the Alchemist, 49

Alcor by Michael Persinger, 101

Alignment

- Alignment: A New View of the Nine Philosophies, 80
- Another View of the Nine-Point Alignment Scheme, 26
- Choir Practice at the First Church of Lawful Evil, 24
- Clerics Must Be Deity-Bound, 85
- Deities and Their Faithful, 97
- Evil: Law vs. Chaos, 28
- For King and Country, 101
- Good isn't Stupid, Paladins & Rangers, etc., 38
- How to Have a Good Time Being Evil, 45
- It's Not Easy Being Good, 51
- Neutral Point of View, 99
- Varied Player Character & Non-Player Character Alignment, 9

Alignment: A New View of the Nine Philosophies, by John Lees, 60

Alignment language

- Language Rules Leave Lots of Room for Creativity, 66

All about Elminster: Or, to be more precise, everything he's willing to let us know, by Ed Greenwood, 110

All about Gully Dwarves: Grubby and goofy, but lovable just the same, by Roger Moore, 102

All about Kryn'n's Gnomes: The smallest and rarest demi-humans of all, by Roger Moore, 103

All about the Druid/Ranger: A classy explanation, better late than never, by Frank Mentzer, 100

All about the Kender: A long look at the little people of Kryn'n, by Roger Moore, 101

All Fighters are not Created Equal, by George Pazolt, 41

All for All, Not One for One: Selfish motives have no place in gaming, by Roger Moore, 73

All Games Need Names: But don't make a game out of naming! by Katharine Kerr, 75

All Good Things Must End . . . : Deadly determinations for an AD&D character's fate, by Len Lakofka, 31

All This and World War 8, in "The MARVEL-Phile" by Jeff Grubb, 104

Allosaurus, 55

Alocer, Duke of Hell, 75

Alone Against the Asteroid: The ASTEROID game, solitaire, by Stephan James, 98

Alpha and Omega, Part I, in "The MARVEL-Phile", by Jeff Grubb, 106

Alpha and Omega, Part II, in "The MARVEL-Phile", by Jeff Grubb, 107

ALPHA OMEGA

- Will Jason Destroy the Dragonship? Stay Tuned. . . ., 31

Alter Self, illusionist spell, 66

Alternate Beginning Sequence for METAMORPHOSIS

ALPHA, by Guy W. McLimore, Jr., 6

Amazon by Roger Moore, 43

Amduscias, Duke of Hell, 75

Amitok by Roger Moore, 89

Amon, Duke of Hell, 75

Amulet of Protection from Sleep by Richard Lucas, 91

Amulet of Psionic Reflection by Roger Moore, 99

Amulet of Sleeplessness by Richard Lucas, 91

Anatosaurus, 55

And a Few Words from the Author, interview with Gary Gygax, 28

And Now, the Psionicist: A class that moves psionics into the mainstream, by Arthur Collins, 78

And Then There were Three: Companion takes D&D game to even higher levels, by Frank Mentzer, 84

And What of the Skinnies?: A STARSHIP TROOPERS variant, by John W. S. Marvin, 28

Angels, by William Fawcett, 35

Messengers of God, 17

psionic powers, letter, 43

Angur-Boda, Norse figure, 110

Anhkheg, 5

Animal skeletons

- New Monsters for Low Levels, 66

Animals

- Cast of Strange Familiars, 84
- Wolf in Your Paint Pot, 40

Ankylosaurus, 55

Another Look at Lycanthropy by Jon Mattson, 24

Another Look at Witches and Witchcraft in D&D by Ronald Pehr, 20

Another View of the Nine-Point Alignment Scheme by Carl Partagreto, 26

Anti-Paladin NPC: Good got you down? Try this for Evil, by George Laking and Tim Mesford, 39

Antidotes, tables

- Poison, 81
- Taking the Sting out of Poison, 81

Antimissiles and Roundshot: Variant ship-to-ship weapons for TRAVELLER gaming, by Jeff Swycaffer, 95

Apatosaurus, 55

Apes

- Many Shapes of the Apes, 95

Apollyon

- Demons, Devils and Spirits, 42

Apparatus of Spikey Owns, 28

Appendix to "Adding Depth to the Flanaess," by Gary

- Gygax, 52

Apples, Oranges, Role-Playing and Morality in "Up on a Soapbox" by Larry DiTillio, 43

Aquatic Encounters with Megafloora by George Laking, 32

Aquatic monsters

- What's That In The Water?, 68

Arack dragon

- Landragons, 74

Arbane's Sword of Agility in "Bazaar of the Bizarre" by Ed Greenwood, 41

Arcana Update, Part I: Repairs, reasons, and even more new rules, by Kim Mohan, 103

Archdevils, 91

Archer NPC

- Weapon Specialization, 66
- Missile Fire and the Archer Subclass, 45

Archers, in the Astral Plane

- Sage Advice, 71

Argas by James Hopkins II, 53

Ariel, character description, 52

Arioch, Duke of Hell, 75

Armada Disasters by Lynn Harpold, 25

Armaros, Greater Devil, 91

Armies of the Renaissance by Nick Nascati

- Part I, 22
- Part II - The Swiss, 24
- Part III - Condottiere and the Papacy, 25
- Part IV - The English, 28
- Part V - Eastern Europe, 30
- Part VI - Landsknecht and Reiters, 37

Armor

- Armor of the Far East, 31

History of the Shield, 57

It Weighs What?, 23

Keep Track of Quality, 65

Warhorses and Barding, 74

Armor, dragon

- Evil Dragon Armors, 62

Armor, magic-user spell, 67

Armor of Acidic Secretion by Gregory Detwiler, 99

Armor of the Far East by Michael Kluever, 31

Armorer training

- Working Your Way up to First Level, 51

Armory

- Understanding Armory, 53

Arms and Armor of the Conquistadores by Michael H. Kluever, 25

Amy Travels on Its Stomach: Large-scale logistics in a fantasy world, by Katharine Kerr, 94

Arrikhan

- Plethora of Paladins, 106

Arrow of Charming by David Baldwin, 91

Arrows of Conscientious Objection

- Nasty Additions to a DM's Arsenal, 77

Art of Good Generalship in "Up on a Soapbox", by Terry L. Ford, 41

Artifacts of Dragon Pass: Six magic items to give added meaning to RUNEQUEST, by Jon Mattson, 40

Aruchai

- Creatures from Elsewhere, 47

Anvoren

- Gods of the Halflings, 59

Ascomoid, 68

Asimov Cluster by William Fawcett, 20

Assassin
 Handy Art of Forgery, 96
 Assassins' Guild, 64
 First Assassins, 22

Assassins' Guild by Elizabeth Cerritelli, 64

Assassins' Run by Ed Greenwood, 64

Assessing, Not Guessing: How PCs can make their own value judgments, by Lionel D. Smith, 104

Astaroth, character description, 28

ASTEROID
 Alone Against the Asteroid, 98

Astral Plane by Roger Moore, introduction by Gary Gygax, 67
 Sage Advice, 71
 see also Campaign design: Setting

Astrologer
 NPCs for Hire, 45

Atlatl
 New Weapons from Another "Great Mind", 64
 Or With a... Weird One, 61

Attack damage by dragons, table
 Dragon Damage Revised, 98

Attack matrix, table
 New Charts, Using the "5% principle", 80

Attack Priority System
 Who Gets The First Swing?, 71

Auctions aren't Forbidding: Who and what to expect, by Tim Stabosz, 98

Australian myths
 Mythos of Australia in DUNGEONS & DRAGONS, 19

Authentic Agencies, part I: Real facts and figures for TOP SECRET play, by Merle M. Rasmussen, 97

Authentic Agencies, part II: More real-world outfits for TOP SECRET play, by Merle and Jackie Rasmussen, 98

Authentic Agencies, part III: Pulling back the curtain on the KGB, by Merle and Jackie Rasmussen, 99

Automaton by Alex Gray, 101

Avari by Scott Bennie, 101

Avengers, in "The MARVEL-Phile" by Jeff Grubb, 93

Avernus, plane of the Nine Hells, 75

Avoidance, magic-user spell, 68

AWFUL GREEN THINGS FROM OUTER SPACE
 Board game by Tom Wham, 28
 Outside the Znutar, game expansion, 40

Ay PronunseeAYshun Gyd: An informal index of the right things to say, compiled by Frank Mentzer, 93

Azazel, greater devil, 91

Aztec Empire
 War of Flowers, 25

Baalpegor, Princess of Hell, 76

Babylonian gods
 Near Eastern Mythos, 16

Back in the U.S.S.R. in "The MARVEL-Phile" by Jeff Grubb, 99

Bad Idea, Good Game?: Yes, it can happen-but not all the time, by Michael Dobson, 106

Bael, Duke of Hell, 75

Baervan Wildwanderer
 Gods of the Gnomes, 61

Baflis, Princess of Hell, 76

Bag of Wind, 27

Bagh-Nakh
 Or With A... Weird One, 61

Bahamut, King of Good Dragons
 Dragons and Their Deities, 86
 Rearranging and Redefining the Mighty Dragon, 38

Bahgru
 Gods of the Orcs, 62

Baku by Gary Gygax, 65

Balan, Duke of Hell, 75

Bandit Kingdoms
 Greyhawk's World, 63
 Protection Circles and the Like, 56

Bandits!: A shifty character for your campaign, by Tom Armstrong and Roger Moore, 63

Banishment, magic-user spell, 68

Barbarian
 Barbarian Cleric, 109
 Big, Bad Barbarian, 63
 Character Classes to Consider, 65
 Loyal Readers: EGG answers letters, 67
 Poker, Chess and the AD&D System, 67
 Real Barbarians, 72

Barbarian Cleric: No tribe is complete without one of these, by Thomas M. Kane, 109

Barbarian North and the Youth of Juulute Wolfheart, in "Minarian Legends" by Glenn Rahman, 39

BARBARIAN PRINCE
 Beg, Borrow or Steal?, 68

Barbas, Duke of Hell, 76

Barbatos, Duke of Hell, 76

Bard
 Gypsies, 59
 in Sage Advice, 56
 Singing a New Tune, 56

Bare-handed combat
 Without Any Weapons, 61

Barghost, 26

Barlithian's Mystical Mirror in "Bazaar of the Bizarre", by Mark Corrington, 50

Barnacus: City in Peril, AD&D adventure for 1st-5th levels, by Frances Nontel, 80

Basic Bureaus and Special Agents in "The Rasmussen Files", by Merle Rasmussen, 47

Basic D&D Points of View . . . From Editors Old & New by Tom Moldvay, 52

BASIC Program to Calculate Chi-square Values, 78

Basidiron, 68

Basilisk
 Ecology of the Basilisk, 81

Bathym, Duke of Hell, 75

Baton Races of Yaz: A silly boardgame, by C. C. Stoll, 82

Bats That Do More Than Bite: Six species from Elminster's latest lecture, by Ed Greenwood, 90

Battle of Ebony Eyes: a STAR FRONTIERS Knight Hawks game adventure, by William Tracy, 88

Battle of Five Armies in Miniature by Larry Smith, 1

Battle of the Temple of Chanis: 2020 A.G., by M.A.R. Barker, 4

Battles, D&D
 War Machine Revisited, 109

Battles, in fantasy
 Fights of Fantasy, 79

Battles above the Dungeon: Basic combat tactics for the wide-open spaces, by Tim W. Brown, 95

BATTLESYSTEM
 Chance of a Lifetime, 100
 Three Challenges in One, 104

Bazaar of the Bizarre, 27,28,29,33,37,39,40,41,45,47, 48,50,54,58,62

Be a Creative Game-Player in "Up on a Soapbox", by Kristan Wheaton, 45

Be a Two-Fisted Fighter by Roger Moore, 68

Be Aware and Take Care: Basic principles of successful adventuring, by Lew Pulsipher, 79

Be Thy Die Ill-Wrought?: Only those that pass the chi-square test can play, by D. G. Weeks, 78

Beard, dwarven
 Worth Its Weight in Gold, 109

Bearded devils, 75

Beefing up the Bureaus: Suggestions for giving agents separate skills, by Mike Beeman, 89

Beefing up the Cleric by Len Lakofka, 58

Beetle, Killer by Ed Greenwood, 89

Before the Dark Years: The timeline of the GAMMA WORLD game universe, by J. Ward and R. Moore, 88

Beg, Borrow or Steal?: Six ways to aid Cal Arath's cash flow, by Glenn Rahman, 68

Beholder
 Ecology of the Beholder, 76

Belabra by Ed Greenwood, 94

Bele, Duke of Hell, 76

Belial, Arch-devil, 75

Belial, character description, 28

Believe It or Not, Fantasy has Reality by D. Bachman, 40

Bell of Pavlov by Robert Plamondon, 45

Beltar, Suel god, 89

Bensozia, Duke of Hell, 76

Beowulf, character descriptions
 Three Cheers for Beowulf, 85

Bergenhone '77: the CAT's Test of American Armor! by Stanley Schreifer, 24

Berserker
 New D&D Character Subclass: The Berserker, 3

Best Wishes!: Guidelines for getting and giving, by Gary Snyder, 49

Betrayed: An AD&D game adventure for characters of levels 3-5, by Jim Bengston, 105

Betta, Giant by Matthew Quinn, 94

Beware of Quirks and Curses: Magic items aren't always nice, by Tom Holsinger and Candy Peterson, 34

Beware of Traps in Woods by Tom Armstrong, 52

Beware the Jabberwock by Mark Nulver, 54

Beyond the Dungeon, Part 1: How to cope in the greatest adventure of all, by Katharine Kerr, 87

Beyond the Dungeon, Part 2: Moving a campaign into the great outdoors, by Katharine Kerr, 88

Beyond the Rule Book: Procedure and style tips for good GMing, by Lew Pulsipher, 75

Bhaergala by Ed Greenwood, 94

Bichir by Ed Greenwood, 89

Biffant, Duke of Hell, 75

Bifrons, Duke of Hell, 76

Big Guns: The armed forces in the MARVEL SUPER HEROES game, by William W. Goodson, Jr., 105

Big, Bad Barbarian by Gary Gygax, 63

Bileth, Duke of Hell, 76

Bilge Rat and the Mercenary Fleets of Minaria in "Minarian Legends", by Glenn Rahman, 48

Bind, magic-user spell, 67

Binding, magic-user spell, 68

Bionic Supplement by Brian Blume, 13

Birth Tables and Social Status by Glenn Rahman, 26

Birth Tables for BOOT HILL by Stephen Blair, 18

Birth Tables for D&D by Brad Stock and Brian Lane, 3

Birthplace tables, in Greyhawk
 Adding Depth to the Flanaess, 52

Bist, greater devil, 75

Bitru, Duke of Hell, 75

Black Hand in "Minarian Legends", by Glenn Rahman, 46

Black Holest by James Hopkins, 35

Black Knight in "Minarian Legends" by Glenn Rahman, 44

Blackjack
 Or With A... Weird One, 61

Blades with Personality: DM's planning can produce distinctive swords, by Sam Chupp, 109

Blame It on the Gremlins: Militaristic mischief-makers, by Gregg Chamberlain, 79

Blastoff!: The work is done - now comes the fun, by Steve Winter, 65

Bleeder by Ed Greenwood, 59

Blongun
 New Weapons from Another "Great Mind", 64
 Or With A... Weird One, 61

Blueprint for a Big Game: How to accommodate a world's worth of players, by Jim Dutton, 97

Blueprint for a Lich: Vampire's blood, belladonna and a virgin's heart well simmered, by Len Lakofka, 26

Boats
 Hull Truth about Speed, 70

Boccob, Greyhawk deity, 70

Bodvar Bjarki, character description by Tom Moldvay, 39

Bogatyr of Old Kiev by David Nalle, 53

Bogeyman by Gregg Chamberlain, 101

Boggart by Roger Moore, 54

Bohun Tree by Ed Greenwood, 89

Bola
 Or With A... Weird One, 61

Bolotomus' Revenge, or, It's more than just a playing surface, by Glenn Jarrell, 34

Bond, James
 In Search of a James Bond, 57

Books are Books, and Games are Games, and Never the Twain . . . by Gary Gygax, 31

Books to Games? Perhaps!: Using literature as the backdrop for adventuring, by Arn Ashleigh Parker, 96

Boomerang
 Or With A... Weird One, 61

BOOT HILL
 Birth Tables for BOOT HILL, 18
 BOOT HILL Additions, Revisions, and Trivia, 26
 BOOT HILL Encounter Chart, 21
 BOOT HILL? Sure! But What Scale?, 30
 Cash & Carry For Cowboys, 54
 Fastest Guns that Never Lived, Parts I-IV, 36
 Fastest Guns that Never Lived, Part II, 9
 Fastest Guns that Never Lived, Part III, 19
 How to Ease the BOOT HILL Identity Crisis, 46
 Let Your Town Have a Purpose, 18
 Random Encounters for BOOT HILL, 15
 Saved by the Cavalry!, 76
 This Here's Tyrannosaurus Tex, 46

character conversion to AD&D
 Six Guns & Sorcery, 28

BOOT HILL Additions, Revisions, and Trivia by Michael Crane, 26

BOOT HILL adventure
 The Taming of Brimstone, 71

BOOT HILL Encounter Chart or, What to do between bank jobs, table, by Robert Wagner, 21

Boredom and the Average D&D Dungeon by James M. Ward, 17

Boris, story and photos by Bryce Knorr, 52

Bottle of Undead by Bruce Sears, 54

Bounty hunter
 Beware of Traps in Woods, 52
 He's on Your Trail, 52
 Not a Very Nice Guy, 52

Bow of Doubling by Stephen Martin, 99

- Bows:** Of staves and strings and other things, by William Fawcett, 39
- Bows and arrows**
Missile Fire and the Archer Subclass, 45
Mystery of the Bow, 35
- Box of Many Holdings** by John Beck, 45
- Bracers of Attraction** by Bill Birdsall and Bob Reitmann, 91
- Bracers of Deflection** by Michael Persinger, 99
- Bracers of the Merman** by Roger Moore, 91
- Brachiosaurus**, 55
- Bralm, Suel god**, 92
- Brandobaris**
Gods of the Halfings, 59
- Brawling:** The Easy Way "Out" in D&D, by Rob Kuntz, 11
- Breath weapons, dragons**
True Dragons, 50
- Brewing up a New NPC:** The witch, by Bill Muhlhausen, 43
- Buer, Duke of Hell**, 76
- Buildings, in ruined city, fable**
Ruins, 54
- Buleffe** (a.k.a. Landshark), 1
Ecology of the Bulette, 74
- Bullwhip**
Or With A . . . Weird One, 61
- Bune, Duke of Hell**, 76
- BUNNIES AND BURROWS**
Hop, Hop, Hooray!, 45
- Burbur** by Ed Greenwood, 101
- Bureaucrats and Politicians** by Len Lakofka and Brad Nystul, 74
- Bush dog**
Collection of Canines, 102
- . . . **But not least: The Humanoids:** Goals and gods of the kobolds, goblins, hobgoblins, & gnolls, by Roger Moore, 63
- Caarcinolaas, Duke of Hell**, 75
- Cahor, greater devil**, 91
- Caim, greater devil**, 75
- Caina, plane of the Nine Hells**, 76
- Calendar**
Merry Month of . . . Mirtul?, 47
- Caliban, character description**
Island Enchanters, 52
- Callfrop**
New Weapons from Another "Great Mind", 64
Or With A . . . Weird One, 61
- Calygraunt** by Ed Greenwood, 89
- Camber of Culd, character description**
Heroes & Villains of the Deryni, 78
- Campaign design**
All Games Need Names, 75
Believe It or Not, Fantasy has Reality, 40
Books to Games? Perhaps!, 96
Boredom and the Average D&D Dungeon, 17
Cure for the "Same-Old-Monster" Blues, 21
D&D Option: Orgies, Inc., 10
Detailing a Fantasy World, 98
DRAGON Dungeon Design Kit, 45
Exploring Some Map Manuals, 72
From the City of Brass . . . to Dead Orc Pass, 37
Game Balance, 16
Hate Orcs? You'll Love This Campaign, 43
How to Have a Good Time Being Evil, 45
Let There Be a Method to Your Madness, 10
Making of a Milieu, 93
Mission Control, 48
Myth, Legend, and Folklore, 67
Non-violent Magic Items, 73
Plan before You Play, 63
Player Character and His Money, 74
Poison, 59
Role of Nature, 108
Sights and Sounds in DUNGEONS & DRAGONS, 17
Solo scenario, 73
Some Universal Rules, 53
Special Skills, Special Thrills, 85
Uncommon Tongue, 109
When the Rations Run Out, 107
Wizard with a Difference, 17
World of Difference, 105
- Characters**
Army Travels on Its Stomach, 94
CAU for NPC's Gives Encounters More Believability, 33
Cities Can Help Make Characters More "Real", 37
Creating a Cast of NPCs, 102
Gypsies, 59
In Defense of Extraordinary Characters, 24
Only Train When You Gain, 97
Plan It by the Numbers, 101
- What Good PCs Are Made Of, 96
see also Player characters; Non-player characters
- Deities**
Deities and Their Faithful, 97
How to Make a Pantheon You Can Have Faith in, 36
Of the Gods, 29
Presenting . . . the Monties, 37
To Select a Mythos, 25
see also Deities
- Encounters**
Encounters with Personality, 21
For Fearsome but Familiar Fiends, 34
Make Monsters, Not Monstrosities, 59
New Monsters for Low Levels, 66
Random Monsters, 10
Step-by-Step System for Urban Encounters, 37
Travel Works Both Ways, 105
Vampires in the Dungeon, 17
Wandering Monster, 15
Wart!, 65
Well-equipped Victim, 105
What is a Monster Worth?, 89
see also Monsters, general; Non-player characters
- Getting started**
Starting from Scratch, 39
- Ideas**
Instant Adventures, 48
- Setting**
Get out of the Medieval Rut, 81
Getting a World into Shape, 49
Inns and Taverns, 29
Libraries, 37
Map Hazard, Not Haphazard, 56
Weather in the World of Greyhawk, 68
- Setting, aquatic**
Aquatic Encounters with Megaflora, 32
Dastardly Deeds & Devious Devices, 41
Take the Plunge!, 48
Water, Water Everywhere, 41
What's That In The Water?, 68
- Setting, dungeon**
Gas 'em up and Smoke 'em out, 45
Hints for D&D Judges, Part 3: The Dungeons, 2
Tombs & Crypts, 9
- Setting, Ice Age**
Thrills and Chills, 68
- Setting, jungle**
Jungle Fever, 31
Vacation Spot? Certainly Not!, 31
- Setting, modern**
Modern Monsters, 57
- Setting, outdoors**
Battles above the Dungeon, 95
Beyond the Dungeon, Part 1,87
Beyond the Dungeon, Part 2,88
Designing for Unique Wilderness Encounters, 10
Hints for D&D Judges, Part 2: Wilderness, 1
Weather in the Wilderness, 15
- Setting, Planes of Existence**
Astral Plane, 67
Elementary Ideas for Elemental Adventuring, 47
Inner Planes, 42,73
Nine Hells, 75,76,91
Playing on the Other Planes of Existence, 32
Random Generation of Creatures from Lower Planes, 23
- Setting, ruins**
Ruins, 54
- Setting, science fiction**
Dwarves in Space, 70
- Setting, town**
City Campaigns, 37
Development of Towns in D&D, 8
Locals Aren't All Yokels, 109
Random Events Table for Settlements, 15
That's Life in the Big City, 99
- Social structure**
'Caste' of Real Characters, 70
Economics Made Easy, 107
How Taxes Take Their Toll, 95
Law of the Land, 65
Playing the Political Game, 90
- Treasure**, see **Treasure**
- Campaign design**, see also Leomund's Tiny Hut
- Can Seapoint be Saved?:** AD&D adventure for 4th-7th level characters, by Bob Waldbauer, 75
- Canaanite gods**
Near Eastern Mythos, 16
- Canard:** A TRAVELLER adventure, by Roberto Camino, 43
- Candle of Methven** by R. Forsten, 39
- Cantobele** by Ed Greenwood, 89
- Cantrips**
More Cantrips, 60
- Cantrips: Minor Magics for Would-Be Wizards** by Gary Gygax, 59
- Cantrips for Clerics:** O-level magic for deities to dish out, by Arthur Collins, 108
- Cantrips for the Aspiring Illusionist** by Gary Gygax, 61
- Careers in Star Law:** More on interstellar law enforcement, by Alex Curylo, 91
- Carnivorous flying squirrel**
New Monsters for Low Levels, 66
- Cash & Carry For Cowboys** by Glenn Rahman, 54
- Cast of Strange Familiars:** M-U's best friend comes in many shapes and sizes, by Stephen Inniss, 84
- 'Caste' of Real Characters** by Frank Mentzer, 70
- Casting Spells for Cash:** How magic-user PCs can earn their keep, by Fraser Sherman, 106
- Castles**
Fights of Fantasy, 79
Great Stoney, 86,97
Knock, Knock!, 52
Who Lives in That Castle?, 80
- Castles by Carroll** by Mike Carroll
I: Neuschwanstein, 68
II: Wawel Castle, 69
III: Jericho, 70
IV: The Tower of London, 72
V: Leeds Castle, 73
- Castles, Castles, Everywhere** by Michael Kluever, 45
- Catoblepas**
Ecology of the Catoblepas, 73
- Catstaff** by Ed Greenwood, 99
- CAU for NPCs Gives Encounters More Believability** by H. R. Lovins, 33
- Cavalier**
Chivalrous Cavalier, 72
- Cavalry Plain at Austerlitz** by Bill Fawcett, 28
- Cavemen**
Thrills and Chills, 68
- Cavern of the Sub-Train:** GAMMA WORLD scenario, by Gary Jaquet, 52
- Cavern Quest:** A competition module for AD&D play, by Bill Fawcett, 54
- Celestial, Greyhawk deity**, 68
- Celtic myths**
Tuatha De Danaan, 65
Druid in Fact and Fantasy, 32
- Censer of Thaumaturgy** by Ed Greenwood, 91
- Centaur**
Centaur Papers, 103
Rest of the Papers, 105
- Centaur Papers:** Two manuscripts become one very long article, by Stephen Inniss and Kelly Adams, 103
- Ceremony, cloistered cleric spell**, 68
- Chagmat:** An AD&D adventure for 1st-4th levels, by Larry DiTillio, 63
- Chain Lightning, magic-user spell**, 68
- CHAINMAIL Revisited:** Jousting in D&D, by Jon Pickens, 17
- Chakram**
Or With A . . . Weird One, 61
- Chamber of the Godgame** by Mick McAllister, 18
- Chamo, Duke of Hell**, 75
- CHAMPIONS**
Honorable Enemy, 108
Lions, Tigers, & Superheroes, 85
Patching the Cracks in CHAMPIONS, 73
Skills for the Super Agent, 90
- CHAMPIONS Plus!** New powers for CHAMPIONS heroes, by Steven Maurer, 100
- Chance of a Lifetime:** BATTLESYSTEM project was a designer's dream, by Doug Niles, 100
- Change of Diet:** A new mutational defect for GAMMA WORLD gaming, by Tom Adams, 109
- Changesafe, druid spell**, 71
- Chapel of Silence:** D&D adventure, by Mollie Plants, 50
- Character abilities**, see **Abilities**
- Character action, determining outcome**
How to Use Non-Prime-Requisite Character Attributes, 1
Short Hops and Big Drops, 93
You Can Jump How Far? OK, Prove It!, 45
- Character class**
Big, Bad Barbarian, 63
Character Classes to Consider, 65
Chivalrous Cavalier, 72
Customized Classes, 109
He's Got a Lot to Kick About, 53
Hooves and Green Hair, 109
Level Titles Don't Do Justice, 72
Loyal Readers: EGG answers questions, 67
"Split Class" for Nimble Characters: Thief-Acrobat, 69

- Wanted: Bounty Hunters, special section, 52
 What Good PCs Are Made Of, 96
- Character Classes to Consider** by Gary Gygax, 65
- Character conversion**
 Guidelines for Mixing Campaigns, 18
- Character that Really Counts**, by Dean Coldham, 48
- Charging Isn't Cheap**: How to make and fix rods, staves, and wands, by Peter Johnson, 101
- Chariots for Characters**: Adapting ancient vehicles for AD&D play, by Pete Mohney, 81
- Charisma**
 Make Charisma Count for More, 63
 New Loyalty Base, 107
 Six Main Skills, 107
- Charisma Counts!**: A new charisma system for the VILLAINS & VIGILANTES game, by S. D. Anderson, 100
- Charissa, character description**
 Heroes & Villains of the Deryni, 78
- Charm spell**
 Hold That Person!, 90
- Charts for Determining the Location of Treasure** by Ronald Guritzky, 19
- Chess**
 Game within a Game, 70
- Chi-square test of dice bias**
 Be Thy Die Ill-Wrought?, 78
 BASIC Program to Calculate Chi-square Values, 78
- Chimera**
 Ecology of the Chimera, 94
- Chinatown: The Jaded Temple**: TOP SECRET adventure, by Jerry Epperson, 62
- Chinese Dragons** by David Sweet, 24
- Chinese myths**
 Righteous Robbers of Liang Shan P'o, 54
- Chinese Undead** by David Sweet, 26
- Chivalrous Cavalier** by Gary Gygax, 72
- CHIVALRY & SORCERY**
 Monster Mixing, 49
- Choir Practice at the First Church of Lawful Evil (Orthodox)**: The ramifications of alignment, by Lawrence Schick, 24
- Chromatic Orb, illusionist spell**, 66
- Chronology of Minaria** in "Minarian Legends", by Glenn Rahman, 57
- Circe, character description**
 Island Enchanters, 52
- Citadel by the Sea**: AD&D adventure for low-level characters, by Sid Fisher, 78
- Cities Can Help Make Characters More "Real"** by Paul A. Leathers, 37
- City adventures**
 City Campaigns, special section, 37
 see also Campaign design: Setting
- City Beyond the Gate**: AD&D adventure for high-level characters, by Robert Schroeck, 100
- Civilizations: From High to Low** by T.J. Kask, 31
- CLASSIC WARFARE**
 Roman Military Organization, 24
- Cleric**
 Cleric Collection, 85
 Clerics, Take Note: "No Swords" means NO Swords!, 33
 Clerics Live by Other Rules, 92
 Clerics Must be Deity-Bound, 85
 Clerics Must Pay for Skills, 89
 First Spread the Faith, 92
 Here's to Your Health, 85
 Laws of Magic, 106
 More, the Merrier, 92
 Role of the Cleric, 52
 Sage Advice, 52
 Sense of Sacrifices, 52
 Special Skills, Special Thrills, 85
 Why Magic-Users and Clerics Cannot Use Swords, 16
 Working Your Way up to First Level, 51
- Healer subclass**
 Healers, 3
- spells**
 Beefing up the Cleric, 58
 Cantrips for Clerics, 108
 Cloistered Cleric, 68
 Curses, 29
 Curses!, 77
 in the Nine Hells, 76
- weapons**
 Should They Have An Edge? No, 66
 Should They Have An Edge? Yes, 66
- Cleric, dwarven**
 New Jobs for Demi-Humans, 96
- Cleric, wandering**
 This Land is My Land. . . , 52
- Cleric Collection**: Three ways to give the class more flash, 85
- Clerics, dragon**
 Dragons and Their Deities, 86
- Clerics, Take Note: "No Swords" means NO Swords!** by Lawrence Huss, 33
- Clerics Live by Other Rules** by Gary Gygax, 92
- Clerics Must be Deity-Bound**: How one acts depends on who one worships, by Fraser Sherman, 85
- Clerics Must Pay for Skills**, by Len Lakofka, 89
- Climate**
 Weather in the World of Greyhawk, 68
- Cloistered Cleric** by Len Lakofka, 68
- Cloud Castles** by Roger Moore, 39
- Cloudburst, druid spell**, 71
- Cloudburst, magic-user spell**, 67
- Coats of arms**
 Understanding Armory, 53
- Cockatrice**
 Ecology of the Cockatrice, 95
- Coinage systems**
 For the Sake of Change, 63
- Colfel** by Richard Lucas, 56
- Collection of Canines**: More dogs than you can throw a stick at, by Stephen Inniss, 102
- College Courses and Vital Statistics** in "Rasmussen Files" by Merle Rasmussen, 51
- Combat**
 Action in the Melee Round, 43
 Battles above the Dungeon, 95
 Be a Creative Game-Player, 45
 Combat Computer, 74
 New Charts, Using the "5% principle", 80
- Attack Priority System**
 Who Gets The First Swing?, 71
- Computer-conducted**
 Dungeon Master's Familiar, 80
- Hand-to-hand**
 Without Any Weapons, 61
- Monk**
 Monkish Combat in the Arena of Promotion, 2
- Combat, by giants**
 Giant-sized Weapons, 109
- Combat, unarmed**
 How to Finish Fights Faster, 83
- Combat, with psionics**
 Psionics is different, 78
- Combat Computer** designed by Laura and Tracy Hickman, 74
- Combat Modifications for Dexterity**, table, by Steve Cline, 3
- Combine, cleric spell**, 58
- Comeliness**
 Loyal Readers: EGG answers questions, 67
- Coming of the S'sessu**: A new alien race for the STAR FRONTIERS game, by David Cook, 96
- Common Tongue**, see Language
- Communicate, cloistered cleric spell**, 68
- Compendium of Diverse D&D Player Personalities**, or, A pigeonhole for nearly everyone you ever adventured with, by Mike Crane, 19
- Compsognathus**
 New Monsters for Low Levels, 66
- Computer**
 D&D Meets the Electronic Age, 26
 DM's Right-Hand Man, 36
 Dungeon Master's Familiar, 80
 Role of Computers, 110
- Computer Games Have a Way to Go** by Michael Brian Bentley, 63
- Computer program**
 What do You Get When You Cross a DM with a Computer?, 74
- Conan!** by Gary Gygax, 36
- Conquistadores**
 Arms and Armor of the Conquistadores, 25
- Constitution**
 Six Main Skills, 107
- Contingency, magic-user spell**, 68
- Conversion reaction table**
 More, the Merrier, 92
- Cooshee** by Gary Gygax, 67
- Corkie** by Roger Moore, 89
- Coyote**
 Collection of Canines, 102
- Cozbi, Princess of Hell**, 75
- Crane is What You Make It** by Richard A. Lloyd, 46
- Crawling Claw** by Ed Greenwood, 32
- Creating a Cast of NPCs**: To do it nice, do more than roll the dice, by Jim Dutton, 102
- Creating Tailor-Made Monsters** by Len Lakofka, 108
- Creative Conjuring**: A variant magic system for the MARVEL SUPER HEROES game, by Eric Walker, 100
- Creative Magic Items**: DMs are not limited to what's in the book, by Ken Hughes, 98
- Creature Catalog**: A menagerie of new monsters for you, 89
- Creature Catalog II**, 94
- Creature Catalog III**, 101
- Creature of Rhyll**: D&D adventure, by Kevin Knuth, 55
- Creatures from Elsewhere** by Patrick Amory, 47
- Credit Where Credit is Due**: Elaborating upon the experience-point rules, by Katharine Kerr, 95
- Creeping Pit** by Dan Proulx, 101
- Crimefighters**: A pulp-fiction role-playing game, by David Cook, 47
- Critical hit effects table**
 Good Hits and Bad Misses, 39
- Crusading Life** by Bruce Humphrey, 107
- Cryoserpent** by Roger Moore, 44
- Crystalbrittle, magic-user spell**, 68
- Cu Chulainn, character description**, by Roger Moore, 81
- Cult of the Dragon**: The dreaded dracolich and the sorcerers who create them, by Ed Greenwood, 110
- Cure for the "Same-Old-Monster" Blues** by William Callison, 21
- Cure spells**
 Here's to Your Health, 85
- Curing the Monty Haul Malady** by Roger Moore, 82
- Curses**: Never get even - get ahead! by Harold Pitt, 29
- Curses!**: Twenty good ideas for bad tidings, by Ed Greenwood, 77
- Curst** by Ed Greenwood, 30
- Customized Classes**: How to put together one-of-a-kind characters, by Paul Montgomery Clabaugh, 109
- Cutter, character description**
 Elfquest, 66
- Cyrollalee**
 Gods of the Halfings, 59
- D&D**
 And Then There Were Three, 84
 DUNGEONS & DRAGONS: What It is and Where It is, 22
 Gary Gygax on DUNGEONS & DRAGONS, 7
 Reflections of a Real-Life Cleric, 41
 Short Course in D&D, 28
 Three Challenges in One, 104
 Uniformity, Conformity. . . or neither?, 39
 War Machine Revisited, 109
- Conversion to science fiction**
 Guidelines for Mixing Campaigns, 18
- D&D adventure**
 Chapel of Silence, 50
 Creature of Rhyll, 55
 Faceless Men & Clockwork Monsters, 17
 Fell Pass, 32
 Hail of Mystery, 21
 Halls of Beoll-Dur, 41
 Sword of Justice, 92
- D&D Ground and Spell Area Scale** by Gary Gygax, 15
- D&D Meets the Electronic Age** by Rick Krebs, 26
- D&D Option: Demon Generation** by Jon Pickens, 13
- D&D Option: Determination of Psychic Abilities** by David W. Miller, 6
- D&D Option: Orgies, Inc.:** Too Much Loot in Your Campaign?, by Jon Pickens, 10
- D&D Option: Weapon Damage** by Jon Pickens, 2
- D&D Relationships, the Parts and the Whole** by Gary Gygax, 14
- D-DAY, A More Accurate Variation** by Robert Barrow, 34
- Dagger +1/+2 vs. Dolphins** by Roger Moore, 91
- Dagger of Alignment Detection** by Robert Tussey, 91
- Dagger of Monster Calling**
 Nasty Additions to a DM's Arsenal, 77
- Dagon, greater devil**, 91
- Dakarnork, Kobold Demigod**
 . . . But not least: The Humanoids, 63
- Damage, falling**, see Falling damage
- Damage Permanency** or, How Hrothgar One-Ear Got His Name, by James M. Ward, 23
- Damage to weapons, tables**
 These are the Breaks, 54
 When It Gets Hit, It Gets Hurt, 73
- Dancing Hut**: AD&D adventure for high-level characters, by Roger Moore, 83
- Danger on a Budget**: The unexpected and the unknown in GAMMA WORLD adventuring, by B. Humphrey, 99
- Danger**: This Document is Loaded by Merle Rasmussen, 49
- Dao** by Gary Gygax, 66
- Dark Dwellers** by Mark Cummings, 51
- Dastardly Deeds & Devious Devices**, 34,35,41
- DAWN PATROL**
 Up, Up and Away, 68
- Death Angel** by John Sullivan, 6

- Death Fog, illusionist spell, 66**
- Death master**
For NPCs Only: The Death Master, 76
- Death Prayer, cleric spell, 58**
- Deck of Fate** by Kevin Hendryx, 26
- Deck of many things**
Tarot of Many Things, 77
- Deeppockets, magic-user spell, 67**
- Defenders Ensemble!** in "The MARVEL-Phile", by Jeff Grubb, 100
- Defenders of the Future:** MARVEL's Guardians of the Galaxy, by William Tracy, 100
- Defining and Realigning the Monk** by Steven D. Howard, 53
- Deionychus, 55**
- Deities and demigods**
Choir Practice at the First Church of Lawful Evil, 24
Clerics Must be Deity-Bound, 85
Down-to-Earth Divinity, 54
Elemental Gods, 77
Feathered Serpent, 2
First Spread the Faith, 92
For Better or Worse: I, 110
For Better or Worse: II, 110
Gods of the Elves, 60
Gods of the Gnomes, 61
Gods of the Halflings, 59
Gods of the Orcs, 62
Gods of the Suel Pantheon, 86,87,88,89,90,92
Japanese Mythos, 13
Messengers of God, 17
More, the Merrier, 92
Mythos of Africa in DUNGEONS & DRAGONS, 27
Mythos of Australia in DUNGEONS & DRAGONS, 19
Mythos of Oceania in DUNGEONS & DRAGONS, 29
Mythos of Polynesia in DUNGEONS & DRAGONS, 20
Near Eastern Mythos, 16
Of the Gods, 29
Origins of the Norse Pantheon, 29
Persian Mythos, 12
Plane Facts on Gladsheim, 90
Politics of Hell, 28
Righteous Robbers of Liang Shan P'o, 54
Role of the Cleric, 52
Special Skills, Special Thrills, 85
Standard Divine Abilities, table, 68
Tuatha De Danaan, 65
- Demi-deity**
Setting Sainly Standards, 79
see also Campaign design: Deities
- Deities and Demigods of the World of Greyhawk** by Gary Gygax
Heironeous, Hextor, Iuz, St. Cuthbert, 67
Celestian, Fharlanghn, Ehlonna, Pholtus, Triitheon, 68
Istus, Time Elemental, Obad-hai, 69
Boccob, Zagyg, Olidammara, 70
Erythnul, Incabulos, Nerull, Ralishaz, Wastri, 71
- Deities and Their Faithful:** How gods and worshipers fit into the AD&D game, by Gary Gygax, 97
- Delude, illusionist spell, 66**
- Demand, magic-user spell, 68**
- Demi-humans**
All about Gully Dwarves, 102
All about the Kender, 101
Elves, Dwarves & Halflings: for Appearance's Sake, 41
Gnomish Point of View, 61
Halfling Point of View, 59
Ja-Ga-Oh: Little People of the Iroquois, 61
New Jobs for Demi-Humans, 96
Race is Ahead of Class, 104
Sage Advice, 66
Smaller Than Man-Sized Weapons Table, 29
Tone Down the Demi-humans, 105
Winged Folk, 51
- Demi-humans, birthplaces**
Adding Depth to the Flanaess, 52
- Demi-humans, mercenaries, fable**
Fighters for a Price, 109
- Demi-humans Get a Lift** by Gary Gygax, 95
- Demonbane** by Ed Greenwood, 91
- Demonic Possession in the Dungeon** by Charles Sagui, 20
- Demonology Made Easy** or, How to deal with Orcus for fun and profit, by Gregory Rihn, 20
- Demons**
D&D Option: Demon Generation, 13
Demonic Possession in the Dungeon, 20
Demonology Made Easy, 20
Goristro Revealed, 91
Nine Hells, Part I, 75
Patron Demons, 42
- Demons, Devils and Spirits** by Tom Moldvay, 42
- Deryni**, adapted by Arthur Collins, 78
- Designer Responds to First Volley:** interview with Bill Fawcett, 26
- Designing for Unique Wilderness Encounters** by Daniel Clifton, 10
- Detailing a Fantasy World:** After mapping comes mixing and fixing, by Jim Dutton, 98
- Detect Curse, cloistered cleric spell, 68**
- Detect Illusion, magic-user spell, 67**
- Detect Life, cleric spell, 58**
- Detect Poison, druid spell, 71**
- Deva** by Gary Gygax, 63
Poker, Chess and the AD&D System, 67
- Development of Towns in D&D** by Tony Watson, 8
- Developments from Stonefist to South Province** by Gary Gygax, 57
- Devil Spider** by Erol Otus, 55
- Devils**
Demons, Devils and Spirits, 42
Eight Devilish Questions, 91
New Denizens of Devildom, 75
Nine Hells, 75, 76
Nine Hells Revisited, 91
Politics of Hell, 28
Possessors, 42
- Dexterity**
Six Main Skills, 107
Combat Modifications for Dexterity, table, 3
- Dhole**
Collection of Canines, 102
- Diarmuid's Last Jest:** "He who laughs last. . ." by Arthur W. Collins, 60
- Dice**
Be Thy Die Ill-Wrought?, 78
BASIC Program to Calculate Chi-square Values, 78
Same Dice, Different Odds, 94
- Different Design:** Tips for making tournament adventures, by Lisa R. Cohen, 108
- Dimensional travel**
Sorry, Wrong Dimension!, 101
- Dingo**
Collection of Canines, 102
- Dinosaurs:** New theories for old monsters, by Lawrence Schick, 55
- Diplodocus, 55**
- Dis, plane of the Nine Hells, 75**
- Disbelieving**
Familiarity Prevents Illusionists from Stealing Show, 66
Now You See It. . . But is It Really There?, 43
- Discus Shield** by Roger Moore, 37
- Disease**, table by Lenny Buetner, 24
see also Lycanthropy
- Dismiss undead, cloistered cleric spell, 68**
- Dismissal, magic-user spell, 68**
- Dispel Illusion, magic-user spell, 67**
- Dispel Magic, illusionist spell, 66**
- Displacer Beast**
Ecology of the Displacer Beast, 109
- Divine abilities**
Presenting the Suel Pantheon, 86
Standard Divine Abilities, 68
- Divine intervention**
Of the Gods, 29
- DIVINE RIGHT**
Barbarian North and the Youth of Juulute Wolfheart, 39
Bilge Rat and the Mercenary Fleets of Minaria, 48
Black Hand, 46
Black Knight, 44
Chronology of Minaria, 57
Eaters of Wisdom, 49
Evolution of the Shucassamites, 52
History of Dwarves, 45
History of Elfland, 37
History of Hothior, 35
History of Immer, 36
History of Mivior, 38
History of Muetar, 34
History of Pon, 42
History of Rombune, 54
History of Zorn and the Goblins, 50
Making a Great Game Greater, 34
Minarian Variants, 46
Monsters of Minaria, 56
Monuments of Minaria, 55
Schardenzar's Story, 51
Trolls, 41
- DIVINE RIGHT Design Note** by Glenn and Kenneth Rahman, 27
- DM**, see Dungeon Master
- DM's Right-Hand Man** by Roy Earle, 56
- Doctor Yes:** The floating island mission, by Merle Rasmussen and James Thompson, 48
- Does Anyone Here Speak Aslan?:** Language skills in TRAVELLER gaming, by Joseph Benedetto, Jr., 91
- Dog**
Collection of Canines, 102
Dozen Domestic Dogs, 103
- Dokyu**
Or With A . . . Weird One, 61
- Dolor, magic-user spell, 68**
- Dolphins of Known Space:** A new race for the RINGWORLD game, by Sherman Kahn, 95
- Don't Drink This Cocktail - Throw It!** by Robert Plamondon, 40
- Don't Just Think about It . . . Take the AD&D Exam** by Philip Meyers, 47
- Don't Leave Home Without 'Em!** New Equipment for GAMMA WORLD gaming, by Scott Hutcheon, 91
- Don't Look! It's a . . .** by Lewis Pulsipher, 50
- Doomkeep, AD&D Masters tournament, 34**
- Door**
"Just" a Door? Not Any More!, 53
More than a Door, 41
Open Them, If You Dare, 106
- Doppleganger**
Psychology of the Doppleganger, 80
- Double-Helix Connection:** Mutants in TRAVELLER gaming, by Michael Brown, 109
- Down-to-Earth Divinity:** One DM's design for a mixed & matched mythos, by Ed Greenwood, 54
- Dozen Domestic Dogs:** Twelve ways to classify man's best friend, by Stephen Inniss, 103
- Dracolich**
Cult of the Dragon, 110
- Dracones** by K.L. Campbell, 101
- Dragon armor**
Evil Dragon Armors 62
- Dragon Damage Revised:** Claw and bite attacks graded by size and age, by Leonard Carpenter, 98
- Dragon Damage Revisited:** Finishing the figures for physical attacks, by Leonard Carpenter, 110
- DRAGON Dungeon Design Kit, 45**
- Dragon Magic** by Michael Benveniste, 15
- Dragon's Bestiary**, 26,27,29,30,31,32,33,34,36,37,38, 39,40,41,42,43,44,45,46,48,49,50,51,53,54, 55,56,58,59,61
- Dragon's Blood:** One Interpretation . . . and another, by Robert Plamondon and Tom Moldvay, 41
- Dragon's Eye** by Roger Moore, 91
- DRAGONCHESS** by Gary Gygax, 100
additional notes, 102
- Dragonhelm**, by R. Raupp & R. Moore, 86
- DRAGONLANCE**
All about Gully Dwarves, 102
All about Kryn'n's Gnomes, 103
All about the Kender, 101
Dragons of Kryn'n, 98
More Dragons of Glory, 107
My Honor Is My Life, 94
- DRAGONQUEST**
Enhancing the Enchanter, 82
For a Fuller Background, 97
Getting in over Your Head, 96
Going up and Getting Wet, 92
Learn Magic by the Month, 89
Thrill of the Hunt, 78
Travel and Threats for DRAGONQUEST, 49
Versatile Magician, 57
Warrior Alternative, 86
- Dragons**
Chinese Dragons, 24
Cult of the Dragon, 110
Dragon Damage Revised, 98
Dragon Damage Revisited, 110
Dragon Magic, 15
Dragons and Their Deities, 86
Dragons of Kryn'n, 98
Faerie Dragon, 62
Grey Dragon, 62
Hatching is Only the Beginning, 50
Landragons, 74
Magic of Dragon Teeth, 98
Missing Dragons, 65
Rearranging and Redefining the Mighty Dragon; 38
Self Defense for Dragons, 50
Steel Dragon, 62
Tailor-Made Treasure, 98
True Dragons, 50
- Dragons, neutral**
That's Not in the Monster Manual!, 37

Dragons and Their Deities: The lowdown on how and why they worship, by Alan Zumwalt, 86

Dragons of Krynn: More background for DRAGONLANCE campaigns, by Roger Moore, 98

Dream, illusionist spell, 66

Druid

- Cantrips for Clerics, 108
- Character Classes to Consider, 65
- Druid in Fact and Fantasy, 32
- Druid and the DM, 48
- Druid in a Dungeon? Why Not?, 48
- Druids, 12
- Life beyond the 15th Level, 93
- New Druid Spells . . . Naturally, 71
- This Land is My Land. . . , 52

Druid and the DM by Tim Lasko, 48

Druid in a Dungeon? Why Not? by Tim Lasko, 48

Druid in Fact and Fantasy by William Fawcett, 32

Druid/Ranger

- All about the Druid/Ranger, 100

Druids by James Bruner, 12

Dryad

- Hooves and Green Hair, 109
- Ecology of the Dryad, 87

Duchy of Tenh

- Protection Circles and the Like, 56

Dueling Dragons by Robert Camino, 41

Dueling Room by Jeff Swycaffer, 40

Duelist: A chaotic NPC who likes to make people pay, by Arthur Collins, 73

Duh 'cology of . . . Duh Ettin! by Ed Greenwood, 92

Duh Jock by Jon Mattson, 72

Duleep by Ed Greenwood, 89

Dungeon design kit

- Dragon Dungeon Design Kit, 45

Dungeon Master

- Dungeon Master Evaluation Form, 43
- Dungeon Master's Familiar, 80
- Level Progression for Players and Dungeon Masters, 28
- Notes from a Very Successful D&D Moderator, 26

Dungeon Master, advice to

- Assessing, Not Guessing, 104
- Beyond the Rule Book, 75
- Blades With Personality, 109
- Blueprint for a Big Game, 97
- Boredom and the Average D&D Dungeon, 17
- Clerics Live by Other Rules, 92
- Credit Where Credit is Due, 95
- Curing the Monty Haul Malady, 82
- Druid and the DM, 48
- Experience Points to Ponder, 36
- Five Keys to DMing Success, 80
- History of a Game That Failed, 99
- How Do You Rate as a DM?, 43
- In Defense (Once Again) of the "Poor" Magic-User, 34
- Keeping the Magic-User in His Place, 24
- Law of the Land, 65
- Mission Control, 48
- New Spells in D&D, 18
- Only Good Captive . . . , 97
- Only Train When You Gain, 97
- Overhauling the System, 78
- Painted Ladies & Potted Monks, 36
- Plan Before You Play, 63
- Plan It by the Numbers, 101
- Plants of Bimirion, 108
- Playing the Political Game, 90
- Putting Together a Party on the Spur of the Moment, 26
- Rewarding Heroism in D&D, 29
- Role of Nature, 108
- Short Course in D&D, 28
- Sights and Sounds in DUNGEONS & DRAGONS, 17
- Specialization and Game Balance, 104
- Varied Player Character & Non-Player Character Alignment, 9
- Was It Worth the Risk?, 104
- Ways to Handle High-level Headaches, 45
- What Good PCs Are Made Of, 96
- You've Always Got a Chance, 68

Dungeon Master, choosing

- When Choosing a DM, Be Choosy!, 48

Dungeon Master, development of

- Way We Really Play, 106

Dungeon Master Evaluation Form, 43

Dungeon Master's Familiar: A program for computer-conducted combat, by John Warren, 80

Dungeon Masters Guide: Developers' notes, by Jake Jaquet, et al., 28

- And a Few Words from the Author, 28
- Official Errata, 35

Dungeon setting

- Dungeons and Prisons, 23
- Hints for D&D Judges, Part 3: The Dungeons, 2
- see also Campaign design: Setting

DUNGEON! - More Variations on the Theme by George Laking, 24

- Hobbits and Thieves in DUNGEON!, 1
- Monk and Bard in DUNGEON!, 17
- That "Other" Dungeon, 21

DUNGEONS & DRAGONS: What It Is and Where It Is Going by Gary Gygax, 22

DUNGEONS & DRAGONS game, see D&D

Dungeons and Prisons or, A 'No-Tears' formula for getting rid of high-level characters, by Mark S. Day, 23

Dungeons Aren't Supposed to be "For Men Only" in "Up on a Soapbox", by Roger Moore, 57

Duskur, greater devil, 91

Dust Devil by Bruce Sears, 45

Dust Devil, cleric spell, 58

Dust of Forgetfulness by Richard Webb, 99

Dwarf

- Elves, Dwarves & Halflings: for Appearance's Sake, 41
- Hate Orcs? You'll Love This Campaign, 43
- New View of Dwarves, 3
- Quick Look at Dwarves, 27
- Worth Its Weight in Gold, 109

Dwarf, as locksmith

- Race is Ahead of Class, 104

Dwarf, bearded female

- Good isn't Stupid, Paladins & Rangers, etc., 38

Dwarf, gully

- All about Gully Dwarves, 102

Dwarf, language

- Old Dwarvish is Still New to Scholars of Language, 66

Dwarven lord, followers of

- Tables and Tables of Troops, 99

Dwarves in Space by Roger Moore, 70

Dyil by Ed Greenwood, 55

Earth, god

- Elemental Gods, 77

Eaters of Wisdom in "Minarian Legends", by G. Rahman, 49

Ecology articles

- Basilisk by Ed Greenwood, 81
- Beholder by Ed Greenwood and Roger Moore, 76
- Bulette by Chris Elliott and Richard Edwards, 74
- Catoblepas by Chris Elliott and Richard Edwards, 73
- Chimera by Ed Greenwood, 94
- Cockatrice by Ed Greenwood, 95
- Displacer Beast by Bill Mickelson, 109
- Dryad by Shaun Wilson, 87
- Eye of the Deep by Ed Greenwood, 93
- Gorgon by Ed Greenwood, 97
- Gulguthra (Otyugh, Neo-otyugh) by Ed Greenwood, 96
- Ixitxachtli by Ed Greenwood, 85
- Leucrotta by Ed Greenwood, 91
- Maeder (Medusa) by Ed Greenwood, 106
- Mimic by Ed Greenwood, 75
- Mind Flayer by Roger Moore, 78
- Ochre Jelly by Ed Greenwood, 104
- Pernicon by John Nephew, 108
- Peryton by Nigel Findley, 82
- Piercer by Chris Elliott and Richard Edwards, 72
- Rust Monster by Ed Greenwood, 88
- Sea Lion by Ed Greenwood, 107
- Slithering Tracker by Ed Greenwood, 86
- Stirge by Ed Greenwood, 83
- Trapper by Ed Greenwood, 84
- Treat by Susan Lawson, 79
- Unicorn by Roger Moore, 77
- Will-o-Wisp by Nigel Findley, 99

Economic Class, Of character

- Social Status and Birth Tables, 70

Economics Made Easy: How to use the basic principles in your campaign, by Ralph Marshall, 107

Effective Use of Poison by Bill Coburn, 18

Egder, Norse figure, 110

Egil Skallagrímon, character description, by Tom Moldvay, 39

Ehlonna, Greyhawk deity, 68

Eidolon of Khalk'Ru by Ernest N. Rowland, Jr., 45

Eight Devilish Questions . . . with answers that Titivilus wouldn't give, by Ed Greenwood, 91

Ektrat by Gregg Sharp, 94

Electrum Dragon by Ed Greenwood, 74

Elefant Hunt, board game by Tom Wham, 88

Elemental, Time

- Deities and Demigods of the World of Greyhawk, 69

Elemental Gods: A four-part approach to campaign deities, by Nonie Quinlan, 77

Elemental planes

- Elementary Ideas for Elemental Adventuring, 47
- Inner Planes: A new way to look at the AD&D world, 73

Elementals and the Philosopher's Stone by Jeff Swycaffer, 27

Elementary Ideas for Elemental Adventuring by Steven Kienle, 47

Elf

- Elven Point of View, 60
- Elves, Dwarves & Halflings: for Appearance's Sake, 41
- Gods of the Elves, 60
- Half-Elven Point of View, 60
- Sage Advice, 60
- Valley Elf, 67

Elfquest: Fantasy comic characters fleshed out for AD&D play, by Karl Merris, 66

Elminster

- All about Elminster, 110
- Bats That Do More Than Bite, 90
- More Pages from the Mages, 69
- Nine Wands of Wonder, 102
- Open Them, If You Dare, 106
- Pages from the Mages, 62
- Pages from the Mages III, 92
- Pages from the Mages IV, 97
- Pages from the Mages V, 100
- Runestones, 69
- Seven Swords, 74
- Six Very Special Shields, 89

Elven Point of View by Roger Moore, 60

Elves, Dwarves & Halflings: for Appearance's Sake by H. R. Lovins, 41

Elvish Tactics in Fantasy Miniatures by Lance Harrop, 28

EMERALD TABLET Design Notes by Jay Facciolo, 27

EMPIRE OF THE PETAL THRONE

- Battle of the Temple of Chanis: 2020 A.G., 4
- Birth Tables and Social Status, 26
- Legions of the Petal Throne Painting Guide, 6
- Military Formations of the Nations of the Universe, 7
- New Profession for EPT: The Adventurer, 31
- Naming People, Places, and Things in Petal Throne, 24
- Percentile Roll to Obtain an "Eye", 4
- Reports Submitted to the Petal Throne, 4
- Seal of the Imperium, 9, 11

EN GARDE in Solitaire by George Laking, 23

Enchanting Incantatrix: A spell-shielding, spell-stealing NPC class, by Ed Greenwood, 90

Encounters with Personality or, How to amuse the Dungeon Master! by Rod Stevens, 21

Encumbrance

- Let a Mule Do It for You, 48
- It Weighs What?, 23

Endure Cold, cleric spell, 58

Energy Drain, magic-user spell, 68

Enhancing the Enchanter: Changes and additions to DRAGONQUEST rules, by Craig Barrett, 82

Ensnarement, magic-user spell, 68

Enthral, cleric spell, 58

Environment, effects of

- Role of Nature, 108

Equipment

- Army Travels on Its Stomach, 94
- How Many Coins in a Coffe?, 80
- It Weighs What?, 23
- Knowing What's in Store, 98
- Let a Mule do It for You, 48
- Prices for the Roaring 20's, 95
- When It Gets Hit, It Gets Hurt, 73

Erevan Ilesere, god of mischief

- Gods of the Elves, 60

Erythnul, Greyhawk deity, 71

Escape

- Many Ways of Getting Away, 55

Ethereal Plane

- Astral Plane, 67
- Inner Planes, 42
- Planes, 8

Ettin

- Duh 'cology of . . . Duh Ettin!, 92

Euparkeria

- New Monsters for Low Levels, 66

Evard's Black Tentacles, magic-user spell, 67

Even Orcish is Logical: Make the system fit the speakers, by Clyde Heaton, 75

Everything You Never Knew about Spell Books by Gary Gygax, 62

Evil: Law vs. Chaos by Gary Gygax, 28

Evil characters

- Anti-Paladin NPC, 39
- see also Alignment

- Evil Dragon Armors** by Roger Moore, 62
- Evolution of the Shucassamites** in "Minarian Legends", by Glenn Rahman, 52
- Exonidas Spaceport:** A TRAVELLER adventure, by Jeff Swycaffer, 59
- Expanding the Frontier:** Exploring new worlds in the STAR FRONTIERS universe, by William Tracy, 105
- Expanding the Genre of RPGs:** GANGBUSTERS game recreates the Roaring 20's, 76
- Experience: by doing and learning** by Len Lakofka, 35
- Experience levels**
Gaining a New Experience Level, 10
Only Train When You Gain, 97
- Experience point values of monsters**
New Charts, using the "5% principle", 80
- Experience points**
Credit Where Credit is Due, 95
Mission Control, 48
Notes on Women & Magic, 3
Rewarding Heroism in D&D, 29
Thief's Climb Should be Leveled Out, 73
What is a Monster Worth?, 89
- Experience Points to Ponder:** A new system, by William Fawcett, 36
- Explodestool** by Alan Zumwalt, 89
- Exploring Some Map Manuals** in "Role of Books", by Lewis Pulsipher, 72
- Exterminator:** A special GAMMA WORLD encounter, by John Mau and Brian Shuler, 104
- Extraneous Magic Table**
Orlow's Inventions Can Live up Your Life, 30
- Eye contact**
Don't Look! It's a . . . , 50
- Eye of the Deep**
Ecology of the Eye of the Deep, 93
- Eyebite, magic-user spell, 68**
- Fabricate, magic-user spell, 68**
- Faceless Men & Clockwork Monsters:** A DUNGEONS & DRAGONS adventure aboard the Starship Warden, by Gary Gygax, 17
- Fachan** by Roger Moore, 89
- Faerie Dragon:** A chaotic, colorful new dragon-type, by Brian Jaeger, 62
- Fafhrd, character description,** by Lawrence Schick and Tom Moldvay, 27
- Falling damage**
in "From the Sorcerer's Scroll" by Frank Mentzer, 70
Kinetic Energy is the Key, 88
Physics and Falling Damage, 88
- Familiar**
Cast of Strange Familiars, 84
Familiars With a Special Use, 86
Table correction, 85
- Familiarity Prevents Illusionists from Stealing Show** by Gregory Quinn and Dale Young, 66
- Familiars with a Special Use:** New "pets" that match the magic-users who call them, by Stephen Inniss, 86
- Familiars, table correction, 85**
- Fantasy Genetics,** special section, 44
- Fantasy Miniature Rules** by Len Lakofka, 1
- Fantasy Philology:** Playing the fluency percentages, by Arthur Collins, 66
- Fantasysmith's Notebook,** 28,38,40
How Tall is a Giant?, 31
Miniature Spotlight, 34
Mystery of the Bow, 35
Ounce of Preparation is Worth a Ton of Paint, 29
Paradise for Painterly People, 33
Pity the Poor Hobgoblin, 32
Skeleton Crew: Down to the Bare Bones, 36
Work in Process: The Systematic Way, 39
- Fantra**
Plethora of Paladins, 106
- Fascinate, illusionist spell, 66**
- Fast and Deadly:** New starships for the STAR FRONTIERS Knight Hawks game, by Carl Smith, B6
- Fastest Guns that Never Lived, Parts I-IV,** by Allen Hammack, Brian Blume, G. Gygax, T. Kask, 36
- Fastest Guns that Never Lived, Part II** by Brian Blume, 9
- Fastest Guns that Never Lived, Part III** by A. Hammack, 19
- Fear and Fall Prison** by Ken Hughes, 41
- Feathered Serpent** by Lynn Harpold, 2
- Featured Creature,** 5,6,7,8
- Featured Creatures:** Official AD&D monsters for your campaign, by Gary Gygax, 63,64,65,67,68
- Federation Guide to Luna:** The moon in STAR TREK: The Role-Playing Game, by Dale L. Kemper, 85
- Fedifensor:** AD&D adventure for 7th and up, by Allen Rogers, 67
- Feel Like RISKing Everything?:** Adding thermonuclear tension to a classic game, by George Laking, 34
- Fell Pass:** a D&D adventure, by Karl Merris, 32
- Fearlanghn, Greyhawk deity, 68**
- Field Guide to Lunar Mutants:** The macrobes and plants of Tycho Center, by James M. Ward, 97
- Fighter**
Be a Two-Fisted Fighter, 68
Big, Bad Barbarian, 63
Mightier Than the Pen, 46
Working Your Way up to First Level, 51
- Berserker subclass**
New D&D Character Subclass: The Berserker, 3
- Cavalier subclass**
Chivalrous Cavalier, 72
- Followers, tables**
Tables and Tables of Troops, 99
- Level progression**
New Charts, using the "5% principle", 80
- Samurai subclass**
Samurai, 3
- Fighters for a Price:** Why to use mercenaries and how to find 'em, by James A. Yates, 109
- Fighting the Good Fight:** Combat variations in the SPACE OPERA game, by Stefan Jones, 109
- Fights of Fantasy:** Good generalship from a non-medieval viewpoint, by Lew Pulsipher, 79
- File 13:** Time, Money, and the Goon Show, by Tom Wham, 73
True Story of File 13, 72
- Filling in Skills:** Experience, service-switching make TRAVELLER more ability-oriented, by Jon Mattson, 55
- Fire, god**
Elemental Gods, 77
- Fire-eye Lizard** by Josh Susser, 40
- Firearms**
Second Volley, 70
Firearms, 60
- Fireball Fly** by Len Lakofka, 94
- Firestar** by Ed Greenwood, 94
- Firetail** by Ed Greenwood, 61
- Firewater, magic-user spell, 67**
- First Assassins** by James E. Bruner, 22
- First Spread the Faith:** Clerics need to keep their mission in mind, by Paul Vernon, 92
- Five Keys to DMing Success:** Make it easy on yourself and fun for your players, by Mike Beeman, 80
- Five New Enchanted Objects:** Magic items you won't find in the AD&D books, 86
- Flailtail** by Ed Greenwood, 89
- Flame Blade, druid spell, 71**
- Flamewing** by Ed Greenwood, 94
- Flaming oil**
Don't Drink This Cocktail — Throw It!, 40
- Flaming Sphere, magic-user spell, 67**
- Flandal Steelskin**
Gods of the Gnomes, 61
- Flard**
Creatures from Elsewhere, 47
- Flight of the Boodles:** Boardgame for two humans, by Chuck Stoll, 60
- Flitte** by Pat Rankin, 40
- Flo-lite** by Kevin Readman, 38
- Flowers and herbs**
Plants of Buirndon, 108
- Flute of Dismissing** by Richard Lucas, 47
- Flying mounts**
Ups and Downs of Riding High, 50
- Focalor, Duke of Hell, 75**
- Followers**
More Range for Rangers, 106
Tables and Tables of Troops, 99
- Food**
When the Rations Run Out, 107
- Food Fight,** board game, 44
- For a Fuller Background:** Heritage in the DRAGONQUEST game, 97
- For Better or Worse: I:** Equal time for the members of the Vanir, by Joel McGraw, 110
- For Better or Worse: II:** New descriptions of some old favorites, by Carl Sargent, 110
- For Fearsome but Familiar Fiends:** What every monster-maker needs, by Blake Ward, 34
- For King and Country:** An alignment system based on cause and effect, by Paul Suttie, 101
- For NPCs Only: The Death Master** by Len Lakofka, 76
- For Sail: One New NPC:** Welcome the mariner aboard in your game, by Scott Bennie, 107
- For the Sake of Change:** Coins through the ages, by David Nalle, 63
- Forceage, magic-user spell, 68**
- Forchoreai** by Peter Zelinski, 101
- Forest of Doom:** AD&D adventure for 4th-7th level, by Scott Butler, 73
- Foretelling**
Prophet Proofing, or, How to Counter Foretelling, 21
Deck of Fate, 26
- Forgery**
Handy Art of Forgery, 96
- Forgotten Realms**
All about Elminster, 110
Cult of the Dragon, 110
Down-to-Earth Divinity, 54
Into the Forgotten Realms, 95
Nine Wands of Wonder, 102
- Fortubo, Suel god, 88**
- Fortune telling**
Gypsies, 59
- Fox**
Collection of Canines, 102
- "Freeze! Star Law!":** The interstellar police of the STAR FRONTIERS game, by Kim Eastland, 87
- Frey, Norse god, 110**
- Freya, Norse goddess, 110**
- From Anarchy to Empire:** Interstellar governments in the STAR FRONTIERS game, by David Cook, 94
- From Spy World to Sprechenthalestelle** in "The Rasmussen Files", by Merle Rasmussen, 40
- From the Chronicles of Emaj the Rotund** "On the Derivation of Snit Sub-species", by James Ward, 11
- From the City of Brass . . . to Dead Orc Pass:** The theory and use of gates, by Ed Greenwood, 37
- From the Sorcerer's Scroll,** 11,23,35
AD&D's Magic System: How and Why It Works, 33
Advanced Illusion and Philosopher's Stone, 59
Books are Books, and Games are Games, 31
Cantrips: Minor Magics for Would-Be Wizards, 59
'Castle' of Real Characters, 70
Character Classes to Consider, 65
Clerics Live by Other Rules, 92
Conant, 36
D&D Ground and Spell Area Scale, 15
D&D Relationships, the Parts and the Whole, 14
Everything You Never Knew about Spell Books, 62
Falling Damage, 70
GAMMA WORLD, More Excerpts from the Journals, 19
Goristro Revealed, 91
Greyhawk: The shape of the world, 37
Half-Ogre, Smiling Him Hip and Thigh, 29
Hold That Person!, 90
Inner Planes: A new way to look at the AD&D world, 73
Life beyond the 15th Level, 93
Magic-user Spells, 68
Making Monsters Meaningful, 42
Melee in D&D, 24
More Cantrips, 60
More "Meat" for Greyhawk, 55
New Denizens of Devildom, 75
New Magic-User Spells, 67
Playing on the Other Planes of Existence, 32
Proper Place of Character Social Class in D&D, 25
Protection Circles and the Like, 56
Random Generation of Creatures from the Lower Planes, 23
Role-Playing: Realism vs. Game Logic, 16
Social Status and Birth Tables, 70
"Split Class" for Nimble Characters: Thief-Acrobat, 69
Talkien in DUNGEONS & DRAGONS, 13
Warhorses and Barding, 74
- Frosts** by Roger Moore, 33
- Fumble, table**
Good Hits and Bad Misses, 39
- Funerals and Other Deathly Ideas** by George Laking, 40
- Fury**
Creatures from Elsewhere, 47
- Gaining a New Experience Level** by Tom Holsinger, 10
- Game balance** by James Ward, 16
Specialization and Game Balance, 104
- Game design,** see Campaign design
- Game within a Game:** AD&D characters can battle over a chessboard, by Tim Grice, 70
- Games included in DRAGON Magazine**
Awful Green Things from Outer Space, 28
Baton Races of Yaz, 82
Crimefighters, 47
Dragonchess, 100
Elefant Hunt, 88
File 13, 72
Flight of the Boodles, 60
Food Fight, 44

- King of the Tabletop, 77
 Monsters of the Midway, 65
 Outside the Znutar, game expansion, 40
 Planet Busters, 64
 Ringside, 38
 Runngus's Game, 40
 Search for the Emperor's Treasure, 51
 Snit Smashing, 10
 Snit's Revenge, 11
- Gamma Hazards:** New mutants for the GAMMA WORLD game, by John M. Maxstadt, 85
- GAMMA WORLD**
 Artifact Use Chart, 25
 Before the Dark Years, 88
 Cavern of the Sub-Train, 52
 Change of Diet, 109
 Danger on a Budget, 99
 Don't Leave Home Without 'Em!, 91
 Exterminator, 104
 Field Guide to Lunar Mutants, 97
 First Report — Setting up the campaign, 18
 Gamma Hazards, 85
 Knowledge is Power!, 110
 More Excerpts from the Journals of Hald Sevrin, 19
 More Mutant Fever, 108
 Mutant Fever, 107
 Mutant Manual: An ARES Section Special, 98
 Mutant Manual II, 108
 Mutants, Men(?), and Machines, 75
 New Brotherhoods, 93
 New Humans, 106
 New List of Treasures to be Found, 19
 New Tools of the Trade, 97
 Of Grizzly Bears and Chimpanzees, 89
 Out of the Sun . . . ,101
 Part of GAMMA WORLD Revisited, 25
 Rites of Passage, 105
 Six-Million Dollar Mutant, 92
 StarQuestions, 86,90,95,103
 Sticks & Stones & Death Machines, 102
 Why is the Mutant Smiling?, 96
 World Gone Mad, 86
- GAMMA WORLD, More Excerpts from the Journals of Hald Sevrin** by Gary Jaquet, 19
- GAMMA WORLD: First Report — Setting up the campaign** by James Ward & Gary Jaquet, 18
- GAMMA WORLD Artifact Use Chart** by Gary Jaquet, 25
- Gandalf was Only a Fifth Level Magic-User** by Bill Seligman, 5
- GANGBUSTERS:** Designer's notes, by Mark Acres, 62
 Expanding the Genre of RPG's, 76
- Garath**
 Plethora of Paladins, 106
- Garden of Nefaron:** AD&D adventure for 7th-10th level, by Howard de Wied, 53
- Gargorian** by Michael Persinger, 101
- Gargoth, Arch-devil**, 91
- Garrot**
 New Weapons from Another "Great Mind", 64
 Or With A . . . Weird One, 61
- Gary Gygax on DUNGEONS & DRAGONS:** Origins of the Game, 7
- Gas 'em up and Smoke 'em out** by Robert Plamondon, 45
- Gates**
 From the City of Brass . . . to Dead Orc Pass, 37
- Gaund** by Ed Greenwood, 46
- Gauntlets of Heat** by David Baldwin, 91
- Gaziel, Duke of Hell**, 75
- Gem of Scroll Reading** by Nick Kopsinis, 99
- Gem of Shielding** by Richard Lucas, 99
- Gem Vars** by Michael C. Reed, 56
- Gems**
 Many Facets of Gems, 83
 Reevaluation of Gems & Jewelry in D&D, 8
- Gems Galore** by Ed Greenwood, 72
- Genetics**
 Fantasy Genetics, 44
 Half + Half Isn't Always Full, 44
 What do You Get When You Cross . . . ?, 44
- Gerda, Norse figure**, 110
- Get Out of the Medieval Rut** in "Role of Books", by Lewis Pulsipher, 81
- Getting a World info Shape** by Karl Horak, 49
- Getting in over your Head:** Sink-Or-Swim rules for the DRAGONQUEST game, by Craig Barrett, 96
- Getting into the Flow of Magic Fountains** by Tim Lasko, 34
- Ghuuna** by Tomas Willis, 89
- Giant Vampire Frog** by Alan Fomorin, 50
- Giant-sized Weapons:** The bigger the monster, the bigger the blow, by Stephen Martin, 109
- Giants**
 Giant-sized Weapons, 109
 How Heavy is My Giant?, 13
 Sea Giant, 101
- Girdle of Lions** by Ed Greenwood, 91
- Gladsheim**
 Plane Facts on Gladsheim, 90
- Glasspane Horror** by Rosemary and Don Webb, 89
- Glasya, Princess of Hell**, 75
- Glowing Globe** by Ed Greenwood, 41
- Glyphs**
 Glyphs of Cerilon, 50
 "Just" a Door? Not Any More!, 53
- Glyphs of Cerilon** by Larry DiTillio, 50
- Gnoll**
 . . . But not least: The Humanoids, 63
- Gnome**
 All about Kryn'n's Gnomes, 103
 Gnomish Point of View, 61
 Gods of the Gnomes, 61
 Race is Ahead of Class, 104
- Gnomish Point of View** by Roger Moore, 61
- Go Boldly where No Man has Gone Before:** Expanding IMPERIUM, by Robert Camino, 27
- Goblet of Glory** by Ed Greenwood, 91
- Goblin**
 . . . But not least: The Humanoids, 63
- Gods**, see Deities and demigods
- Gods of the Elves** by Roger and Georgia Moore, 60
- Gods of the Gnomes** by Roger Moore, 61
- Gods of the Halflings** by Roger Moore, 59
- Gods of the Orcs** by Roger Moore, 62
- Gods of the Suel Pantheon** by Len Lakofka
 Kord and Phaulkon, 87
 Syrul, Fortubo, and Wee Jas, 88
 Pyremius, Bellar, and Llerg, 89
 Phylon, Xerbo, and Osprem, 90
 Lydia, Bralm, and Jascar, 92
- Going for a Swim?:** Underwater action in STAR FRONTIERS gaming, by William Tracy, 110
- Going up and Getting Wet:** How DRAGONQUEST natives climb and swim, by Paul Montgomery Crabaugh, 92
- Golden ammonite** by Roger Moore, 48
- Golem, ice** by Rich Baldwin, 44
- Good DM Can Cure Bad Behavior** in "Up on a Soapbox" by Thomas Griffith, 50
- Good Evening: Are You Wild about Vampires?** by Len Lakofka, 30
- Good Hits and Bad Misses** by Carl Parlagreco, 39
- Good isn't Stupid, Paladins & Rangers, etc.** by Gary Gygax 38
- Goodberry, druid spell**, 71
- Gorgon**
 Ecology of the Gorgon, 97
- Goristro Revealed:** Big, dumb demon brought out of hiding, by Gary Gygax, 91
- Gorson, Duke of Hell**, 75
- Gospel of Benwa** by Jerome Arkenberg, 15
- Grappling**
 Brawling: The Easy Way "Out" in D&D, 11
 How to Finish Fights Faster, 83
 Without Any Weapons, 61
- Gray Mouser, character description** by Lawrence Schick and Tom Moldvay, 27
- Grease, magic-user spell**, 67
- Great Kingdom and the Knights of Doom:** Notes from the WORLD OF GREYHAWK, by Rob Kuntz, 59
- Great Stony:** Build your own cardboard castle, by Arthur Collins, 86
- Greenstone Amulet** by Ed Greenwood, 39
- Gremlin**
 Blame It on the Gremlins, 79
- Grey Dragon** by Pat Reinken, 62
- Greyhawk**, see WORLD OF GREYHAWK
- Greyhawk: The Shape of the World** by Gary Gygax, 37
- Grid, Norse figure**, 110
- Groundsquid** by Larry DiTillio, 39
- Grugach** by Gary Gygax, 67
- Gu'armor** by Bruce Barber, 101
- Guerrilla Warfare, Napoleonic Style**, by William Fawcett, 41
- Guerrilla Warfare, Napoleonic Style, Movement chart** correction, 43
- Guidelines for Mixing Campaigns:** Androids, wizards, several mutants, and liberal doses of imagination, well blended, by James Ward, 18
- Gulguthra**
 Ecology of the Gulguthra, 96
- Gullveig, Norse figure**, 110
- Gully dwarf**
 All about Gully Dwarves, 102
- Guns**, table
 Firearms, 60
- Gypsies:** A curse or a blessing — or both! by A. D. Rogan, 59
- Gypsy Train:** A moving scenario for AD&D game play, by Richard Fichera, 93
- Haldane, Kelson Cinhil, character description**
 Heroes & Villains of the Deryni, 78
- Half + Half Isn't Always Full** by Paul Montgomery Crabaugh, 44
- Half-elf, as thief**
 Race is Ahead of Class, 104
- Half-Elven Point of View** by Roger Moore, 60
- Half-ogre**
 Half-Ogre, Smiting Him Hip and Thigh, 29
 Whole Half-Ogre, 73
- Half-Ogre, Smiting Him Hip and Thigh** by Gary Gygax, 29
- Half-orc**
 Race is Ahead of Class, 104
 Tables and Tables of Troops, 99
- Half-Orcs:** They're rude and crude, and so's their point of view, by Roger Moore, 62
- Half-orcs in a Variety of Styles** by Roger Moore, 44
- Halfling**
 Elves, Dwarves & Halflings: for Appearance's Sake, 41
 Gods of the Halflings, 59
 Halfling Point of View, 59
 Race is Ahead of Class, 104
- Halfling Point of View** by Roger Moore, 59
- Hall of Mystery:** D&D adventure, by Don Turnbull, 21
- Halls of Beoll-Dur:** D&D adventure, by D. Luther, J. Naatz, D. Niessen, M. Schultz, 41
- Half! Who Goes There?:** Introducing the sentinel: an alert new NPC, by Andy Pierce, 89
- Hamadryad** by Ed Greenwood, 101
- Hammer of Penetration** by John Uustal, 99
- Hanali Celanil, lesser goddess**
 Gods of the Elves, 60
- Hand Fire, cloistered cleric spell**, 68
- Hand of Remote Action** by Ed Greenwood, 99
- Hand-held weapons**
 New Weapons from Another "Great Mind", 64
 Or With a . . . Weird One, 61
 Shield and Weapon Skills, 57
- Hand-to-hand combat**
 How to Finish Fights Faster, 83
- Handy Art of Forgery:** An assassin's pen can be mightier than his dagger, by Keith Routley, 96
- Harpoon**
 New Weapons from Another "Great Mind", 64
- Harrowhelm** by Victor Selby, 91
- Hatching is Only the Beginning:** Raising a baby dragon? Watch out for tantrums! by Colleen A. Bishop, 50
- Hate Orcs? You'll Love This Campaign** by Roger Moore, 43
- Hati Hrodvitnisson and Skoll, Norse figures**, 110
- Haunt**
 Restless Dead, 42
- Hawk/falcon**
 New Monsters for Low Levels, 66
- Hawkdragon** by Richard Stump, 101
- Hazards, natural**
 Role of Nature, 108
- He's Got a Lot to Kick About** by Philip Meyers, 53
- He's on Your Trail** by R. L. Tussey and K. Strunk, 52
- Healers** in "A Plethora of Obscure Sub-Classes" by C. Hettleston, 3
- Healing**
 Here's to Your Health, 85
 Wounds and Weeds, 82
- Heidrek, character description** by Tom Moldvay, 42
- Heironeous, Greyhawk deity**, 67
- Helm of Enemy Non-detection**
 Nasty Additions to a DM's Arsenal, 77
- Helms of Change** by Mike Billington, 40
- Henry, John, character description** by Roger Moore, 64
- Heraldry**
 Understanding Armory, 53
- Heralds of Galactus** in "The MARVEL-Phile", by Jeff Grubb, 92
- Herbs**
 Wounds and Weeds, 82
- Here's to Your Health:** Second thoughts on first aid in the AD&D game, by Kim Mohan, 85
- Hermod, Norse figure**, 110
- Hero**
 Individuals Do Make a Difference, 66
 Rewarding Heroism in D&D, 29
- Hero-deity**
 Kelanen, 71
- Herodias, Duke of Hell**, 75

- Heroes & Villains of the Deryni:** Characters spanning 200 years of fictional history, by Arthur Collins, 78
- Heward, quasi-deity**
Greyhawk's World, 71
- Heward's Mystical Organ**
Working Design for Heward's Mystical Organ, 29
- Hexes and High Guard:** Organizing space wars for TRAVELLER gaming, by Jeff Swycaffer, 104
- Hextor, Greyhawk deity,** 67
- High Tech and Beyond:** Technological improvement in TRAVELLER gaming, by James Collins, 108
- Hildebrandt, Tim**
Life — at Least Tim Hildebrandt's Vision, 49
- Hindu mythos**
Never the Same Thing Twice, 84
- Hints for D&D Judges, Part 2: Wilderness** by Joe Fischer, 1
- Hints for D&D Judges, Part 3: The Dungeons** by Joe Fischer, 2
- Hirelings Have Feelings Too** by Charles Sagui, 26
- Historical Names Make for Better Games** by Glenn Rahman, 49
- History**
Armada Disasters, 25
Armies of the Renaissance, Part I, 22
Armies of the Renaissance, Part II - The Swiss, 24
Armies of the Renaissance, Part III - Condotiere and the Papacy, 25
Armies of the Renaissance, Part IV - The English, 28
Armies of the Renaissance, Part V - Eastern Europe, 30
Armies of the Renaissance, Part VI - Landsknecht, 37
Arms and Armor of the Conquistadores, 25
Bergenhone '77: the CAT's Test of American Armor!, 24
Cavalry Plain at Austerlitz, 28
First Assassins, 22
Irresistible Force, 22
Mongols, 36
Real Barbarians, 72
35th Anniversary of D-Day Remembered, 26
Up on a Soapbox, 34
War of Flowers, 25
- History of . . .**, in "Minarian Legends", by Glenn Rahman
Dwarves, 45
Elfland, 37
Hothior, 35
Immer, 36
Mivior, 38
Muetar, 34
Port, 42
Rombune, 54
Zorn and the Goblins, 50
- History of a Game That Failed:** An essay on mistakes — and how not to make them, by David F. Godwin, 99
- History of the Shield** by Michael Kluever, 57
- Hit points**
All Good Things Must End . . . , 31
- Hobbits and Thieves in DUNGEON!** by Gary Gygax, 1
- Hobgoblin**
. . . But not least: The Humanoids, 63
- Hold That Person!** by Gary Gygax, 90
- Holy Symbol, cleric spell,** 58
- Honorable Enemy:** The ONI agency in CHAMPIONS gaming, by Gregg Sharp, 108
- Hood, Robin, character description,** 55
- Hook fauchard**
New Weapons from Another "Great Mind", 64
- Hooves and Green Hair:** Two new breeds for the AD&D magic universe, by Bennet Marks, 109
- Hop, Hop, Hooray!** More detail for B & B, by Daniel Maxfield, 45
- Horast** by Mary Lynn Skirvin, 27
- Horn of Cornucopia** by John Beck, 39
- Horn of Hades,** 28
- Horned Society**
Protection Circles and the Like, 56
- Horoscope accuracy, table**
NPCs for Hire, 45
- Horses**
Let the Horse Buyer Beware, 92
Warhorses and Barding, 74
- Horseshoe Crab, Giant** by Ed Greenwood, 89
- Horseshoes of Hades** by Victor Selby, 47
- House in the Frozen Lands:** A mid-level adventure for the AD&D game, by James Adams, 110
- How Do You Rate as a DM?:** Only your players know for sure, by DeAnn Iwan, 43
- How Do You Stop That Thing?** Or, Defending against the OGRE, by Tony Watson, 11
- How Green was My Mutant:** The appearance of humanoids in METAMORPHOSIS ALPHA, by Gary Gygax, 5
- How Heavy is My Giant?** by Shlump da Orc, 13
- How Many Coins in a Coffer?:** Don't forget, all that treasure takes up space, by David F. Godwin, 80
- How Many Ettins is a Fire Giant Worth?:** Competitive D&D, by Bob Blake, 19
- How Tall is a Giant?** in "Fantasysmith's Notebook", 31
- How Taxes Take Their Toll:** The king's collectors don't have it easy, either, by Arthur Collins, 95
- How to Ease the BOOT HILL Identity Crisis,** by Paul Montgomery Crabaugh, 46
- How to Finish Fights Faster:** A suggested simpler system for unarmed combat, by Roger Moore, 83
- How to Have a Good Time Being Evil** by Roger Moore, 45
- How to Make a Pantheon You Can Have Faith In** by Len Lakofka, 36
- How to Make the Most out of FRP Tournaments:** Guidelines to keep your group going, by Ken Ralston, 70
- How to Use Non-Prime-Requisite Character Attributes** by Wesley D. Ives, 1
- Hull Truth about Speed:** Larger ships make faster frigates, by Bruce Evry, 70
- Humanoid Races in Review** by Gregory G. H. Rihn, 44
- Humanoids**
Half-orcs in a Variety of Styles, 44
Hold That Person!, 90
Humanoid Races in Review, 44
Survival is a Group Effort, 89
- Humans, birthplaces**
Adding Depth to the Flanaess, 52
- Humans, mercenaries, fable**
Fighters for a Price, 109
- Hunting dog**
Collection of Canines, 102
- Huntsmen** by Lewis Pulsipher, 40
- Hurgeon** by Roger Moore, 94
- Hurled weapons, fable**
New Weapons from Another "Great Mind", 64
Or With a . . . Weird One, 61
Shield and Weapon Skills, 57
- Hutjijn, Duke of Hell,** 75
- Hybrids**
Half-Ogre, Smiting Him Hip and Thigh, 29
Hooves and Green Hair, 109
Whole Half-Ogre, 73
- IBIS: Profit and Peril** by Kenneth Burke, 35
- Ice Age adventuring**
Thrills and Chills, 68
- Ice golem** by Rich Baldwin, 44
- Idee**
Developments from Stonefist to South Province, 57
- Idiot Class** by Gordon Davidson, 3
- If You Meet These Monsters, Don't Let Them Bug You to Death** by Len Lakofka, 32
- Iguanadon,** 55
- Ihagnim** by Roger Moore, 89
- Illrigger**
Plethora of Paladins, 106
- Illusionist Spells: New spells** by Gary Gygax, 66
- Illusionist spells**
Advanced Illusion and Philosopher's Stone, 59
Cantrips for the Aspiring Illusionist, 61
in the Nine Hells, 76
Is It Really Real?, 66
Mighty Magic Miscellany, 1
New Look at Illusionists, 12
- Illusionists**
Familiarity Prevents Illusionists from Stealing Show, 66
New Look at Illusionists, 12
Now You See It . . . But is It Really There?, 43
Working Your Way up to First Level, 51
- Illusions**
Seeing is Believing, 105
- Ilneval**
Gods of the Orcs, 62
- IMPERIUM**
Go Boldly where No Man has Gone Before, 27
Making of a Winner, 20
Research in IMPERIUM, 39
Rules Clarifications and Addenda for IMPERIUM, 20
- Imprisonment**
Dungeons and Prisons, 23
- In Defense (Once Again) of the "Poor" Magic-User** by Michael Dodge, 34
- In Defense of Computers** by Paul Montgomery Crabaugh, 51
- In Defense of Extraordinary Characters** by Rodford E. Smith, 24
- In Gaming, Your Style Will Tell** in "Up on a Soapbox", by Lewis Pulsipher, 65
- In Search of a James Bond** by Mark Mulkins, 57
- In the Interest of Fairness** by Dr. Allen Barwick, 49
- In Trouble? Say UNCLE** by Arlen P. Walker, 74
- Incabulos, Greyhawk deity,** 71
- Incantatrix NPC**
Enchanting Incantatrix, 90
- Incubus** by Craig Stenseth, 54
- Individuals Do Make a Difference** in "Up on a Soapbox", 66
- Inflation in D&D?** by Willie Callison, 21
- Influence of J.R.R. Tolkien on the D&D and AD&D games:** Why Middle Earth is not part of the game world, by Gary Gygax, 95
- Inn**
Inns and Taverns, 29
- Inner Planes: A new way to look at the AD&D world** by Gary Gygax, 73
- Inner Planes** by Len Lakofka, 42
- Inns and Taverns,** 29
- Insanity** or, Why is my character eating leaves?, by Kevin Thompson, 18
- Insectoid**
If You Meet These Monsters, Don't Let Them Bug You, 32
- Instant Adventures:** Here are the ideas — just add imagination, by Michael Kelly, 48
- Intelligence**
Six Main Skills, 107
- Intelligence, of monsters**
Mind of the Monster, 71
- Interstellar Athletes:** A TRAVELLER game variant career, by Michael Brown, 86
- Into the Forgotten Realms:** A tournament adventure for the AD&D game, by Ed Greenwood, 95
- Invisibility**
Seeing is Believing, 105
- Irish mythos**
Return of Conan Maol, 24
- Iron Duck? Would I Kid You?** in "The MARVEL-Phile" by Jeff Grubb, 96
- Iron fan**
Or With A . . . Weird One, 61
- Iron golem**
Excerpt from an Interview with an Iron Golem, 25
- Irongate**
Developments from Stonefist to South Province, 57
- Irresistible Force:** A brief account of the rise of the Swiss Confederation, by Gary Gygax, 22
- Irritation, magic-user spell,** 67
- Is It Really Real?:** Be careful with Phantasmal Force: Illusions can kill, by Tom Armstrong, 66
- Island Enchanters** by Katharine Kerr, 52
- Istus, Greyhawk deity,** 69
- It Weighs What?!** Some notes on armor for fantasy gamers, by Michael Mornard, 23
- It's a Good Day to Die: Death Statistics of D&D Players,** by Lyle Fitzgerald, 20
- It's Not Easy Being Good** by Roger Moore, 51
- Item, magic-user spell,** 67
- Iuz**
Protection Circles and the Like, 56
- Iuz, Greyhawk deity,** 67
- Ixitxachtli**
Ecology of the Ixitxachtli, 85
- Ja-Ga-Oh: Little People of the Iroquois** by C. Froelich, 61
- Jabberwock**
Beware the Jabberwock, 54
- Jackal**
Collection of Canines, 102
- Jakalla Encounters** by Steve Klein, 4
- Jann** by Gary Gygax, 66
- Japanese Mythos** by Jerome Arkenberg, 13
- Jascar, Suel god,** 92
- Jebediah of Alcara, character description**
Heroes & Villains of the Deryni, 78
- Jericho**
Castles by Carroll III: Jericho, 70
- Jester**
A comical, clever, charismatic new NPC, 60
Character Classes to Consider, 65
New Category: Jesters!, 3
- Jewelry, table**
Re-evaluation of Gems & Jewelry in D&D, 8
- Jhessail's Silver Ring** by Ed Greenwood, 82
- John, Little, character description,** 55
- Jousting, fable**
CHAINMAIL Revisited, 17
- Joy of the Juggernaut** by William Tracy, 91
- Judging**
Hints for D&D Judges, Part 2: Wilderness, 1
Hints for D&D Judges, Part 3: The Dungeons, 2
How Many Ettins is a Fire Giant Worth?, 19
In the Interest of Fairness, 49

TSR presents

GEN CON[®] 19

Game Fair - Aug. 14-17, 1986

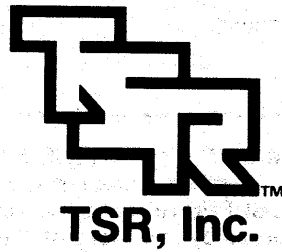

Sponsored

EVENT LISTING

**Featuring events conducted and sponsored
by TSR Staff**

Excuses, excuses ...

Well, you see, it was like this:

This year, the folks in the R&D department swore up and down that they were going to get their GEN CON® events written up and turned in to the lovely and long-suffering Marti Hayes, the Game Fair Manager, in plenty of time to meet the deadline.

But, when Marti came around to announce that the Pre-Registration Brochure was closing in two weeks, she found only a handful of events had been set. "I'm sorry," she said, "but if your events aren't in, I'll have to close the book without you."

Blind panic set in as the creative staff realized that if they didn't get some events onto the schedule, they might have to work (*shudder!*) registration . . . or even (*gasp!*) run RPGA™ tournaments! "That's too much like work!" they said, and demanded action.

The solution was the Event Listing you now hold in your hands. All the TSR Staff-sponsored events are listed herein (even the few that made it into the original Pre-Registration Brochure), along with a schedule of who will be sitting in the TSR Profiles Booth (previously known as the Designers' Booth), eagerly awaiting your questions, complaints, and requests for autographs.

All TSR staff-sponsored events are FREE (mostly because

we're already getting paid just for being there — don't you wish you were?). But if you have the odd \$100 bill, or shares of blue-chip stocks you don't need any more, we'll gladly accept additional compensation. Unmarked bills only, please, and we don't take credit cards.

Because we're late getting our events together (see above), you CAN'T PRE-REGISTER for any of our events . . . except the few that made it into the Pre-Registration Brochure, for which you may pre-register. But, hey . . . when you get your event tickets, and find that your first 45 event choices were already filled, you'll be glad that these events are still available. Say, maybe being late is okay after all. . . .

See you at the con!

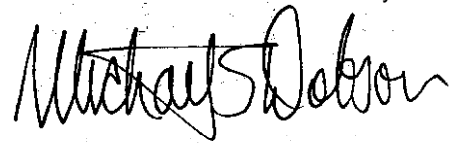

Michael Dobson
Director of Games Development

GENERAL SEMINARS

RPGA™ NETWORK MEMBERS MEETING

At this informal meeting, members can share their suggestions about everything from the Network to the individual games. Special Guest: Gary Gygax. MEMBERS ONLY. Network HQ/GM. 300 players.

Slot 12 SA at 1900 to 2245

100062 OPEN FORUM WITH GARY GYGAX

An open forum, a brief introduction and lively question and answer session ranging from D&D® gaming to role-playing world wide. Dave (Zeb) Cook and Frank Mentzer will also participate. Gary Gygax/GM.

Slot 10 SA at 1100 to 1445

100063 GREYHAWK™ ADVENTURES SEMINAR

The books . . . the world . . . An open forum by the creator himself. Gary Gygax/GM.

Slot 03 TH at 1500 to 1630

100064 **THE FINE ART OF DMing** Featuring some of TSR's top DM's in an open discussion of the do's and don'ts of DMing and guidance on how to improve your skills and satisfaction as a DM. TSR, Inc. Staff/GM.

Slot 08 FR at 1900 to 2030

100065 MARVEL QUESTIONS & ANSWERS

Questions answered and MARVEL SUPER HEROES™ Advanced Set discussed by designer Jeff Grubb and the son of Uatu himself, Harold Johnson.

Slot 11A SA at 1500 to 1630

100107 TOP SECRET® PLANS AND SCHEMES

Shhhh! Don't tell anyone, but we're doing some pretty major revisions on the game. Put on your trenchcoat, make sure you're not followed, and come to this briefing by Special Agent Doug Niles.

Slot 3A TH at 1500 to 1630

100108 ORIENTAL ADVENTURES SEMINAR

Meet the designer and chief editor of the AD&D® ORIENTAL ADVENTURES handbook, learn how you can use that fell tome to set up an Oriental campaign, and integrate it with your current AD&D campaign. Also a Q&A session. Dave (Zeb) Cook and Steve Winter/GM.

Slot 3B TH at 1700 to 1830

100109 WORLD WAR II™ SEMINAR

You've got questions about WORLD WAR II, and you need answers. General Douglas Niles and his adjutant, Ed Solters, will hold a briefing and informal discussion of the WORLD WAR II Game. Got that? Now move out!

Slot 4A TH at 1900 to 2030

100110 AD&D® 2nd EDITION SEMINAR

Your opportunity to listen, comment, and advise. Act now! This offer will not be repeated! Dave (Zeb) Cook, Frank Mentzer, Michael Dobson, Harold Johnson, and Surprise Guests.

Slot 6A FR at 1100 to 1230

100111 TELL TSR WHAT YOU WANT!

Talk back to TSR's game division about what you'd like to see in next year's product! Michael Dobson, Jeff Grubb, Dave (Zeb) Cook, Doug Niles, Bruce Heard, and others.

Slot 6B FR at 1300 to 1430

100112 SUPERHERO SEMINAR

Jeff Grubb and Roger Moore host a panel of luminaries from the world of superhero role-playing games. 'Nuff said!

Slot 7B FR at 1700 to 1830

100113 THE ORIENT FOR ROLE-PLAYERS

The designer of ORIENTAL ADVENTURES helps you translate Oriental culture and history into a new and different fantasy world. Copiously illustrated with slides from his summer vacation in Japan. Dave (Zeb) Cook/GM

Slot 9B SA at 0900 to 1030

100114 HOW TO FREELANCE FOR TSR

The people who decide if *your* game adventure is suitable for publication by TSR talk about the procedures of game design for fun and profit. Michael Dobson, Bruce Heard, Roger Moore/GM

Slot 10A SA at 1100 to 1230

100115 **A CAREER IN GAMING** From a past professional resume writer and employment consultant to the present TSR's Director of Games Development, Michael Dobson can tell you just how hard it is to start a career in gaming . . . and how you can maximize your chances for success.

Slot 5B FR at 0900 to 1030

100116 **AD&D DUNGEONEER'S SURVIVAL GUIDE SEMINAR** The latest AD&D hardcover book is all about the strange world of the Underdark. Learn how to integrate these new rules and options into your campaign. Doug Niles/GM.

Slot 11A SA at 1500 to 1630

100117 **GAME DESIGN: IS IT ART, AND IF SO, WHY CAN'T YOU FRAME IT?**

The eternal argument continues, involving top designers from several companies.

Slot 14A SU at 1100 to 1230

100118 **AD&D BATTLESYSTEM™ SEMINAR** Mercenary commanders, valiant knights, evil hordes, and the forces of darkness . . . just a few of the possibilities that will be covered. All questions answered. Doug Niles, Michael Dobson, Bruce Heard.

Slot 14B SU at 1300 to 1430

100119 **THE DRAGONLANCE® LEGENDS PLAY** A stellar evening of fantasy, music, and theatre, featuring the DRAGONLANCE® creators and their talented friends. One of the favorite events of the last two GEN CON Conventions! Doug Niles/GM.

Slot 8A FR at 1900 to 2030

Slot 12A SA at 1900 to 2030

100120 **TSR SLIDE SHOW** Visit the the innermost sanctuary of the TSR building. See game designers on coffee break! See the artists play darts! Marvel at Zeb Cook's giant robot collection! The weird, the fantastic, and the merely silly are on display in an exciting slide show hosted by TSR.

Slot 7A FR at 1500 to 1630

100125 **DRAGON FORUM** The DRAGON® Magazine staff discusses subjects concerning the publication of the magazine. This forum will cover a number of topics including the future of the magazine and policies regarding manuscript submissions. Kim Mohan, Roger Moore, and Robin Jenkins.

Slot 11B SA at 1700 to 1830

100126 **SNIPER PATROL DEMO** Man-to-man combat in the 20th century, up close and personal. Try out the new, revised, 2nd edition of these classic games before they hit the stores.

Slot 2A TH at 1100 to 1230

Slot 2B TH at 1300 to 1430

Slot 10A SA at 1100 to 1230

Slot 10B SA at 1300 to 1430

100127 **MARVEL SUPERHEROES ADVANCED** Jeff Grubb, designer of the Marvel Super Hero Advanced Set, hosts this design seminar and will take requests to design your favorite heroes for the Advanced Marvel Set.

Slot 10A SA at 1100 to 1230

BOARDGAMES

THE AWFUL GREEN THINGS FROM OUTER SPACE™ by TSR, Inc.
NOVICE

200108 **AWFUL GREEN THINGS FROM OUTER SPACE TOURNAMENT** The alien crew of the spaceship Znutar battles the Awful Green Things for control of the spaceship. Fast-moving, rollicking fun. Prizes awarded. No experience necessary.

Slot 13 SU at 0700 to 1045

SNIPER PATROL™ by TSR, Inc.
NOVICE

200086 **SNIPER™ TOURNAMENT** Man-to-man, house-to-house fighting between WWII era American and German patrols in a French village. Teams of 4 players, each with a fire team of four soldiers. Steve Winter/GM.

Slot 5 FR at 0700 to 1045

Slot 7 FR at 1500 to 1845

Slot 9 SA at 0700 to 1045

MINIATURES GAMES

AD&D® BATTLESYSTEM™ Fantasy Combat Supplement by TSR, Inc.
NOVICE

100122 **AD&D BATTLESYSTEM DEMONSTRATION** If you're tired of ordinary adventures, and long for a change of pace (plus something new to do with all those miniatures you've been accumulating), learn to play BATTLESYSTEM.

Slot 2A TH at 1100 to 1230

Slot 2B TH at 1300 to 1430

Slot 3A TH at 1500 to 1630

Slot 3B TH at 1700 to 1830

Slot 5B FR at 0900 to 1030

Slot 7A FR at 1500 to 1630

Slot 7B FR at 1700 to 1830

Slot 13B SU at 0900 to 1030

Slot 14A SU at 1100 to 1230

Slot 14B SU at 1300 to 1430

AD&D® ROLE-PLAYING GAME INTERMEDIATE

400366 **THE NIGHT OF SEVEN SWORDS** A debt of honor sends you to the ruined castle of the Clan of Seven Swords to recover an ancient jade box, which will swing the balance of power of the Temple of the Turning Wheel to the side of Warlord Michimori. A preview of the OA2 module of the same name. TSR Staff/GM.

Slot 4 TH at 1900 to 2245

OTHER GAMES

TALIS™ Card Game by TSR, Inc.
NOVICE

800169 **TALIS FATES TOURNEY** Learn to play TALIS, the card game of the DRAGONLANCE saga (featured in DL12), and participate in the first tournament of FATES, a fast, fun, and frustrating version. First round winners challenge other TALIS champions in a final showdown to find who is most favored by Fate! Jeff Grubb/GM.

Slot 7 FR at 1500 to 1945

THE TSR PROFILES BOOTH

Come meet the TSR creative staff at our booth in the Exhibit Room. Questions answered, autographs signed, complaints cheerfully heard, and suggestions carefully considered.

This schedule is current at press time, but more people are expected.

	THURSDAY	FRIDAY	SATURDAY	SUNDAY
1000 to 1400	Doug Niles Jeff Grubb Karen Martin	Anne Gray McCready Patrick Price	Doug Niles Bruce Heard	Steve Winter Harold Johnson Karen Martin
1400 to 1800	Michael Dobson Frank Mentzer Harold Johnson	Dave (Zeb) Cook Jean Black	Michael Dobson Bruce Heard	Karen Martin Ruth Hoyer Colleen O'Malley

The 6th Annual Miniatures Open

GEN CON® 19 Game Fair

Aug. 14-17, 1986, Milwaukee, Wis.

If you've painted a miniature figure that looks like a tiny petrified version of the real thing, or if you've constructed a diorama that looks like a slice out of the real world, you're invited to enter the 6th Annual Miniatures Open at this year's GEN CON® Convention. And if you want to see what the best miniature-figure painters can do, you're invited to view the entries during your stay at the convention.

Contestants should simply bring their figures or dioramas to the convention; you'll be able to register for the contest, free of charge, when you arrive on the site by asking for an entry form (or more than one; the limit is three entries per person) when you check in. Entries can be registered and dropped off with the contest organizers from 11 a.m. to 6 p.m. on Thursday, Aug. 14; 11 a.m. to 6 p.m. on Friday, Aug. 15; and 8 a.m. to noon on Saturday, Aug. 16. The figure-exhibit area will be open for public viewing during all these times as well. Entries will be placed in locked glass cabinets, and the area will be constantly supervised by convention staff members and security personnel.

The entries will be judged from noon to 3:30 p.m. on Saturday, during which time the exhibit area will be closed to spectators and contestants alike. Awards will be handed out from 3:30 to 6 p.m. on Saturday, and the area will again be open to the public at that time.

All entries must be picked up from the exhibit area between 10 a.m. and 6 p.m. on Sunday, Aug. 17; anything left in the area when it closes on Sunday will probably not be able to be reclaimed.

Ribbons will be awarded to the top four finishers in each category. In addition, the top three finishers in each category will receive certificates that can be redeemed for credit on merchandise in the Exhibition Hall. Ribbons will also be awarded to Honorable Mention entries.

Below is a summary of the categories, the definitions of what sorts of entries qualify for each group, and the amount of the merchandise-credit prizes for each category. Bring your best work, and find out how it fares in the judging — you may be better than you think!

Historical Units

Scale: Any under 40 mm.

Definition: Any recognizable military unit from any historical period.

Note: This is the *only* category that does not have to be mounted.

Prizes: \$30, \$20, \$10 credits.

Monster

Scale: Any

Definition: Any single monster.

Note: Monster is defined as any fantasy or science fiction creature not basically humanoid. Therefore dwarves, elves, etc. are *not* considered monsters.

Prizes: \$15, \$10, \$5 credits.

Fantasy, Diorama

Scale: Any under 40 mm.

Definition: Any fantasy setting. Diorama figures are fixed to one base, they are not gaming figures.

Prizes: \$30, \$20, \$10 credits.

General, Diorama

Scale: Any

Definition: Any non-fantasy setting, including historical, modern, science fiction, etc.

Prizes: \$30, \$20, \$10 credits.

Personality

Scale: Any-under 40 mm.

Definition: Any non-monster figure of any type. Although extra points may be gained for an original type of setting, it is not necessary.

Note: All figures must be mounted singularly.

Prizes: \$15, \$10, \$5 credits.

Masters single figure

Scale: Any

Definition: Any genre desired

Note: This category may only be entered by those who have been *officially* recognized as Masters in past GEN CON® Miniature Open Competitions.

Prizes: \$15, \$10, \$5 credits.

Masters diorama

Scale: Any

Definition: Any genre desired

Prizes: \$30, \$20, \$10 credits.

Junior single figure

Scale: Any

Definition: Any genre desired

Note: It must be specified by the entrant during registration that he/she is 14 years old or younger and wishes to compete only in the Junior class.

Prizes: \$15, \$10, \$5 credits.

Junior diorama

Scale: Any

Definition: Any genre desired

Note: It must be specified by the entrant during registration that he/she is 14 years old or younger and wishes to compete only in the Junior class.

Prizes: \$30, \$20, \$10 credits.

Best of show

This is awarded to a single party in recognition of all around excellence. The winner will be selected from any of the above classes.

Prize: \$20 credit.

- Judging and You!, 25
Tournament Tabulation Formula to Take the Sting Out of Scoring, 34
Judging and You! by James M. Ward, 25
- Jung Meh**
Or With A . . . Weird One, 61
- Jungle**
Civilizations: From High to Low, 31
see also Campaign design
- Jungle Fever:** Adventures in the jungle, 31
- Jungle hydra**
Ukuyatangi, the jungle hydra, 31
- Jupiter**
Seven Magical Planets, 38
"Just" a Door? Not Any More! by Len Lakofka, 53
- Katar**
Or With A . . . Weird One, 61
Keep Track of Quality by Len Lakofka, 65
Keeping the Magic-User in His Place by Ronald Pehr, 24
- Kelanen**, 71
- Kender**
All about the Kender, 101
- Keoghtom, quasi-deity**
Greyhawk's World, 71
- Keys of Sirdan** by Richard Forsten, 39
- Keys to Good SF:** Some thoughts for novice science-fiction gamers, by Sherri Gilbert, 109
- Khopesh**
New Weapons from Another "Great Mind", 64
- Khurgorbaeyag, Goblin Lesser God**
. . . But not least: The Humanoids, 63
- Kicking**
How to Finish Fights Faster, 83
- Kinetic Energy is the Key:** A brief rebuttal to the physics falling damage system, by Steven Winter, 88
- King of the Mountain:** description of strategy game, by Mike Dinicola and Mark Simmons, 44
- King of the Tabletop,** board game, 77
rules questions, 78
- Kingdom of Nyronid**
Greyhawk's World, 65
- Knights**
Chivalrous Cavalier, 72
Who Lives in That Castle?, 80
- Knights of Doom**
Great Kingdom and the Knights of Doom, 59
- Knights of Solamnia**
My Honor Is My Life, 94
- Knock, Knock!:** The history of siege warfare, by Michael Kluever, 52
- Know Your Enemy:** A guide to supervillain groups, by James Ryan, 86
- Knowing What's in Store:** Read this before your PCs' next buying spree, by Dave Rosene, 98
- Knowledge is Power!:** A skills system for GAMMA WORLD characters, by John M. Maxstadt, 110
- Koalinth (Hobgoblin),** 68
- Kobold**
. . . But not least: The Humanoids, 63
- Kochbiel, greater devil,** 91
- Koodjanuk** by Roger Moore, 44
- Kord, Suel god,** 87
- Krolli** by Todd Lockwood, 36
- Kzinti** by Robert Plamondon, 50
- Kzinti Have Landed!:** A new race for STAR TREK: The Role-Playing Game, by Jon Slobins, 104
- Labelas Enoreth, god of longevity**
Gods of the Elves, 60
- Laeral's Storm Armor** by Ed Greenwood, 39
- Landragons:** Wingless wonders of a faraway land, by Ronald Hall, 74
- Language**
Adding Depth to the Flanaess, 52
All Games Need Names, 75
Ay PronunseeAYshun Gyd, 93
Even Orcish is Logical, 75
Fantasy Philology, 66
Language Rules Leave Lots of Room for Creativity, 66
Merry Month of . . . Mirtul?, 47
New Name? It's Elementary, 72
Old Dwarvish is Still New to Scholars of Language, 66
Runes, 69
Thieves' Cant, 68
Uncommon Tongue, 109
- Language Rules Leave Lots of Room for Creativity in your Campaign** by A. D. Rogan, 66
- Languages or,** Could you repeat that in Auld Wormish? by Lee Gold, 1
- LANKHMAR game,** articles by Dr. F.C. MacKnight
Combat in the compromise game, 37
Converting the New Game into the Old Lankmar, 33
Converting to LANKHMAR in a nutshell, 34
Fafhrd-Mouser adventure in puzzle form, 38
Formative Years of "Fafhrd" and "The Mouser", 30
"MacLankmar": A Compromise Game, 36
Original Game and What It Became, 31
- Larger than Life**
Righteous Robbers of Liang Shan P'o, 54
Bogatyrs of Old Kiev, 53
- Larmacian Holy Symbol** by Richard Forsten, 39
- Lasso**
New Weapons from Another "Great Mind", 64
- Law of the Land:** Advice on making your world "legal", by Ed Greenwood, 65
- Laws of Magic:** How the AD&D universe works, and why, by Charles Olsen, 106
- Learn Magic by the Month:** DRAGONQUEST rules for studying spells, by Craig Barrett, 89
- Leeds Castle**
Castles by Carroll V: Leeds Castle, 73
- Leetah, character description**
Elfquest, 68
- Legacy of Hortus:** Fifteen of the Master's most fruitful experiments, by Jack Crane, 87
- Legions of the Petal Throne Painting Guide** by M.A.R. Barker, 6
- Lendor, Suel god,** 86
- Leomund's Lamentable Belabourment, spell,** 68
- Leomund's Plate and Cup,** 28
- Leomund's Secure Shelter, magic-user spell,** 67
- Leomund's Tiny Hut** by Len Lakofka
Adding Depth to the Flanaess, 52
Beefing up the Cleric, 58
Bureaucrats and Politicians, 74
Creating Tailor-Made Monsters, 108
Experience: by doing and learning, 35
For NPCs Only: The Death Master, 76
Good Evening: Are You Wild about Vampires?, 30
How to Make a Pantheon You Can Have Faith In, 36
If You Meet These Monsters, Don't Let Them Bug You, 32
Inner Planes, 42
"Just" a Door? Not Any More!, 53
Keep Track of Quality, 65
Magic for Merchants, 62
Missile Fire and the Archer Subclass, 45
Mission Control, 48
Monsters: How Strong is Strong?, 44
Presenting. . . the Monties, 37
Rearranging and Redefining the Mighty Dragon, 38
Recipe for the Alchemist, 49
"Segment of Action" System, 34
Shield and Weapon Skills, 57
Smoothing out Some Snags in AD&D Spell Structure, 33
Starting from Scratch, 39
Thief: A Special Look, 47
Tone Down the Demi-humans, 105
Working Your Way up to First Level, 51
- Let a Mule do It for You:** Carrying a heavy load by Robert Plamondon, 48
- Let the Horse Buyer Beware:** Separating the stallions from the swaybacks, By Robert Harrison, 92
- Let There Be a Method to Your Madness** by R. Gilbert, 10
- Let Your Town Have a Purpose or,** How to design a town in BOOT HILL, by Mike Crane, 18
- Leucrotta**
Ecology of the Leucrotta, 91
- Level Progression for Players and Dungeon Masters** by Jon Mattson, 28
- Level Titles Don't Do Justice** in "Up on a Soapbox", by John T. Saplenza, Jr., 72
- Levels**
Demi-humans Get a Lift, 95
Q: What Do You Call a 25th Level Wizard?, 21
- Lhiannan Shee** by Roger Moore, 101
- Libraries:** A sure cure for "bookworm" players who must know all, by Colleen A. Bishop, 37
- Lich**
Blueprint for a Lich, 26
- Life — At Least Tim Hildebrandt's Vision,** story and photos by Bryce Knorr, 49
- Life beyond the 15th Level** by Gary Gygax, 93
- Light worm** by Willie Callison, 61
- Lightning Bug, Giant** by Len Lakofka, 94
- Lilis, Princess of Hell,** 75
- Lilith, Princess of Hell,** 76
- Lillend** by Stephen Inniss, 94
- Lions, Tigers, & Superheroes:** Wild animals in the CHAMPIONS game, by Leonard Carpenter, 85
- Liveoak, druid spell,** 71
- Living in a Material World:** Where and how to scrounge up spell components, by Michael Dobson, 81
correction, 85
letter from author, 82
- Ljerg, Suel god,** 89
- Locals Aren't All Yokels:** In town adventurers may not hold all the aces, by Ralph Sizer, 109
- Loki, Norse god,** 110
- Look at AOKs, Old and New:** Another preview of the TOP SECRET Companion, by Merle Rasmussen, 83
- LORDS AND WIZARDS: The Placement of Castles** by Edward C. Cooper, 26
- Lost Civilizations:** A fantasy supplement for SOURCE OF THE NILE, by J. Eric Holmes, 24
- Lowdown on Wishes** by Kevin Thompson, 19
- Lower Planes**
Random Generation of Creatures from the Lower Planes, 23
- Loyal Readers: EGG answers questions** by Gary Gygax, 67
- Loyalty tables, revised**
New Loyalty Base, 107
- Luna, the Empire and the Stars:** The Moon in the OTHER SUNS game, by Niall C. Shapero, 89
- Luna: A Traveller's Guide:** The moon in the TRAVELLER game, by Marc W. Miller, 87
- Lunar High Republic:** The Moon in the SPACE OPERA game, by Edward E. Simbalist, 84
- Luthic**
Gods of the Orcs, 62
- Lyan**
Plethora of Paladins, 106
- Lycanthropy**
Other Were? Right Here!, 40
Another Look at Lycanthropy, 24
- Lycanthropy — The Progress of the Disease** by Gregory Rihn, 14
- Lydia, Suel goddess,** 92
- Lythlyx** by Ed Greenwood, 43
- MacCumhal, Finn, character description** by Roger Moore, 64
- Mace of Pain** by Thomas Zarbock, 54
- Machalas, Duke of Hell,** 75
- MacRorie, Joram, character description**
Heroes & Villains of the Deryni, 78
- Mad Merc: The Alulu Island Mission:** A tropical adventure for TOP SECRET agents, by Merle Rasmussen and James Thompson, 56
- Maedar**
Ecology of the Maedar, 106
- Magic**
AD&D's Magic System: How and Why It Works, 33
Dragon Magic, 15
Enchanting Incantatrix, 90
Laws of Magic, 106
Magic: Governed by Laws of Theory, 18
Magical Systems: Rationale and Reconciliation, 37
Many Types of Magic, 89
Spell Research the Hard Way, 37
- Magic and Science:** Are They Compatible in D&D? by James M. Ward, 1
- Magic for Merchants** by Len Lakofka, 62
- Magic fountain**
Getting into the Flow of Magic Fountains, 34
- Magic items**
Beware of Quirks and Curses, 34
Charging Isn't Cheap, 101
Creative Magic Items, 98
Five New Enchanted Objects, 86
Living in a Material World, 81
Magic of Dragon Teeth, 98
Magical Oils: Try Lotions Instead of Potions, 33
Many Ways of Getting Away, 55
Mission Control, 48
More Feather Tokens, 54
Nasty Additions to a DM's Arsenal, 77
Nine Wands of Wonder, 102
Non-violent Magic Items, 73
Random Magic Items, 57
Rings that Do Weird Things, 89
Six Very Special Shields, 89
Tarot of Many Things, 77
Treasure Trove, 91
Treasure Trove II, 99
see also Bazaar of the Bizarre, Pages from the Mages
- Magic items, Oriental**
Oriental Magic Items, 40
- Magic items, undersea**
Undersea Magic Items, 48

- Magic Items for Everyman** by Philip Meyers, 45
- Magic Mirror, magic-user spell**, 67
- Magic Mirror, illusionist spell**, 66
- Magic Munchkin** by Michael Kolakowski, 17
- Magic of Dragon Teeth**: Pull them, plant them, and stand back, by Gregg Chamberlain, 96
- Magic Resistance**: What it is and how it works, 79
- Magic spells**
- Smoothing out Some Snags in AD&D Spell Structure, 33
 - Spell Determination for Hostile Magic-Users, 19
 - Spells Can be Psionic, Too, 78
 - Lowdown on Wishes, 19
- Components**
- Living in a Material World, 81
- Research into**
- Spells between the Covers, 82
 - New Spells in D&D, 18
 - Spell Research the Hard Way, 37
 - Wizard Research Rules, 5
- Magic Stone, cleric spell**, 58
- Magic-user**
- Cast of Strange Familiars, 84
 - Casting Spells for Cash, 106
 - Everything You Never Know about Spell Books, 62
 - In Defense (Once Again) of the "Poor" Magic-User, 34
 - Keeping the Magic-User in His Place, 24
 - Laws of Magic, 106
 - New Spells in D&D, 18
 - Some Thoughts on the Speed of a Lightning Bolt, 12
 - Spells between the Covers, 82
 - Strain and Spell Casting, 29
 - Why Magic-Users and Clerics Cannot Use Swords, 16
 - Wizard with a Difference, 17
 - Working Your Way up to First Level, 51
- Alchemist subclass**
- Recipe for the Alchemist, 49
- Magic-user, non-player character**
- Brewing up a New NPC, 43
 - Spell Determination for Hostile Magic-Users, 19
 - Spelling out a Strategy for Hostile Magic-Users, 38
- Magic-user Spells** by Gary Gygax, 68
- Magic-user spells**
- Cantrips: Minor Magics for Would-Be Wizards, 59
 - Magic-user Spells, 68
 - More Cantrips, 60
 - New Magic-User Spells, 87
 - Sensible Sorcery, 21
 - Spell Determination for Hostile Magic-Users, 19
 - Systematic Magic, 19
- Magic: Governed by Laws of Theory** by Thomas A. McCloud, 18
- Magical Oils: Try Lotions Instead of Potions** by Larry Walters, 33
- Magical Systems: Rationale and Reconciliation in "Up on a Soapbox", by Kristan J. Wheaton, 37
- Magical Vestment, cleric spell**, 58
- Mail of Red Dragon Scales** by Vaughn Shepherd, 39
- Make Charisma Count for More** by Len Lakofka, 63
- Make Monsters, Not Monstrosities** by Lewis Pulsipher, 59
- Make Your Own Aliens** by Roger Moore, 51
- Making a Great Game Greater** by Glenn Rahman and Mike Carr, 34
- Making Monsters Meaningful** by Gary Gygax, 42
- Making of a Milieu**: How to start a world and keep it turning, by Arthur Collins, 93
- Making of a Winner**: Imperium — Outstanding Game of 1977, by Marc Miller, 20
- Maladomini, plane of the Nine Hells**, 76
- Malarea, greater devil**, 91
- Malbolge, plane of the Nine Hells**, 76
- Malphas, Duke of Hell**, 75
- Mammon, Arch-devil**, 75
- Man catcher**
- New Weapons from Another "Great Mind", 64
 - Or With A . . . Weird One, 61
- Man from UNCLE**
- Tracing THRUSH's Nest, 74
 - In Trouble? Say UNCLE, 74
 - Spying on the Spies, 74
- Manriki-Gusari**
- Or With A . . . Weird One, 61
- Mansion of Mad Professor Ludlow**, AD&D adventure, by James M. Ward, 42
- Mantimera** by Gregory Detwiler, 101
- Many Facets of Gems**: Stories behind the stones listed in the DMG, by Michael Lowrey, 83
- Many Shapes of the Apes**: Giving primates the attention they deserve, by Stephen Inniss, 95
- Many Types of Magic**: Whys and hows of the spell-category system, by Charles Olsen, 89
- Many Ways of Getting Away**: Methods and magic to keep your character out of the crypt, by Pat Reinken, 55
- Map Hazard, Not Haphazard**: Real topographic maps fill out fantasy worlds, by William Hamblin, 56
- Mapmaker**
- Creatures from Elsewhere, 47
- Mapping, by a thief**
- Thief: A Special Look, 47
- Maps**, see Campaign design
- Marid** by Gary Gygax, 66
- Mariner NPC**
- For Sail: One New NPC, 107
- Mars**
- Seven Magical Planets, 38
- MARVEL SUPER HEROES**
- Big Guns, 105
 - Creative Conjuring, 100
 - Defenders of the Future, 100
 - Marvelous Impossibilities, 102
 - O, Canada, 97
 - Return to the Viper's Pit, 98
 - Riders on the Storm, 110
 - S.H.I.E.L.D., 94
 - Vox-populi, 103
- MARVEL SUPER HEROES adventure**
- Sudden Dawn, 104
- MARVEL-Phile** by Jeff Grubb, 88,89,91
- All This and World War II, 104,
 - Alpha and Omega, Part I, 106
 - Alpha and Omega, Part II, 107
 - Avengers, Part II, 93
 - Back in the U.S.S.R., 99
 - Defenders Ensemble!, 100
 - Heralds of Galactus, 92
 - Iron Duck? Would I Kid You?, 96
 - Pumping Iron, Part 1, 95
 - Pumping Iron, Part 2, 96
 - Return to Asgard, 101
 - Second Annual Roster of Heroes, 109
 - Unfriendly Neighborhood Spider-Foes, 94
 - Up to Our Navels in Little Blue Geeks, 108
 - Where the Heroes Are, 98
 - Why Does It have to be Snakes?, 105
- Marvelous Impossibilities**, in "The MARVEL-Phile", by Jeff Grubb, 102
- Masers & Cameras** by Paul Montgomery Crabaugh, 51
- Material, magic-user spell**, 67
- McLain, Duncan, character description**
- Heroes & Villains of the Deryni, 78
- Mechica**: An AD&D adventure for characters of 4th-7th level, by Gali Sanchez, 70
- Medallion of Protection from Thieves**
- Nasty Additions to a DM's Arsenal, 77
- Medea, character description** by Katharine Kerr, 47
- Medusa**, see Maedar
- Meeting Demogorgon** by Jeff Spiller and Roger Moore, 36
- Meeting of the Minds**: An expanded table for psionic encounters, by Peter Zelinski, 104
- Mega-Corporations of the Frontier**: STAR FRONTIERS game background, by Kim Eastland, 90
- Melanesian mythos**
- Mythos of Oceania in DUNGEONS & DRAGONS, 29
- Melchon, Duke of Hell**, 75
- Meld into Stone, cleric spell**, 58
- Melee**
- Action in the Melee Round, 43
 - Battles above the Dungeon, 95
 - Brawling: The Easy Way "Out" in D&D, 11
 - Melee: The Intelligent DM, 67
 - Melee in D&D, 24
 - Quarterstaff Fighting Rules, 11
 - "Segment of Action" System, 34
 - Who Gets The First Swing?, 71
- Melee: The Intelligent DM** by Gary Gygax, 67
- MELEE game**
- All Fighters Are Not Created Equal, 41
 - Dueling Dragons, 41
 - Playing the Numbers, 41
 - Ready, Aim, Firearm!, 41
- Melee in D&D** by Gary Gygax, 24
- Melee weapons**
- Weapons Wear Out, Not Skills, 65
- Melf's Acid Arrow, magic-user spell**, 67
- Melf's Minute Meteors, magic-user spell**, 67
- Melt, magic-user spell**, 67
- Mentzer's Reply**: It isn't that easy, by Frank Mentzer, 49
- Mephlistopheles, Arch-devil**, 75
- Mercenaries**
- Fighters for a Price, 109
- Merchants**
- Magic for Merchants, 62
 - Sea Trade in D&D Campaigns, 6
- Merchants Deserve More, Too** by Dennis Matheson, 53
- Mercury**
- Seven Magical Planets, 38
- Merodach, Duke of Hell**, 75
- Merry Month of . . . Mirtul?** by Ed Greenwood, 47
- Messenger, cleric spell**, 58
- Messengers of God**: Angels in DUNGEONS & DRAGONS, by Stephen H. Dorneman, 17
- Metal Mimic** by Gregory Detwiler, 101
- METAMORPHOSIS ALPHA game**
- Alternate Beginning Sequence for MA, 6
 - Bionic Supplement, 13
 - How Green was My Mutant, 5
 - MA Modifications, 16
 - Notes on the Androids on the Starship Warden, 4
 - Robots as Players in MA, 14
 - Some Ideas Missed in MA, 5
 - Still More Additions to MA, 8
 - Total Person in MA, 14
 - Tribal Society and Hierarchy on Board the Starship Warden, 5
 - Water Adventures on the Starship Warden, 23
- METAMORPHOSIS ALPHA Modifications** by A. Mark Ratner, 16
- Mexican gods**
- Feathered Serpent, 2
- Micronesian mythos**
- Mythos of Oceania in DUNGEONS & DRAGONS, 29
- Mightier Than the Pen** by Kyle Gray, 46
- Mighty Magic Miscellany** by Peter Aronson, 1
- Mighty Mega-Corporations**: STAR FRONTIERS game background, by Kim Eastland, 89
- Mihali, 4**
- Military Formations of the Nations of the Universe** by M.A.R. Barker, 7
- Miller Milk Bottle** by Marc Miller, 51
- Millikan** by Mark Nuver, 89
- Mimic**
- Ecology of the Mimic, 75
- Mimir, Norse figure**, 110
- Minarian Legends**, see DIVINE RIGHT
- Minarian Variants**: Six suggestions from DIVINE RIGHT designer, by Glenn Rahman, 46
- Minnauros, plane of the Nine Hells**, 75
- Mind flayer**
- Ecology of the Mind Flayer, 78
- Mind Games**, special section on psionics, 78
- Mind of the Monster**: Give creatures the brains they were born with, by Bruce Humphrey, 71
- Mind Wrestling**: A variation of psionic combat, by Jeff Swycaffer, 23
- Miniature animals**
- New Monsters for Low Levels, 66
- Miniature Spotlight** in "Fantasysmith's Notebook", 34
- Miniatures**
- BATTLE OF FIVE ARMIES in Miniature, 1
 - BOOT HILL? Sure! But What Scale?, 30
 - D&D Ground and Spell Area Scale, 15
 - Elvish Tactics in Fantasy Miniatures, 28
 - Fantasy Miniature Rules, 1
 - Photo Finish: Lights, camera, life!, 73
 - Quick Look at Dwarves, 27
 - Reptiliad Attack, 94
 - Smile! You're on Fantasy Camera, 63
 - Star Ships and Star Soldiers, 101
 - Where the Orcs Are, 30
 - Would the Real Orc Please Step Forward?, 25
 - WRG Rules: Modifications, 32
 - Xochiyaoyotl: Pre-Hispanic Mexican Warfare, 25
- Miniatures Meet Boards**: What it means for the hobby by T. J. Kask, 26
- Mirage Arcane, illusionist spell**, 66
- Miscellaneous Treasure, Magic, Weapons, et al.**, by Gary Jaquet, 4
- Mislead, illusionist spell**, 86
- Missile Fire and the Archer Subclass** by Len Lakofka, 45
- Missile Mission**: TOP SECRET adventure, by Mike Carr, 39
- Missing Dragons**: Filling in the tints of the color wheel by Richard Alan Lloyd, 65
- Mission Control** by Len Lakofka, 48
- Mist of Rapture** by Ed Greenwood, 39
- Modem Monsters**: The perils of 20th-century adventuring, by Ed Greenwood, 57
- Moloch, Arch-devil**, 75
- Money**
- Economics Made Easy, 107
 - For the Sake of Change, 63
 - How Taxes Take Their Toll, 95

- Inflation in D&D?, 21
 Player Character and His Money, 74
Money Isn't Everything: . . . except to those poor beginning characters, by Carl Sargent, 106
Mongols: History, Weaponry, Tactics, by Michael Kluever, 36
Monk
 Defining and Realigning the Monk, 53
 He's Got a Lot to Kick About, 53
 Sage Advice, 53
 Working Your Way up to First Level, 51
Monk and Bard in DUNGEON! by Jon Pickens, 17
Monkish Combat in the Arena of Promotion by John M. Seaton, 2
Monkish Weapons & Monk vs. Monk Combat by Garry Eckert, 18
Monster level determination tables
 For Fearsome but Familiar Fiends, 34
Monster Manual
 Official Errata, 35
Monster Manual II
 New Denizens of Devildom, 75
Monster Mixing: AD&D creatures adapted to a C&S campaign, by Jon Mattson, 49
Monsters, experience point values of
 New Charts, using the "5% principle", 80
Monsters, general
 Aquatic Encounters with Megafloora, 32
 Collection of Canines, 102
 Creating Tailor-Made Monsters, 108
 Cure for the "Same-Old-Monster" Blues, 21
 Dinosaurs, 55
 Don't Look! It's a . . . 50
 For Fearsome but Familiar Fiends, 34
 If You Meet These Monsters, Don't Let Them Bug You, 32
 Make Monsters, Not Monstrosities, 59
 Making Monsters Meaningful, 42
 Many Shapes of the Apes, 95
 Mind of the Monster, 71
 Monster Mixing, 49
 Monsters: How Strong is Strong?, 44
 New Monsters for Low Levels, 66
 Random Generation of Creatures from the Lower Planes, 23
 Random Monsters, 10
 Ruins, 54
 Ups and Downs of Riding High, 50
 Wandering Monster, 15
 What is a Monster Worth?, 89
 What's That In The Water?, 68
Monsters, specific
Alcor, 101
 Allosaurus, 55
 Amiotk, 89
 Anatosaurus, 55
 Anhkheg, 5
 Ankylosaurus, 15
 Apatosaurus, 55
 Argas, 53
 Aruchai, 47
 Ascomoid, 68
 Automaton, 101
 Avari, 101
 Baku, 65
 Barghest, 26
 Basidiron, 68
 Bats, 90
 Beetle, Killer, 89
 Bichir, 89
 Bleeder, 59
 Bogeyman, 101
 Boggart, 54
 Bohun Tree, 89
 Brachiosaurus, 55
 Bulette, 1
 Burbur, 101
 Calygraunt, 89
 Cantobele, 89
 Centaur, 103
 Colfel, 56
 Cooshee, 67
 Corkie, 89
 Crawling Claw, 32
 Creeping Pit, 101
 Cryoserpent, 44
 Curs, 30
 Dark Dwellers, 51
 Deinonychus, 55
 Devas, 63
 Devil Spider, 55
 Diplodocus, 55
 Doppleganger, 80
 Dracolich, 110
 Dracones, 101
 Duleep, 89
 Dust Devil, 45
 Dyll, 55
 Explodestool, 89
 Fachan, 89
 Fire-eye Lizard, 40
 Firetail, 61
 Flailltail, 89
 Flard, 47
 Flitte, 40
 Floilte, 38
 Forchoreai, 101
 Frosts, 33
 Fury, 47
 Gargorian, 101
 Gaund, 46
 Gem Vars, 56
 Ghuuna, 89
 Giant Vampire Frog, 50
 Glasspane Horror, 89
 Golden ammonite, 48
 Gremlins, 79
 Groundsquid, 39
 Grugach, 67
 Gu'armor, 101
 Hamadryad, 101
 Hawkdragon, 101
 Horast, 27
 Horseshoe Crab, Giant, 89
 Huntsmen, 40
 Ice Golem, 44
 Iguanadon, 55
 Ithagrim, 89
 Incubus, 54
 Jabberwock, 54
 Koalinh (Hobgoblin), 68
 Koodjanuk, 44
 Krolli, 36
 Kzinti, 50
 Lhiannan Shee, 101
 Lich, 26
 Light worm, 61
 Lythlyx, 43
 Mantimera, 101
 Mapmaker, 47
 Metal Mimic, 101
 Mihalli, 4
 Millikan, 89
 Mottled (purple) Worm, 68
 Naga, Dark, 89
 Narra, 53
 Necroton, 42
 Nogra, 49
 Oculon, 53
 Orpsu, 101
 Parassaurulophus, 55
 Peltast, 89
 Pernicon, 108
 Phoenix, 47,85
 Phooka, 57
 Phycomid, 68
 Pilfer Vine, 101
 Piranha Bats, 51
 Pitcher Plant, Giant, 89
 Planetar, 64
 Plateosaurus, 55
 Poltergeist, 55
 Pooka, 60
 Prowler, 7
 Pteranodon, 55
 Quatsch, 42
 Rakshasa, 84
 Rekeiths, 94
 Remorhaz, 2
 Righteous Clay, 101
 Sand Lizard, 45
 Sandbats, 42
 Sea Demon, 48
 Sea Giant, 101
 Seastar, 89
 Scallion, 89
 Shrike, Giant, 89
 Shroom, 56
 Silkie, 41
 Sind, 89
 Skyzor'n, 45
 Solar, 64
 Spiders, 67
 Spriggan, 59
 Star Leviathan, 89
 Stegosaurus, 55
 Stroan, 54
 Stymphalian Birds, 59
 Sugo, 47
 Surchur, 55
 Tener, 101
 Teratosaurus, 55
 Thendar, 101
 Therezinosaurus, 55
 Tolwar, 43
 Tomb Tapper, 41
 Triceratops, 55
 Triffids, 53
 Tundra Beast, 101
 Tybor, 61
 Tyrannosaurus Rex, 55
 Ukuyatangi, 31
 Umbræ, 61
 Ulukku, 89
 Venus Fly-Trap, Giant, 89
 Vilkonnar, 34
 Vodyanoi, marine variety, 68
 Vriyagga, 4
 Vulturehounds, 37
 Vurgen, 89
 Water-horse, 48
 Well Spirit, 42
 Whale, Killer, 89
 Whiz-bang Beetles, 29
 Wind Steed, 89
 Wind Thrower, 101
 Wingless Wonder, 40
 Wirchler, 47
 Yale, 101
 see also Dragons, Dragon's Bestiary, Ecology articles, Featured Creatures
 Monsters: How Strong is Strong? by Len Lakofka, 44
 Monsters of Minaria in "Minarian Legends", by Glenn Rahman, 56
 Monsters of the Midway: Fantasy football game, 65
 Monty Haul campaigns, letters, 36,88
 Monuments of Minaria in "Minarian Legends", by Glenn Rahman, 55
 Moon
 Seven Magical Planets, 38
 Moonbeam, druid spell, 71
 Morale in D&D by Jim Hayes and Bill Gilbert, 6
 Morality
 Problem of Morality in Fantasy, 39
 Apples, Oranges, Role-Playing and Morality, 43
 What is Gaming's Role in Life?, 48
 Morax, Duke of Hell, 76
 Mordenkainen's Disjunction, magic-user spell, 68
 Mordenkainen's Lucubration, magic-user spell, 68
 Mordenkainen's Magnificent Mansion, magic-user spell, 68
 More "Meat" for Greyhawk by Gary Gygax, 55
 More *Dragons of Glory:* Advanced rules and extra scenarios for DL11, by Doug Niles and Tracy Hickman, 107
 More Cantrips: Mini-spells for apprentice magic-users, by Gary Gygax, 60
 More Clout for Scouts by Anthony Previte and James Cavaliere, 35
 More Feather Tokens by Ed Greenwood, 54
 More Mutant Fever: Mutant and "pure strain" GAMMA WORLD game diseases, by John M. Maxstadt, 108
 More Pages from the Mages: Latest words of wisdom from Elminster, by Ed Greenwood, 69
 More Range for Rangers: New tables for determining a PC's followers, by James A. Yates, 106
 More than a Door by Alan Miller, 41
 More, the Merrier: How clerics can "find" new followers, by Bruce Barber, 92
 Morgan, Alaric Anthony, character description
 Heroes & Villains of the Deryni, 78
 Mottled (purple) Worm, 68
 Mount, magic-user spell, 67
 Mountebank
 Character Classes to Consider, 65
 Movement table
 Beyond the Dungeon, Part I, 87
 Movement, in the Astral Plane
 Sage Advice, 71
 Muggert! by Kevin Hendryx, 26
 Multiclassed character
 All about the Druid/Ranger, 100
 Character with two classes, letter, 81

- Murlynd, quasi-deity**
Greyhawk's World, 71
- Mutant Fever:** Disease and health in the GAMMA WORLD game, by John M. Maxstadt, 107
- Mutant Manual:** An ARES Section Special, 98
- Mutant Manual II:** Reader-created mutants for GAMMA WORLD game settings, 108
- Mutants, Men(?), and Machines:** A GAMMA WORLD creature collection, by Roger Moore, 75
- My Honor Is My Life:** All about the Knights of Solamnia, by Tracy Hickman, 94
- Myrikan**
Plethora of Paladins, 106
- Mystery Hill — America's Stonehenge?** by Lynn Harpold, 7
- Mystery of the Bow** in "Fantasymith's Notebook", 35
- Mystic**
Character Classes to Consider, 65
- Myth, Legend, and Folklore** in "The Role of Books", by Lewis Pulsipher, 67
- Mythos**
Japanese Mythos, 13
Near Eastern Mythos, 16
Persian Mythos, 12
Special Skills, Special Thrills, 85
To Select a Mythos, 25
see also Norse mythos
- Mythos of Africa in D&D** by Jerome Arkenberg, 27
- Mythos of Australia in D&D** by Jerome Arkenberg, 19
- Mythos of Oceania in D&D** by Jerome Arkenberg, 29
- Mythos of Polynesia in D&D** by Jerome Arkenberg, 20
- Naga, Dark** by Ed Greenwood, 89
- Names**
All Games Need Names, 75
Historical Names Make for Better Games, 49
New Name? It's Elementary, 72
What's in a Name? As Much as You Put into It, 34
- Naming People, Places, and Things in Petal Throne** by Glenn Rahman, 24
- Naome, Princess of Hell**, 75
- Napoleonic Miniatures No Longer Mean Second Mortgage**
by Bill Fawcett, 26
- Narcisitics** by Darrel Plant and Jon Pitchford, 24
- Narra** by Jeff Goetz, 53
- Nasty Additions to a DM's Arsenal** by Richard Fichera, 77
- Natural Armor for Monsters in MONSTERS, MONSTERS** by Doug Miller, 17
- Neabaz, Duke of Hell**, 76
- Near Eastern Mythos** by Jerome Arkenberg, 16
- Necessity is the Mother of Innovation** by Rich Banner, 26
- Necklace of Alteration** by Jerome Mayard & Bill Birdsall
Five New Enchanted Objects, 86
- Necklace of Bad Taste** by David Baldwin, 91
- Necroton** by Philip Meyers, 42
- Negative Plane Protection, cleric spell**, 58
- Nergal, greater devil**, 75
- Nerull, Greyhawk deity**, 71
- Nessus, plane of the Nine Hells**, 76
- Neuschwanstein**
Castles by Carroll I. Neuschwanstein, 68
- Neutral Point of View:** Examining the territory between good and evil, by Stephen Inniss, 99
- Never the Same Thing Twice:** Filling out facts and figures on the rakshasa family, by Scott Bennie, 84
- New Avenues for Agents:** A preview of the TOP SECRET Companion, 82
- New Brotherhoods:** Minor Cryptic Alliances in GAMMA WORLD gaming, by Peter C. Zelinski, 93
- New Category: Jesters!** by Charles Carner, William Cannon & Pete Simon, 3
- New Charts, Using the "5% principle"** by Len Lakofka, 80
- New D&D Character Class: Alchemist** by Jon Pickens, 2
- New D&D Character Subclass: The Berserker** by Jon Pickens, 3
- New Denizens of Devildom:** A partial preview of Monster Manual II, by Gary Gygax, 75
- New Druid Spells. . . Naturally** by Gary Gygax, 71
- New Heights (?) in Silliness:** For TOON players, failure is half the fun, by Michael Dobson, 92
- New Humans:** Pure strain humans in the GAMMA WORLD game, by David Wainwright, 106
- New Ideas for Old Ships** by Paul Montgomery Crabaugh, 51
- New Improved Ninja** by Sheldon Price, 30
- New Jobs for Demi-Humans:** Dwarven clerics, elven rangers, and that's not all, by Gary Gygax, 96
- New List of Treasures to be Found** by Gary Gygax, 19
- New Look at Illusionists** by Rafael Ovale, 12
- New Loyalty Base:** All the tables you need, all in one place, by Stephen Inniss, 107
- New Magic-user Spells** by Gary Gygax, 67
- New Monsters for Low Levels** by Len Lakofka, 66
- New Name? It's Elementary:** Old English makes a meaningful source, by Jay Treat, 72
- New Profession for EPT: The Adventurer** by Glenn Rahman, 31
- New Ships for Old:** Redesigning starships in the SPACE OPERA game, by Stefan Jones, 93
- New Spells in D&D:** Cure for an ailing campaign or killer of a healthy one?, by Paul Sullin, 18
- New Tools of the Trade:** More artifacts for GAMMA WORLD adventurers, by Peter Giannocopoulos, 97
- New Tools of the Trade** by Jeffrey L. Gillespie, 73
- New View of Dwarves** by Larry Smith, 3
- New Weapons from Another "Great Mind"** by Gary Gygax, 64
- Nidhogg, Norse figure**, 110
- Nidus' Wand of Endless Repetition** by Ed Greenwood, 40
- Night dragon**
Landragons, 74
- Nine Hells, Part I** by Ed Greenwood, 75
- Nine Hells, Part II** by Ed Greenwood, 76
- Nine Hells Revisited:** More "facts" about devildom, by Ed Greenwood, 91
- Nine Wands of Wonder:** Wherein Elminster reveals more of the Realms, by Ed Greenwood, 102
- Ninja**
New Improved Ninja, 30
Ultimate NPC: Ninja — The DM's Hit Man, 16
- Niord, Norse figure**, 110
- Nisroch, greater devil**, 91
- Njord, Norse figure**, 110
- Nogra** by Loren Kruse, 49
- Nomenclature of Pole Arms** by Gary Gygax, 22
- Nomog-Geaya, Hobgoblin Lesser God**
. . . But not least: The Humanoids, 63
- Non-player character**
Alchemist, 45
Anti-Paladin, 39
Archer, 45
Astrologer, 45
Bandits, 63
Bureaucrats and Politicians, 74
Cloistered Cleric, 68
Creating a Cast of NPCs, 102
Death Master, 76
Duelist, 73
Encounters with Personality, 21
Gypsies, 59
Hirelings Have Feelings Too, 26
Incantatrix, 90
Ja-Ga-Oh: Little People of the Iroquois, 61
Jester, 60
Knowing What's in Store, 98
Mariner, 107
Ninja, 16, 30
Non-Player Characters have Feelings, Too, 29
Oracle, 53
Plethora of Paladins, 106
Samurai, 49
Scribe, 3, 62
Sentinel, 89
Smith, 70
Timelords, 65
Travel Works Both Ways, 105
Who Lives in That Castle?, 80
Witch, 43
- Characteristics, tables**
Non-Player Character Statistics, 18
- Magic-users**
Spell Determination for Hostile Magic-Users, 19
Spelling out a Strategy for Hostile Magic-Users, 38
- Merchants**
Magic for Merchants, 62
Sea Trade in D&D Campaigns, 6
- Non-Player Character Statistics**, 18
- Non-Player Characters Have Feelings, Too** by R. Krebs, 29
- Non-violent Magic Items:** One hundred ways to keep players guessing, by L. Pulsipher and R. Gettcliffe, 73
- Norebo, Suel god**, 86
- Norse mythos**
Dragon's Blood, 41
For Better or Worse: I, 110
For Better or Worse: II, 110
Origins of the Norse Pantheon, 29
Plane Facts on Gladshiem, 90
- Norse suns**, 39
- Not a Very Nice Guy** by Scott Bennie, 52
- Notes from a Semi-Successful D&D Player** by J. Ward, 13
- Notes from a Very Successful D&D Moderator** by Michael Crane, 26
- Notes from Another Barely Successful D&D Player** by Jeff Swycaffer, 15
- Notes from the Underground:** Tips for PARANOIA traitors, by Ken Rolston, 106
- Notes on the Androids on the Starship Warden** by James Ward, 4
- Notes on Women & Magic:** Bringing the distaff gamer into D&D, by Len Lakofka, 3
- Nottingham, Sheriff of**, 55
- Now That's Firepower!:** Machine guns & missiles in TOP SECRET gaming, by Desmond P. Varady, 102
- Now You See It. . . But is It Really There?:** Shedding light on illusions in AD&D, by Philip Meyers, 43
- NPC**, see Non-player characters
- NPCs for Hire:** One who predicts. . . by Roger Moore, 45
. . . and one who seeks the perfect mix, by Roger and Georgia Moore, 45
- Nunchaku**
Or With A . . . Weird One, 61
- O, Canada** in "The MARVEL-Phile", by Jeff Grubb, 97
- Obad-hai, Greyhawk deity**, 69
- Oceania, mythos of**
Mythos of Oceania in DUNGEONS & DRAGONS, 29
- Ochre jelly**
Ecology of the Ochre Jelly, 104
- Oculon** by Roger Moore, 53
- Of Grizzly Bears and Chimpanzees:** Mutant animal characters in the GAMMA WORLD game, by John M. Maxstadt, 89
- Of Nobles and Men:** Adventuring on Tarsus in TRAVELLER gaming, by Paul Vernon, 103
- Of the Gods** by Craig Bakey, 29
- Official Changes for Rangers:** New rules to clear up tracking and hacking, by Gary Gygax, 94
- Official Errata:** Scads of additions and revisions for AD&D, 35
- OGRE**
How Do You Stop That Thing?, 11
- OGRE, Piece by Piece** by Jerry Epperson, 17
- Oil of Phosphorescence** by Michael Persinger, 91
- Oil, flaming**
Don't Drink This Cocktail — Throw It!, 40
- Oil, magical**
Magical Oils: Try Lotions Instead of Potions, 33
- Old Dwarvish is Still New to Scholars of Language Lore** by Clyde Heaton, 66
- Old Yazirians Never Die:** Age and aging in STAR FRONTIERS gaming, by Peter C. Zelinski, 108
- Olidammara, Greyhawk deity**, 70
- One in a Million:** Notes on creating super-campaigns, by Roger Moore, 107
- Only Good Captive. . . :** is one that lives to fight another day, by Lew Pulsipher, 97
- Only Train When You Gain:** A different way to handle the in-between times, by David B. Reeder, 97
- Onnwal**
Developments from Stonefist to South Province, 57
- Open Them, If You Dare:** A dozen dweomered doors to delight DMs, by Ed Greenwood, 106
- Or With a . . . Weird One:** Stats and facts about strange new weapons for AD&D play, by Rory Bowman, 61
- Oracle:** When he talks, everybody listens, by A. Dewar, 53
- Orange dragon**
Missing Dragons, 65
- Orc**
Gods of the Orcs, 62
Would the Real Orc Please Step Forward?, 25
- Orgautha** by Ed Greenwood, 94
- Oriental Adventures**
Oriental Opens New Vistas, 104
- Oriental adventuring**
Chinese Undead, 26
- Oriental armor**
Armor of the Far East, 31
- Oriental Magic Items** by David Sweet, 40
- Oriental Opens New Vistas:** What the latest AD&D game book has to offer, by David Cook, 104
- Oriental weapons**
Weapons of the Far East, 32
- Origins of the Norse Pantheon** by Paul K. Johnstone, 29
- Orow's Inventions Can Live up your Life** by William Fawcett, 30
- Orpsu** by Ed Greenwood, 101
- Orvar-Odd, character description** by Tom Moldvay, 42
- Osprem, Suel god**, 90
- OTHER SUNS game**
Luna, the Empire and the Stars, 89
- Other Were? Right Here!** by Roger Moore, 40
- "Other" Options** by Charles Ahner and Rick Stuart, 35
- Otiluke's Resilient Sphere, magic-user spell**, 67

- Otiluke's Telekinetic Sphere**, magic-user spell, 68
- Ounce of Preparation is Worth a Ton of Paint**, in "Fantasy-Smith's Notebook", 29
- Out of the Sun . . .**: The man-machines of GAMMA WORLD gaming, by James M. Ward and Roger Raupp, 101
- Outdoor adventures**, see Campaign design: Setting
- Outer planes**, see Campaign design: Setting
- Outfitting the New Agent** by Gary Gygax, 60
- Outside the Znutar**, game expansion by Tom Wham, 40
- Overhauling the System**: A three-part remedy for problems with psionics, by Robert Schroeder, 78
- Oyster Chest** by Nick Kopsinis, 99
- Pages from the Mages**: A quartet of long-lost magical manuals, by Ed Greenwood, 62
- Pages from the Mages, More**, 69
- Pages from the Mages III**: Four more magic books, courtesy of Elminster, by Ed Greenwood, 92
- Pages from the Mages IV**: More long-lost magical lore from Elminster, by Ed Greenwood, 97
- Pages from the Mages V**: From Elminster, to Ed, to you — more lore, by Ed Greenwood, 100
- Painted Ladies & Potted Monks** in "Up on a Soapbox", by Larry DiTillio, 36
- Paladin**
- Anti-Paladin NPC, 39
 - Good isn't Stupid, Paladins & Rangers, etc., 38
 - It's Not Easy Being Good, 51
 - Plethora of Paladins, 106
 - Thou Shalt Play This Way, 51
 - Working Your Way up to First Level, 51
- Pantheon**, see Campaign design: Deities
- Para-elemental planes**
- Inner Planes: A new way to look at the AD&D world, 73
- Paradise for Painterly People** in "Fantasy-Smith's Notebook", 33
- Paramander**
- Plethora of Paladins, 106
- PARANOIA game**
- Piece of the Action, 110
 - Notes from the Underground, 106
- Parassaurolophus**, 55
- Part of GAMMA WORLD Revisited** by James Ward, 25
- Patching the Cracks in CHAMPIONS**: From creating a character to keeping a job, by Paul Montgomery Crabaugh, 73
- Patriots, Terrorists, and Spies**: More Frontier cults for STAR FRONTIERS gaming, by Kim Eastland, 109
- Patron Demons** by Lewis Pulsipher, 42
- PBM Scene**: Facts you can use when you choose what game to play, by Michael Gray, 72
- PBM Update: News & Views**: One man's perspective on the play-by-mail industry, by Mike Gray, 96
- PBM: Problems by Mail** by Michael Gray, 85
- PC**, see Player character
- Pedestal Room** by Stephen Zagieboylo, 35
- Peltast** by Ed Greenwood, 89
- Pernicon**
- Ecology of the Pernicon, 108
- Pernicon: A New Version** by John Nephew, 108
- Persian Mythos** by Jerome Arkenberg, 12
- Personalities**
- All about Elminster, 110
 - Conan, 36
 - In Search of a James Bond, 57
 - Kelanen, 71
 - see also Elminster, Larger Than Life
- Peryton**
- Ecology of the Peryton, 82
- Pet Rocks** by Roger Moore, 45
- Phantasmagoria, illusionist spell**, 66
- Phantasmal Force spell**
- Is It Really Real?, 66
 - Now You See It . . . But is It Really There?, 43
- Phantom Armor, illusionist spell**, 66
- Phantom Steed, illusionist spell**, 66
- Phantom Wind, illusionist spell**, 66
- Phaulkon, Suel god**, 87
- Philosopher's Stone**
- Advanced Illusion and Philosopher's Stone, 59
 - Elementals and the Philosopher's Stone, 27
- Phlegthos, plane of the Nine Hells**, 75
- Phoenix** by Gary Gygax, 65
- Creatures from Elsewhere, 47
- Pholtus, Greyhawk deity**, 68
- Phongor, Inquisitor of Hell**, 76
- Phooka**, 57
- Photo Finish: Lights, camera, life!** by Mike Sitkiewicz, 73
- Photographing miniatures**
- Smile! You're on Fantasy Camera, 63
- Phycomid**, 68
- Physical laws**, see Science
- Physics and Falling Damage**: Velocity is the key to understanding crash landings, by Arn Ashleigh Parker, 88
- Phyton, Suel god**, 90
- Picknose, character description**
- Elfquest, 66
- Pickpocketing**
- Was It Worth the Risk?, 104
- Piece of the Action**: A new secret society for PARANOIA gamers, by Ken Tovar, 110
- Piercer**
- Ecology of the Piercer, 72
- Pilfer Vine** by Richard Stump, 101
- Pilum (weapon)**, 104
- Piranha Bats** by David Dougher, 51
- Pit of the Oracle**: AD&D adventure, by Stephen Sullivan, 37
- Pitcher Plant, Giant** by Roger Moore, 89
- Pits** by Richard Morenoff, 15
- Pity the Poor Hobgoblin** in "Fantasy-Smith's Notebook", 32
- Plan before You Play**: Think it over, then map it out, by Ed Greenwood, 63
- Plan It by the Numbers**: A system for tailoring challenges to characters, by Frank Mentzer, 101
- Plane Facts on Gladsheim**: What it's like in the land of the Norse gods, by Roger Moore, 90
- Planes**: Concepts of spatial, temporal and physical relationships in D&D, by Gary Gygax, 8
- Playing on the Other Planes of Existence, 32
 - see also Campaign design: Setting, Elemental planes
- Planet Busters**: A game for 2-4 players, by Tom Wham & Jim Ward, 64
- Planet Busters**, note on victory, 65
- Planet Parameters** by Paul Montgomery Crabaugh, 51
- Planetar** by Gary Gygax, 64
- Planning Creative Treasures** by Dave Schroeder, 19
- Plants**
- Aquatic Encounters with Megafloa, 32
 - Legacy of Hortus, 87
 - Plants of Buirndon, 108
 - Wounds and Weeds, 82
- Plants of Buirndon**: One DM's version of specially designed greenery, by Eric W. Pass, 108
- Plateosaurus**, 55
- Play a Villain? An Evil Idea** in "Up on a Soapbox", by Brian Blume, 57
- Play's the Thing . . .** by Thomas Filmore, 11
- Play-by-mail games**
- Blueprint for a Big Game, 97
 - PBM: Problems by Mail, 85
 - PBM Scene, 72
 - PBM Update: News & Views, 96
- Player, advice to**
- Action in the Melee Round, 43
 - All for All, Not One for One, 73
 - Be a Creative Game-Player, 45
 - Be Aware and Take Care, 79
 - Druid in a Dungeon? Why Not?, 48
 - Dungeons Aren't Supposed to be "For Men Only", 57
 - Five Keys to DMing Success, 80
 - Good DM Can Cure Bad Behavior, 50
 - How to Make the Most out of FRP Tournaments, 70
 - In Gaming, Your Style Will Tell, 65
 - Notes from a Semi-Successful D&D Player, 13
 - Notes from Another Barely Successful D&D Player, 15
 - Play a Villain? An Evil Idea, 57
 - Play's the Thing . . . 11
 - Tournament Success in Six Steps, 30
 - Uncommon Tongue, 109
 - Vicarious Participant, 74
 - When Choosing a DM, Be Choosy!, 48
- Player, female**
- Notes on Women & Magic, 3
 - Points to Ponder, 39
 - Women Want Equality, and why not?, 39
- Player character**
- Alignment: A New View of the Nine Philosophies, 60
 - Assessing, Nat Guessing, 104
 - Customized Classes, 109
 - Druid in a Dungeon? Why Not?, 48
 - Gaining a New Experience Level, 10
 - How to Have a Good Time Being Evil, 45
 - Knowing What's in Store, 98
 - Locals Aren't All Yokels, 109
 - Morale in D&D, 6
 - Play a Villain? An Evil Idea, 57
 - Proper Place of Character Social Class in D&D, 25
 - Short Hops and Big Drops, 93
 - Some Thoughts on the Speed of a Lightning Bolt, 12
 - What Good PCs Are Made Of, 96
- Aging**, table, 29
- Character chart**
- Believe It or Not, Fantasy has Reality, 40
- Computer generation, program**
- What do You Get When You Cross a DM With a Computer?, 74
- Death of**
- All Good Things Must End, 31
 - Funerals and Other Deathly Ideas, 40
 - It's a Good Day to Die, 20
- Development**
- Birth Tables for D&D, 3
 - Five Keys to DMing Success, 80
 - Historical Names Make for Better Games, 49
 - New Name? It's Elementary, 72
 - Play's the Thing . . . 11
 - Room for Improvement, 107
 - Social Status and Birth Tables, 70
 - What's in a Name? As Much as You Put into It, 34
 - Who Lives in That Castle?, 80
 - Working Your Way up to First Level, 51
 - see also Abilities
- Equipment**
- When the Rations Run Out, 107
- Female**
- Dungeons Aren't Supposed to be "For Men Only", 57
 - Notes on Women & Magic, 3
 - Points to Ponder, 39
- Money**
- Player Character and His Money, 74
- Progression**
- Experience: by doing and learning, 35
 - Life beyond the 15th Level, 93
 - Money Isn't Everything, 106
 - Only Train When You Gain, 97
 - Thief's Climb Should be Leveled Out, 73
 - Ways to Handle High-level Headaches, 45
 - Working Your Way up to First Level, 51
- Size**
- Realistic Vital Statistics, 91
 - Weights & Measures, 10
- Weapons, proficiency with**
- Weapons Wear Out, Not Skills, 65
- Player Character and His Money** by Lewis Pulsipher, 74
- Players Don't Need to Know All the Rules** in "Up on a Soapbox", by Ed Greenwood, 49
- Players Handbook**
- Official Errata, 35
- Playing on the Other Planes of Existence** by Gary Gygax, 32
- Playing the Numbers** by Roberto Camino, 41
- Playing the Political Game**: A change of pace for AD&D game adventuring by Mike Beeman, 90
- Plethora of Obscure Sub-Classes**, 3
- Plethora of Paladins**: Alignment is everything to these seven NPCs by Christopher Wood, 106
- Plotting a Course for Choosy Players** by Jeff Swycaffer, 51
- Points to Ponder** by Kyle Gray, 39
- Poison**: The toxins of Cerilon by Larry DiTillio, 59
- Effective Use of Poison, 18
 - Monster venom table, 81
 - Poison, 59
 - Taking the Sting Out of Poison, 81
- Poisons from AA to XX** by Charles Sagui, 32
- Poker, Chess and the AD&D System**: The official word on what's official, by Gary Gygax, 67
- Pole arms**
- Nomenclature of Pole Arms, 22
 - Quarterstaff Fighting Rules, 11
 - Shield and Weapon Skills, 57
- Political and Military Effects of Agincourt on the Hundred Years War** by Steve Alvin, 27
- Politics**
- Bureaucrats and Politicians, 74
 - Playing the Political Game, 90
- Politics of Hell** by Alexander von Thorn, 28
- Polltergeist** by Craig Stenseth, 55
- Polynesian mythos**
- Mythos of Polynesia in DUNGEONS & DRAGONS, 20
- Pooka**: Time stands still for this critter from Celtic myth, by Michael Fountain, 60
- Pop the Clutch and Roll!**: Rules for car chases in TOP SECRET play by Ed R. Teixeira, 78
- Population**
- Survival is a Group Effort, 89
- Portent, cleric spell**, 58
- Positive Material Plane**
- Inner Planes: A new way to look at the AD&D world, 73
- Possession**
- Possessors, 42

- Demonic Possession in the Dungeon, 20
- Possessors:** A new evil . . . by Arn Ashleigh Parker, 42
- Potion of Direction** by Roger Moore, 91
- Potion of Explosions** by David Baldwin, 91
- Potion of Frost Resistance** by Michael Persinger, 91
- Potion of Mind Restoration** by Michael Persinger, 91
- Potion of Missile Protection** by Michael Persinger, 91
- Potion of Nutrition** by Michael Persinger, 91
- Potion of Pain Suppression** by Stephen Martin, 99
- Potion of Toughening** by Richard Lucas, 91
- Potions**
- New D&D Character Class: The Alchemist, 2
 - Taking the Sting out of Poison, 81
 - Treasure Trove, 91
- Potions, Psionics-boosting** by Roger Moore, 91
- Potions of Forgetfulness**, 28
- Precious stones**, see Gems
- Precipitation, magic-user spell**, 67
- Precipitation, druid spell**, 71
- Presenting . . . the Monties!** by Len Lakofka, 37
- Presenting the Suel Pantheon:** Adding to background for Greyhawk campaigns, by Len Lakofka, 86
- Preserve, magic-user spell**, 67
- Preventing Complacency in TRAVELLER Gaming** by Roger Moore, 85
- Prices for the Roaring 20's:** A way to measure PCs' purchasing power, by Glenn Rahman, 95
- Priestess**
- Witchcraft Supplement for DUNGEONS & DRAGONS, 5
- Prisoners**
- Only Good Captive. . . 97
- Probability**
- Same Dice, Different Odds, 94
 - You've Always Got a Chance, 68
- Problem of Morality in Fantasy** in "Up on a Soapbox", by Douglas P. Bachmann, 39
- Proficiency**
- Weapons Wear Out, Not Skills, 65
- Proper Place of Character Social Class in D&D** by Gary Gygax, 25
- Prophet Proofing** or, How to Counter Foretelling Spells, by David Schroeder, 21
- Prospero, character description**, 52
- Protection Circles and the Like** by Gary Gygax, 56
- Prowler**, 7
- Psionic abilities, table**
- D&D Option: Determination of Psychic Abilities, 6
- Psionics**
- And Now, the Psionicist, Astral Plane, 67
 - Deryni, 78
 - Make Charisma Count for More, 63
 - Meeting of the Minds, 104
 - Mind Wrestling, 23
 - Overhauling the System, 78
 - Potions, Psionics-boosting, 91
 - Sage Advice, 78
 - Seeing is Believing, 105
 - Spells Can be Psionic, Too, 78
- Psionics, in the Astral Plane**
- Sage Advice, 71
- Psionics is different:** . . . And that's putting it rather mildly, by Arthur Collins, 78
- Psionics Revisited** by Ronald Pehr, 24
- Psychic powers**
- D&D Option: Determination of Psychic Abilities, 6
- Psychic wind**
- Astral Plane, 67
- Psychology of the Doppelganger** by Fraser Sherman, 80
- Pteranodon**, 55
- Pulp: Paper Heroes** by Bryce Knorr, 47
- Pummeling**
- How to Finish Fights Faster, 83
 - Without Any Weapons, 61
- Pumping Iron, Part 1** in "The MARVEL-Phile", by Jeff Grubb, 95
- Pumping Iron, Part 2** in "The MARVEL-Phile", by Jeff Grubb, 96
- Purple dragon**
- Missing Dragons, 65
- Putting Together a Party on the Spur of the Moment** by Gary Gygax, 26
- Pyremius, Suel god**, 89
- Q: How much do you know about science in fantasy?** by Mike Holthaus, 60
- Q: What Do You Call a 25th Level Wizard?** A: Whatever he wants, by Brian Blume, 21
- Quaal's Feather Tokens**
- More Feather Tokens, 54
- Quarterstaff Fighting Rules** by James M. Ward, 11
- Quasi-elemental planes**
- Inner Planes, 73
- Quatsch** by Andrew South, 42
- Quest for the Midas Orb:** AD&D adventure, by Jennie Good, 61
- Quetzalcoatl**, 2
- Quick Look at Dwarves:** Organizing Dwarvish Miniature Armies, by Lance Harrop, 27
- Quickfloor** by Stephen Zagieboylo, 35
- Quill of Scroll Creation** by Victor Selby, 99
- Race**
- Appendix to "Adding Depth to the Flanaess", 52
 - Half + Half Isn't Always Full, 44
 - Half-Ogre, Smiling Him Hip and Thigh, 29
 - Race is Ahead of Class, 104
 - Tone Down the Demi-humans, 105
 - What do You Get When You Cross. . . ?, 44
 - see also Hybrids, Player character
- Race, in WORLD OF GREYHAWK**
- More "Meat" for Greyhawk, 55
 - Appendix to "Adding Depth to the Flanaess", 52
- Race is Ahead of Class:** Demi-human thieves act according to heritage, by John C. Bunnell, 104
- RAIL BARON: A Short Course for Empire Builders**, by Gary Gygax, 21
- Rainbow Pattern, illusionist spell**, 66
- Rakshasa**
- Never the Same Thing Twice, 84
- Ralishaz, Greyhawk deity**, 71
- Ran, Norse figure**, 110
- Random Encounters for BOOT HILL** by Michael Crane, 15
- Random Events Table for Settlements and/or Settled Areas** by N. Robin Crossby, 15
- Random Generation of Creatures from the Lower Planes** by Gary Gygax, 23
- Random Magic Items** by Pete Mohney, 57
- Random Monsters** by Paul Montgomery Crabaugh, 10
- Ranger**
- Good isn't Stupid, Paladins & Rangers, etc., 38
 - More Range for Rangers, 106
 - Official Changes for Rangers, 94
 - Ranger Redefined, 106
 - Working Your Way up to First Level, 51
- Ranger, elven**
- New Jobs for Demi-Humans, 96
- Ranger Redefined:** Systems for giving the class more skills, by Deborah Christian, 106
- Ransom**
- Only Good Captive. . . , 97
- Rare Way of Viewing the Wish:** High-level help comes once in a lifetime, by Lewis Pulsipher, 73
- Rare Wines and Ready Cash:** Agricultural trade in the Frontier, by Tony Watson, 93
- Rasmussen Files**, by Merle Rasmussen, 38,40,45,57,49, 51,53,57
- Ratik**
- Developments from Stonefist to South Province, 57
- Raxivort, Greyhawk deity**, 64
- Rayek, character description**
- Elfquest, 66
- Re-evaluation of Gems & Jewelry in D&D** by Robert J. Kuntz, 8
- Reaction tables, revised**
- New Loyalty Base, 107
- Read Illusionist Magic, illusionist spell**, 66
- Ready, Aim, Firearm!** by George R. Paczolt, 41
- Real Barbarians** by Katharine Kerr, 72
- "Real" Witch** by Tom Moldvay, 43
- Realism**
- Believe It or Not, Fantasy has Reality, 40
 - Role-playing: Realism vs. Game Logic, 16
 - So, You Want Realism in D&D, 8
- Realistic Vital Statistics:** A new system for figuring heights and weights, by Stephen Inniss, 91
- Realms of Role Playing:** Let's start pushing the pendulum the other way, by Gary Gygax, 102
- Rearranging and Redefining the Mighty Dragon** by Len Lakofka, 38
- Recipe for the Alchemist** by Len Lakofka, 49
- Reflecting Pool, druid spell**, 71
- Reflections of a Real-Life Cleric** by Rev. Arthur Collins, 41
- Rekeihs** by Kris Marquardt, 94
- Relief for TRAVELLER Nobility** by Paul Montgomery Crabaugh, 73
- Religion**, see Deities and demigods
- Remorhaz**, 2
- Remove Paralysis, cleric spell**, 58
- Reports Submitted to the Petal Throne** by M.A.R. Barker, 4
- Reptiliad Attack**, miniature display created by Eric Heaps, 94
- Research in IMPERIUM** by Michael Crane, 39
- Rest of the Papers:** Cleaning up a few odds and ends about centaurs, 105
- Restless Dead** by George Laking, 42
- Return of Conan Maol** by Paul Karlsson Johnstone, 24
- Return to Asgard** in "The MARVEL-Phile", by J. Grubb, 101
- Return to the Viper's Pit:** Expanding your MARVEL SUPER HEROES campaign, by Kim Eastland, 98
- Rewarding Heroism in D&D** by Doug Green, 29
- Riders on the Storm** in "The MARVEL-Phile", by Jeff Grubb, 110
- Righteous Clay** by Howard Granok, 101
- Righteous Robbers of Liang Shan P'o** by Joseph Ravitts, 54
- Rimmon, Duke of Hell**, 76
- Ring of Awareness** by Thomas Zarbock, 82
- Ring of Bladetuming** by Charles C. Craig, 82
- Ring of Energy** by Michael Persinger, 99
- Ring of Gaseous Form**
- Nasty Additions to a DM's Arsenal, 77
- Ring of Hypochondria**
- Nasty Additions to a DM's Arsenal, 77
- Ring of Icebolts** by Charles C. Craig, 82
- Ring of Infravision** by Thomas Zarbock, 82
- Ring of Invisibility Negation** by Richard Lucas, 82
- Ring of Jolting** by Charles C. Craig, 82
- Ring of Light** by Thomas Zarbock, 82
- Ring of Liquid Identification** by Craig Stenseth, 82
- Ring of Lore** by Ed Greenwood, 82
- Ring of Oak** by Roger Moore, 45
- Ring of Spell Holding** by Jeff Abbott, 82
- Ring of the Eagle** by Roger Moore, 91
- Ring of the Grasshopper** by David Baldwin, 91
- Ring of the Necromancer** by Howell, 29
- Ring of Truth** by Douglas A. Lent, 91
- Rings of Lycanthropy** by Jerome Mayard, 82
- Rings of Silence**, 28
- Rings that Do Weird Things:** Thirteen pieces of jewelry not from the DMG, 82
- RINGSIDE:** Match the pros or create your own fighters, by Brian Blume, 38
- Winnah and Still Champeen—Father Time!**, 61
- RINGWORLD game**
- Dolphins of Known Space, 95
- RISK**
- Feel Like RISKing Everything?, 34
- Rites of Passage:** Initiations for the GAMMA WORLD Cryptic Alliances by Danny Kretzer, 105
- Robin Hood** by Katharine Kerr, 55
- Robots:** Mechanical sidekicks for TRAVELLER players, by Jon Mattson, 64
- Robots as Players in METAMORPHOSIS ALPHA** by Barton Stano and Jim Ward, 14
- Rod of Melting** by Richard Lucas, 99
- Rod of Singing** by Robert Plamondon, 37
- Rods**
- Charging Isn't Cheap, 101
- Rogues of the Galaxy:** An expanded TRAVELLER character class, by Igor Greenwood, 97
- Role of Computers:** A new column devoted to gaming with software, by Hartley and Pattie Lesser, 110
- Role of Nature:** Systems for bringing environment into play, by Bruce Humphrey, 108
- Role of the Cleric:** Warriors with wisdom, by Robert Plamondon, 52
- Role-playing**
- All for All, Not One for One, 73
 - Apples, Oranges, Role-Playing and Morality, 43
 - Be Aware and Take Care, 79
 - How to Make the Most out of FRP Tournaments, 70
 - Realms of Role Playing, 102
 - Role-playing: Realism vs. Game Logic, 16
 - Vicarious Participant, 74
 - What is Gaming's Role In Life?, 48
- Role-Playing: Realism vs. Game Logic** by Gary Gygax, 16
- Roman Military Organization:** A CLASSIC WARFARE Update, by Gary Gygax, 24
- Room for Improvement:** Examining the issue of increasing ability scores, by Kim Mohan, 107
- Rovers of the Barrens**
- Protection Circles and the Like, 56
- Royal Armies of the Hyborean Age Additions** by Lin Carter and Scott Bizar, 1
- Ruby Slippers** by Robert Plamondon, 45
- Ruins:** Rotten & risky — but rewarding, by Ann Ashleigh Parker, 54
- Ruins of Andril:** An AD&D adventure for 8th-11th levels, by Ian Melliush, 81
- Rules Clarifications and Addenda for IMPERIUM** by Marc Miller, 20

Rumjal, greater devil, 91
Rummele by Stephen Inniss, 94
Run, magic-user spell, 67
RUNEQUEST
 Artifacts of Dragon Pass, 40
 Worshippers of Ratar, 51
Runes by Phil Taterczynski and Roger Raupp, 69
Runestones by Ed Greenwood, 69
Runngus's Game by Tom Wham, et al., 40
Rust Dust by Woodrow Smith
 Five New Enchanted Objects, 86
Rust monster
 Ecology of the Rust Monster, 88

Sabratact
 Score One for Sabratact, 100
Sacrifices
 Sense of Sacrifices, 52
Sage Advice, 32, 33, 34, 42, 36, 31, 35, 47, 44, 37, 78, 79, 39, 94, 66, 64, 60, 52, 43, 48, 46, 62, 76, 54, 53
Sage Advice: Solid answers to astral questions, by Roger Moore, 71
Sai
 Or With A . . . Weird One, 61
Saint
 Settling Sainly Standards, 79
St. Cuthbert, Greyhawk deity, 67
Same Dice, Different Odds.; Divided rolls add variety and uncertainty, by David G. Weeks, 94
Samurai
 Loyal Readers: EGG answers letters, 67
 Samurai!, 49
 in "A Plethora of Obscure Sub-Classes", by Mike Childers, as modified by Jeff Key, 3
SAMURAI: Honorable designer speaks!, by Dan Campagna, 36
Samurai!: An honorable NPC, by Anthony Salva, 49
Sand Lizard by Marcella Peyre-Ferry, 45
Sandbats by Jon Mattson, 42
Sap
 New Weapons from Another "Great Mind", 64
Saturn
 Seven Magical Planets, 38
Satyr
 Hooves and Green Hair, 109
Saurians: A new race for STAR FRONTIERS campaigns, by Jeffrey Bouley, 103
Savant
 Character Classes to Consider, 65
Saved by the Cavalry!: An army of knowledge for BOOT HILL players, by Carl Smith, 76
Saving throw
 Insanity, 18
 New Charts, Using the "5% principle", 80
Saving throw, against illusions, table
 Familiarity Prevents Illusionists from Stealing Show, 66
Saving throw, against poison
 Poison, 59
Scallion by Ed Greenwood, 89
Scarlet, Will, character description, 55
Scepter of Defense by Susan Lawson, 86
Schardenzar's Story in "Minarian Legends", by Glenn Rahman, 51
Scholar, character description, by Patricia LaPointe, 17
Science
 Kinetic Energy is the Key, 88
 Magic and Science, 1
 Physics and Falling Damage, 88
 Q: How much do you know about science in fantasy?, 60
Science fiction games
 Thousand in One, 102
 Star Ships and Star Soldiers, 101
 Guidelines for Mixing Campaigns, 18
 Keys to Good SF, 109
Scintillating dragon
 Landragons, 74
Score One for Sabratact: New sport combines targets with teamwork, by Forest Baker, 100
Scribe: Non-player character by Ed Greenwood, 62
Scribes: New Specialist Described, in "A Plethora of Obscure Sub-Classes", by David Mumper, 3
Scroll, cloistered cleric spell, 68
Scroll of Domination by David Baldwin, 91
Scroll of Suggestion by David Baldwin, 91
Scrolls
 Treasure Trove, 91
Scythe, battle
 Or With A... Weird One, 61
Sea Demon by Ernest N. Rowland, Jr., 48
Sea Giant by Gregg Chamberlain, 101

Sea Lion
 Ecology of the Sea Lion, 107
Sea Trade in D&D Campaigns by Ronald C. Spencer, Jr., 6
Seal of the Imperium by M.A.R. Barker, 9, 11
Search for the Emperor's Treasure, game by Tom Wham, 51
SEARCH FOR THE NILE Revisited: Designer's notes, addenda, clarifications & response, by D. Wesely, 21
Seastar by Ed Greenwood, 89
Second Annual Roster of Heroes in "The MARVEL-Phile", by Jeff Grubb, 109
Second Volley: Taking another shot at firearms, AD&D style, by Ed Greenwood, 70
Secret Page, magic-user spell, 67
See Africa and Die! or, Mr. Stanley, meet Dr. Livingstone, by Gary Gygax, 20
Seeing is Believing: Examining the three varieties of invisibility, by Geoffrey Meissner, 105
Seek, But Don't Expect to Find by Karl Horak, 47
"Segment of Action" System Takes AD&D Melee One Step Further by Len Lakofka, 34
Segojan Earthcaller
 Gods of the Gnomes, 61
Self Defense for Dragons: Everyone's favorite foe gets a fighting chance, by Gregory Rihn, 50
Sending, magic-user spell, 68
Sense of Sacrifices by Douglas Loss, 52
Sensible Sorcery by Ronald Pehr, 21
Sentinel NPC
 Halt! Who Goes There?, 89
Sepia Snake Sigil, magic-user spell, 67
Sequester, magic-user spell, 68
Setting Sainly Standards: Friends of the gods deserve special powers, by Scott Bennie, 79
Seven Magical Planets by Tom Moldvay, 38
Seven Swords: Blades of the Realms, by Ed Greenwood, 74
Seventeen New Treasures, 99
SF "Universe": An in-depth examination of the STAR FRONTIERS game, by Tony Watson, 74
Shadow Walk, illusionist spell, 66
Shargaas
 Gods of the Orcs, 62
Sharp System for Swords: Magic blades get more personality and purpose, by Pete Mohney, 99
Sheela Peryroyl
 Gods of the Halflings, 59
S.H.I.E.L.D.: a MARVEL SUPER HEROES game supplement, by William Tracy, 94
Shield
 History of the Shield, 57
 Keep Track of Quality, 65
 Or With A . . . Weird One, 61
 Shield and Weapon Skills, 57
 Six Very Special Shields, 89
Shield and Weapon Skills by Len Lakofka, 57
Shield of Dragon Protection by John Uustal, 99
Ships
 Hull Truth about Speed, 70
Shoosuva, gnomish undead guardian
 . . . But not least: The Humanoids, 63
Short Course in D&D by Dan Bromberg, 28
Short History of Adamantite by Charles Sagui, 17
Short Hops and Big Drops: Here's how far and how high characters can jump, by Stephen Inniss, 93
Should They Have An Edge? No: Rule restrictions on weapon usage are firm and fair, by Bruce Humphrey, 66
Should They Have An Edge? Yes: Spell-users should be able to use "forbidden" weapons, by John Sapienza, 66
Shout, magic-user spell, 67
Shrike, Giant by Ed Greenwood, 89
Shroom by Lew Pulsipher, 56
Shurikin
 Or With A . . . Weird One, 61
Siege warfare
 Fights of Fantasy, 79
 Knock, Knock!, 52
Sights and Sounds in DUNGEONS & DRAGONS by Robert Dushay and Michael Weisberg, 17
Sigurd Fafnirsbane, character description by T. Moldvay, 41
 Silkie by Tom Moldvay, 41
Silver Twin!: High-tech crimefighters of the Frontier, by Michael Therrien, 102
Simulating the Cavalry Plain by Bill Fawcett, 28
Sind by Ed Greenwood, 89
Singing a New Tune: A different bard, not quite so hard, by Jeff Goetz, 56
Singing Sword by Ed Greenwood, 41
Sink, magic-user spell, 68
Six Guns & Sorcery by Allen Hammack, 28

Six Main Skills: What AD&D game abilities mean in real terms, by Jefferson P. Swycaffer, 107
Six Very Special Shields: More magic items from the mind of Elminster, by Ed Greenwood, 89
Six-Million Dollar Mutant: Cyborgs in the GAMMA WORLD game, by Bruce Humphrey, 92
Size, see Player character
Skadi, Norse figure, 110
Skeleton Crew: Down to the Bare Bones in "FantasySmith's Notebook", 36
Skeletons, animal
 New Monsters for Low Levels, 66
Skills for the Super Agent: Agent skill packages in the CHAMPIONS game, by Gregg Sharp, 90
Skull Mace by Roger Moore, 54
Skywise, character description
 Elfquest, 66
Skyzorr'n by Jon Mattson, 45
Slave Pits Revisited: Suggestions for saving the AD&D Open, by Philip Meyers, 49
Slithering tracker
 Ecology of the Slithering Tracker, 86
Slow Poison, druid spell, 71
Smaller Than Man-Sized Weapons Table by Thomas Holsinger, 29
Smile! You're on Fantasy Camera, story by Bryce Knorr, photos by Darlene Kay Blanchard, 63
Smith: Test the metal of this NPC, by Ed Greenwood, 70
Smoothing Out Some Snags in AD&D Spell Structure by Len Lakofka, 33
Snit Smashing, game, 10
 From the Chronicles of Emaj the Rotund, 11
SNIT'S REVENGE, game by Tom Wham, 11
 Bolotomus' Revenge, 34
 Runngus's Game, 40
So, you Want Realism in D&D? by Brian Blume, 8
Social class
 'Caste' of Real Characters, 70
 Proper Place of Character Social Class in D&D, 25
Social Status and Birth Tables by Gary Gygax, 70
Society for Creative Anachronism by Allen Hammack, 24
Solar by Gary Gygax, 64
Solid Fog, illusionist spell, 66
Solo Berserker for WILLIAM THE CONQUEROR — 1066 by James McMillan, 26
Solo scenario: One-player parties are fun for two, by Katharine Kerr, 73
Solonor Thelandira, god of archery
 Gods of the Elves, 60
Some Ideas Missed in METAMORPHOSIS ALPHA by James M. Ward, 5
Some Spells for the Very Smart Sorcerer by B. McMillan, 32
Some Thoughts on the Speed of a Lightning Bolt by James Ward, 12
Some Universal Rules: Making your own campaign — and making it work, by Roger Moore, 53
Sorry, Wrong Dimension!: Dimensional travel for super-powered gaming, by Mike Manolakes, 67
Souping up the Spider by Gregg Chamberlain, 67
SOURCE OF THE NILE
 Flow Charts, 29
 Lost Civilizations, 24
 See Africa and Die!, 20
South Province
 Developments from Stonefist to South Province, 57
SPACE MARINES: Designer's comments, corrections and addendum, by A. Mark Ratner, 14
SPACE OPERA game
 Fighting the Good Fight, 109
 Lunar High Republic, 84
 New Ships for Old, 93
Special Knowledge and a Bureau For Infiltrators by Gary Gygax, 61
Special Skills, Special Thrills: Varying powers helps avoid cleric stereotypes, by Roger Moore, 85
Specialization and Game Balance by Len Lakofka, 104
Spell books
 Everything You Never Knew about Spell Books, 62
 Spells between the Covers, 82
 see also Pages from the Mages
Spell casting
 Action in the Melee Round, 43
 Living in a Material World, 81
 Strain and Spell Casting, 29
Spell Determination for Hostile Magic-Users or, Why did he throw that spell? by Steve Miller, 19
Spell point system
 Strain and Spell Casting, 29
Spell Research, the Hard Way: Making new magic takes lots of time, by T. I. Jones, 37

- Spellbook of a magic-user**, table, 28
- Spelling out a Strategy for Hostile Magic-Users** by Jon Mattson, 38
- Spells between the Covers**: Details for delving into magical research, by Bruce Heard, 82
- Spells Can be Psionic, Too**: How and why magic resembles mental powers, by Kim Mohan, 78
- Spicing Up STELLAR CONQUEST**: How to add native life and "fate" to your worlds, by Tony Van Liew, 31
- Spider**
Souping up the Spider, 67
- Spike Growth, druid spell**, 71
- Spike Stones, druid spell**, 71
- Spiked buckler**
New Weapons from Another "Great Mind", 64
- Spindrift Isles**
Greyhawk's World, 65
- Spined devils**, 75
- "Split Class" for Nimble Characters: Thief-Acrobat** by Gary Gygax, 69
- Spook, illusionist spell**, 66
- Strigyan** by Roger Moore, 59
- Spy's Advice**: Questions and answers on the TOP SECRET game, by various authors, 57,67,72,77,91,104, 105,107
- Spying on the Spies** by Arlen P. Walker, 74
- SQUAD LEADER scenarios**
Fall of Sevastopol by Bryan Beecher, 43
Fighting in the Streets by Bryan Bullinger, 36
Large-scale streetfighting by Bryan Bullinger, 37
Skirmish in Austria by Bryan Beecher, 45
The Battles for Warsaw, 40
'Two Eyes for an Eye' by Bryan Beecher, 47
- Staff of Ethereal Action** by Ed Greenwood, 47
- Staff of Spell Focusing** by Richard Lucas, 91
- Staff of the Couatl** by Pat Reinken, 86
- Staff sting**
New Weapons from Another "Great Mind", 64
Or With A . . . Weird One, 61
- Stalemate at Kassala** by John Gosling, 22
- Standard Divine Abilities**, table, 68
- Standardization vs. Playability** in "Up on a Soapbox", by Bob Bledsaw, 30
- STAR FRONTIERS**
Blastoff!, 65
Careers in Star Law, 91
Coming of the S'sessu, 96
Expanding the Frontier, 105
Fast and Deadly, 96
"Freeze! Star Law!", 87
From Anarchy to Empire, 94
Going for a Swim?, 110
Mega-Corporations of the Frontier, 90
Mighty Mega-Corporations, 89
Old Yazirians Never Die, 108
Patriots, Terrorists, and Spies, 109
Rare Wines and Ready Cash, 93
Saurians, 103
SF "Universe", 74
Silver Twin!, 102
Star Law Returns, 104
StarQuestions, 85,88,92,98
Tanks a Lot!, 99
Tanks Again!, 103
"Tote that Barge!", 107
Vulturus Connection, 98
Yachts and Privateers Return, 88
Zethra, 84
Zuraqor Strike Back!, 95
- STAR FRONTIERS adventure**
Battle of Ebony Eyes, 88
Joy of the Juggernaut, 91
- Star Law Returns**: A new look at a STAR FRONTIERS agency, by Matt Bandy, 104
- Star Leviathan** by Roger Moore, 89
- Star Ships and Star Soldiers**: Miniatures in science-fiction gaming, by Roger Moore, 101
- STAR TREK: The Role-Playing Game**
Federation Guide to Luna, 85
Kzintii Have Landed!, 104
These are the Voyages of Ginny's Delight, 96
- STARFIRE Gaming x 3**: Three variations on space combat and movement by Jerry Epperson, 84
- Starkad, character description** by Tom Moldvay, 41
- Starshine, druid spell**, 71
- STARSHIP TROOPERS**
And What of the Skinnies?, 26
- Starting from Scratch** by Len Lakofka, 39
- Steel Dragon** by Pat Reinken, 62
- Stegosaurus**, 55
- STELLAR CONQUEST**
Spicing Up STELLAR CONQUEST, 31
Tactics of Diplomacy in STELLAR CONQUEST, 10
Examining Movement Tactics, by Edward C. Cooper, 15
- STELLAR CONQUEST for Two**: The Perseid War, by Steve Jackson, 36
- Stellar Diocese**: The clergy in the TRAVELLER universe, by Michael Brown, 101
- Step-by-step System for Urban Encounters** by Jeff Swycaffer, 37
- Sticks & Stones & Death Machines**: Balancing the GAMMA WORLD encounter tables, by John M. Maxstadt, 102
- Sticks, Stones, and Bones**: Weapons to use when the enemy swipes your sword, by Stephen Inniss, 97
- Still More Additions to MA** by James Ward, 8
- Stirge**
Ecology of the Stirge, 83
- Stone of Mysterious Sounds** by Nick Kopsinis, 99
- Stoneskin, magic-user spell**, 67
- Strain and Spell Casting** by Kevin Thompson, 29
- Strategy of Survival** by Edward C. Cooper, 18
- Strength**
Monsters: How Strong is Strong?, 44
Six Main Skills, 107
Weights & Measures, 10
- Strength Comparison Table** by Thomas Holsinger, 26
- Stroan** by Ed Greenwood, 54
- Stygia, plane of the Nine Hells**, 75
- Stymphalian birds** by Michael Parkinson, 59
- Succor, magic-user spell**, 68
- Sudden Dawn**: A MARVEL SUPER HEROES module, by William Tracy, 104
- Sugo**
Creatures from Elsewhere, 47
- Sumerian gods**
Near Eastern Mythos, 16
- Sun**
Seven Magical Planets, 38
- Sunndi**
Developments from Stonefist to South Province, 57
- Sunray, druid spell**, 71
- Super Spies** by Allen Hammack, 44
- Superhero games**
Crusading Life, 107
Know Your Enemy, 86
One in a Million, 107
Sorry, Wrong Dimension!, 101
- SUPERWORLD Game, Expanded**: New powers, advantages and handicaps, by Steve Perrin, 90
- Surchur** by Jeff Brandt, 55
- Surefire Strategy for the Third Reich**: The Nazis get even nazier, by William B. Searight, 31
- Survival is a Group Effort**: The effects of population growth and regrowth, by Stephen Inniss, 89
- Survival Tips for the Slave Pits** by Dave Cook, 43
- Sword, Cursed Everstriking** by Stephen Martin, 91
- Sword, falchion**
New Weapons from Another "Great Mind", 64
- Sword, khopesh**
New Weapons from Another "Great Mind", 64
- Sword, magic**
Blades With Personality, 109
Mightier Than the Pen, 46
Seven Swords, 74
Sharp System for Swords, 99
Singing Sword, 41
Treasure Trove, 91
Treasure Trove II, 99
- Sword of Assassination** by Bruce E. Wright, 91
- Sword of Cowardice** by David Baldwin, 91
- Sword of Insanity** by David Baldwin, 91
- Sword of Intercession** by Stephen Martin, 91
- Sword of Justice, D&D game adventure**, by Jon Mattson, 92
- Sword of Night, +1** by Stephen Martin, 91
- Swords**
Clerics, Take Note: "No Swords" means NO Swords!, 33
Why Magic-Users and Clerics Cannot Use Swords, 16
- Syrar's Silver Sword** by Ed Greenwood, 47
- Syruul, Suel god**, 88
- SYSTEM 7 NAPOLEONICS**
Designer Responds to First Volley, 26
Miniatures Meet Boards, 26
Napoleonic Miniatures No Longer Mean Second Mortgage, 26
Necessity is the Mother of Innovation, 26
- Systematic Magic**: Revised Magic Tables by Robin W. Rhodes, 19
- Tables and Tables of Troops**: Many factors affect followers for fighters, by James Yates, 99
- Tactics of Diplomacy in STELLAR CONQUEST** by Edward C. Cooper, 10
- Tailor-Made Treasure**: Develop different hoards for different dragons, by Roger Moore, 98
- Take the Plunge!**: Watery words to the wise, by Jeff Swycaffer, 48
- Taking the Sting Out of Poison**: Another view on how to use toxic cocktails, by Chris Landsea, 81
- Taming of Brimstone**: A BOOT HILL module, by Donald Mumma, 71
- Tanks a Lot!**: Vehicle combat in STAR FRONTIERS gaming, by Alex Curylo, 99
- Tanks Again!**: More material on STAR FRONTIERS vehicle weapons, by Alex Curylo, 103
- Tarot of Many Things** by Michael J. Lowrey, 77
- Tarot**
Deck of Fate, 26
- Tasha's Uncontrollable Laughter, magic-user spell**, 67
- Taunt, magic-user spell**, 67
- Teleport Without Error, magic-user spell**, 68
- Teleporters**
"Just" a Door? Not Any More!, 53
- Temple of Poseidon**: AD&D adventure, by Paul Reiche III, 46
- Tempus Fugit, illusionist spell**, 66
- Tener** by Stephen Inniss, 101
- Teratosaurus**, 55
- Tesseract: Which Way is Up? Well, it all depends . . .**, by Allen Wells, 38
- Tesseract: A TRAVELLER Artifact**, by Gary Jordan, 27
- Tesseract or, Making meticulous mapmakers mad**, by Gary Jordan, 17
- That "Other" Dungeon** by Timothy Jones, 21
- That's Life in the Big City**: Advice on creating authentic urban environments, by Kevin Anderson and Kristine Thompson, 99
- That's No Pizza — It's the Pong Papers!** by James (Pong) Thompson, 65
- That's Not in the Monster Manual!**: Neutral dragons: Six new challenges for powerful players, by Arthur W. Collins, 37
- "The Item You Want is Temporarily out of Stock . . ."** in "The Rasmussen Files", by Merle Rasmussen, 53
- Thendar** by Douglas Lent, 101
- Therizinosaurus**, 55
- These are the Breaks**: Weapon damage in AD&D action, by John R. Shaw, 54
- These are the Voyages of Ginny's Delight . . .**: An adventuring starship for STAR TREK: Role-Playing Game, by Dale L. Kemper, 96
- Thief**
Race is Ahead of Class, 104
Thief: A Special Look, 47
Thief's Climb Should be Leveled Out, 73
Thieves' Cant, 66
Was It Worth the Risk?, 104
Well-Rounded Thief, 104
Working Your Way up to First Level, 51
- Thief-acrobat**
Loyal Readers: EGG answers questions, 67
"Split Class" for Nimble Characters: Thief-Acrobat, 69
- Thief: A Special Look** by Len Lakofka, 47
- Thief's Climb Should be Leveled Out** by John T. Sapienza, Jr., 73
- Thieves' Cant**: A primer for the language of larceny, by Aurelio Locsin, 66
- THEEVES' GUILD: Designer's notes**, by Richard Meyer and Kerry Lloyd, 54
- This Here's Tyrannosaurus Tex** by Roger Moore, 46
- This Land is My Land . . .** by Douglas Loss, 52
- Thou Shalt Play This Way**: Ten commandments for paladins, by Robert J. Bezold, 51
- Thousand in One**: Tips for expanding your interstellar campaign, by Mark Graham Jones, 102
- Three Challenges in One**: New module mixes wargaming and role-playing, by Michael Dobson, 104
- Three Cheers for Beowulf**: Different portraits of the legendary hero, by R. Cooke, R. Moore, K. Gray, 85
- Three Kindreds of the Eldar** by Larry Smith, 1
- Thrill of the Hunt**: DRAGONQUEST rules for finding 'fresh' food, by Paul Montgomery Crabaugh, 78
- Thrills and Chills**: Ice age adventures, by Arthur Collins, 68
- THRUSH**
Tracing THRUSH's Nest, 74
- Thuryn, Rhys, character description**
Heroes & Villains of the Deryni, 78
- Tiamat**
Dragons and Their Deities, 86
Rearranging and Redefining the Mighty Dragon, 38
- Time elemental**
Deities and Demigods of the World of Greyhawk, 69

Timelords: An NPC class for the future, present & past, by Lewis Pulsipher, 85

TIMEMASTER
When History Goes Awry, 98

Titivilus, Duke of Hell, 75

To Err is Human, to Repair Divine in "Up on a Soapbox", by Lewis Pulsipher, 52

To Select a Mythos by Bob Bledsaw, 25

Tolkien in DUNGEONS & DRAGONS by Rob Kuntz, 13

Tolkien, J.R.R.
Influence of J.R.R. Tolkien on the D&D and AD&D games, 95
Tolkien in DUNGEONS & DRAGONS, 13

Tolwar by Todd Lockwood, 43

Tomb Tapper by Ed Greenwood, 41

Tombs & Crypts by James M. Ward, 9

Tone Down the Demi-humans by Len Lakofka, 105

TOON
New Heights (?) in Silliness, 92

TOP SECRET
Administrator's Advice, 109
After the Blast, 98
Agencies and Alignments, 93
Agents and A-Bombs, 108
Authentic Agencies, Part I, 97
Authentic Agencies, Part II, 98
Authentic Agencies, Part III, 99
Basic Bureaus and Special Agents, 47
Beefing up the Bureaus, 89
College Courses and Vital Statistics, 51
Danger: This Document is Loaded, 49
From Spy World to Sprechenthaltestelle, 40
In Search of a James Bond, 57
Look at AOKs, Old and New, 83
New Avenues for Agents, 82
New Tools of the Trade, 73
Now That's Firepower!, 102
Outfitting the New Agent, 80
Pop the Clutch and Roll!, 78
Special Knowledge and a Bureau For Infiltrators, 81
Super Spies, 44
That's No Pizza — It's the Pong Papers!, 85
TOP SECRET Reactions and Rule Additions, 45
Undercover Job Guide, 52
see also **Rasmussen Files, Spy's Advice**

TOP SECRET adventure
Chinatown: The Jaded Temple, 62
Doctor Yes, 48
Mad Merc: The Alulu Island Mission, 56
Missile Mission, 39
Wacko World, 79
Whiteout, 87

TOP SECRET Reactions and Rule Additions in "The Rasmussen Files", by Merle Rasmussen, 45

Torment, magic-user spell, 68

Tortach, Duke of Hell, 78

Total Person in METAMORPHOSIS ALPHA by James M. Ward, 14

"Tote that Barge!": A short guide to interstellar economics, by Malt Bandy, 107

Tournament
Different Design, 108
How Many Ettins is a Fire Giant Worth?, 19
How to Make the Most out of FRP Tournaments, 70
In the Interest of Fairness, 49
Into the Forgotten Realms, 95
Mentzer's Reply, 49
Slave Pits Revisited, 49
Survival Tips for the Slave Pits, 43
Tournament Success in Six Steps, 30
Tournament Tabulation Formula to Take the Sting Out of Scoring, 34
Twofold Talisman, Adventure One: Heart of Light, 84
Twofold Talisman, Adventure Two: The Ebon Stone, 85

Tournament Success in Six Steps by Jon Pickens, 30

Tournament Tabulation Formula to Take the Sting Out of Scoring by Jon Mattson, 34

Tower of London
Castles by Carroll IV: The Tower of London, 72

Town adventure, see Campaign design: Setting

Tracing THRUSH's Nest by Arlen P. Walker, 74

Tracking
Official Changes for Rangers, 94

Translate, cloistered cleric spell, 68

Translating Skierbugging Into TRAVELLER by Steve Winter, 59

Transmute Water To Dust, magic-user spell, 68

Transmute Water to Dust, druid spell, 71

Trapper
Ecology of the Trapper, 84

Traps
Beware of Quirks and Curses, 34
Dastardly Deeds & Devious Devices, 34,35
"Just" a Door? Not Any More!, 53
More than a Door, 41
Open Them, If You Dare, 108
Pedestal Room, 35
Pits, 15
Quickfloor, 35

Travel and Threads for DRAGONQUEST by Paul Montgomery Crabaugh, 49

Travel between universes
Some Universal Rules, 53

Travel Works Both Ways: PCs on the road will meet many fellow wayfarers, by Paul Vernon, 105

TRAVELLER
Active Duty, 102
Antimissiles and Roundshot, 95
Asimov Cluster, 20
Black Holes!, 35
"Does Anyone Here Speak Aslan?", 91
Double-Helix Connection, 109
Dwarves in Space, 70
Filling in Skills, 55
Hexes and High Guard, 104,
High Tech and Beyond, 108
IBIS: Profit and Peril, 35
In Defense of Computers, 51
Interstellar Athletes, 88
Luna: A Traveller's Guide, 87
Make Your Own Aliens, 51
Masers & Cameras, 51
Merchants Deserve More, Too, 53
Miller Milk Bottle, 51
More Clout for Scouts, 35
New Ideas for Old Ships, 51
Of Nobles and Men, 103
"Other" Options, 35
Planet Parameters, 51
Plotting a Course for Choosy Players, 51
Preventing Complacency in TRAVELLER Gaming, 85
Relief for TRAVELLER Nobility, 73
Robots, 84
Rogues of the Galaxy, 97
Star System Generation, 27
Stellar Diocese, 101
Strategy of Survival, 18
Tesseract, 27
Translating Skitterbugging Into TRAVELLER, 59
TRAVELLER Navy Wants to Join You, 25
TRAVELLER Politician, 32
Useful Skills, 35

TRAVELLER: Star System Generation by Gary Jordan, 27

TRAVELLER adventure
Canard, 43
Exonidas Spaceport, 59

TRAVELLER Navy Wants to Join You: New service opportunities for navy characters, by Rick Stuart, 25

TRAVELLER Politician: Diplomacy and intrigue in the TRAVELLER universe, by Rick Stuart, 32

Treant
Ecology of the Treant, 79

Treasure
Charts for Determining the Location of Treasure, 19
How Many Coins in a Coffin?, 80
Mission Control, 48
Planning Creative Treasures, 19
Seventeen New Treasures, 99
Sharp System for Swords, 99
Tailor-Made Treasure, 98
Treasures Rare and Wondrous, 80
Well-equipped Victim, 105

Treasure, alternatives to
D&D Option: Orgies, Inc., 10

Treasure Trove: All-new enchanted items, 91

Treasure Trove II: A new system for swords — and more, 99

Treasures Rare and Wondrous by Ed Greenwood, 80

Tribal Society and Hierarchy on Board the Starship Warden by James M. Ward, 5

TRIBES OF CRANE
Crane is What You Make It, 46

Triceratops, 55

Trident + 1 / + 2 vs. Water Elementals by Roger Moore, 91

Triffids, 53

Trithereon, Greyhawk deity, 68

TROJAN WAR: The early years: scenarios from the designer, by Glenn Rahman, 60

Trolls in "Minarian Legends" by Glenn Rahman, 41

True Dragons: Revamping the monster from head to claw, by Lewis Pulsipher, 50

True Story of File 13: Now it can be told, by Kim Mohan, 72

Truename, magic-user spell, 68

Trumpet of Doom by Ed Greenwood, 91

Tuatha De Danaan: A revised Celtic mythos, by Robin Emrys Atkinson, 65

Tuck, Friar, character description, 55

Tundra Beast by Douglas Lent, 101

Twofold Talisman, Adventure One: Heart of Light: An RPGA tournament module for the AD&D game, by R. Moore, P. Taterczynski, D. Niles, G. Moore, 84

Twofold Talisman, Adventure Two: The Ebon Stone, AD&D tournament adventure, by R. Moore, P. Taterczynski, D. Niles, G. Moore, 85

Tybor by Jeff Brandt, 61

Tyrannosaurus Rex, 55

Ukuyatangi, 31

Ultimate NPC: Ninja — The DM's Hit Man by S. Price, 16

Ultravision, magic-user spell, 67

Ultravision, illusionist spell, 66

Umbra by Theresa Berger, 61

Uncommon Tongue: Modify modern English to add spice to your game, by Gregory Andersen, 109

Undercover Job Guide by Paul Montgomery Crabaugh, 52

Undersea Magic Items by Roger Moore, 48

Understanding Armory by Lewis Pulsipher, 53

Underwater adventuring, see Campaign design: Setting

Unearthed Arcana
Arcana Update, Part I, 103

Unfriendly Neighborhood Spider-Foes in "The MARVEL-Phile", by Jeff Grubb, 94

Unicorn
Ecology of the Unicorn, 77

Uniformity, Conformity . . . or neither? by Karl Horak, 39

Up on a Soapbox, 28,34
Adventuring with Shaky Hands, 53
Apples, Oranges, Role-Playing and Morality, 43
Art of Good Generalship, 41
Be a Creative Game-Player, 45
Dungeons Aren't Supposed to be "For Men Only", 57
Good DM Can Cure Bad Behavior, 50
In Gaming, Your Style Will Tell, 65
Individuals Do Make a Difference, 66
Level Titles Don't Do Justice, 72
Magical Systems: Rationale and Reconciliation, 37
Painted Ladies & Potted Monks, 38
Play a Villain? An Evil Idea, 57
Players Don't Need to Know All the Rules, 49
Problem of Morality in Fantasy, 39
Standardization vs. Playability, 30
To Err is Human, to Repair Divine, 52
Wargaming: A Moral Issue?, 35
Ways to Handle High-level Headaches, 45
What is Gaming's Role In Life?, 48
When Choosing a DM, Be Choosy!, 48

Up to Our Nelves in Little Blue Geeks in "The MARVEL-Phile", by Jeff Grubb, 108

Up, Up and Away: A classic game soars to new heights, by Jim Quinn, 68

Ups and Downs of Riding High by Roger Moore, 50

Urban adventures, see Campaign design: Setting

Urden
Gods of the Gnomes, 61

Urisk by Roger Moore, 94

Useful Skills by Alexander von Thorn, 35

Utgerd-Loki, Norse figure, 110

Utukku by Roger Moore, 89

Vacancy, illusionist spell, 66

Vacation Spot? Certainly Not! by Jake Jaquet, 31

Vallejo, Boris, 52

Valley Elf by Gary Gygax, 67

Valley of the Earth Mother: An AD&D adventure for 4th-6th levels, by Lise Breakey, 102

Value assessment
Assessing, Not Guessing, 104

Vampire
Good Evening: Are You Wild about Vampires?, 30
Restless Dead, 42
Varieties of Vampires, 25

Vampires in the Dungeon or, "Hey, Dave, why is this fog moving with us?", by Clayton J. Miner, 17

Vanir, family of Norse gods, 110

Varied Player Character & Non-Player Character Alignment by Gary Gygax, 9

Varieties of Vampires by R. P. Smith, 25

Vavthrudnir, Norse figure, 110

Venom, monster, table, 81

Venus
Seven Magical Planets, 38

- Venus fly-Trap, Giant** by Roger Moore, 89
- Versatile Magician:** New skills for DRAGONQUEST, by Jon Mattson, 57
- Vicarious Participant:** Take the middle ground in role-playing style, by Lewis Pulsipher, 74
- View from the Telescope Wondering Which End is Which** by Gary Gygax, 11
- Viking Campaign in the Caspian Sea** by J. E. Brunner, 24
- Vilkonnar** by Charles Carson, 34
- Villains & Variants:** Optional rules for VILLAINS & VIGILANTES gaming, by John J. Polojac, 105
- VILLAINS & VIGILANTES**
Charisma Counts!, 100
- Vilitch** by Stephen Inniss, 94
- Vision Globe** by Roger Moore, 91
- Vodyanoi, marine variety** by Mark Harcourt, 68
- Volley, magic-user spell, 68**
- Voltturnus Connection:** Building background material for the Voltturnus campaign, by Stephen Bonario, 98
- Volundr, Norse figure, 110**
- Vox-populi** in "The MARVEL-Phile", by Jeff Grubb, 203
- Vriyagga, 4**
- Vulture**
New Monsters for Low Levels, 66
- Vulturehounds** by Chris Chalmers and Dan Pollak, 37
- Vurgen** by Ed Greenwood, 89
- Wacko World:** TOP SECRET adventure, by Al Taylor, 79
- Wand of Ochalar's Eye** by Ed Greenwood, 40
- Wandering Monster** by James M. Ward, 15
- Wandering Trees:** AD&D adventure, by Michael Malone, 57
- Wanda**
Nine Wands of Wonder, 102
- Wanted: Bounty Hunters,** special section, 52
- War!** Conflicts provide characters with reasons to "live", by Lewis Pulsipher, 65
- War Machine Revisited:** Details and extra rules for D&D game battles, by Garry Spiegler, 109
- War of flowers** by William Fawcett, 25
- WAR OF THE RING Variant:** True hidden movement, by Allen Hammack, 20
- Ward, major, cloistered cleric spell, 68**
- Ward, minor, cloistered cleric spell, 68**
- Wargaming: A Moral Issue?** in "Up on a Soapbox", by Theron Kuntz, 35
- Warhorses and Barding** by Gary Gygax, 74
- Warrior Alternative:** Generating non-magical characters for the DQ game, by Craig Barrett, 86
- Was It Worth the Risk?:** A DM's guide to pickpocketing success, by Bruce Barber, 104
- Wastri, Greyhawk deity, 71**
- Water, god, 77**
- Water, Water Everywhere** by David Sweet, 41
- Water Adventures on the Starship Warden** by C. Hursh, 23
- Water elemental**
Trident +1/+2 vs. Water Elementals, 91
- Water Walking, cleric spell, 58**
- Water-horse** by Roger Moore, 48
- Wawel Castle**
Castles by Carroll II: Wawel Castle, 69
- Way We Really Play:** Development of a DM is a three-stage process, by Tom Armstrong, 106
- Ways of the Triffids** by Mark Nuiver, 53
- Ways to Handle High-level Headaches** in "Up on a Soapbox", by Lewis Pulsipher, 45
- Weapon Damage Table,** for non-fighters, 66
D&D Option: Weapon Damage, 2
These are the Breaks, 54
- Weapon Specialization** by Gary Gygax, 66
Specialization and Game Balance, 104
- Weapons**
Bows, 39
Firearms, 60
Giant-sized Weapons, 109
Keep Track of Quality, 65
New Weapons from Another "Great Mind", 64
Nomenclature of Pole Arms, 22
Or With a . . . Weird One, 61
Shield and Weapon Skills, 57
Should They Have An Edge? No, 66
Should They Have An Edge? Yes, 66
Smaller Than Man-Sized Weapons Table, 29
Weapons Wear Out, Not Skills, 65
- Improvised, tables**
Sticks, Stones, and Bones, 97
- Modem**
Second Volley, 70
Modern Monsters, 57
- Monk**
Monkish Weapons & Monk vs. Monk Combat, 18
- Ninja**
New Improved Ninja, 30
Ultimate NPC: Ninja — The DM's Hit Man, 16
- Weapons, attacking with two, table**
Be a Two-Fisted Fighter, 68
- Weapons, damage to**
When It Gets Hit, It Gets Hurt, 73
- Weapons, Witch**
Witchcraft Supplement for DUNGEONS & DRAGONS, 5
- Weapons of the Far East** by Michael Kluever, 32
- Weapons Wear Out, Not Skills:** A new proficiency system, by Christopher M. Townsend, 65
- Weather**
Role of Nature, 108
Weather in the World of Greyhawk, 68
- Weather in the Wilderness** by David Tillery, 15
- Weather in the World of Greyhawk:** A climate for realistic AD&D adventuring, by David Axler, 68
- Wee Jas, Suel god, 88**
- Weights & Measures:** Physical Appearance and Why Males are Stronger than Females, by P.M. Crabaugh, 10
- Weird, illusionist spell, 66**
- Well Spirit** by Greg Holley, 42
- Well-equipped Victim: A "treasure type" system for O-level encounters,** by Ed Greenwood, 105
- Well-Rounded Thief:** Not everyone steals for the same reasons, by John C. Bunnell, 104
- Werecreatures,** see Lycanthropy
Other Were? Right Here!, 40
- Whale, Killer** by Roger Moore, 89
- Wham's Revenge: His Games** by Bryce Knorr, 40
- What do You Get When You Cross. . . ?** by John Olson, 44
- What do You Get When You Cross a DM With a Computer?** article and program by Joseph C. Spann, 74
- What Good PCs Are Made Of:** Player characters with more substance than statistics, by Katharine Kerr, 96
- What is a Monster Worth?:** Spelling out the system for assigning x.p. values, by Roger Moore, 89
- What is Gaming's Role in Life?** in "Up on a Soapbox", by Karl Horak, 48
- What's in a Name? As Much as You Put into It** by Mark Whisler, 34
- What's That in the Water?** by Mark S. Harcourt, 68
- When Choosing a DM, Be Choosy!** in "Up on a Soapbox", by Fred Zimmerman, 48
- When History Goes Awry:** Alternate parallels in the TIME-MASTER game, by Mark Acres, 98
- When It Gets Hit, It Gets Hurt:** A system for equipment damage, by Arthur Collins, 73
- When the Rations Run Out:** Characters don't live on hit points alone, by Paul Hancock, 107
- Where the Heroes Are** in "The MARVEL-Phile", by Jeff Grubb, 98
- Where the Orcs Are:** A miniature marvel of monsters, mayhem and miscellany, by Steve Brown, 30
- Whip**
New Weapons from Another "Great Mind", 64
- Whip, magic-user spell, 67**
- Whispering Wind, illusionist spell, 66**
- Whiteout:** TOP SECRET adventure, by Merle Rasmussen, 87
- Whiz-bang Beetles** by John Hageman, 29
- Who Gets The First Swing?:** Attack priority system offers more realism, by Ronald Hall, 71
- Who Lives in That Castle?:** Building it is one thing, running it is another, by Katharine Kerr, 80
- Whole Half-Ogre:** Ideas for finishing what EGG started, by Roger Moore, 73
- Why Does It have to be Snakes?** in "The MARVEL-Phile", by Jeff Grubb, 105
- Why is the Mutant Smiling?:** New body parts in GAMMA WORLD gaming by John M. Maxstadt, 96
- Why Magic-Users and Clerics Cannot Use Swords** by Charles Sagui, 16
- Wilderness adventures,** see Campaign design: Setting
- Will Jason Destroy the Dragonship? Stay Tuned . . .** by Kenneth W. Burke, 31
- Will-o-wisp**
Ecology of the Will-o-Wisp, 99
- Wind Steed** by Ed Greenwood, 89
- Wind Thrower** by Scott Stansfield, 101
- Wind Wall, magic-user spell, 67**
- Winged Folk** by William Lenox, 51
- Wingless Wonder** by Ed Greenwood, 40
- Winnah and Still Champeen — Father Time!** Rules for aging in RINGSIDE, by Mark Schumann, 61
- Wirchler**
Creatures from Elsewhere, 47
- Wisdom**
Six Main Skills, 107
- Wish spells**
Best Wishes!, 49
Lowdown on Wishes, 19
Rare Way of Viewing the Wish, 73
- Witch**
Another Look at Witches and Witchcraft in D&D, 20
Brewing up a New NPC, 43
"Real" Witch, 43
Witchcraft Supplement for DUNGEONS & DRAGONS, 5
- Witchcraft Supplement for DUNGEONS & DRAGONS, 5**
- Without Any Weapons:** Suggested new rules for using your bare hands, by Phil Meyers, 61
- WIZARD game**
Some Spells for the Very Smart Sorcerer, 32
- Wizard Mark, magic-user spell, 67**
- Wizard Research Rules** by Charles Preston Goforth, Jr., 5
- Wizard with a Difference** by James M. Ward, 17
- Wizzo's Ring of Compulsions** by Bill Birdsall, 82
- Wolf**
Collection of Canines, 102
- Wolf in Your Paint Pot** by Marjorie Jannotta and C.A. Hundertmark, 40
- Wolf Nomads**
Protection Circles and the Like, 56
- Women Want Equality, and why not?** by Jean Wells and Kim Mohan, 39
- Work in Process: The Systematic Way** in "Fantasysmith's Notebook", 39
- Working Design for Heward's Mystical Organ** in "Bazaar of the Bizarre", by Steven Wiederholt, 29
- Working Your Way up to First Level** by Len Lakofka, 51
- World Gone Mad:** The moon of the GAMMA WORLD game, by James M. Ward, 86
- World of Difference:** The "parallel" concept expands gaming horizons, by Fraser Sherman, 105
- WORLD OF GREYHAWK**
Adding Depth to the Flanaess, 52
Appendix to "Adding Depth to the Flanaess", 52
Clerics Must Play for Skills, 89
Developments from Stonefist to South Province, 57
Great Kingdom and the Knights of Doom, 59
Greyhawk: The Shape of the World, 37
Greyhawk's World, 63,64,65,71
More "Meat" for Greyhawk, 55
Protection Circles and the Like, 56
Weather in the World of Greyhawk, 68
see also Deities and Demigods of the World of Greyhawk, Gods of the Suel Pantheon
- Worshippers of Ratar** by Eric Robinson, 51
- Worth Its Weight in Gold:** A dwarf's beard is more than hair, by John Olson, 109
- Would the Real Orc Please Step Forward?:** Dealing with the proliferation of orcsch miniatures, by L. Harrop, 25
- Wounds and Weeds:** Plants that can help keep characters alive, by Kevin J. Anderson, 82
- Wraithform, illusionist spell, 66**
- WRG Rules Modifications:** General Rules Armor & Infantry 1925-80, by Michael Reese, 32
- Wyrms, Great** by Roger Moore, 94
- Xaver** by Ed Greenwood, 94
- Xerbo, Suel god, 90**
- Xochiyaoyotl: Rules for Pre-Hispanic Mexican Warfare,** by Neal M. Dorst, 25
- Yachts and Privateers Return:** Revised statistics for STAR FRONTIERS Knight Hawks ships, by D. Niles, 88
- Yale** by Gregory Detwiler, 101
- Yefar'a Magic Mirrors** by Gerald Strathmann, 37
- Yellow dragon**
Missing Dragons, 65
- You Can Jump How Far? OK, Prove It!** by K. Thompson, 45
- You've Always Got a Chance:** Use ability scores to determine success or failure, by Katharine Kerr, 68
- Yurtus**
Gods of the Orcs, 62
- Zadron's Pouch of Wonders** by Phil Meyers & Steve Bill, 62
- Zagun, Duke of Hell, 76**
- Zegy, Greyhawk deity, 70**
- Zepar, Duke of Hell, 76**
- Zethra:** An NPC race for the STAR FRONTIERS game, by Ed Greenwood, 84
- Zombie**
Restless Dead, 42
- Zoroastrian gods**
Persian Mythos, 12
- Zuraqqor Strike Sack!** Alien starships for STAR FRONTIERS Knight Hawks gaming, by Brian Valentine, 95

RECON® is Back! And Palladium Books Has It!

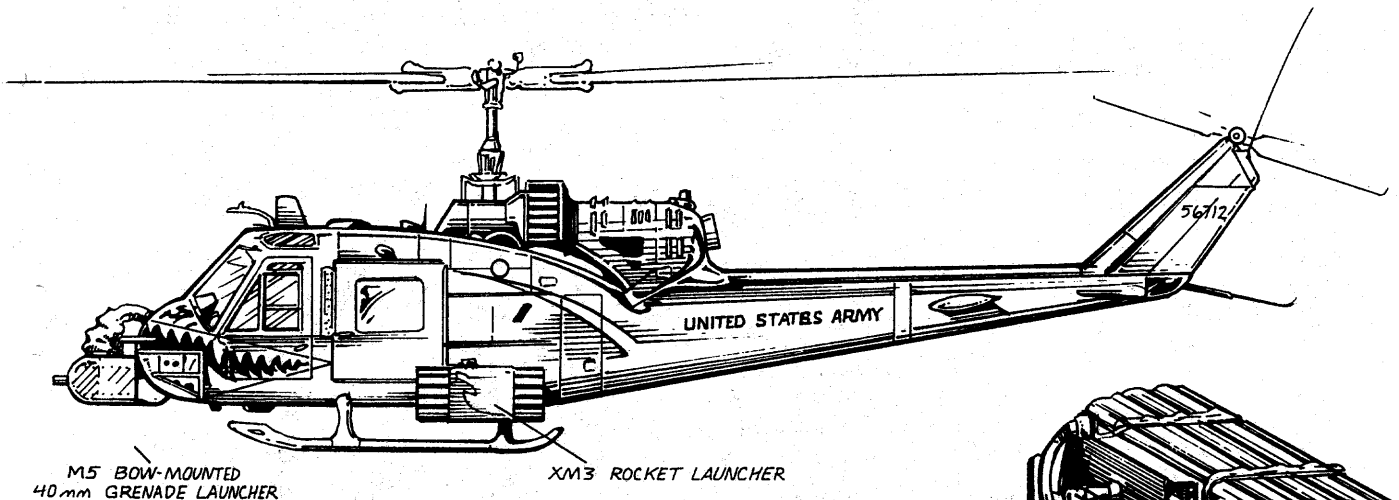

M5 BOW-MOUNTED
40mm GRENADE LAUNCHER

XM3 ROCKET LAUNCHER

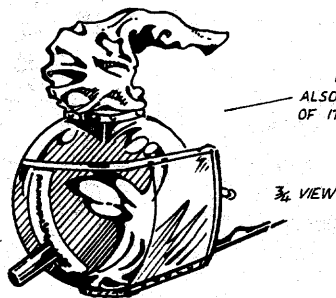

M5 40mm GRENADE LAUNCHER
ALSO CALLED "THUMPER" AS A RESULT
OF IT'S DISTINCTIVE SOUND.

3/4 VIEW

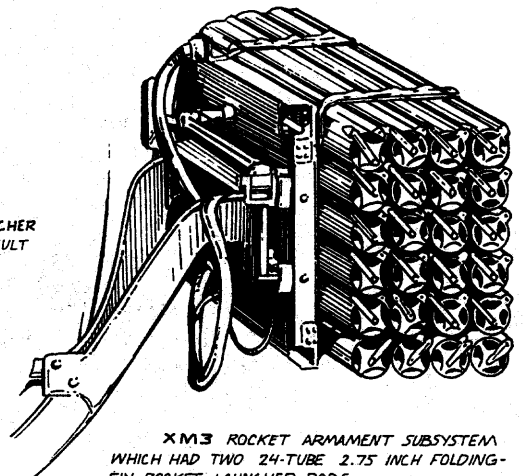

XM3 ROCKET ARMAMENT SUBSYSTEM
WHICH HAD TWO 24-TUBE 2.75 INCH FOLDING-
FIN ROCKET LAUNCHER PODS.

THE UH-1B AND UH-1C HELICOPTERS
COULD BOTH USE THIS DIRECT FIRE AREA WEAPON.

The Revised RECON®

RECON is the first and only role-playing game of modern warfare. It is a game system designed for quick playability and to simulate the kind of counterinsurgency warfare fought in the Vietnam War. Players assume characters of elite Recon teams to penetrate enemy lines on missions of rescue, intelligence, espionage and sabotage. Although the game's focus is Vietnam, players are not limited to the 1970's or Southeast Asia.

Expanded rules allow players to play contemporary mercenaries or military specialists that can span the world. An extensive hardware section includes helicopters, small arms, heavy weapons, booby traps, artillery, patrol boats, tanks and other vehicles.

Highlights Include . . .

- Revised rules for role-playing.
- The original miniature RPG rules (optional).
- Special Rules for compatibility with *Heroes Unlimited*®, *TMNT*™ and the well known Palladium game system.
- Helicopter and Modern Weapons combat rules.
- Expanded weapons section including US and Soviet weapons and vehicles. ALL illustrated.
- Booby Traps and Tunnel Rats.
- The contemporary mercenary!
- Nearly a dozen NEW adventure scenarios.
- \$14.95 (post paid)

Palladium Books®
Dept. D
5926 Lonyo
Detroit, Michigan 48210

Please allow 6 to 8 weeks for delivery.
All checks and money orders must be in US funds only.

THE PALLADIUM BOOK OF CONTEMPORARY WEAPONS contains over 300 hand-held weapons from around the world. Included are revolvers, pistols, sub-machine guns, machine guns, rifles and various attachments. Each weapon is illustrated, with many detailed cut-away diagrams, pertinent information and notes of interest.
\$5.95 (post paid).

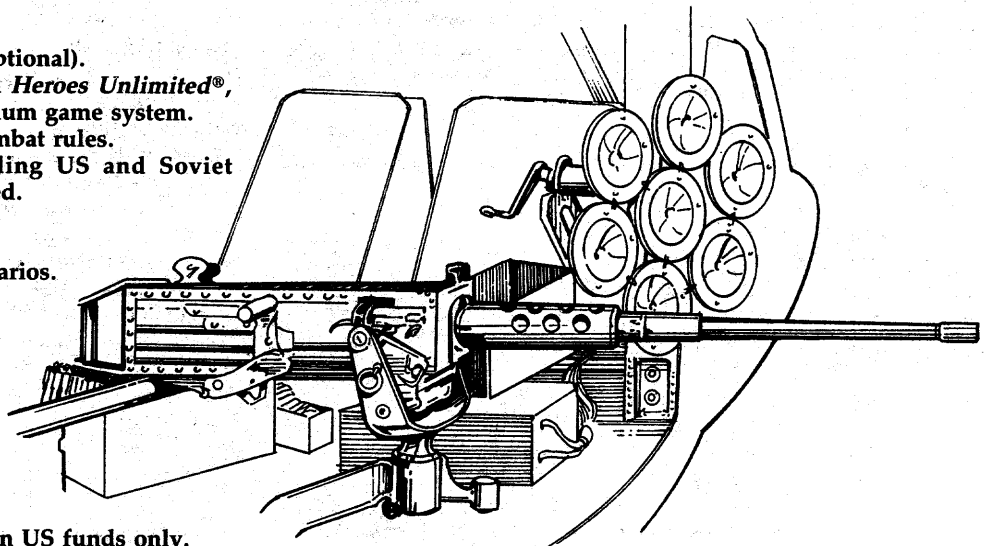

ing or swimming have an armor class of 2. They vary with size as shown below:

HD:	to ¼	½	1	2	3	4-5	6-7
DAMAGE:	Nil	1	1-2	1-3	1-4	1-6	2-8
SIZE:	S(2-3)	M(4)	L(5)	L(6)	L(7)	L(8-10)	L(11-12)

COELUROSAUR

FREQUENCY: *Common*
 NO. APPEARING: 1 or 1-20
 ARMOR CLASS: 6
 MOVE: 15" to 21"
 HIT DICE: 1 hp to 6 HD
 NO. OF ATTACKS: 3 (*claw/claw/bite*)
 DAMAGE/ATTACK: Nil to 1-4/1-4/2-8
 SPECIAL ATTACKS: *Rear claws*
 SPECIAL DEFENSES: Nil
 INTELLIGENCE: *Animal*
 SIZE: S to L (2' to 13' long)

Coelurosaurs are small to medium-sized saurischian dinosaurs from all periods of the Mesozoic. Examples include *Compsognathus* and *Ornitholestes*. These quick, lightly built bipeds may tackle anything from insects and lizards to man-sized prey, depending on their size. The typical coelurosaur is feathered, has a light wedge-shaped head and a long flexible neck, a long tail and long legs, bird-like feet, claws, and either numerous sharp teeth or a shearing beak. Coelurosaurs include the ancestors of the birds. Depending on the variety they are found singly or in small packs. Coelurosaurs vary with size as follows:

MOVE:	15"	15"	15"	18"
HIT DICE:	1 hp	¼	½	1
DAMAGE:	Nil	1	1-3	1-2/1-3 (1-3)
SIZE:	S(to 3)	S(4)	S(5)	S(6)

MOVE:	18"	21"	18"
HIT DICE:	2	3-4	5-6
DAMAGE:	1-2/1-2/1-4 (1-3/1-3)	1-3/1-3/2-5 (1-4/1-4)	1-4/1-4/2-8 (2-7/2-7)
SIZE:	M(7)	M(8-9)	M(10-13)

Attacking coelurosaurs bite, scratch with the front claws, and kick with the clawed hind feet. All front claw attacks must hit if the hind claws are to be brought into play, and damage for the kick is listed in brackets for that reason. Some coelurosaurs are given a damage range which represents all or part of the attack routine. Those with 1/4 and 1/2 HD inflict 1 and 1-3 points of damage respectively, while 1 HD coelurosaurs attack with the front claws for 1-2 points overall and with the rear claws for 1-3 points overall.

CROCODILIAN

FREQUENCY: *Common*
 NO. APPEARING: 1 or 3-24
 ARMOR CLASS: 5
 MOVE: 6"/15" (*and see below*)
 HIT DICE: 1 hp to 14 HD
 NO. OF ATTACKS: 3 (*bite*)
 DAMAGE/ATTACK: Nil to 3-36
 SPECIAL ATTACKS: *Tail sweep*
 SPECIAL DEFENSES: Nil
 INTELLIGENCE: *Animal*
 SIZE: S to L (2' to 55' long)

Crocodylians are archosaurs, and they are common in Jurassic and Cretaceous times as well as in modern settings. They include crocodiles, alligators, caimans, and gavials. The typical crocodylian is a semiaquatic predator with a sprawling gait and a skin studded

with plates of bone and horn. Some Cretaceous and Jurassic species reach astounding sizes, though modern crocodylians seldom if ever exceed 25' in length (8 HD). These predators eat anything they can catch. Though they are not particularly sociable, large numbers of crocodylians may be found together at some favored

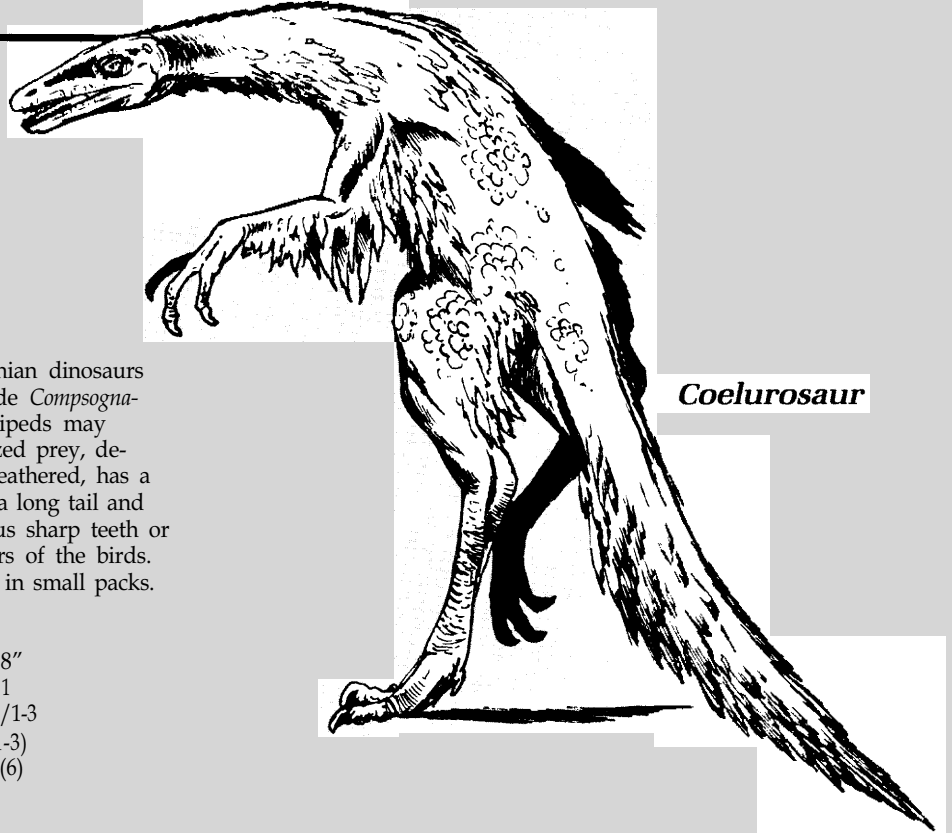

Coelurosaur

sunning spot. Those encountered in groups are of similar sizes, for obvious reasons. They vary with size as shown below:

HIT DICE:	1 hp	¼	½	1	2	3
DAMAGE:	Nil	1	1-2	1-4	2-5	2-8
SIZE:	S(to 3)	S(4)	S(5)	M(6)	M(7)	L(8-9)

HIT DICE:	4	5-6	7-8	9-10	11-12	13-14
DAMAGE:	2-12	2-16	2-20	3-24	3-30	3-36
SIZE:	L(10-11)	L(12-15)	L(16-25)	L(26-35)	L(36-45)	L(46-55)

On land (but *not* in the water) crocodylians may swing a tail against those who stray too near their hindquarters. The heavy, bony tail inflicts damage equal to the bite of a crocodylian one size class smaller (that is, a 2 HD crocodile can inflict 1-4 hit points of damage in this way). Also, crocodylians that bite for 3-24 points of damage or more can swallow man-sized prey whole. Crocodylians may be specialized in a number of different ways that affect combat ability and movement rate.

Some crocodylians are adapted to a specialized diet, either of small fishes (in which case the snout is slender and the teeth thin but sharp) or of shelled creatures such as sea turtles and mollusks (in which case the teeth are relatively blunt and are adapted to crushing). Gavials are examples of the former sort of specialization. In either case, the crocodylian's bite is less effective against other sorts of prey, and biting damage is reduced by one size class. Such specialized crocodylians may be of any size, and are found in all parts of the Mesozoic.

Though many crocodylians may venture out into the open sea, a few are heavily modified for a marine existence, with reduced body armor, paddles in place of feet, and sharklike tails. These specialized crocodylians may be adapted to fish-eating as described above. They are found only in Jurassic settings. The armor class is

reduced to 7, and the movement rate is 3"/18". Crocodylians of this sort may have up to 6 HD.

In the other direction, some crocodylians are adapted to a more terrestrial life, with legs that are longer and placed more directly beneath the body. These may be found in Jurassic and Cretaceous times. They move at 9"/12" and have no more than 7 HD. All are generalized predators.

CYNODONT

FREQUENCY: *Uncommon*
 NO. APPEARING: 1 or 2-20
 ARMOR CLASS: 7
 MOVE: 12"
 HIT DICE: 1 hp to 4 HD
 NO. OF ATTACKS: 1 (bite)
 DAMAGE/ATTACK: Nil to 2-8
 SPECIAL ATTACKS: Nil
 SPECIAL DEFENSES: Nil
 INTELLIGENCE: *Animal*
 SIZE: S to M (up to 6' long)

Cynodonts are mammal-like reptiles from Triassic times. They range from mouse-sized up to the size of a large sheep or small bear, and include both carnivores and herbivores. They have a number of mammalian traits, but their front legs retain a sprawling reptilian gait, and they have low flat lizard-like heads and thick reptilian tails. Both carnivores and herbivores have prominent canine teeth. They have nails, but not hooves or sharp claws. They may be found singly or in small groups. Though the herbivores seek to avoid encounters, the carnivores may stalk and track prey and even work in groups. Cynodonts vary as shown below:

HD:	1 hp						
DAMAGE:	Nil	1	1-2	1-4	2-5	2-7	2-8
SIZE:	S(to 2)	S(2½)	S(3)				

Herbivore cynodonts of a given size are treated as if they were one size class smaller for hit dice and damage (*i.e.*, a 6'-long herbivore has 3 HD).

DEINONYCHOSAUR

FREQUENCY: *Uncommon*
 NO. APPEARING: 1 or 1-20
 ARMOR CLASS: 6
 MOVE: 18" to 21"
 HIT DICE: 1 to 7
 NO. OF ATTACKS: 3 (claw/claw/bite)
 DAMAGE/ATTACK: up to 1-4/14/2-12
 SPECIAL ATTACKS: *Rear claws*
 SPECIAL DEFENSES: Nil
 INTELLIGENCE: *Animal*
 SIZE: S to L (6 to 13' long)

Deinonychosaurs are saurischian dinosaurs from the Cretaceous. They are close relatives of coelurosaurs but are more heav-



ily built, with a shorter neck, a larger and more powerful mouth, and a huge sharp claw on the second toe that serves as a sort of switchblade for slicing and stabbing prey. Deinonychosaurs may be found singly or in packs. All but the smallest deinonychosaurs are prone to attack man-sized creatures that they encounter. These swift predators vary with size as follows:

MOVE:	18"	18"	21"	21"	21"	21"
HD:	1	2	3	4	5	6-7
DAMAGE:	1-3/1-3	1-2/1-2/	1-3/1-3/	1-3/1-3/	1-4/1-4/	1-4/1-4/
		1-4	1-6	1-8	1-10	2-12
	(1-4)	(1-4/1-4)	(2-5/2-5)	(2-7/2-7)	(2-8/2-8)	(2-12/2-12)
SIZE:	S(6)	M(7)	M(8)	M(9)	M(10)	L(11-13)

The rear-claw attacks are listed in brackets, since they only take place if all front-claw attacks hit. The smallest sort of deinonychosaur is given a single attack representing the front claws and another representing the rear claws.

DICYNODONT

FREQUENCY: *Common*
 NO. APPEARING: 2-40
 ARMOR CLASS: 7
 MOVE: 12"
 HIT DICE: 1 hp to 6HD
 NO. OF ATTACKS: 1 (bite)
 DAMAGE/ATTACK: Nil to 2-8
 SPECIAL ATTACKS: *Trample*
 SPECIAL DEFENSES: Nil
 INTELLIGENCE: *Animal*
 SIZE: S to L (up to 9' long)

Dicynodonts are mammal-like reptiles from the Triassic. They are herbivores and vary in size from that of a woodchuck to that of a small rhinoceros. These bizarre creatures are bulky, with short, stout limbs, a thick tail, and a barrel-shaped torso. The limbs sprawl out towards the sides rather than being fully tucked under the body, as they are in mammals or dinosaurs. Dicynodonts have few teeth, or may even be toothless with the exception of a pair of tusks in the upper jaw. The teeth are largely replaced by a horny beak resembling that of a parrot or turtle. The snout is short, and the large eyes face forward. There are no hooves, only large flat claws and stubby toes.

Though small dicynodonts may use their claws to dig, and large ones may rear up and use them to pull down foliage, dicynodonts are not dextrous enough to use their claws in self-defense. Some common sorts of dicynodonts are semiaquatic herbivores, like

hippopotami. The shape of the beak varies with the diet, which may include any sort of vegetable matter. Dicynodonts vary with size as follows:

HIT DICE:	to ¼	½	1	2	3	4-6
DAMAGE:	Nil	1-2	1-4	2-5	2-8	2-12
SIZE:	S(to 2)	M(3)	M(4)	M(5)	L(6)	L(7-9)

Dicynodonts that have tusks do no more damage than those lacking them, since the primary weapon used in biting is the beak.

ICHTHYOSAUR

FREQUENCY: *Common*
 NO. APPEARING: 1-20
 ARMOR CLASS: 6
 MOVE: 0"/18" to 0"/24"
 HIT DICE: ½ to 10
 NO. OF ATTACKS: 1 (bite)
 DAMAGE/ATTACK: 1-4 to 5-20
 SPECIAL ATTACKS: Nil
 SPECIAL DEFENSES: Nil
 INTELLIGENCE: *Non-*
 SIZE: S to L (3' to 30' long)

Ichthyosaurs are seagoing reptiles found in all Mesozoic settings. An ichthyosaur might be mistaken for a shark, though it breathes air, or it might be mistaken for a dolphin, although its tail moves from side to side rather than up and down. Triassic ichthyosaurs are more obviously reptilian than their descendants. Ichthyosaurs do not lay eggs but bear their young live. The larger and more predatory ichthyosaurs won't hesitate to attack humans or man-like creatures they find in the water. Ichthyosaurs vary with size as follows:

MOVE:	18"	18"	21"	21"	24"	24"
HIT DICE:	½	1-2	3-4	5-6	7-8	9-10
DAMAGE:	1-4	2-5	2-8	3-12	4-16	5-20
SIZE:	S(3-4)	M(5-7)	L(8-10)	L(11-15)	L(16-20)	L(25-30)

In any period of the Mesozoic, there are some ichthyosaurs adapted to eating small mollusks and fish or to eating shellfish. These inflict damage as if they were one size class smaller, the smallest of them inflicting 1-3 points of damage. A few Jurassic and Cretaceous ichthyosaurs are toothless and 3" faster than normal, resembling swordfish. These do not exceed 8 HD in size. Unlike whales, ichthyosaurs cannot strike at creatures that are on the surface with their tails, since the tail does not move up and down.

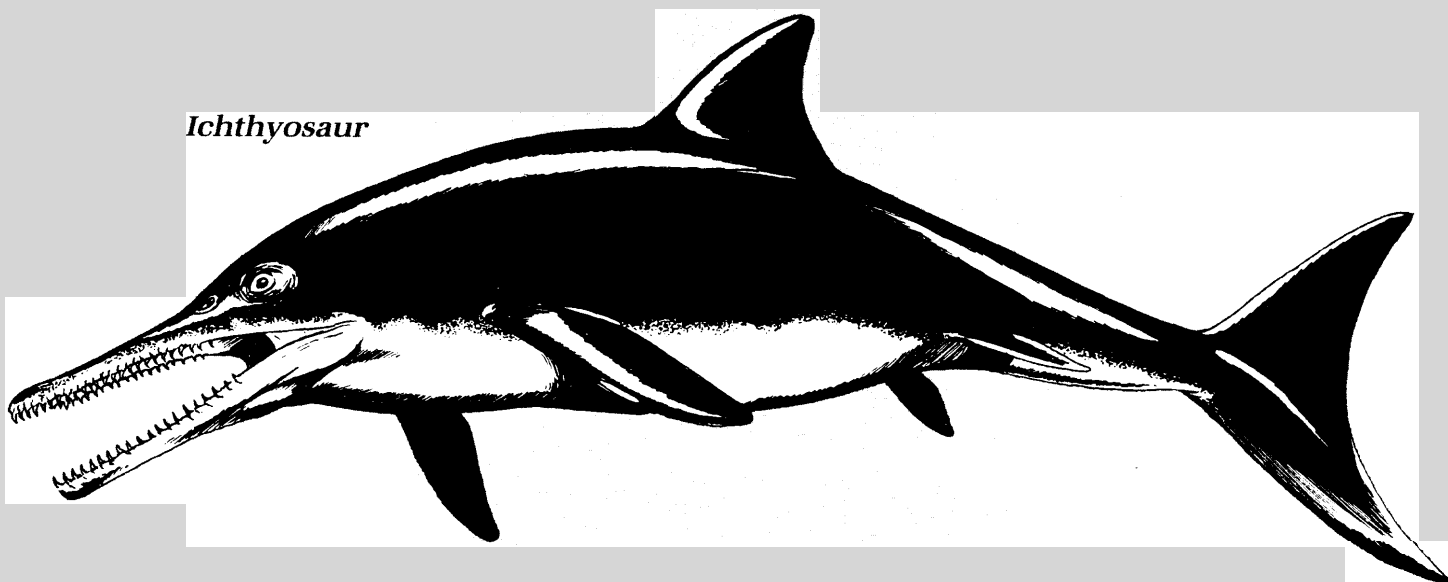

LABYRINTHODONT

FREQUENCY: *Common*

NO. APPEARING: 1 or 3-24

ARMOR CLASS: 7

MOVE: 3"/22"

HIT DICE: 1 hp to 8 HD

NO. OF ATTACKS: 3 (*bite*)

DAMAGE/ATTACK: Nil to 2-20

SPECIAL ATTACKS: *Swallow whole*

SPECIAL DEFENSES: Nil

INTELLIGENCE: *Non-*

SIZE: S to L (*up to 15' long*)

Labyrinthodonts are amphibians, and flourish in Triassic settings. They resemble crocodylians in overall form, but the typical labyrinthodont has a flattened head with upward-staring eyes, a flat broad body, and feeble legs. The mouth is huge, and full of sharp teeth. The hatchlings and very young individuals have feathery external gills, like a modern salamander larva. Labyrinthodonts include the largest amphibians ever to exist; fortunately, they never stay far from water. A labyrinthodont typically lies below the water's surface, hoping to surprise whatever edible morsel may pass by. Individuals with 7 HD or more can swallow man-sized prey whole. Labyrinthodonts vary with size as follows:

HIT DICE:	1 hp	¼	½	1	2
DAMAGE:	Nil	1	1-2	1-4	2-5
SIZE:	S(2)	S(3)	S(4)	M(5)	M(6)

HIT DICE:	3	4	5-6	7-8
DAMAGE:	2-8	2-12	2-16	2-20
SIZE:	M(7)	L(8-9)	L(10-11)	L(12-15)

MOSASAUR

Mosasaurs are huge, seagoing lizards from the Cretaceous. They are related to modern monitor lizards, but have flippers in place of feet. They can open their mouths to a huge gape, so that any adult mosasaur can swallow human-sized prey whole. Mosasaurs may be treated as non-intelligent crocodylians, some of them being adapted to shell-crushing and all of them adapted to an aquatic existence. They have from 7 to 13 HD.

NOTHOSAUR

Nothosaurs are Triassic reptiles related to plesiosaurs and pliosaurs. They are amphibious and prey on fish with the aid of a long neck and toothy jaws. The tail is relatively short, and the flippers are seal-like and bear claws, allowing movement on land. Nothosaurs may be treated as crocodylians with fish-eating adaptations and having an armor class of 7. They may have up to 4 HD and are non-intelligent.

ORNITHOMIMOSAUR

FREQUENCY: *Common*

NO. APPEARING: 1-20

ARMOR CLASS: 6

MOVE: 18" to 24"

HIT DICE: ½ to 4

NO. OF ATTACKS: 2 (*kick/peck*)

DAMAGE/ATTACK: 1-2 to 2-8/1-4

SPECIAL ATTACKS: Nil

SPECIAL DEFENSES: Nil

INTELLIGENCE: *Animal*

SIZE: S to L (*6' to 13' long*)

Ornithomimosaur is a saurischian dinosaur related to the coelurosaur, and are found in Cretaceous landscapes. They are like coelurosaur in many respects, but the head is light and toothless, the arms are long and slim and have grasping hands, and the legs are long and powerful. The eyes are huge, and the beak is ostrichlike. These dinosaurs strongly resemble flightless birds

such as the ostrich and emu, and are omnivores. An example of the type is *Struthiomimus*. Large individuals may show gustatory interest in helpless creatures of man-size or smaller. Ornithomimosaur vary with size as shown below:

MOVE:	18"	21"	21"	24"
HIT DICE:	½	1	2	3-4
DAMAGE:	1-2	1-4/1	1-6/1-2	2-8/1-4
SIZE:	S(6)	S(7-8)	M(9-10)	L(11-13)

ORMTHOPOD

FREQUENCY: *Common*

NO. APPEARING: 2-40

ARMOR CLASS: 6

MOVE: 12" to 18"

HIT DICE: 1 hp to 13 HD

NO. OF ATTACKS: 1 (*kick or bite*)

DAMAGE/ATTACK: Nil to 2-16

SPECIAL ATTACKS: *Trample*

SPECIAL DEFENSES: Nil

INTELLIGENCE: *Animal*

SIZE: S to L (*up to 45' long*)

Ornithopods are a diverse group of ornithiscian dinosaurs, They may be found in Triassic, Jurassic, and Cretaceous landscapes and may range from rabbit- or chicken-sized to mammoth-sized, although the largest forms are found in the Cretaceous. All are herbivorous and bipedal, though some may be partly omnivorous and most go down on all fours at times. Most also have a beak used to crop vegetation. The ornithopods are inoffensive and usually seek to escape if attacked, unless they are defending their young and eggs. If they retaliate, they use either a bite (some of the smaller forms do this) or a powerful and well-aimed kick. They vary with size as shown below:

MOVE:	12"	12"	15"	18"	15"	12"
HIT DICE:	to ¼	½	1	2	5-8	9-13
DAMAGE:	Nil	1-2	1-4	1-6	2-12	2-16
SIZE:	S(to 5)	M(6)	M(7-8)	M(9-10)	L(16-25)	L(26-45)

Triassic ornithopods do not exceed ¼ HD, while Jurassic ornithopods do not exceed 8 HD. The ornithopods include creatures with thick helmetlike skulls that allow them to rush heedlessly through the forest without getting brain damage from hitting trees. They also include types that have spikes on their thumbs (*Iguanodon* is an example), weapons which are not effective against smaller foes like humans. Most prominent is a Cretaceous group that includes the largest members and which is characterized by various bizarre crests and bumps on the head. These last include *Lambeosaurus* and *Anatosaurus*, the latter also being known as *Hadrosaurus* and *Trachodon*, the best known of all the so-called "duck-billed" dinosaurs).

PHYTOSAUR

Phytosaurs are archosaurs from the Triassic, rivals of the crocodylians' ancestors. They resemble crocodylians, but the nostrils are set on a volcano-shaped bump between the eyes rather than on the end of the snout. Phytosaurs may be treated as crocodylians; many are specialized fish-eaters, but they lack the other crocodylian subtypes and they never exceed 7 HD.

PLACODONT

Placodonts are Triassic reptiles that live in and near the sea and eat molluscs. Some forms are encased in bony armor and may be treated as marine chelonians. Others are more lizardlike in form, having a long broad tail and limbs that are less flipper-like. These may also be treated as chelonians, except that they are 3" faster on land, have an armor class of 5, and are 50% longer. Either form may have up to 4 HD.

PLESIOSAUR

FREQUENCY: *Common*

NO. APPEARING: 1-6

ARMOR CLASS: 7

MOVE: 3"/15"

HIT DICE: 2 to 10

NO. OF ATTACKS: 1 (*bite*)

DAMAGE/ATTACKS: 1-4 to 2-16

SPECIAL ATTACKS: *Capsize boat*

SPECIAL DEFENSES: *Nil*

INTELLIGENCE: *Non-*

SIZE: *M to L (10' to 45' long)*

Plesiosaurs are marine reptiles related to nothosaurs, yet more closely related to pliosaurs. They are common in Jurassic and Cretaceous settings. A plesiosaur resembles a marine turtle lacking a shell, and possesses a long, snakelike neck. The relatively small mouth is full of needle-sharp teeth. Plesiosaurs swim near the surface, catching any prey above or below water with sudden movements of the serpentine neck. Examples of plesiosaurs include *Elasmosaurus* and *Plesiosaurus*. They vary with size as shown below:

HIT DICE:	2-3	4-5	6-7	8-9	10
DAMAGE:	1-4	2-5	2-8	2-12	2-16
SIZE:	M(7-10)	L(11-15)	L(16-25)	L(26-40)	L(41-50)

PLIOSAUR

Pliosaurs are marine reptiles related to plesiosaurs. Like plesiosaurs, they row about the Jurassic and Cretaceous oceans with their paddlelike fins. Unlike plesiosaurs, they have short necks and long jaws. Though their mode of locomotion differs, they may be treated as crocodilians of 5 HD or more, all adapted to aquatic conditions and some adapted to shell-crushing. They are non-intelligent.

PROSAUROPOD

FREQUENCY: *Common*

NO. APPEARING: 1-20

ARMOR CLASS: 6

MOVE: 12" to 15"

HIT DICE: ¼ to 11

NO. OF ATTACKS: 2 (*kick/kick*)

DAMAGE/ATTACK: *Nil to 2-12/2-12*

SPECIAL ATTACKS: *Trample, tail-swipe*

SPECIAL DEFENSES: *Nil*

INTELLIGENCE: *Non-*

SIZE: *S to L (5' to 40' long)*

Prosauro pods are saurischian dinosaurs from the Triassic, and resemble sauropods. They may be smaller than a man or as large as an elephant. A prosauropod has a long neck topped with a small head, a corpulent body, and a long tail. The hind legs are larger and stronger than the front legs, and prosauropods are apt to move bipedally when they are in a hurry. There is a long claw on the thumb of each forefoot. Prosauro pods are primarily herbivorous, though they snap up very small animals they encounter. They flee if attacked. Prosauro pods vary with size as shown below:

MOVE:	12"	12"	15"	15"	15"	12"	12"
HD:	¼	½	1	2	3-4	5-8	9-11
DAMAGE:	<i>Nil</i>	1/1	1-2/1-2	1-4/1-4	1-6/1-6	2-8/2-8	2-12/2-12
SIZE:	S(to 5)	M(6-7)	M(8-9)	M(10-12)	L(13-15)	L(16-25)	L(26-40)

A prosauropod may swing its tail at attackers who approach from the rear or the rear flank. The damage from a sweep of the tail is equal to that at from a single kick.

PROTEROSUCHIAN, PSEUDOSUCHIAN

Proterosuchians and pseudosuchians are archosaurs from the Triassic. They are crocodilelike in appearance, although they have a more erect gait and occasionally rise up on their hind legs. They are treated as crocodilians of terrestrial form with a 12" move on land. They have up to 6 HD.

PTEROSAUR

FREQUENCY: *Common*

NO. APPEARING: 1-20

ARMOR CLASS: 10

MOVE: 3"/24"

HIT DICE: 1 *hp* to 4 *HD*

NO. OF ATTACKS: 1 (*bite*)

DAMAGE/ATTACK: *Nil to 2-12*

SPECIAL ATTACKS: *Dive*

SPECIAL DEFENSES: *Nil*

INTELLIGENCE: *Animal*

SIZE: *S to M (up to 40' wingspan)*

Pterosaurs are flying archosaurs, the first group to take to the air (the second set were the ancestors of the birds). They may be found in Jurassic and Cretaceous settings, filling many of the roles that birds do in modern settings. Pterosaurs have membranous wings, like those of bats, though the outer parts of the wing are supported by a single finger along its leading edge rather than by a spray of fingers. Also like bats, pterosaurs have a hairy covering, though pterosaurs have insulation on the wing as well as the body, so that the wings don't appear bare. Like birds, pterosaurs have good vision and are most active by day. Like albatrosses or swifts, pterosaurs spend most of their time in the air, since they are clumsy afoot and may have difficulty taking off again. Since their wing membranes are quite vulnerable to injury, they won't usually risk an encounter that might end in a grounding, which would almost certainly be fatal. If disturbed near their nesting grounds, though, they dive at the intruders, gaining surprise on a 1-4, and retreat to the skies after a single strike. Pterosaurs vary with size as follows:

HIT DICE:	1 <i>hp</i>	¼	½	1
DAMAGE:	<i>Nil</i>	1	1-2	1-4
SIZE:	S(to 10)	S(11-15)	S(16-20)	S(21-25)

HIT DICE:	2	3	4
DAMAGE:	1-6	2-8	2-12
SIZE:	M(26-30)	M(31-35)	M(36-40)

A pterosaur's size, based upon wingspan, is deceptive; even those with huge spans are not very massive. Pterosaurs can carry up to half their own weight over very short distances. The 4 ND pterosaurs may carry 700 gp, 3 HD ones may carry 500 gp, 2 HD ones may carry 300 gp, 1 HD individuals may carry 200 gp, and 1/2 HD pterosaurs may carry 100 gp weight. If a carried item is near the weight limit or if it struggles, the pterosaur may drop it and then return to see the result. Pterosaurs with but a single hit point are class B fliers; those with 1 HD or less are class C fliers, and those with 2 HD or more are class D fliers. There are two subtypes of pterosaur:

Rhamphorhynchoids are Jurassic pterosaurs, all being small and having no more than a single hit point. They have long tails and short necks, and their mouths are full of needle-shaped teeth. They prey on small animals and fish.

Pterodactyloids are from the Jurassic and Cretaceous, though those with more than ¼ HD are unique to Cretaceous settings. They include large scavengers. A pterosaur has a long neck and practically no tail, and the teeth are reduced or absent, being replaced by a beak. *Pteranodon*, a fish-eating variety, is an example of one of the larger forms.

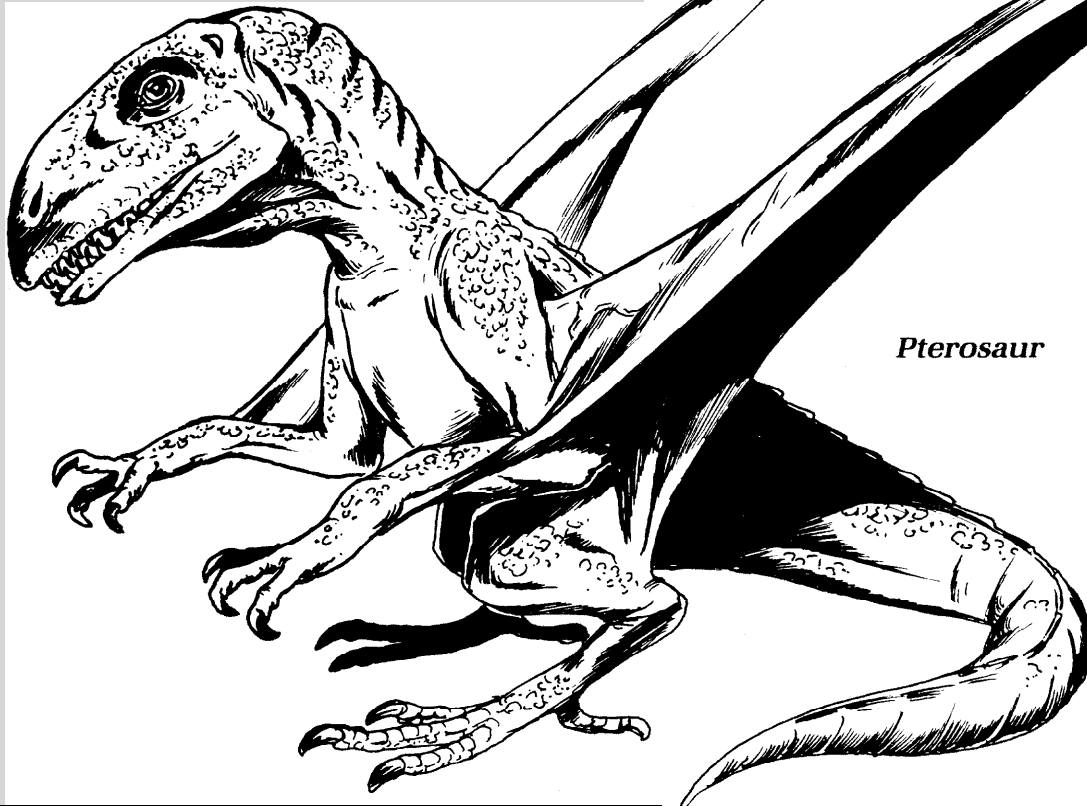

Pterosaur

RHYNCHOSAUR

FREQUENCY: *Common*
 NO. APPEARING: 1-20
 ARMOR CLASS: 6
 MOVE: 9"
 HIT DICE: 1 hp to 2 HD
 NO. OF ATTACKS: 1 (*bite*)
 DAMAGE/ATTACK: Nil to 1-4
 SPECIAL ATTACKS: Nil
 SPECIAL DEFENSES: Nil
 INTELLIGENCE: *Non-*
 SIZE: *S to M (up to 3' long)*

Rhynchosaurs are lizardlike reptiles from the Triassic, where they may be extremely abundant in places. They are herbivores, some up to the size of a pig. With its large body, sprawling legs, and beaked head, a rhynchosaur may be envisioned as a large, barrel-shaped iguana with a parrotlike beak. Rhynchosaurs eat seeds and fruits, but they bite if molested. They vary with size as follows:

HIT DICE:	to ¼	½	1	2
DAMAGE:	Nil	1	1-2	1-4
SIZE:	S(2-3)	M(4)	M(5)	M(6)

SAUROPOD

FREQUENCY: *Common*
 NO. APPEARING: 1-20
 ARMOR CLASS: 6
 MOVE: 9" to 12"
 HIT DICE: 9 to 36
 NO. OF ATTACKS: 2 (*kick/kick*)
 DAMAGE/ATTACK: 2-12/1-12 to 3-36/3-36
 SPECIAL ATTACKS: *Trample, tail-swipe*
 SPECIAL DEFENSES: Nil
 INTELLIGENCE: *Non-*
 SIZE: *L (30' to 40' long)*

Sauropods are saurischian dinosaurs from the Jurassic, resembling prosauropods. They include the largest of the dinosaurs. Unlike prosauropods, they never move about on their hind legs, though they may rear up to reach high vegetation. The smallest sauropods are comparable to elephants in size, while the largest rival whales. They are exclusively herbivorous. The construction of their feet is such that they do not bog down in the mud despite their size, and they are comfortable in and around water. Though they are peaceful enough under ordinary circumstances, they do protect their young, and they can inflict terrible damage if they are molested. Sauropods vary with size as follows:

MOVE:	12"	12"	9"	9"	9"	9"
HD:	9-12	13-16	17-20	21-24	25-30	31-36
DAMAGE:	2-12/2-12	2-16/2-16	2-20/2-20	3-24/3-24	3-30/3-30	3-36/3-36
SIZE:	L(30-45)	L(46-55)	L(56-65)	L(66-75)	L(76-90)	L(91-105)

A sauropod defends itself with its massive front feet. As with prosauropods, the thumb supports an elongated nail. A sauropod can also swing its tail at enemies who are near its hindquarters, inflicting damage equal to a kick. The lengths given above are for a "normal" sauropod. In actuality, there is considerable variation in build. Sauropods that do not conform to the general type are as follows:

Brachiosaurids are the giants of the group, having no fewer than 13 HD. The largest varieties, found in Jurassic settings, may reach the 31 to 36 HD range — the only sauropods known to do so. *Brachiosaurids* are also unusual in that their front legs are longer than their hind legs, rather than the other way around, and in that the tail is short and thick. A *brachiosaurid* with any given number of hit dice has the length of a sauropod one size-class smaller (*i.e.*, a 21 HD individual has a length of 90' or less).

Diplodocids include such beasts as *Apatosaurus* (a.k.a. *Brontosaurus*) and *Diplodocus*. They are from the Jurassic and the Cretaceous, and the Jurassic forms include the longest sauropods. Because they are so long and thin, *diplodocids* have the length of a sauropod one size class larger. They may have up to 26 HD.

Titanosaurids are 9-22 HD sauropods of normal build, found in the Cretaceous. They differ from other sauropods in having bony plates and nodules in their skin, which confer an armor class of 5.

SCOLIDOSAUR

Scolidosaurs are Jurassic ornithischian dinosaurs. They resemble ankylosaurs, although they are not as heavily armored. They may be treated as nodosaurid ankylosaurs (*q.v.*) with an armor class of 4 and up to 4 HD.

STEGOSAUR

FREQUENCY: *Uncommon*

NO. APPEARING: 1-8

ARMOR CLASS: 6

MOVE: 12"

HIT DICE: 1 to 10

NO. OF ATTACKS: 1 (*tail*)

DAMAGE/ATTACK: 1-4 to 2-20

SPECIAL ATTACKS: *Trample*

SPECIAL DEFENSES: *Nil*

INTELLIGENCE: *Non-*

SIZE: *M to L (10' to 30' long)*

Stegosaurus are ornithischian dinosaurs from the Jurassic. They have long hind legs and short front legs, and are longer and thinner than their ankylosaur relatives. A double row of spines or plates runs along the back, and though this provides some protection against carnosaur bites (AC 4), it does not otherwise affect armor class. A stegosaur has a small head, weak small teeth, and a beak. If molested, it lashes out with its spiked tail. Stegosaurus vary with size as follows:

HIT DICE:	1	2	3	4-6	7-9	10
DAMAGE:	1-4	1-6	2-8	2-12	2-16	2-20
SIZE:	M(8-9)	L(10-11)	L(12-13)	L(14-20)	L(21-25)	L(26-30)

Meeting Mesozoic monsters

Of the various ways in which Mesozoic animals may be introduced into a campaign, the "lost world" theme is perhaps the best known, since it has become something of a tradition in fantasy: an island, valley, or (as in Arthur Conan Doyle's original) a plateau cut off from the rest of the world. This is a useful approach, if a somewhat limited one. It has the advantage that the Mesozoic animals can be used as a unit, as a single episode in the careers of the PC adventurers.

The DM designing such a scenario must decide whether the lost world contains animals from just one period of the Mesozoic or from more than one, and whether or not there are any non-Mesozoic inhabitants such as cavemen, mammoths, modern creatures, or fantastic creatures. It is also advisable to apply some thought to the question of how big the area is. This is not a trivial question for those who worry about plausibility, since it takes a large chunk of real estate to support a few sauropods, and a large number of sauropods to support a breeding population of carnosaurs. The greater the number and variety of animals in the lost world, the bigger it must be. It may be best to think in terms of thousands of square miles in setting up the enclave.

Finally, some thought might be devoted to the question of how all of these animals are penned in and how other animals are excluded. Most large animals can be kept in by steep terrain, and even small ones can be stopped by extremely hostile land such as sand desert or permanent ice. The designer may also wish to

experiment with the idea of poisonous cloud-banks, which aren't out of the question in a fantasy world. Whatever barrier is used, though, it's hard to see how it could hold back a pterosaur, which can sail along for days at high altitude with hardly a flap of the wings. The large aquatic animals so conveniently placed around an undiscovered island are similarly hard to explain, though deep waters and cold currents might just possibly do the trick. The whole lost-world concept seems to be based on the questionable idea that Mesozoic animals couldn't survive in a world full of modern fauna, and that they therefore need protection.

Another approach, one implied in the encounter tables at the back of *Monster Manual II*, is that Mesozoic animals might be a normal part of the campaign world wherever the weather is warm enough. Certainly this doesn't have any of the problems of a lost-world scenario, since there's plenty of room and no need to worry about barriers. Most of the Mesozoic fauna retain an exotic flavor with such an arrangement, since most campaigns are set in a cool temperate area, and most Mesozoic animals won't stray that far north. They wouldn't be all that far away, though. If Mesozoic fauna were loose in the real modern world, they would probably thrive as far north as the Gulf Coast states or California.

In any case, the larger and more spectacular Mesozoic animals are likely to be restricted to wilderness areas, just like the larger members of the modern fauna, since civilizations are hard on large animals. Small and medium-sized Mesozoic animals might well turn out to be significant even in the more heavily settled areas, though. In warm and mild areas, the presence of such animals as large sauropods could help explain how dragons get by when the supply of human meat runs low.

An idea worth exploring is that the dinosaurs might visit the adventurers, rather than the other way around. Mesozoic creatures were often spectacularly successful in their own times, and they might be all too successful in modern settings as well. Imagine the damage a few carnosaurs might do to the local livestock, or the havoc a small herd of sauropods could wreak in local forests! (The wreckage of torn turf and toppled trees that elephants leave behind only begins to approximate what a hungry sauropod might do.) Smaller dinosaurs and their Mesozoic allies and rivals might be an even bigger problem, since they could be harder to find and catch. Imagine ornithomimosaur gobbling down the year's crop of grain, or deinonychosaurs ambushing travelers in the woods. Some of these animals could prove to be prolific, aggravating the problem. As for the aquatic animals, imagine their effect on local shipping: what sailor would go out on waters where a snaky head might pop up and snatch him off the deck at any moment? In cool climates, cowardly player characters might simply wait for winter (though in the meantime locals might be eaten, or might starve to death), but this won't work in tropical or subtropical areas, and in any case some Mesozoic animals might possess the instincts for seasonal migration, in which case they could be back next year!

These scenarios allow for a number of possibilities, including freelance bounty-hunting and trouble-shooting on the part of player characters or organized crusades to eliminate the monsters. They work best of all, of course, if the player characters have acquired holdings or responsibilities in an area. An invasion of dinosaurs and their contemporaries could be as costly and troublesome as an invasion from the neighboring kingdoms. In fact, the two might be combined if the neighbors detect a weakness caused by the first invasion, or if they blame player characters for the appearance of the monsters.

Now that time elementals and a Plane of Time have been introduced into the AD&D game (in *Monster Manual II*), there is yet another opportunity for Mesozoic madness: time travel. (This might explain the abovementioned invasion of Mesozoic monsters — a hostile time elemental? an uncontrolled time-gate?) While short-range travel would have to be ruled out because of the confusion caused by time paradoxes and the like, long-range journeys needn't present such problems. Player characters might visit the distant past through the agency of cursed scrolls, deities (hostile, friendly, or just bored), *gate* effects (one-way or otherwise), the functioning or malfunctioning of new magical items, or the machinations of artifacts and relics. (Perhaps some of the "relics"

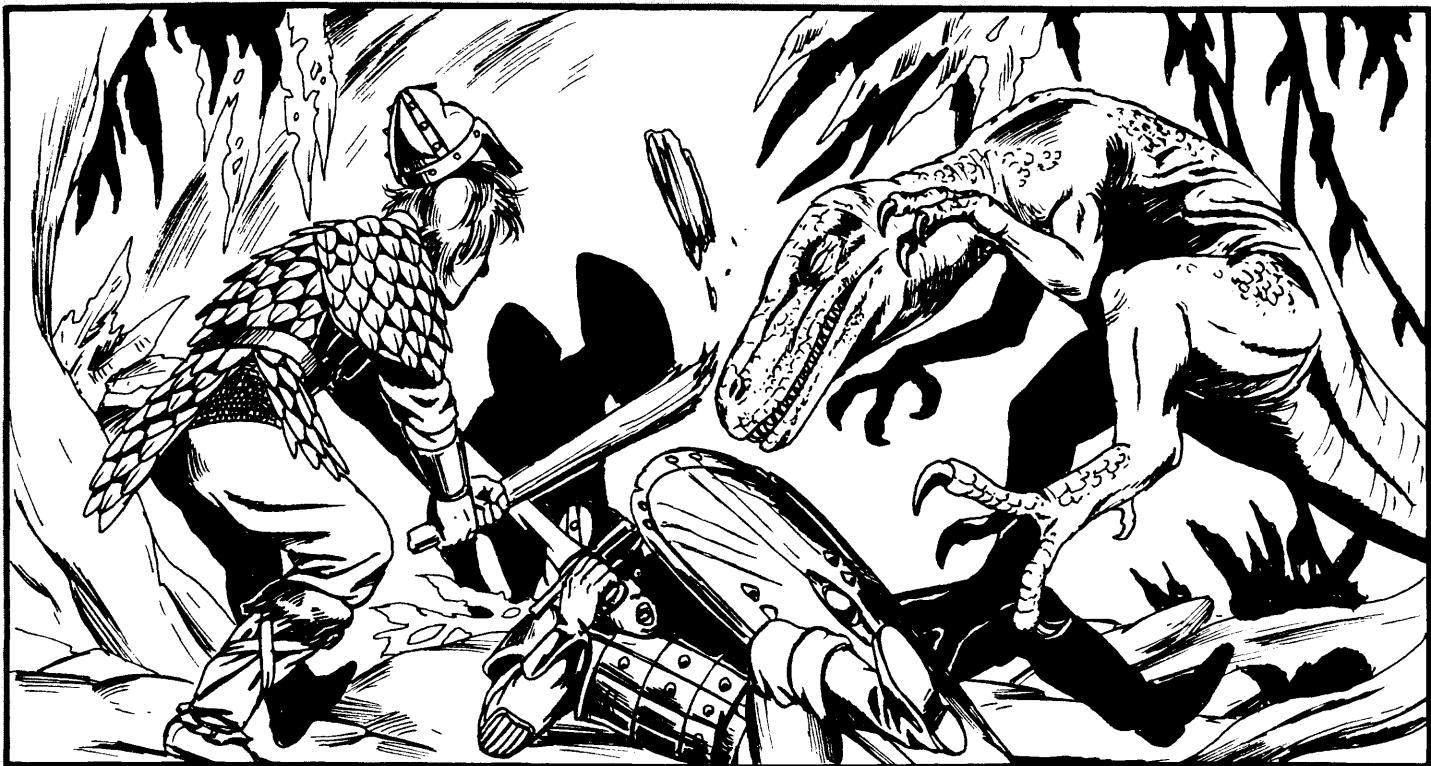

in a campaign world were crafted so long ago that they add a whole new meaning to the word "artifact"; perhaps they'd like to go "home.") However they get there, player characters in Mesozoic settings must face an alien and sometimes hostile landscape in addition to the animals that inhabit it. They may also be worried about how they might return home as something other than fossils, though this varies according to the circumstances of their arrival. In many ways, the challenge is comparable to that of visiting another plane, an alternate world, or an alien planet. Clerics are cut off from their not-yet-in-existence deities (since AD&D game deities are merely immortal, not eternal), thieves are out of contact with their familiar cities and victims, fighters are far from the nearest weaponsmiths, and magic-users are cut off from the magic that permeates most campaign worlds. Finding food, shelter, and material components for spells is a whole new exercise.

In designing and refereeing adventures in "unearthly," environments such as this, it is well for the DM to have relevant information ready at hand, concerning the various things adventurers might notice about their prehistoric surroundings. This sort of local color can be applied to any of the above concepts, though it works best with the time-travel scenario.

Period pieces

Information on the climate, terrain, plant life, and minor animal life not only adds color to the adventure, but also indicates some of the challenges that player characters must face if their stay in a Mesozoic setting is prolonged — most particularly the problems of supply and shelter. The surroundings, at the same time alien and hauntingly familiar, may prove as difficult as the large animals themselves.

The creator of a Mesozoic setting should remember that each period of the Mesozoic not only spans a great deal of time, but also that each era within the Mesozoic offers its own new world. The Mesozoic had its deserts, deep seas, high mountains, arid plains, and chilly northern forests, as well as the better known rain forests, swamps, and warm shallow seas. Only a polar icecap is implausible, and even that wouldn't be entirely out of place in some Triassic settings.

That said, it is noteworthy that Mesozoic climates were milder than those of earlier and later eras. Tropical and subtropical con-

ditions extended far north and south of the equator, and warm temperate climates sometimes reached to the poles. Adventurers might be treated to the sight of the midnight sun in a land of palm trees and tropical reefs, or the winter darkness in a forest far north of the arctic circle. For most of the Mesozoic, the oceans reached farther onto the continents, leaving shallow seas over the low-lying parts and giving most places a mild coastal climate. This doesn't rule out deserts, though. Some of the most notable deserts of today extend right down to the water. Rain was seasonal in many Mesozoic climates, so droughts and forest fires are not at all out of the question. Imagine trying to evade a forest fire and herds of fleeing dinosaurs at the same time!

The plant life and minor animal life are sketched in below for each Mesozoic period. It would be impossible to cover everything, so the emphasis is on what might be immediately relevant or noticeable to AD&D game adventurers. The information has been simplified and padded out, since accurate data on plants and small animals is hard to find. Their fossil records are poor, and such data isn't often featured in popular books. The DM can decide on the basis of the material here what components are available for spells (especially druidic ones) and which of the giant animals in the *Monster Manual* might be added to the scene if a larger cast of creatures is required.

Triassic: The earliest part of the Mesozoic is the most alien to the eyes of player characters. Conifers are numerous, and yew trees are present, too, along with cycads (which look like palm trees but bear cones), tree ferns, and common ferns. Other common plants are less familiar: trees with plum-like fruit and fan-shaped leaves, plants that look like cycads but bear flowers on their trunks, and plants that look like ferns but bear seeds and grow to tree size. In swampy areas, there are giant lycopods, which look like a cross between a palm tree and a giant moss. Large horsetails replace the reeds and rushes of modern times. None of the modern flowering plants — hardwood trees, wild flowers, or grasses — are present.

There are animals that look like lizards, rodents, and salamanders, but the "rodents" are mammal-like reptiles, the "lizards" are unrelated to modern ones, and the "salamanders" are small labyrinthodonts. No true frogs and toads exist. The turtles bear teeth and won't be able to pull into their shells, and no sea turtles and tortoises exist. Among insects, the ants, bees, wasps, butterflies,

bloodsucking lice (unless a half-orc unwittingly imports some), and a great many sorts of flies are absent. The rest of the arthropod world is out in force, however, so spells like *creeping doom* and *summon insects* should work quite well. Missing from the land are birds, snakes, land snails, and slugs.

Many seashore animals look familiar, but there are no crabs scuttling about. (Incidentally, trilobites are from a much earlier time and are not present.) The coral reefs look familiar, even if some of their inhabitants are strange. Sea lilies may be found which are dozens of feet long from "stem" to "petals." Ammonoids and nautiloids, looking like octopi in spiral shells, are numerous, and other cephalopods exist that resemble squids, though true squids and octopi are absent.

Many fishes resemble modern types, but most are covered in thick scales like those of a modern gar. Numerous lungfishes and coelacanths are found in fair numbers almost everywhere, as are eel-like freshwater and marine sharks, but no skates or rays are present.

Jurassic: In many ways, Jurassic scenes are like Triassic ones. The large lycopods and seed ferns are gone, but little else in the plant world is changed. Turtles are fully toothless, the rodentlike animals may be called true mammals, and the lizards and salamanders are like modern ones. True frogs and toads hop about the landscape. To the hordes of insects are added ants and wasps. Birds, hardly to be distinguished from small coelurosaurs, are

found in and around the trees. There are numerous small rhamphorhynchoid pterosaurs. Slugs and land snails have put in an appearance. There are crabs at the seaside (looking somewhat lobsterlike), and squids have joined the other cephalopods. There are fewer lungfish and coelacanths, but more sharks.

Cretaceous: The Cretaceous plant world is very different from that of the rest of the Mesozoic. Conifers continue and the rest of the Jurassic plants are present, but the flowering plants have arrived: magnolia, walnut, poplar, and willow, beech and maple, and many more, along with palms, ivy and poison ivy, grapevines, elderberries, water lilies, cattails, and others. The druid's oak, mistletoe, and holly are present, though not exactly the sorts one is used to seeing. Only the grasses are missing.

Small land animals bear a familiar aspect. Modern types of lizards may be recognized, and the small mammals include opossums and shrewlike forms. The only insects missing are horseflies, deerflies, and other types that attack large mammals. There are birds in abundance: many modern types, as well as other less familiar birds that bear teeth. Still missing are songbirds (including ravens and crows), hummingbirds, and modern birds of prey. There are snakes, but only large constrictors and small burrowers without poison. The reefs include large bivalve molluscs the size and shape of drinking horns. Octopi join the other cephalopods.

The older, heavy-scaled fishes have been partly replaced by modern types, including recognizable relatives of the tarpon, eel,

TABLE A1: Triassic Encounters (animals by terrain and frequency on that terrain)

Mountains

Common
Pseudosuchian
Uncommon
Cynodont, carnivore
Cynodont, herbivore
Dicynodont
Prosauropod
Rare
Aetosaur
Carnosaur ¹
Proterosuchian
Rhynchosaur

Hills

Common
Dicynodont
Prosauropod
Pseudosuchian
Rhynchosaur
Uncommon
Aetosaur
Carnosaur ¹
Cynodont, carnivore
Cynodont, herbivore
Proterosuchian

Forest

Common
Aetosaur
Dicynodont
Prosauropod
Pseudosuchian
Rhynchosaur
Uncommon
Carnosaur ¹
Cynodont, carnivore
Cynodont, herbivore
Proterosuchian

Desert

Common
Pseudosuchian
Uncommon
Cynodont, carnivore
Cynodont, herbivore
Prosauropod
Rare
Carnosaur ¹
Dicynodont
Proterosuchian
Rhynchosaur
Very Rare
Aetosaur

Fresh water, surface

Common
Labyrinthodont
Nothosaur
Uncommon
Dicynodont ¹
Phytosaur
Rare
Carnosaur ¹
Proterosuchian
Shark ⁴

Fresh water, depths

Common
Labyrinthodont
Uncommon
Nothosaur
Rare
Dicynodont ¹
Phytosaur
Shark ⁴
Very Rare
Carnosaur ¹

Swamps

Common
Aetosaur
Dicynodont
Phytosaur
Prosauropod
Pseudosuchian
Rhynchosaur
Uncommon
Carnosaur ¹
Cynodont, carnivore
Cynodont, herbivore
Labyrinthodont
Proterosuchian

Plains

Common
Dicynodont
Prosauropod
Pseudosuchian
Uncommon
Carnosaur ¹
Cynodont, carnivore
Cynodont, herbivore
Proterosuchian
Rhynchosaur
Rare
Aetosaur

Salt water, surface

Common
Ichthyosaur
Nothosaur
Placodont
Uncommon
Portuguese man-o-war
Shark
Rare
"Barracuda" ³

Salt water, depths
Common
Ichthyosaur
Placodont
Uncommon
"Barracuda" ³
Nothosaur
Shark

1: Triassic carnosaurs do not exceed 10 HD.
2: Semiaquatic form.
3: Similar but unrelated form, 3" slower.
4: Triassic fresh-water sharks do not exceed 4 HD.

herring, and cod. Still missing are the spiny-finned fishes and their relatives such as swordfish, perch, flounder, and sea horses. Gar and sturgeon may be recognized. The coelacanths and lungfish are rare. Sharks flourish, and the rays have appeared.

Tables A1, AZ, and A3 provide lists of the larger fauna for each Mesozoic period in the style of the *Monster Manual II* encounter tables. Animals with less than 1/2 HD are not included, since they are not usually significant to adventurers. If needed, lists can be compiled from the animals described above and from the smaller representatives listed in the "A" tables, and the DM should allow two encounter checks for every one with larger animals. Otherwise, the lesser fauna can just be used to set the scene. In creating encounter tables from these lists, the DM should choose a particular subtype and hit die size for each entry (for example "ankylosaur, nodosaurid, 5 HD" or "ornithopod, 12 HD"). This saves time when the animals are encountered randomly. Some terrain types have no listing for rare or very rare animals. These slots can be filled with the less-common members of the larger groupings. For instance, large carnosaurs are less common than smaller ones.

Additional encounters

There are a number of other creatures from the *Monster Manual* and related works that wouldn't be out of place in Mesozoic settings. The most appropriate of these are merely larger versions of animal types present in the Mesozoic. Giant eels, giant octopi, giant sea turtles, giant "rats" (to represent the small mammals), giant constricting snakes, giant lampreys, and a number of others could merely be larger versions of animals found in one or another of the periods of the Mesozoic. The feel of a particular Mesozoic period can still be retained even if more fantastic creatures such as giant insects, crabs, spiders, and centipedes are added

(each in the appropriate period). Giant frogs and toads and other magically supported or altered creatures might also be added. However, the Mesozoic has an abundance of animal types already. The more interesting additions are the intelligent creatures.

The field of candidates for intelligent Mesozoic races is large, but it can be narrowed considerably if all those that partake heavily of human characteristics, or are mammals, or are common and widespread in the campaign world are eliminated from the onset. After all, the Mesozoic is billed as the Age of Reptiles, and there are plenty of the more manlike species at home in the adventurers' native settings. Of the remaining creatures, there are two main groups, though they overlap a bit: those that can be represented as relatives of real Mesozoic animals, and those that could be immigrants from other times, assuming the possibility of some means of time travel.

Of the first group, lizard men are the prime candidates. With some minor modifications in their depiction, they could be passed off as the descendants of semiaquatic coelurosaurs. With a world to themselves, the lizard men might be more diverse. There could be exceptional individuals with magic-user abilities. There could be cities, towns, and nations. There could be groups of different alignments. There might even be different species — lighter, swifter types, for instance, farther inland, or aquatic varieties farther out at sea. In part, the diversity depends on how many other intelligent species exist with which the lizard men share their world. For instance, troglodytes might be included and given the same sort of ancestry. The kuo-toa or the locathah might be depicted as bizarre descendants of labyrinthodonts or lobe-finned fishes, though there is more science fantasy and less science fiction involved here. Perhaps the kuo-toa would still be surface dwellers in a Mesozoic world. Further toward the fantastic, the ixitxachtli might be included in Cretaceous settings, since they seem to be a sort of ray.

Other than the natives, there might be a number of other intelli-

TABLE A2: Jurassic Encounters (animals by terrain and frequency on that terrain)

<p>Mountains <i>Common</i> Coelurosaur <i>Uncommon</i> Ornithopod ¹ <i>Rare</i> Carnosaur Scelidosaur Stegosaur</p>	<p>Fresh water, surface <i>Common</i> Crocodilian <i>Uncommon</i> Plesiosaur Sauropod <i>Rare</i> Carnosaur</p>	<p>Plains <i>Common</i> Coelurosaur Ornithopod ¹ <i>Uncommon</i> Carnosaur Scelidosaur Stegosaur <i>Rare</i> Sauropod</p>	<p>Salt water, surface <i>Common</i> Crocodilian, marine Ichthyosaur Plesiosaur Shark <i>Uncommon</i> Crocodilian Pliosaur Portuguese man-o-war <i>Rare</i> "Barracuda" ² Shark, giant</p>
<p>Hills <i>Common</i> Coelurosaur Ornithopod ¹ <i>Uncommon</i> Carnosaur Sauropod Scelidosaur Stegosaur</p>	<p>Fresh water, depths <i>Common</i> Crocodilian <i>Uncommon</i> Plesiosaur <i>Rare</i> Sauropod <i>Very Rare</i> Carnosaur</p>	<p>Desert <i>Common</i> Coelurosaur <i>Uncommon</i> Ornithopod ¹ <i>Rare</i> Carnosaur Scelidosaur Stegosaur</p>	<p>Salt water, depths <i>Common</i> Crocodilian, marine Ichthyosaur Shark <i>Uncommon</i> "Barracuda" ² Plesiosaur Pliosaur <i>Rare</i> Crocodilian Shark, giant</p>
<p>Forest <i>Common</i> Coelurosaur Ornithopod ¹ Sauropod <i>Uncommon</i> Carnosaur Scelidosaur Stegosaur</p>	<p>Swamps <i>Common</i> Coelurosaur Crocodilian Ornithopod, Sauropod <i>Uncommon</i> Carnosaur Scelidosaur Stegosaur</p>		

1: Jurassic ornithopods do not exceed 8 HD.

2: Similar but unrelated form, 3" slower.

gent non-mammalian creatures that have somehow arrived and flourished in a Mesozoic setting: dragons, bullywugs, gripli, krakens, ophidians, and yuan-ti, to name only a few. Since they have access to the Plane of Time via *probability travel*, the illithids (mind flayers) might also be included in a Mesozoic setting, particularly if there are intelligent races on which they may prey. In such a setting, they might be merely nocturnal rather than subterranean in nature.

Suppose that after they have traveled back in time to the Mesozoic, some particularly adventurous player characters choose to explore the Inner or Outer Planes. It is a fair bet they won't find genies, demons, and devils of manlike form in the distant past, not if the DM is an imaginative one. Perhaps the residents of the other planes are modeled on whatever intelligent creature dominates the Mesozoic Prime Material Plane (as per the nonhuman deities of *Legends & Lore*), or perhaps the Inner or Outer Planes are uninhabited or even nonexistent. If player characters spend a significant amount of time exploring the Mesozoic, the DM will have to give at least some attention to the problem. For instance, what happens when elementals are summoned, or when various spells that contrast or conjure up creatures from the Outer Planes are used? The safest course is to rule that these spells simply fail,

but brave and imaginative DMs may wish to try out a few interesting ideas of their own.

Mesozoic melee

Even if Mesozoic animals are granted the greater intelligence and speed suggested here, smaller animals are added to the mix, and they are placed in a larger context with environmental challenges, and even if a few appropriate intelligent creatures are included in the scenario, there is still a problem that crops up sooner or later: big-game hunting. While it may be exciting the first time some dull-witted fighter slugs it out toe-to-toe with a triceratops, it can hardly be interesting the second time. The sheer number of hit points and melee rounds involved make repeated combats with large creatures tedious, since there aren't many possibilities in the situation. The largest creatures to walk the earth, even the imaginary earth the player characters live on, become boring. Some further considerations may prevent this, however, if the DM takes them into account.

One problem with Mesozoic animals in the game, or for that matter with any animals in the AD&D game, is that the DM may

TABLE A3: Cretaceous Encounters (animals by terrain and frequency on that terrain)

Mountains

Common
Coelurosaur
Uncommon
Ceratopsian
Ornithomimosaur
Ornithopod
Pterosaur
Snake, constrictor
Rare
Ankylosaur
Carnosaur
Deinonychosaur

Hills

Common
Ceratopsian
Coelurosaur
Ornithomimosaur
Ornithopod
Uncommon
Ankylosaur
Carnosaur
Deinonychosaur
Pterosaur
Snake, constrictor
Rare
Sauropod ¹

Forest

Common
Ceratopsian
Coelurosaur
Ornithomimosaur
Ornithopod
Uncommon
Ankylosaur
Carnosaur
Deinonychosaur
Sauropod ¹
Snake, constrictor
Rare
Crocodilian, terrestrial
Pterosaur

Desert

Common
Coelurosaur
Ornithomimosaur
Pterosaur
Uncommon
Ceratopsian
Deinonychosaur
Ornithopod
Rare
Ankylosaur
Carnosaur

Fresh water, surface

Common
Crocodilian
Pterosaur
Uncommon
Ornithopod ¹
Plesiosaur
Rare
Carnosaur
Crocodilian, terrestrial
Sauropod ¹
Snake, constrictor

Fresh water, depths

Common
Crocodilian
Uncommon
Plesiosaur
Rare
Ornithopod ⁴
Snake, constrictor
Very Rare
Carnosaur
Crocodilian, terrestrial
Sauropod ¹

Swamps

Common
Coelurosaur
Crocodilian
Ornithopod
Pterosaur
Uncommon
Ankylosaur
Carnosaur
Crocodilian, terrestrial
Sauropod ¹
Snake, constrictor
Rare
Deinonychosaur
Ornithomimosaur

Plains

Common
Ceratopsian
Coelurosaur
Ornithomimosaur
Ornithopod
Pterosaur
Uncommon
Ankylosaur
Carnosaur
Deinonychosaur
Rare
Crocodilian, terrestrial
Very Rare
Sauropod ¹

Salt water, surface

Common
Chelonian, marine
Ichthyosaur
Mosasaur
Plesiosaur
Pterosaur
Shark
Uncommon
Crocodilian
Pliosaur
Portuguese man-o-war
"Swordfish" ²
Rare
"Barracuda" ²
Ray, manta ²
Shark, giant

Salt water, depths

Common
Chelonian, marine
Ichthyosaur
Mosasaur
Ray, sting
Shark
Uncommon
"Barracuda" ²
Plesiosaur
Pliosaur
Ray, manta ³
"Swordfish" ²
Rare
Crocodilian
Shark, giant

1: Cretaceous sauropods do not exceed 24 HD.

2: Similar but unrelated form, 3" slower.

3: Harmless non-fantastic form (plankton eater); no effective bite.

4: Semiaquatic "duck-billed" dinosaur.

forget to take the surroundings into account. These beasts are well adapted to their native haunts, and have a "home advantage." What is more, interactions with other animals may turn out to be important. Large sauropods are a good example of this. On the face of it, they shouldn't be any great challenge to intelligent players, since the characters are more mobile and have distance weapons (if nothing else, they can simply shoot their victim to death if they have enough arrows). Sauropods are most likely to be found in marshes and forests, though — hardly the best places for a running horse or even for a running man. While the sauropods won't be greatly inconvenienced (they belong there), humans or horses are slowed by undergrowth (which the sauropods ignore), fallen trees (which the sauropods step over), and boggy ground (which sauropods simply wade through). Though the rulebooks provide no specific guidelines on this point, it is clear enough that the sauropods have the advantage of mobility, not the player characters. If they decide to trample their small foes, they can probably do it. If they choose to flee, they can probably get away. Sauropods might be seen, heard, and even smelled from a considerable distance, but it could prove impossible to keep up with them. Then, too, any herd of sauropods is likely to have a few predators and scavengers in attendance, waiting for an easy meal. The weakened or preoccupied hunter might be the victim of carnosaurs or coelurosaurs.

The sauropods are just one example. Similar considerations apply in other environments, particularly aquatic ones. Player characters may find that it is unwise to attack a large animal from a small boat (that is, if they want to keep the boat), and that melee almost invariably attracts predators. Even fairly small aquatic animals might simply hold swimmers under until the swimmers drown. Such considerations may force players to give more thought to the actions and strategies of the characters they play.

Another aspect of large animals is that they have a unique place in the game system from the DM's point of view. The more hit dice a creature has, the more special abilities it tends to have, so that monsters with a lot of hit points tend to have intelligence and talents that make them more dangerous than they would other-

wise be. Large animals are an exception to the general rule; despite their impressive hit-point totals and the large amounts of damage they can inflict, they have few special abilities and limited intelligence. The incautious DM may be fooled into thinking that they may be compared to demons or dragons that are in the same hit-dice range, with the result that Mesozoic monsters enter the campaign too late, when the characters have already reached high experience levels.

A large animal presents little challenge to characters of high level, not so much because these characters have good armor-class ratings and high hit-point totals, but because they tend to be highly mobile and have a large number of powerful distance weapons. It is better to introduce these animals when the characters are at a lower level of experience, when there is less temptation to depend on sheer power and more incentive to use clever strategies. Large animals are a good introduction to the idea of using brain rather than brawn, using indirect and perhaps nonlethal approaches rather than frontal and violent attacks. The rewards are high, in the form of experience points gained, and the price of foolishness is also high, since a direct confrontation is likely to result in the destruction of the player characters.

Sources

Numerous books have been written on the dinosaurs and their contemporaries. The DM in search of material that might be used to color descriptions may find an abundance of information at any library. Of the various popular books on Mesozoic life, John C. McLoughlin's *Archosauria* and *Synapsida* both provide colorful commentary and an abundance of excellent illustrations. David Lambert's *A Field Guide to Dinosaurs* is also recommended. In looking through a collection of books on prehistoric animals, it is well to remember that personal bias can play a big part in popular presentations. It is also a good idea to take a look at the copyright dates on some of the more tattered tomes — the book itself may be a fossil.



TABLE B: "Dinosaurs" from the Monster Manual volumes redescribed

Species	New classification	HD*	Species	New classification	HD*
Anatosaurus	ornithopod	10-11	Megalosaurus	carnosaur	13-14
Ankisaurus	prosauropod	½	Monoclonius	ceratopsian (horned)	8
Ankylosaurus	ankylosaur, ankylosaurid	11	Mosasaurus	mosasaur	12
Antrodemus	carnosaur	14-16	Nothosaurus	nothosaur	2-4
Apatosaurus	sauropod, diplodocid	21-22	Ornitholestes	coelurosaur	5
Archelon	chelonian, marine	7	Paleoscincus	ankylosaur, nodosaurid	9
Brachiosaurus	sauropod, brachiosaurid	31-36	Pentaceratops	ceratopsian (horned)	9
Camarasaurus	sauropod	19-20	Phororhacos	Not Mesozoic; flightless bird from Miocene	
Camptosaurus	ornithopod	to 7	Plateosaurus	proquauropod	8
Ceratopsaurus	carnosaur	8-10	Plesiosaurus	plesiosaur	4-5
Cetiosaurus	sauropod	13-18	Podokesaurus	coelurosaur	5
Compsognathus	coelurosaur	1 hp	Pteranodon	pterosaur, pterodactyloid	2
Dacentrurus	stegosaur	5	Pterosaur, giant	pterosaur, pterodactyloid	4
Deinonychus	deinonychosaur	3-7	Stegosaurus	stegosaur	10
Dilophosaurus	carnosaur	10	Struthiomimus	ornithomimosaur	3
Dimetrodon	Not Mesozoic; synapsid reptile from Permian		Styracosaurus	ceratopsian (horned)	8
Dinichthys	Not Mesozoic; placoderm fish from Devonian		Xmystropeus	Lizardlike animal from Triassic with long tail, long stiff neck, and small head: 13' in all, with a 2'-long body; no effective attack.	
Diplodocus	sauropod, diplodocid	23-24	Tennodontosaurus	ichthyosaur	10
Elasmosaurus	plesiosaur	10	Teratosaurus	carnosaur	10
Euparkeria	pseudosuchian	1 hp	Triceratops	ceratopsian (horned)	12
Gorgosaurus	carnosaur, tyrannosaurid	15-16	Tyrannosaurus	carnosaur, tyrannosaurid	18
Iguanodon	ornithopod	10			
Kentrosaurus	stegosaur	5			
Lambeosaurus	ornithopod	12-13			
Mamenchisaurus	sauropod, diplodocid	21-22			
Massopondylus	prosauropod	3-4			

* — Hit dice may differ from official number either because of this new system or because of newly discovered information.

Bubba the Barbarian says:

"DON'T EAT QUICHE"

"Don't eat quiche. Don't sit with your back to a dragon's lair. Chew lots of garlic — it keeps the elves and vampires away. Never date anyone with fangs longer than yours. Watch out for storm giants named Billy-Bob and Muffy. And if you want adventure, look for it in a dungeon, 'cause that's what adventure is all about — DUNGEON™ Adventures.

"And stop taking baths. That's for sissies."



Dungeon™

ADVENTURES FOR TSR™ ROLE-PLAYING GAMES

See the subscription card in this issue and order a year's worth of DUNGEON™ Adventures today, for the best in AD&D® and D&D® gaming entertainment.



TSR, Inc.

Twilight: 2000—Back in the USA!

First stop: Texas, in Red Star/Lone Star

Red Star/Lone Star pits a group of American soldiers against the different factions of troops and marauders vying for control of the Texas gulf coast and its wealth. The entire coast is covered in detail, including maps, troop strengths (for the American, Soviet, and Mexican forces still functioning), and plans for Gulfwind Forty, an offshore oil platform which may figure prominently in the adventure. Jammed with excitement and intrigue, *Red Star/Lone Star* welcomes our boys back from Europe. \$7.00.

Future stops . . .

Armies of the Night: A guided tour of the Big Apple. The player characters are charged with keeping some sort of order while street gangs fight it out and certain unscrupulous individuals seek out a fortune in gold bars.

Allegheny Uprising: When the Civilian US government stuffed the ballot box in Pennsylvania, the eastern counties declared their independence. But can they make it stick against hired mercenaries and returning army veterans?

Air Lords of the Ozarks: Before the war, commercial dirigibles had just come into their own as efficient freight transporters. Several of the few surviving airships are now used by the storm troopers of New America to impose their despotic rule on the hill country of the Ozarks.

Red Star/Lone Star is now available. The others will be appearing this fall, along with more modules set around the world!

Prices subject to change without prior notice.
Available at local hobby stores or direct from GDW.
Add \$1.00 for shipping and handling.
Send for a free catalog.

Twilight: 2000

GDW Game
Designers'
Workshop

PO Box 1646, Bloomington, IL 61702-1646

FIRE SALE!



Subscribe to

Dragon[®]

Magazine

while it's hot!

No, we're not going out of business — in fact, we're more fired up than ever! DRAGON Magazine is 10 years old this summer, and we've decided to celebrate by giving you a special opportunity to subscribe to the world's biggest and best role-playing game magazine. If you order a subscription — a new one or a renewal — between now and Aug. 31, you can get 12 issues of DRAGON Magazine for only \$24 instead of the regular price of \$30. That figures out to just \$2.00 per issue — a bargain you can't afford to pass up!

Use the reply card in this issue of DRAGON Magazine to order, or simply send your name and address along with payment in advance to TSR, Inc., P.O. Box 72089, Chicago IL 60690. Just be sure your order is postmarked by Aug. 31, and then settle back and let us do the rest!

Dire Invasion

Rom™ and the Spaceknights™ of Galador

by William Tracy

In another area of the Milky Way galaxy, far from Earth, flourished the civilization of Galador. The inhabitants of Galador were a highly advanced and peaceful race, and spread their philosophy across the stars. About 200 Terran years ago, the Galadorian exploration fleet entered an area known as the Dark Nebula and encountered the nebula's inhabitants, an alien race known as the Dire Wraiths™. These hostile shape-changers were experts in technology and sorcery. Summoning a birdlike monster known as Deathwing, the Dire Wraiths ambushed and destroyed the Galadorian space fleet.

The Prime Director of Galador, after receiving the last message from the doomed fleet, asked for volunteers from the populace to participate in a special program. The volunteers' bodies would be placed in suspended animation while their brains and nervous systems would be grafted into a special suit of cybernetic armor. The mission of these volunteers, who were known as Spaceknights, was to defeat the Dire Wraiths before their evil could reach other civilizations. Rom™ was the first volunteer for this program.

The Spaceknights were provided with special weapons, space flight capability, and superhuman strength. Though the Spaceknights destroyed most of the Dire Wraith space fleet and the demon Deathwing, many Dire Wraiths escaped, and their forts were believed to exist in other sections of the galaxy. The location of the Wraith homeworld was unknown as well. The Spaceknights

swore to battle the Dire Wraiths anywhere in the galaxy until the last of them had been hurled into Limbo with the neutralizer guns of the Galadorians.

A special Galadorian space probe eventually detected Wraith activity on Earth and relayed the information back to Galador. Rom volunteered to go to Earth, and upon his arrival he learned that Earth's society had already been infiltrated by the shape-changing aliens. The Wraiths usually took over a world by killing and assuming the identities of their victims, who were often important members of society.

At first, Rom was hunted by the legal authorities for murder. When Rom used his neutralizer on the disguised Dire Wraiths to cast them into Limbo, it looked like he was killing human beings. Eventually, the population of Clairton, West Virginia, discovered that Rom's story was true after being shown the powers of the Dire Wraiths. Clairton then aided Rom whenever possible, even protecting him from federal authorities after he used his neutralizer on some high officials of the Pentagon who were actually Dire Wraiths.

While in Clairton, Rom met and fell in love with a human woman named Brandy Clark™, who in turn fell in love with the dedicated alien. Rom was soon joined by a fellow Spaceknight, his Galadorian fiance Starshine™. When Starshine was killed by the Dire Wraiths and removed from her armor, Brandy Clark was placed in Starshine's armor by magical means as part of a scheme to destroy Rom. The plot failed and Brandy fought alongside Rom in Starshine armor. Much later, Brandy was removed from the



armor by the evil sorcery of Hybrid", the offspring of a human and a Dire Wraith.

When Rom was away from Clairton, it was protected by Brock Jones, the Torpedo™. Brock had come upon the original builder and wearer of the Torpedo armor suit, who had been critically injured in an unplanned battle with Daredevil™. The man told Brock that his name was Michael Stivak. Before Michael died, he told Brock about his suit and background. Michael was a Yugoslavian scientist who had been brought to America by his uncle, Senator Eugene Stivak. The Senator hired Michael to build and design a battle-suit for the American government, but Michael later found out that his uncle was working for some unknown and unfriendly organization.

Michael was trying to destroy the plans for the battle-suit when he had his accidental fight with Daredevil. Before Michael died, he made Brock promise to destroy the plans; Brock donned the suit and quickly did so. For the next few months, he acted as a part-time super hero, fighting a group called the Rocketeers™ several times. These men, hired by Senator Stivak, wore weaker prototypes of Torpedo's battle-suit.

The Rocketeers soon discovered Brock's secret identity, forcing him to move his family to another city, which happened to be Clairton. There he met Rom and became his ally. Later they found that Torpedo's battle-suit had actually been financed by the Dire Wraiths, who had been looking for a new weapon to use against Rom. Rom made Torpedo a special pair of goggles that enabled him to see Dire Wraiths, no matter what form they were in.

Meanwhile, a shake-up in the Dire Wraith chain of command had occurred. So far, the Dire Wraiths on Earth had consisted of the males, who were experts in technology. The female Wraiths were experts in sorcery and were the leaders of the race. The females decided that the males weren't doing a very good job of world-conquering, so they took over all Earth operations and killed all the males present.

Then, while Rom was away from Clairton, the female Wraiths took over the town while magically clouding Torpedo's mind so that he wouldn't notice anything. Eventually, everybody in Clairton was dead and had been replaced by Wraiths. Torpedo died fighting Wraiths in his burning house. The Torpedo battle-suit was apparently destroyed in the fire. Rom and Starshine II swore to avenge the people of Clairton and the courageous Torpedo.

By this time, the government had discovered that Rom was not a homicidal alien, but a benevolent being trying to save Earth from the Dire Wraiths. The government placed S.H.I.E.L.D.™ and its psionic division in control of Wraith-destroying missions and enlisted the help of various super heroes, including the X-Men™ and Alpha Flight™. Eventually, a special branch of S.H.I.E.L.D. known as the Wraith-Hunter Rangers was formed to deal with the problem.

Rom soon gained two new allies: Rick Jones™ and a little girl named Cindy Adams™. Rick Jones, who has been involved with many super heroes, became one of Rom's closest friends and allies even though he was in love with Brandy Clark. Rick discovered that he was dying of an incurable form of cancer, the same cancer that killed Captain Marvel™ some time before. Cindy Adams was a normal child until she was attacked by a Dire Wraith. The Wraith was killed just as it had begun to absorb her memories. Because of this, a part of the Wraith's consciousness was lodged in her mind, and at times Cindy could guess what the Wraiths were planning.

Unfortunately, a government agent named Peter Gyrich™ was assigned to the Dire Wraith branch. Gyrich, who had worked with super heroes before, was apparently paranoid when it came to super beings. He caused many problems for Rom and his newest ally, the mutant known as Forge™.

After fighting a losing battle on Earth, the Wraiths decided on one final plan. They prepared to use their magic to teleport their homeworld to Earth's solar system, destroying the Earth and putting the homeworld in the Earth's orbit. Luckily, Forge was able to build a larger prototype of Rom's neutralizer and have it placed in orbit around the Earth. Powered by Rom's neutralizer, it was aimed and fired at the Wraithworld, destroying the planet

and a great portion of the Wraiths' power, since it was the source of their sorcerous energy. With the power of the Wraiths broken, mopping-up operations finished off the remainder of the alien invaders.

In time, Rom left Earth to return to Galador, accompanied by several of his fellow Spaceknights. They discovered that Galador, which had been transferred to a new galaxy by Galactus™, had been ravaged by second-generation Spaceknights who were to have defended the world. All the Galadorians were soon slain by the rouge Spaceknights, who were in turn defeated by Rom and his allies. Brandy Clark, who had been sent to Galador by the Beyonder™, helped the remaining Spaceknights find the means to turn Rom back into his original human form. His mission completed, Rom retired with Brandy to spend their days on Galador and rebuild its civilization, protected by the surviving Spaceknights.

Several characters described in the Rom saga have already appeared in modules and supplements published by TSR, Inc. The Torpedo armor was described in MHAC-8, Weapons Locker, and Peter Gyrich and Forge were described in MHAC-5, *Project: Widesawake*™. S.H.I.E.L.D. appeared in MHAC-2, *Avengers™ Assembled!*, as did Rick Jones™. The other important heroes and villains of this saga are given below.

ROM™

Spaceknight of Galador (Inactive)

Fighting: INCREDIBLE (40)
Agility: EXCELLENT (20)
Strength: INCREDIBLE (40)
Endurance: MONSTROUS (75)
Reason: EXCELLENT (20)
Intuition: EXCELLENT (20)
Psyche: GOOD (10)

Health: 175

Karma: 50

Resources: Amazing (government backed)

Popularity: 20

Talents: Rom had no special talents.

Known Powers:

FLIGHT. Rom's armor was provided with twin rocket pods (electrically powered, low-density plasma engines) which enabled him to fly at Unearthly speed in the vacuum of space or at Monstrous speeds in an atmosphere. Rom also possessed special sensors that enable him to locate space warps with Monstrous ability and range, allowing "shortcuts" through space with Class 1000 range.

BODY ARMOR. Rom's suit of armor provided him with Incredible protection against all physical, radiation, heat-based, and cold-based attacks. He could survive in deep space indefinitely.

REGENERATION. Rom's armor had built-in microfactories able to repair damaged circuitry, providing him with Good regeneration.

Equipment Weapons: The following equipment was kept in a fold in hyperspace and could be mentally summoned and used in one turn.

ENERGY ANALYZER. This item's main function was to emit ultra-high frequency waves that scanned a being's molecular structure. The waves caused certain rare earth elements in the Dire Wraiths' bodies to emit special radio waves which were visible to Rom's visor sensors, enabling him to see the Dire Wraiths as they truly were, no matter what form they took. The analyzer could also scan other items and beings, and inform Rom of the object's or being's power potential. The analyzer could trace the energy trails of powerful beings or objects. The analyzer had no attack abilities, though it bathed the subject in a red energy field that could frighten the victim.

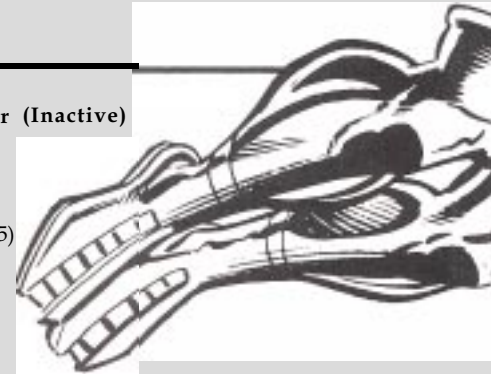

All Marvel characters, MARVEL SUPER HEROES, and the distinctive likenesses thereof are trademarks of the Marvel Comics Group. Copyright ©1986 Marvel Comics Group, a division of Cadence Industries Corporation. All Rights Reserved. ROM is a trademark of Parker Brothers. Copyright ©1986 Parker Brothers.

STARSHINE™ I and II Landra (I) and Brandy Clark (II) Spaceknights of Galador

	I (Deceased)	II (Inactive)
Fighting:	REMARKABLE (30)	EXCELLENT (20)
Agility:	INCREDIBLE (40)	INCREDIBLE (40)
Strength:	INCREDIBLE (40)	INCREDIBLE (40)
Endurance:	MONSTROUS (75)	MONSTROUS (75)
Reason:	EXCELLENT (20)	TYPICAL (6)
Intuition:	GOOD (10)	TYPICAL (6)
Psyche:	GOOD (10)	TYPICAL (6)
Health:	185	175
Karma:	40	18
Resources:	AMAZING	AMAZING
Popularity:	10	10

Talents: Starshine (II or I) had no special talents.

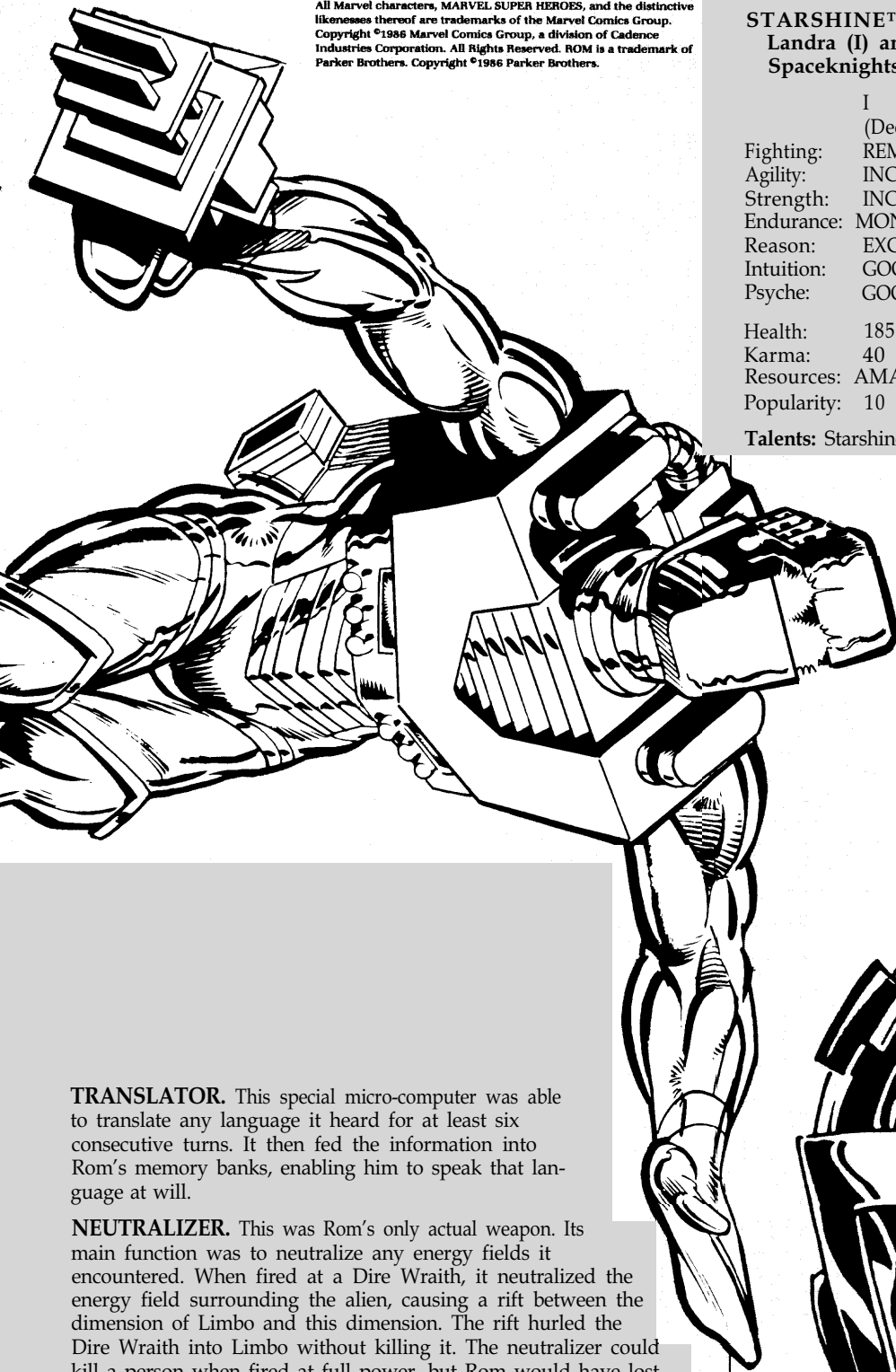

TRANSLATOR. This special micro-computer was able to translate any language it heard for at least six consecutive turns. It then fed the information into Rom's memory banks, enabling him to speak that language at will.

NEUTRALIZER. This was Rom's only actual weapon. Its main function was to neutralize any energy fields it encountered. When fired at a Dire Wraith, it neutralized the energy field surrounding the alien, causing a rift between the dimension of Limbo and this dimension. The rift hurled the Dire Wraith into Limbo without killing it. The neutralizer could kill a person when fired at full power, but Rom would have lost all Karma points for killing anyone, even Dire Wraiths. Rom could automatically determine the power level of the weapon. Dire Wraiths taken to Limbo were unable to escape from it.

At its lowest setting, the neutralizer could neutralize radiation poisoning in organic beings. At its highest setting, it neutralized the life-force of a being, killing it instantly. A human could not be transported into Limbo because a human could not survive the trip or a direct hit from the neutralizer set at that power level.

Anyone trying to use the neutralizer, except Rom, took Monstrous damage; no damage was taken by just touching the weapon. Brandy Clark, in human form, once used the neutralizer without dying, though she was badly injured. At the time, she was psionically protected by Charles Xavier™.

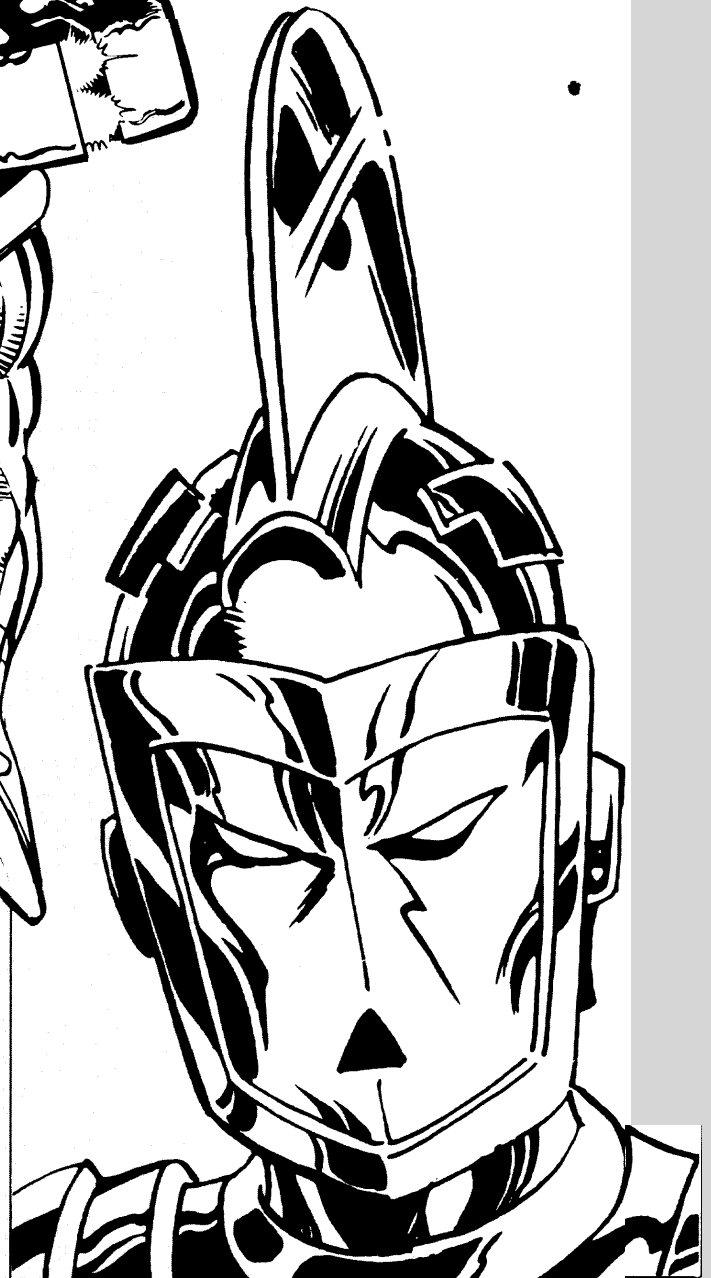

Known Powers:

FLIGHT. Starshine, like Rom, had Unearthly flight ability.

BODY ARMOR. Starshine had Rom's Incredible body armor and could survive in deep space indefinitely.

REGENERATION. Starshine had Good regeneration abilities.

LIGHT POWERS. Starshine used a form of energy known as the "living light" of Galador. She could project beams of this light from her eyes, doing concussive damage of up to Unearthly levels, and she can control the power level to do less damage as well. She was also able to use this power to emit normal light.

CINDY ADAMS™

Orphan

Fighting: POOR (4)
Agility: TYPICAL (6)
Strength: FEEBLE (2)
Endurance: POOR (4)
Reason: TYPICAL (6)
Intuition: GOOD (10)
Psyche: REMARKABLE (30)

Health: 16
Karma: 46

Known Powers:

SPECIAL INTUITION. A Dire Wraith was killed while it was draining Cindy's memories, leaving a residue of the Wraith's consciousness in her mind. If she could make a successful Yellow Psyche FEAT roll, she could guess what the Dire Wraiths are up to if she had enough clues. The referee should decide how much she is able to guess.

DIRE WRAITHS™

Fighting: GOOD (10)
Agility: POOR (4)
Strength: REMARKABLE (30)
Endurance: REMARKABLE (30)
Reason: REMARKABLE (30)
Intuition: TYPICAL (6)
Psyche: GOOD (10)

Health: 74
Karma: 46
Resources : AMAZING

Known Powers:

SHAPE-SHIFTING. The Dire Wraiths most important power was their uncanny shape-shifting abilities. When faced with physical combat, the Dire Wraiths could change into the form of some alien beast more suitable for combat. The Dire Wraiths often took the form of the Deathwing:

F	A	S	E	R	I	P
Go	Ex	Ty	Re	Re	Ty	Go

Health: 66 Karma: 46

In Deathwing form, a Dire Wraith could fly at Typical speed and breathe fire one per turn for Incredible damage with Typical range.

SPECIAL ATTACK. The Dire Wraith's most insidious form of attack was its barbed tongue, which also secreted a powerful acid. The tongue instantly penetrated an unprotected human skull. If the skull was armored, the acid secretion and barbs of the tongue did Excellent damage to the armor each turn. Any item made of Monstrous material or better could not be pierced by the tongue.

The Beyonder removed all traces of Dire Wraith influence on Cindy's mind at the end of the Rom saga and resurrected her parents as well. Cindy's statistics may be used for a child in a similar predicament if desired.

ROCKETEERS™

Real names unknown

Fighting: EXCELLENT (20)
Agility: GOOD (10)
Strength: GOOD (10)
Endurance: GOOD (10)
Reason: TYPICAL (6)
Intuition: TYPICAL (6)
Psyche: TYPICAL (6)

Health: 50
Karma: 18

Known Powers:

BATTLE-SUIT. The Rocketeers wore special battle-suits which had rocket backpacks, enabling them to fly at Good speed and providing them with Good protection against physical attacks.

RANGED WEAPON. The Rocketeers carried special portable rocket launchers which had a four-area range and did Incredible damage. They each carried a maximum of five rockets at a time.

Special note: The original Rocketeers were human (from which the statistics above are derived). Later on, the Rocketeers were replaced by Dire Wraiths in human form.

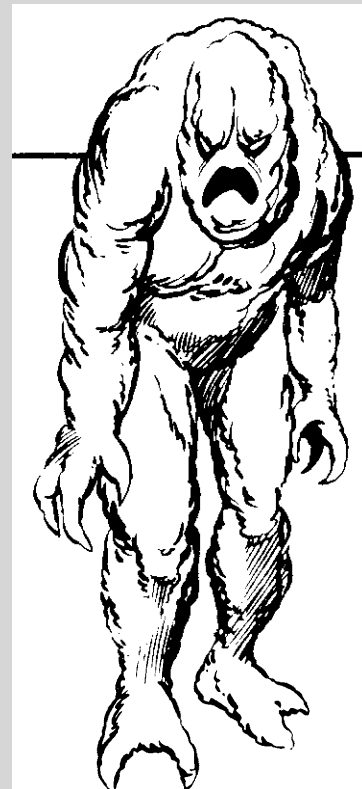

The tongue had range of one area. To successfully use the tongue, a Dire Wraith had to completely surprise a victim from behind or grapple an opponent and roll a hold result, indicating that the Wraith held the victim in front of itself.

The referee should allow a victim a dodge roll or escape roll before the Wraith's attack, because a successful hit indicates instant death to the victim. Right after the tongue hits, the victim's body turns into dust. The Wraith gains all the knowledge and memories of the victim, and the Wraith is now able to become a

THE HERO SYSTEM WILL KNOCK YOUR BLOCK OFF!

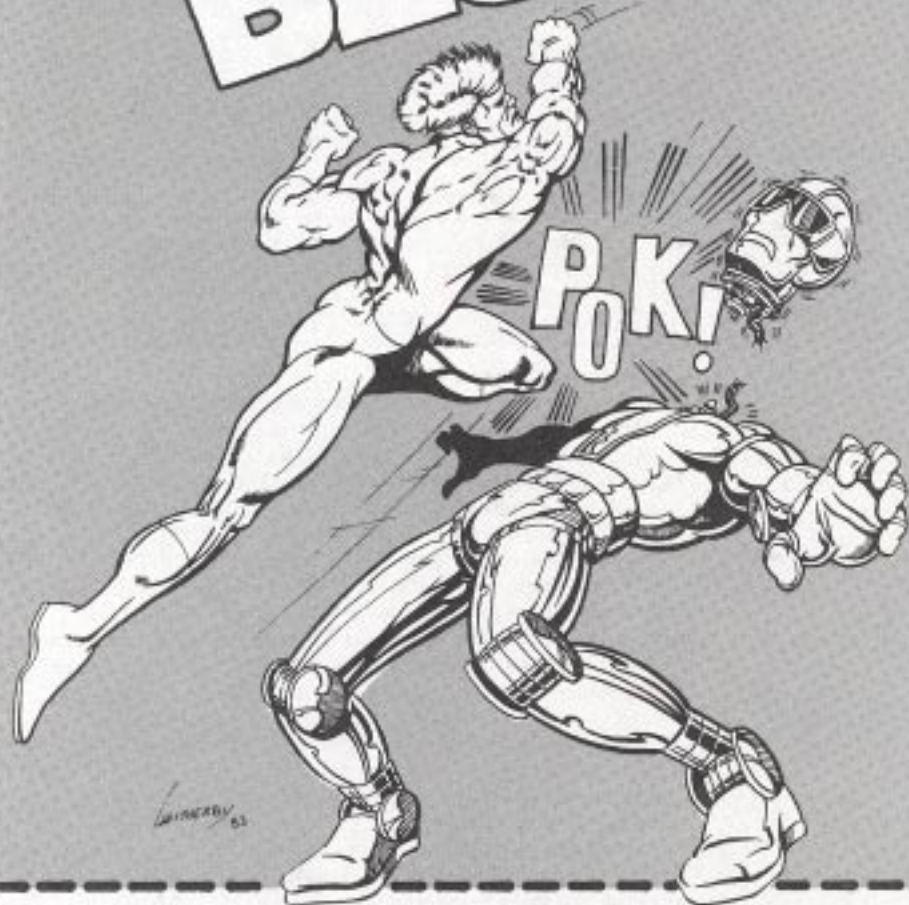

Champions, the super role-playing game, is a knockout!

The *Hero System* is more than *Champions* though — it's an interlocking system of games, adventures, sourcebooks and player aids. Together they form an action-packed playing environment. Two-fisted *Justice, Inc.* adventurers can battle evil side by side with *Champions* superheroes in the modern world of *Danger International* or in the mythical realms of *Fantasy Hero*. The compatibility doesn't stop there! *Hero System* adventures include game statistics for *Call of Cthulhu*, *Middle-earth Role Playing*, *Daredevils*, *Mercenaries*, *Spies and Private Eyes* and other popular systems. So get a head start — order now and play the *Hero System*.

PLEASE RUSH ME:

- CHAMPIONS (all the rules you need to be a hero) (US) \$12⁰⁰
- FANTASY HERO (complete guidelines for your fantasy universe) (US) \$15⁰⁰
- JUSTICE, INC. (relive the pulps & serials) (US) \$10⁰⁰
- DANGER INT. (rules for high-tech modern adventure) (US) \$15⁰⁰

For each order add (US) \$1⁰⁰ postage & handling. Canadians add (US) \$2⁰⁰. Send check or money order, no cash or COD. VISA & MASTERCARD orders call (800) 325-0472. VA residents, Canadians & overseas customers call (804) 295-0917. 1988 HERO GAMES.

NAME _____

ADDRESS _____

CITY _____

STATE, ZIP _____

SEND TO:
HERO GAMES
c/o IRON CROWN ENT.
P.O. BOX 1605
CHARLOTTESVILLE, VA 22902



perfect duplicate of the victim, down to the victim's voice. After taking a new form, the Wraith's physical abilities become those of the form taken. The Wraith loses all normal abilities and vulnerabilities except for its shape-changing power. If more damage is taken than its new form can withstand, it is forced to return to its true shape, and the previously taken damage is retained.

HEAT RESISTANCE. The Wraiths originated from a planet with a great deal of volcanic activity. They took half damage from fire- and heat-based attacks. At the same time, they took double damage from cold-based attacks.

MAGIC. The Dire Wraith species consisted of two branches: the males, who were experts in advanced technology, and the females, who were spell-casters. Female Wraiths had Monstrous Psyches and Good Reason scores (see pages 10 and 32 of the Campaign Book for rules concerning magic).

HELL HOUNDS™

Fighting: EXCELLENT (20)
 Agility: EXCELLENT (20)
 Strength: GOOD (10)
 Endurance: REMARKABLE (30)
 Reason: FEEBLE (2)
 Intuition: GOOD (10)
 Psyche: POOR (4)

Health: 80
 Karma: 16

Known Powers:

PHASING. The Hellhounds had a phasing power similar to that of Shadowcat™. Any machinery a Hellhound phases through must make an Endurance FEAT roll or be scrambled and inoperative. Machinery without an Endurance score is scrambled automatically. Mechanical beings take Incredible damage, while battle suits and other machinery is made inoperative for 10 turns.

The Hellhounds attack with their phasing ability, using a Fighting FEAT roll to determine success. A success roll indicates that the Hellhound has phased through the person, causing Remarkable damage. Also, the victim must make a yellow Endurance FEAT roll or fall unconscious for 1-10 turns.

Background: When the Dire Wraiths first arrived on Earth, they used their advanced technology to mutate ordinary dogs into these powerful creatures.

HYBRID™

Fighting: GOOD (10)
 Agility: EXCELLENT (20)
 Strength: GOOD (10)
 Endurance: MONSTROUS (75)
 Reason: EXCELLENT (20)
 Intuition: EXCELLENT (20)
 Psyche: UNEARTHLY (100)

Health: 115
 Karma: 140

Known Powers:

FLIGHT. Hybrid was able to fly at Typical speeds using his mental abilities.

MENTAL ATTACK. Hybrid was able to project mental blasts which could do up to Unearthly damage.

MENTAL POWERS. Hybrid had the powers of telepathy, image generation, telekinesis, and mind control at Unearthly levels.

BODY ARMOR. Hybrid's skin provided him with Excellent protection against all physical attacks.

SHAPE-SHIFTING. Hybrid had a Monstrous shape-shifting ability.

MAGIC. Hybrid had powerful magical abilities, using Personal and Universal energies with Remarkable skill.

Background: Hybrid was the first offspring of a human and a Dire Wraith, and was a sworn enemy of Rom.

Spaceknight character generation

Though most players may want to play Rom or Starshine in a MARVEL SUPER HEROES campaign, some players might want to create their own Spaceknight characters. This section helps players do this. First of all, the procedure for rolling a hero's abilities is changed as follows:

Fighting. Roll on the following table:

Die roll	Fighting score
01-60	Excellent
61-80	Remarkable
81-96	Incredible
97-99	Amazing
00	Monstrous

Agility and Strength. Roll on the following table:

Die roll	Ability score
01-10	Excellent
11-30	Remarkable
31-70	Incredible
71-90	Amazing
91-00	Monstrous

Endurance. Roll on the following table:

Die roll	Endurance score
01-30	Amazing
31-90	Monstrous
91-00	Unearthly

Note that Endurance scores refer only to the need for rest, as Spaceknights could withstand exposure to deep space indefinitely.

Reason and Intuition. Roll as per the rules in the Campaign Book, but shift the results two ranks to the right, to represent the fact that the characters come from an advanced race. The characters have been fighting the Wraiths for a long time, too, which would increase their scores in general.

Psyche, Roll as per the normal Campaign Book rules.

All Spaceknight characters have the same flight, body armor, and regeneration abilities possessed by Rom and Starshine. In addition, each Spaceknight character may roll randomly for 1-2 extra powers using the hero-creation section in the Campaign Book. Some variations should be made to the powers, as noted below.

Resistances and Senses: Protected Senses, Extraordinary Senses, and Infravision are possible.

Movement: Lightning Speed and Teleportation are possible.

Nature Control: Not possible.

Energy Control: All powers are possible.

Body Control: All powers are possible except Plasticity, Shape-shifting, and Body Transformation.

Distance Attacks: All are possible.

Mental Powers: All are possible.

Body Alteration (offensive): All are possible.

Body Alteration (Defensive): All are possible.

Weapons: Only Unique Weapon are possible.

Keep in mind that these super powers are produced and made possible by the Spaceknights' advanced battle suits. The power ranks of their powers, after being randomly rolled, should be shifted to the right one column to indicate they have been created by an advanced technology. A power's rank should have a maximum of Monstrous.



The Quest is Over.

At last, you have found the mighty source for authentic Fantasy-Wear apparel. The Fantasy-Wear line comes alive with all new high quality screen printed designs on a selection of durable, heavy-weight T-Shirts and sweatshirts. Order your Fantasy-Wear T-Shirt or sweatshirt now while supplies last. Finally, it is your chance to wear the mark of fantasy and adventure.

FANTASY-WEAR ORDER FORM

PRINT OR TYPE ALL INFORMATION BELOW

Name _____

Address _____

City _____ State _____

Zip _____ Phone _____

Method of payment (check one) Check Money Order Visa Mastercard **DO NOT SEND CASH**

CREDIT CARD NUMBER _____ EXP. DATE _____

Signature (as shown on credit card) _____

Fill out your completed order. Indicate size and quantity of garments desired. Check and Money Order made payable to:

Fantasy-Wear, P.O. Box 1443, Waukesha, WI 53187-1443

Offer good only in U.S. Allow 4-6 weeks for delivery. Only original order form or photo copy of form will be accepted.

PLEASE DOUBLE CHECK YOUR ORDER TO AVOID DELAY. THANK YOU.

GARMENTS PRINTED BY HOLDBECK, INC.

ADVANCED DUNGEONS & DRAGONS, DUNGEONS & DRAGONS, DRAGON, and DRAGONLANCE are trademarks owned by and used under license from TSR, Inc. ©1985 TSR, Inc. All rights reserved.

Description	Price	Indicate quantity in the appropriate boxes				Total
Dungeons & Dragons® white sweatshirt 50/50 Poly cotton	\$14.95	Small 92400	Medium 92401	Large 92402	X-Large 92403	\$
Dungeons & Dragons® 100% cotton white T-shirt (not pictured)	\$ 9.95	Small 92404	Medium 92405	Large 92406	X-Large 92407	\$
Dragon® Magazine 100% cotton grey T-shirt	\$ 8.95	Small 92408	Medium 92409	Large 92410	X-Large 92411	\$
Advanced Dungeons & Dragons® white sweatshirt 50/50 poly cotton	\$14.95	Small 92412	Medium 92413	Large 92414	X-Large 92415	\$
Advanced Dungeons & Dragons® 100% cotton yellow T-shirt (not pictured)	\$ 9.95	Small 92416	Medium 92417	Large 92418	X-Large 92419	\$
DragonLance™ 100% cotton light blue T-shirt	\$ 9.95	Small 92420	Medium 92421	Large 92422	X-Large 92423	\$
					Subtotal	\$
					5% Wisconsin State Tax (Wisconsin residents only)	\$
					Shipping/Handling	\$2.00
					Total	\$

For a Fistful of Credits

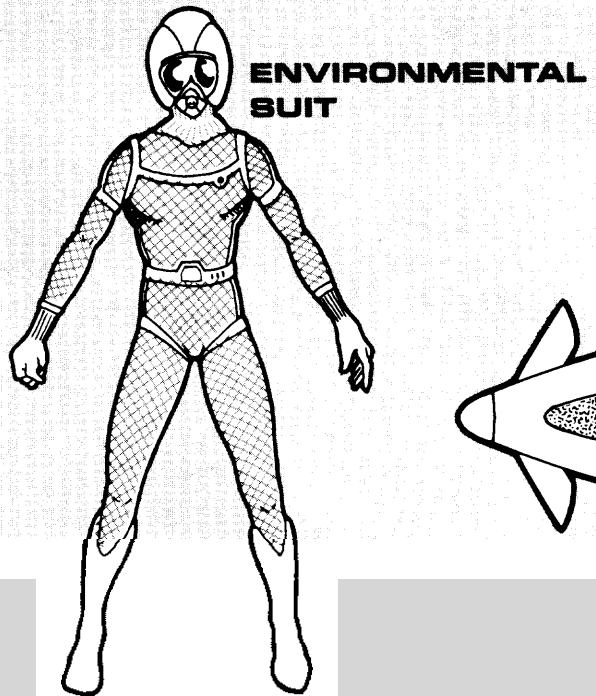

Editor's introduction — We've received a lot of requests for more equipment that can be used on star-faring expeditions, and this article will hopefully fill in some of the gaps. The following material was produced before SFAC 3, *Zebulon's Guide to Frontier Space*, was released. It fits in with the original STAR FRONTIERS® game system, and it may be used by gamers who do not have access to the former product. Some modifications will be required if the *Zebulon's Guide* revisions are being employed in a campaign.

Gyrojet ammunition

Doze jetclip. The doze jetclip is loaded with 10 rockets, each carrying a small amount of doze gas. The rockets burst on impact, causing no damage, but filling a one-meter area with doze gas. The target must pass a current Stamina check or fall unconscious for 1-100 turns. The doze gas is only effective on the round it is fired. These rounds are often used by police or security forces to take suspects alive.

Poison jetclip. The poison jetclip also has 10 rockets, each carrying a small dose of poison gas that will affect a one-meter area. When the target is hit, no damage is done, but a current Stamina check must be made. Those that fail will be affected by a S5/T10 poison. If the character passes the check or is wearing a gas mask or spacesuit, he will not be affected. A shot of antitox will neutralize the poison so no further damage is taken.

Tangler jetclip. This jetclip has 10 rockets filled with tangler fluid. No damage is caused when a target is hit, but a one-meter area is filled with tangler threads. The target may avoid being caught in the threads if a Reaction Speed avoidance roll is made. Otherwise, the threads will last for 30 minutes. Creatures with more than 100 Stamina points may break free in one turn.

Defensive Suits

Slipsuit. A slipsuit is a tight-fitting suit made from a special low-friction polymer. It covers the entire body. The hands and feet are made from normal material, allowing the character to grip, punch, and walk normally. The slipsuit makes its wearer harder to hit with most weapons in melee combat. The attacker is -20 on his chance to hit a character wearing a slipsuit, unless he is attacking with a sonic knife or sonic sword. Tangler grenades and tangler rockets will not stick to a character wearing a slipsuit, making it impossible to tangle a character wearing one. A slipsuit will be ruined once it has taken 100 points of damage.

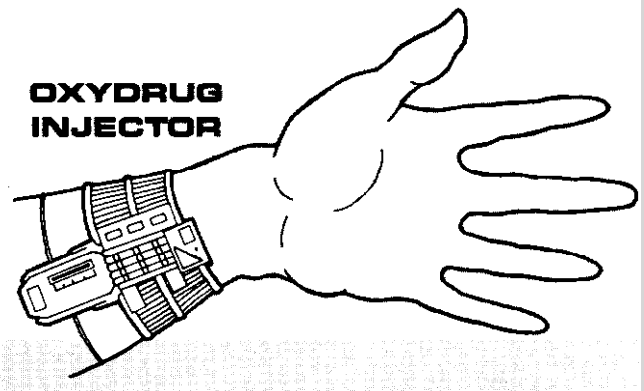

Organic computers are the cousins of the standard STAR FRONTIERS computer. Like normal computers, they are used to store and analyze information. However, they have many important differences.

Unlike a normal computer, which is made of electronic circuits, superconductors and specially formed crystals, the organic computers is grown from molecules. These are organic molecules, the same kind that form the building blocks of plants and creatures. This makes organic computers much smaller than the normal computers. Organic computers, however, are not considered to be living consciousnesses.

Since the organic computer is grown, it cannot be expanded like a regular computer (by adding function points). Instead, an organic computer has a function point potential. This is the maximum number of function points an organic computer can use at one time (and therefore the maximum number of programs that can be used at one time). However, programs can be entered and then later removed from an organic computer without damage to the computer or the program. It takes one turn to change the program of an organic computer. Unlike normal programs, when

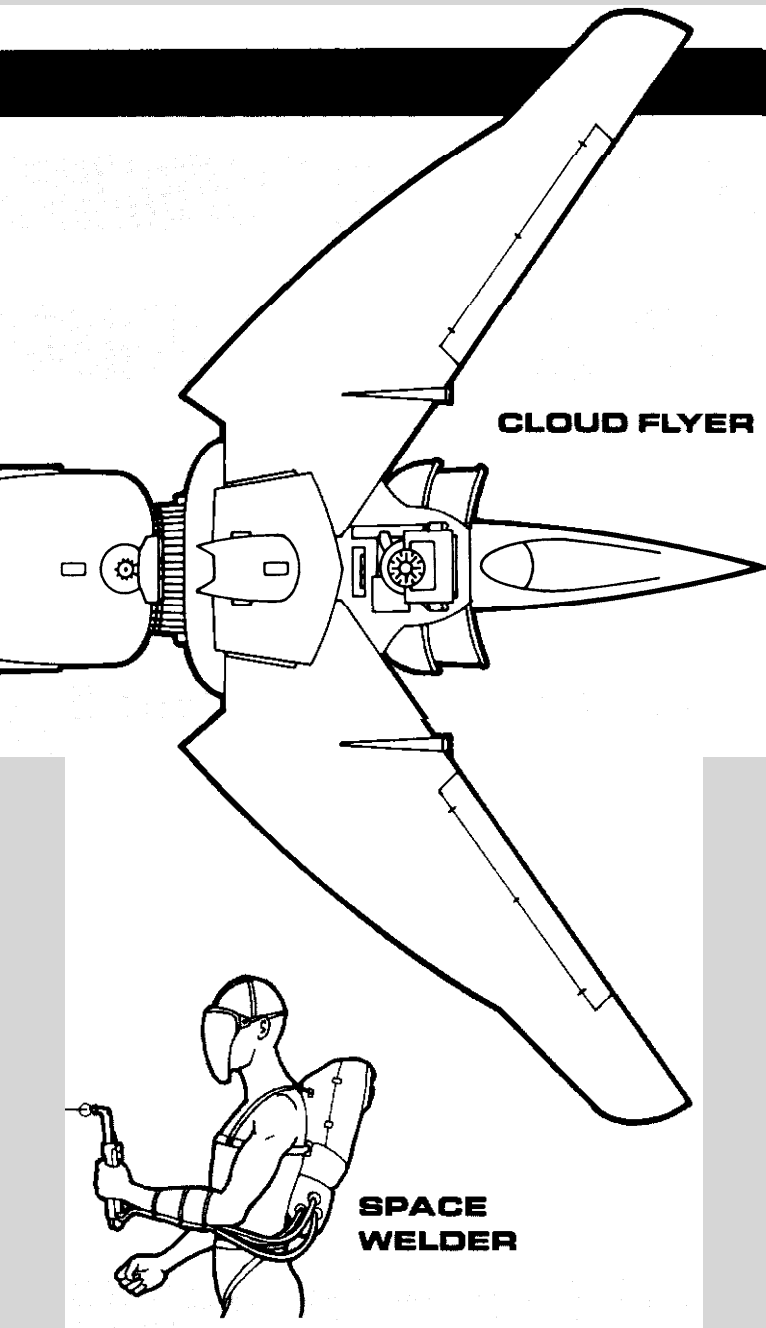

different from a normal computer; it is surgically placed inside a person or creature and becomes part of that person's brain. Its power is obtained from the food the person eats. An implanted computer interfaces with other computers by a micro-transmitter/receiver that is part of the implant. The computer interfaced to will require a similar transmitter/receiver as part of its equipment. Programs for an implanted computer are read by the person and "stored" in his memory. The implanted computer then draws these programs out of the person's memory. A character may have as many programs memorized as his Logic Ability divided by 10. These programs may be of any level. If the character is ever injured to zero Stamina points or below, the implanted organic computer is destroyed. This is true even if the character is placed in a freeze field and later revived.

For example, Zir-Zak (our Vrusk friend) has an implanted level 1 organic computer. His Logic Ability is 65, so he may store up to seven programs in his mind. The programs can be of any level, but Zir-Zak may only use 10 function points at any one time.

Important: Characters with implanted organic computers do not become supermen! They simply have access to a computer at all times. If a character attempts to have his computer solve something with too many variables, it will be beyond the abilities of the program. With any program, the character must still supply exact instructions and data. Computers cannot guess outcomes or predict events without a great deal of information.

Organic computers may only be implanted at the largest of hospitals with the most advanced of techniques. The process is very expensive and requires one month of hospital time for each level of the computer. The table below lists all the information on function point potential, size, and costs.

a character buys an organic computer program, he is buying a set of pre-recorded instructions that tell his organic computer what to do. He is not buying the hardware needed to run the program. Different programs may be used at different times, but the potential cannot be exceeded by programs that are in use. The function points used by programs are the same as those listed for standard computer programs.

For example, Zir-zak, a Vrusk adventurer, has a level 2 organic computer. Its function point potential is 30. He is using the computer to manage certain areas of his spaceship. He could have a level 4 computer security program (16 function points), a level 2 life support (8 function points), and a level 2 installation security (6 function points) running at the same time. If he landed on a planet and wanted to use a language program, he would have to change one of the programs in the organic computer to do so. In this case, he decides life support is not needed and replaces it with a level 4 language program.

An organic computer may either be housed or implanted. A housed organic computer is much like a normal computer. The actual processing part of the computer is kept in a small tank filled with nutrients. Connections to it allow the computer to be interfaced with other computers and machinery. Its advantage is its extremely small size. An implanted organic computer is much

New equipment: Cost and mass table

Item	Cost (Cr)	Mass (kg)
Gyrojet ammunition		
Doze jetclip, pistol	20	—
Doze jetclip, rifle	30	—
Poison jetclip, pistol	50	—
Poison jetclip, rifle	100	—
Tangler jetclip, pistol	30	—
Tangler jetclip, rifle	60	—
Defenses		
Slipsuit	600	1
Computers		
Organic computers	*	*
Computer receptor implant	*	*
Computer programs		
Infiltration	*	*
Medical technology		
Accelerator drug	10	—
Anesthetic drug	5	—
Cloning	*	*
Experiential matrix analysis	*	*
Intensive healing	*	*
Oxy drug injector	500	—
Oxy drug refill	30	—
Regeneration	*	*
Universal antibody	100	—
Vehicles		
Cloud flyer	40,000	4,000
Miscellaneous equipment		
Density scanner	500	5
Environmental suit	100	2
Enviro-proofing	*	*
Portable space welder	300	20
Thermosign generator	1,000	100

* — See description.

Organic computer information table

Computer Level	Function Point	Cost (Cr)/Mass (kg)	
	Potential	Housed	Implanted
1	10	10,000/-	100,000/*
2	30	35,000/1	400,000/*
3	100	125,000/2	1,000,000/*
4	250	300,000/2	2,000,000/*
5	600	700,000/3	5,000,000/*
6	1500	2,000,000/3	10,000,000/*

* – Implanted computers are extremely small. They will have no effect on the carrying capacity, health, or appearance of the character.

Computer receptor implant

The computer receptor implant will allow the user of the implant to be in contact with his computer at ranges up to five kilometers. The user simply “thinks” his request to the computer. The computer (if it has the proper program) will then send an answer to the user, where it will be “heard” as a thought in his brain. So long as the user stays within range, he will be in contact with his computer.

When a character buys a computer receptor implant, he is actually buying a special implant, an attachment to his computer, and a special transmission program. The implant is a micro-transmitter/receiver with special connections that attach to the nerve cells of the user. This implant must be surgically attached to the character (just under the skin). This work can only be done at an advanced hospital (referee’s decision where) and takes two weeks. The computer attachment is a similar transmitter/receiver that connects to the computer. The transmission program allows the two transmitter/receivers to talk to each other, and uses one function point. This program has no levels. The computer receptor implant costs 50,000 Cr. Transmitter/receivers that attach to other computers cost 2000 Cr each.

Computer programs

Infiltration. Infiltration programs are designed to help a person with computer skill defeat the security on other computers and detect security overrides. There are six levels of infiltration programs. Each level will add 5% to the character’s chance of success. The amount of time needed to defeat security or perform a security override when using an infiltration program is changed to 10-100 minutes. To be used, the computer with the infiltration program must be successfully interfaced to the other computer. Defeat Security is not required to make this interface. Infiltration programs require the same amount of function points as computer security programs.

Medical Technology

The following items are new pieces of medical equipment and new medical processes. The processes may only be performed at hospitals with sophisticated medical equipment.

Accelerator drug. This drug speeds up the body’s actions. Only a medic may administer this successfully. When under the effects of the drug, a character adds +2 to the initiative die roll (in addition to normal bonuses) and can make one extra attack per turn in melee combat. The effect will last for a number of turns equal to the character’s Stamina score (at the time the drug is taken) divided by 10. Each turn the character is accelerated, the person will lose four Stamina points. Lost points are healed like normal wounds.

Anesthetic drug. This drug works exactly like a doze grenade, except that it must be injected into the target. Anyone may give the injection.

Cloning. This process is very rare, performed at only the most advanced hospitals. When a character is to be cloned, tissue sam-

ples are taken of various parts of the character’s body. These may be held for any length of time. From these samples, a new body may be grown when requested. Growing a clone takes 500 days and costs 1,000,000 Cr. Physically, the clone will be identical in appearance to character from which the tissue samples were taken, save for scars and other uninherited physical traits. The clone will have average scores in Strength, Stamina, Reaction Speed, and Dexterity. It will have no Intuition, Logic, Personality, Leadership, or Special Abilities. A clone may be supplied with these abilities through an experiential matrix (giving the clone the scores recorded in the Matrix, see below). If a matrix is fed into a clone different from the person from whom the matrix was taken, the Strength, Dexterity, Reaction Speed, Personality, and Leadership scores are reduced by 20 points. No score may be reduced below a level of six in this case. Clones and cloning are illegal on some worlds.

Experiential matrix analysis. Living characters may undergo an experiential matrix analysis. This process will record all memories and experiences of the character up to the time of the analysis into a special computer storage. The process is mainly used to transfer memories to a clone, and may only be done at an advanced hospital. This process is dangerous as it involves severe strain on the character; there is a 20% chance that the following abilities will be permanently reduced whenever an analysis is made: Stamina, Logic, Intuition, Reaction Speed, Personality, and Leadership. One check is made for each ability. If an ability is to be reduced, the character will lose 10-50 points in that ability. All abilities (except Stamina) may not be lowered to less than six points. If the Stamina ability is reduced to zero or below, the character is permanently dead. The referee should record the reduced Ability Scores of the character analyzed and keep this information for later use. Reduced abilities may only be increased by use of experience points. The analysis takes one week and costs 50,000 Cr.

Intensive healing. Intensive healing may only be done at sophisticated hospitals. The referee should decide if a hospital is able to do intensive healing. Intensive healing will allow the character to heal 40 Stamina points a day. The cost is three times the number of points healed per day plus 500 Cr. Healing 85 Stamina points would take three days and cost 755 Cr.

Oxy drug injector. This slowly releases oxygen into the bloodstream, supplying all needs for twelve hours. Oxy drug injectors are usually worn on the wrist, feeding the drug directly into the blood. The injector must be attached at a hospital. Once the injector is attached, the character may refill it with oxy drug as needed. The cost of a refill is noted on the price list. Note that an oxy injector will not protect a character in space; a spacesuit MUST be worn.

Regeneration. This process allows lost arms, legs, fingers, and toes to be regrown by the use of special medical stimulation procedures. It may only be done at the most advanced hospitals. The patient, obviously, must be alive (or in a freeze field) when brought to the hospital. Regeneration takes 30 days for a finger or toe (costing 50,000 Cr) or 90 days for a complete arm or leg (costing 200,000 Cr). How the character lost the limb in the first place is left entirely up to the referee. If the referee does not want to deal with this, the game problem of limb loss and regeneration may be ignored. Since Dralasites do not have any specific limbs, they do not need regeneration.

Universal antibody. This antibody helps protect the person from any type of disease. It may only be injected at a hospital. Characters with the universal antibody have a +20% chance to resist any disease (if the chance to resist the disease is 0% (nil), the character is given a 20% chance). This product is a great boon to galactic tradesmen and explorers of new worlds.

Vehicles

Cloud flyer. The cloud flyer is an atmosphere craft specially designed for use in hostile environments. It has a completely pressure-sealed cabin and cargo area to protect the occupants and

equipment from the environment. A cloud flyer's main wings are swept back, and it has a shorter pair of wings, or canards, mounted near the nose.

Cost: 40,000 Cr (rental fees - 200 Cr down, plus 100 Cr/day)

Top/cruise speed: 400 kph/150 kph

Passengers: 6

Cargo limit: 3,000 kg, 3 cubic meters

Miscellaneous equipment

Density scanner. This device consists of a bulky backpack connected to a large cameralike set of goggles. The user wears the goggles, which show the scene in front of him. The density scanner checks emissions from the electromagnetic spectrum and computes the density of the items observed. It can only give very general readings. The scanner is often used for locating hidden cables and wiring for repairs. The scanner does not really "see through" things. It only gives the density reading of the surfaces of things. The density scanner must be supplied with SEU to operate, and it uses 1 SEU for every 10 minutes of operation.

Environmental suit. This suit is designed to protect its wearer from the weather and other conditions on habitable planets. It is made of lightweight, quilted cloth. The suit covers the entire body and has a built-in gas mask, goggles, and a small heating/cooling system. This will keep the suit cooled to a comfortable temperature on hot planets and warm on cold planets. The suit also protects against tainted atmospheres, airborne irritants, and dust and sandstorms. Any field may be used with the suit, and it may be worn under an albedo suit or skinsuit. It may not be worn under a slipsuit. The environmental suit itself gives no protection from attacks. The suit may be powered from a power pack or power-clip. It uses 1 SEU per day, if the heating/cooling system is used.

Enviro-proofing. This treatment may be given to any article of equipment or vehicle except hover vehicles. Enviro-proofing pro-

protects these items from the extremes of heat, cold, dust, submersion, tainted atmospheres, and vacuum. The referee should note that there are no specific rules for equipment failure in the STAR FRONTIERS Expanded Rules. Enviro-proofing is provided to protect equipment in situations in which the referee feels weather may affect the item. It is up to the referee to create other planets and situations where it would be useful. Enviro-proofing may be done when the item is bought or at some later time. The cost to enviro-proof an item is 10% the cost of the item.

Portable space welder. The portable space welder is an all-environment welder. It will work in all conditions, including in vacuum, underwater, and in poisonous or tainted atmospheres. It is similar to a modern oxyacetylene torch and uses an open flame for its welding and cutting. It may be used to weld metals and hardened plastics or to cut through these materials. It takes the welder one turn to make a weld or cut 50 cm (.5 meters) long. The welder may cut through up to 3 cm of material. The welder may only be used in melee combat and no bonus is added for Melee Weapons skill. If a hit is scored, the target will suffer 5-50 points of damage from the flame. A fuel tank is required to operate the welder. One tank will fuel the portable space welder for one hour.

Thermosign generator. The thermosign generator is an advanced form of the infrared jammer. It creates an infrared image of something that is not actually there by generating the proper heat patterns. This image will be seen on all infrared goggles and sensors. The thermosign generator has a 10-meter radius; it may create nothing larger than this radius. Creatures and items inside this radius will not be seen on infrared sensors. An image disc is required for the generator to create the infrared image. These discs must be custom-made and cost 100 Cr each. The generator is approximately a one meter cube. It requires a parabatery to operate. The generator uses one SEU each hour of operation.

Ω

THE ORIGINAL BRUCE LEE MARTIAL ARTS GAME



THE LEGEND LIVES
LIMITED COLLECTOR'S
EDITION

NIGHT of the NINJA

Can you think like a Ninja?
Do you expect the unexpected?
Role playing that's real and deadly?

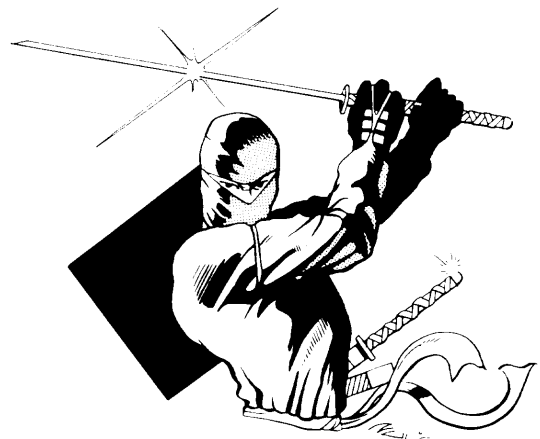

IIE GAMES
CORPORATION

962 James St., Penticton, B.C., Canada V2A 4A7

(604) 493-5420

Convention Calendar

MADNESS '86, Aug. 9-10

This comic book, gaming, and science fiction convention will be held at Middletown High School in Middletown, N.Y. Preregistration fees are \$8, and \$10 at the door. For more details, send a self-addressed, stamped envelope to: Madness '86, 9 Sheffield Drive, Middletown NY 10940.

VALLEYCON '86, Aug. 9

This science fiction, gaming, and comic book convention will be held at the Veteran's Memorial Building in Tulare, Calif., from 10 a.m. to 8 p.m. There will be open and organized gaming, movies, exhibits, speakers, a dealers' room, and costume and trivia contests with cash prizes. Registration is free. For more information, contact: Big Mike's Video, 1766 E. Tulare Ave., Tulare CA 93274.

GEN CON® 19 GAME CONVENTION, Aug. 14-17

This annual gaming convention, sponsored by TSR, Inc., will be staged at the MECCA Auditorium and Convention Hall in Milwaukee, Wis. For more information, contact: Marti Hayes, P.O. Box 756, Lake Geneva WI 53147.

DRAGONFLIGHT '86, Aug. 22-24

This gaming convention will be held in the Campion Tower at Seattle University from 4 p.m. Friday until 7 p.m. Sunday. Sponsored events will include role-playing game tournaments and open games, boardgames, miniatures, and computer games. There will also be on-site housing, food services, a dealers' room, and a game auction. Preregistration is \$18 with no event fees. For more information, contact: Dragonflight, P.O. Box 417, Seattle WA 98111.

ALPHACON I, Aug. 27-31

This gaming convention will be held at the Meadowlands in N.J. A variety of games and game tournaments will be offered, as well as personal and corporate display booths. Advance registration fees are \$21.99; registration fees are \$25.99, or \$7.99 for a one-day pass. For more information, contact: S. Bugaj, P.O. Box 1997, East Hampton NY 11937.

POLYCON '86, Aug. 30-Sept. 1

This gaming convention will be staged at the California Polytechnic State University in San Luis Obispo, Calif. A variety of wargaming and role-playing tournaments will be featured. For more information,

contact: S.A.G.A./Polycon, Box 168, Julian A. McPhee University Union, Cal Poly State University, San Luis Obispo CA 93407.

AUTUMN CAMPAIGNS '86, Sept. 6-7

Sponsored by the Lexington Historical Gamers Society and the Rusty Scabbard hobby shop, this convention will take place at the Lexington Hilton Hotel in Lexington, Ky. Events will include board games, historical miniatures, and fantasy and science fiction role-playing games. For more details, send a SASE to: Lexington Historical Gamers, c/o The Rusty Scabbard, 513 E. Maxwell St., Lexington KY 40502.

KING CON II, Sept. 6

Sponsored by the Knights of the Griffin, this gaming convention will be held at the Mount Vernon City Park in the Roland Lewis Community Building in Mount Vernon, Ill. Advance registration is \$4 (plus \$1 if you wish to participate in the AD&D tournament). Other activities will include a figure painting contest, games dealers, an art show, and lots of free gaming. For further information, contact: Convention HQ, c/o The Dragon's Lair Game Shop, 1311 N. 13th, Mount Vernon IL 62864.

EARTHCON VI, Sept. 19-21

This science fiction convention will be held at the Holiday Inn at Rockside Road and I-77 in Cleveland, Ohio. Guests of honor will include Gordon R. Dickson and C.J. Cherryh. Videos, a masquerade, an art show, and an auction will also be offered. For more details, contact: Earthcon, P.O. Box 5641, Cleveland OH 44101.

NOWSCON '86, Sept. 27-28

Sponsored by the Northern Ohio Wargaming Society, this convention will take place at the Brookpark National Guard Armory in Brookpark, Ohio. Miniatures and role-playing tournaments will be offered. For further details, contact: Nowsccon '86, P.O. Box 29116, Parma OH 44129.

SUNCOAST SKIRMISHES '86, Oct. 3-5

This wargaming tournament will be held at the Asheley Plaza Hotel. A variety of wargames and role-playing games will be featured. For more information, contact: Suncoast Skirmishes, 2550 34th Ave. N., St. Petersburg FL 33713.

ENCOUNTER 10, Oct. 4-6

This science fiction and fantasy convention will be held at the Wichita Hilton Inn

East. Guests of honor include Fritz Leiber and Gene Roddenberry. Registration fee is \$15. For more details, contact: FANdom, P.O. Box 1675, Wichita KS 67201.

FRONTIER WAR 2.5, Oct. 4-5

This gaming convention will be held at the Miller Park Pavilion in Bloomington, Ill. Registration fees are \$5 until Sept. 20, and \$6 thereafter. For more information, contact: Frontier War 2.5, c/o Steven Miller, 511 W. Mulberry, Apt. 2, Bloomington IL 61070, or telephone (309) 827-7817.

CHICAGO MODEL AND HOBBY SHOW, Oct. 9-12

Sponsored by the Radio Control Hobby Trade Association, this game, model, and hobby show will provide a variety of product sales and demonstrations. This second annual event will be held at the O'Hare Expo Center. For further information, contact: Susan P. Lind, toll free, at (800) 323-5155 (in Illinois and Canada, call (312) 299-3131).

U-CON 4, Oct. 10-12

This convention will be staged at the Coffman Union at the University of Minnesota in Minneapolis, Minn. For details, contact: Conflict Simulation Association, U-Con 4, University of Minnesota, 235 Coffman Union, Minneapolis MN 55455.

ADVACON, Oct. 12

This gaming convention will be held at the Polish Falcon Hall in Depew, N.Y. Fantasy and science fiction role-playing games, board games, and miniatures tournaments will be among the featured events. Preregistration fees are \$3, and \$3.50 at the door. For details, contact: The Advacon Fellowship, 101 Floss Ave., Buffalo NY 14211.

CONTACT '86, Oct. 17-19

This science fiction and gaming extravaganza will be held at the Ramada Inn in Evansville, Ind. Guests include David R. Palmer, Stanley Schmidt, Frank Mentzer, and Penny Pettitcord. Other events will include RPGA tournaments, a miniatures contest, and an art show. Registration fees are \$12 until Oct. 1, and \$15 thereafter. For further information, contact: RCSFA, P.O. Box 3894, Evansville IN 47737.

RUDICON '86, Oct. 17-19

This gaming convention will take place on the RIT campus in Rochester, N.Y. Featured at this convention will be a variety of events, including wargames, role-playing games, a dealers' room, movies, and tournaments. Registration is \$7, and \$5 for students with ID. For more details, write to: The Rochester Wargamers Association and Guild, c/o Student Directorate, One Lomb Memorial Drive, Rochester NY 14623, Attn: William Trainor.

PALLADIUM BOOKS SPECIAL OFFER AVAILABLE AT THE GEN CON® 19 CONVENTION

The Palladium Role-Playing Game ONLY \$10.00!

☞1986 Special Convention Coupon!☞

WOW! The normal 274 page, \$19.95 Palladium RPG for only \$10.00!! Let me have one!

Name: _____

Address: _____

City: _____ State: _____ Zip: _____

SORRY NO MAIL ORDERS.

That right! Palladium Books' 274 page, fantasy, RPG extravaganza will be offered at HALF price, ten dollars (normally \$19.95!) This special is being offered ONLY at GEN CON® 19 Convention and will not be repeated. Let us squash any silly rumours this special promotion might cause. NO the Palladium RPG is not being discontinued. In fact, the Palladium RPG continues to be our best selling game, second only to the sensational Teenage Mutant Ninja Turtles! Yes there will be more game adventure supplements; the latest of which, Adventures on the High Seas, makes its debut in September.

To take advantage of this special offer just present this coupon (or the one from the program book) at the Palladium Books exhibitor display.

New At GEN CON® 19 Convention From Palladium Books!

- The Revised RECON
- Teenage Mutant Ninja Turtles Adventures (supplement)

Plus . . .

- Teenage Mutant Ninja Turtles & Other Strangeness
- After the Bomb (T.M.N.T. Supplement)
- The Mechanoids (compatible with T.M.N.T.)
- Heroes Unlimited (compatible with T.M.N.T.)
- The Justice Machine (compatible with T.M.N.T.)
- Palladium Book II: The Old Ones
- The Palladium Book of Monsters and Animals
- The Palladium RPG Game Shield
- The Palladium Weapons and Armour Series
- Original Art by Siembieda and Gustovich
- FREE Ninja Turtle Posters by Kevin Eastman with any purchase (while supply last)
- Meet Erick Wujcik, designer of the Ninja Turtle game.
- Impromptu open gaming and more!

DISCOVER THE MAGIC OF PALLADIUM BOOKS!

GEN CON is a registered trademark of TSR Inc.
Teenage Mutant Ninja Turtles is a registered trademark of Mirage Studios.
All others copyright and trademark by Palladium Books.

Special Offer Number Two!

Regrettably we cannot extend the Palladium RPG offer through the mail, but to soften the blow we can offer our spectacular promo-poster for our NEW game supplement Teenage Mutant Ninja Turtles Adventures. The poster is a FULL COLOR reproduction of the cover painting by Kevin Eastman. This is a promotional poster and not made available for retail.

☞Ninja Turtle Poster Coupon!☞

Okay, send me ONE 15×20 full color PR poster. Enclosed is \$2.00 to cover postage and handling (mailed folded in quarters).

Name: _____

Address: _____

City: _____ State: _____ Zip: _____

This poster better be good . . . and send me a catalog while your at it!

Mail Coupon to: Palladium Books
Coupon Offer
5926 Lonyo
Detroit, Michigan 48210

Note: The Ninja Turtle Poster is Not Shown Here.



Gamers' Guide

The Gamers' Guide offers a wide selection of advertisements & notices directed specifically to the game hobbyists.

Ad sizes range from 2" to 5" of column depth (column depth = $2\frac{5}{16}$ "). The 1 x rate per column inch is \$75. (Example: An ad measuring 3" tall would be calculated as $\$75 \times 3" = \$225.$)

Payment for space purchased in the Gamers' Guide must accompany an advertiser's insertion order. Upon receipt of payment and camera-ready copy, the ad will be placed in the next available issue.

For further information, contact Mary Parkinson, TSR, Inc., P.O. Box 756, Lake Geneva, WI 53147.

SPIRAL ARM

Spiral Arm is our latest play-by-mail game of strategic galactic conquest. Designed by The Australian Wizard, Spiral Arm features a map of over 650 stars, up to 50 players per game, economic production, 7 ship classes, 8 racial types, 4 modes of space movement, space and planetary combat, colonization, and technological development. You can name your Empire and new stars. The customized turnsheet is in a convenient "fill-in-the-blank format" for easy use in submitting orders.

Costs: Rules \$2.50

Turn fees: \$4.50 per turn

Game Entry: \$15.00

(Set-up and 3 turns)



FEUDAL LORDS

Feudal Lords is our original, and most popular, play-by-mail game of medieval power politics. Fifteen players struggle to become King of England after the death of King Arthur by means of medieval economic development, military conquest, and diplomatic intrigue. Feudal Lords features agriculture, trade, knights, mercenaries, ships, bribes, spies, and much more.

Costs: Rules \$2.50

Turn fees: \$3.00 per turn

Game Entry: \$10.00

(Rules, set-up, and 3 turns)

For further information on our games, write to:

GRAAF SIMULATIONS
27530 Harper
St. Clair Shores, MI
48081-1924



CAST YOUR OWN FANTASY FIGURES



10 New Molds
Fantasy Chess Set - Special Figures

SPECIAL

Fantasy Starter Set plus catalog
only \$11.30 post paid.
(A Regular \$19.35 Value)

Or send \$1.00 for catalog with color insert

THE DUNKEN CO.
P.O. Box 95D
Calvert, TX 77837
(409) 364-2020

Casting your own Figures
is almost as much fun
as playing the game.

Game Master's Guide™

dungeon master utilities

Creatively design and run FRP games FAST with GAME MASTER'S GUIDE™. Easy to use. Copyable. Listable. Modifiable!
GMI — All Dice Rolls, Critical Hits, Fumbles, Combat Tables, Items, Random Functions, Treasures, 14 Shops, Storage for 200+ Monsters, 51 Treasures, 51 Characters or NPCs, Dishes, Hall and More!
GMI — 7 Townies, each with background and multiple functions! 50 Tricks, that are sure to keep your players on their toes! Grand Tournament Grounds, 115 opponents that are always ready for a challenge! Shark Races! Troop generation (1-20k), Hall of Justice and More!
GMI — Create NEW, WHOLE Characters and Monsters, each with NAME, all stats, items, attitude, etc. Warning Armies that battle on Screen! 50 Bonus Tricks for GMI and More!
RAI/MORTH'S HOLLOW™ — Our first computer scenario! Includes: Maps, Keyboard overlay, Detailed Manual, Rai/Morth for the Apple™: \$29.95, GMI for the 512K Macintosh™: \$28.00, GMI/III for the Apple™, C-64™: \$24.95 each, 2 for \$42.50 all 3 for \$60.00. Add \$1.50 S/H to U.S. and APO. (CK, MO, MC, VISA) U.S. WALTER COMPUTER SERVICES — 32 Greenwood Avenue, Lancaster, PA 17603 or call (717) 299-4646

Artist for Hire



— Past - Check this out: —

Character Portraits

Illustrations

Computer Graphics

Satisfaction
Guaranteed

Free Catalog

send stamp to p.o. box 2488
WALTER MOORE, Auburn AL 36831

SEARCHING FOR ADVENTURE
GAMES AND SUPPLIES?



Forget the monsters — get the

WARGAMES WEST

Free Catalog

Write to:

WARGAMES WEST
3422 Central Ave. SE
Albuquerque, NM 87106

\$\$\$ Off

YOUR GAMING SUPPLIES

TSR • Avalon Hill • GDW
Ral Partha • Koplou • And More

For **FREE** Catalog or Order,
CALL 303/741-2727 OR WRITE

Mountain Mage
7871 S. Monaco Ct.
Englewood, CO 80112

VISA

MASTERCARD

FREE DICE

- D&D® Games, Fantasy Games
 - Space, Detective, War Games
 - Huge Selection — ALL YOUR GAMING NEEDS
 - Japanese Toys, Models & Books
 - COMICS — New & Collectable
- Send 50¢—refundable with 1st order

COMIC CASTLE

6512-F El Cajon Blvd.
San Diego, CA 92115
Dept. D (619) 265-2124

D&D is a registered trademark of TSR, Inc.



IMAGINATIVE MAIL ORDER

★ GREAT PRICES ★

RAL PARTHA **JAMES BOND**
GRENADIER **CAR WARS**
TSR **MORE!**

FAST SERVICE!

Send \$1 for Catalog
(Refundable with first order!)

Box 100
Hawleyville, CT. 06440

WITCH DOCTOR



PLAY BY MAIL

write to ARGONAUT PUBLISHING, dept. ae
Box 20672, Minneapolis, MN 55420

NEW by Andorian Enterprises

- Andor Campaign - Complete world setting for the more realistic role-player 100+ pages #3001 \$9.95
 - Cave of Spirits - Part one of the Tower of Darkness tetralogy. Levels 1st-3rd #3051 \$4.95
 - Oxen Ford - A Necromancer tries to take over a town. Levels 1st-3rd #3055 \$4.95
 - Tarkesh - A prince's wedding leads to adventure and foul play. Levels 1st-3rd #3062 \$4.95
- Add \$2.00 S&H
50¢ for Catalogue & Coupon free w/order
- P.O. Box 173
S. Lebanon, OH 45065
- All modules playable with any FRP system.

DREAM WIZARDS

THE SHOP OF THE FANTASTIC—Since 1978

Send \$2 for complete Catalog of all fantasy, science-fiction, military and computer games, miniatures, tarot, gaming aids, magazines and more! Gift miniature with each catalog.

Dept. K
P.O. Box 2246, Rockville, MD 20852
Phone Orders: (301) 881-3530

When in the Washington D.C. area visit our incredible shop—Congressional Plaza South, Rockville, MD. (across from Twinbrook Metro stop)

The Wizard's Corner

Saskatchewan's FRP Game Centre
Fantasy, Sci-Fi, & Wargames

801C Broadway Avenue
Saskatoon, Saskatchewan
Canada S7N 1B5

NOW with a second location:
2124B Broad Street
Regina, Saskatchewan

Drop in to either location, or send \$2 for catalog to Saskatoon address

DIAMOND DICE, Inc.

324 S. Fairview, Park Ridge, IL 60068
(312) 692-7165

All orders add \$1.00 for postage/Send \$1.00 for Catalog

MASTER DICE SETS

(6 different dice)

BONUS — 6 FREE 20 sided dice with each set ordered

94	Black Dice/Silver Ink	\$6.60
108	Diamond Dice/Blue Ink	\$7.50
112	Transparent Blue Dice/Silver Ink	\$7.50
115	Transparent Purple Dice/Silver Ink	\$7.50
8001	Diamond Dice/Uninked	\$4.50
8008	Transparent (Frosted), Uninked 6 Different Colors	\$4.50
1004	100 Transparent Assorted Dice (GOOD VALUE)	\$19.00
0001	8 Assorted Transparent Inked JUMBO Dice	\$6.00

Your own Full Figure CHARACTER

Rendered by Professional Illustrators - 8 1/2 x 11

ROLE PLAYING: SUPER HERO SCIENCE FICTION, FANTASY

FREE character description sheet. (ENCLOSE POSTAGE STAMP)

ANVIL ENTERPRISES

P.O. Box 4028
Indialantic, FL 32903



AMAZON WARRIOR™



IMAGINE YOURSELF AS THE LEADER OF A POWERFUL CLAN OF AMAZONIAN WARRIORS, SCOUTS, AND MESSENGERS. TRYING TO SURVIVE RUTHLESS ATTACKS, WATER AND FOOD SHORTAGES, EXPEDITIONS INTO UNKNOWN, UNEXPLORED TERRITORIES, AND MUCH, MUCH MORE! USE STRATEGY, GUILE AND DIPLOMACY TO WIN YOUR WAY PAST 11 OTHER PLAYERS FROM ALL OVER THE COUNTRY!

SEND \$ 2.00 FOR THE RULEBOOK, OR SEND \$ 5.00 FOR THE GAME SET-UP, WHICH INCLUDES RULEBOOK, MAP AND 187 TUNN TREES!

TURNIN: \$ 2.50 EACH. (NO CASH OR C.O.D. ORDERS, PLEASE)

FIRESTORM GAMES™
P.O. Box 1087
Taylor, MI 48180

1310 College Ave., Suite 1151, Boulder, Colorado 80302. (Add \$1 shipping)

DRAGON TREE SPELL BOOK \$7.50 (224 spells, 4 magic systems)
HANDBOOK OF TRAPS & TRICKS \$9.95 (164 non-killer traps)

DARK DREAMS

KINGRAVE

The Arduin Grimoire Vol. II

THE LAST COMMAND

The Arduin Grimoire Vol. III

By: David A. Hargrave

\$9.95 each from THE DRAGON TREE

MONSTER FILE # 1 \$6.00 (4 sheets 104-level modules)
AMAZON MUTUAL # 1 \$6.00 (4 sheets 104-level modules)

Because Fantasy is more than fighting, and Magic is never mechanical...

WHITE WOLF MAGAZINE

THIS NEW RPG MAGAZINE INCLUDES:

- SF/F SHORT STORIES
- REVIEWS, RPG ARTICLES
- GAME ADVENTURES
- AND OTHER INNOVATIVE COLUMNS

WHITE WOLF MAGAZINE IS AVAILABLE FOR ONLY \$4.50/ISSUE OR SAVE AND BUY A FOUR ISSUE SUBSCRIPTION FOR \$5. THE 1st ISSUE WILL BE AVAILABLE JULY 1.

SUBMISSIONS ARE BEING ACCEPTED: WRITE FOR DETAILS, ESPECIALLY NEEDED ARE STAFF ARTISTS. THOSE INTERESTED SHOULD SEND B&W SAMPLES.

ADVERTISERS ARE ALSO WELCOME, SEND \$10/ FULL PAGE OR \$1/ CLASSIFIED OF 50 WORDS OR LESS.

SEND TO:
WHITE WOLF PUBLISHING
119 STONECREST DR., ROCKY FACE, GA 30740

Write on!

Got a question about an article? subject you'd like us to cover — or not cover? What do you think of the magazine you're reading? Drop us a line at "Letters," P.O. Box 110, Lake Geneva WI 53147. We'll read every letter we get, and we'll select certain letters of general interest for publication — maybe even yours!

Index to advertisers

Name of firm or product	Page(s)	Name of firm or product	Page(s)
adventure Systems	29	Games Workshop U.S.	20, inside front cover
Armory, The	104, inside back cover	Iron Crown Enterprises, Inc.	1, 85, back cover
Bard Games	13	Magicware	7
Chaosium, Inc.	5	Mayfair Games	21, 23, 25, 27, 29, 31, 32-33
DBE, Inc.	22	Milton Bradley	9
DRAGON® Magazine	40, 80	Palladium Books	34, 65, 93
DUNGEON™ Adventures	78	R. Talsorian	36
Fantasy Games Unlimited	23, 26, 29, 36	Ral Partha Enterprises	37
Fantasy-Wear	87	Sky Realms Publishing	28
FASA Corp	17	Steve Jackson Games	30
Game Designers' Workshop	15, 79	Supremacy Games	25
Game Systems Inc.	22	TU-E Games	91
Gamers' Guide	94-95	Wizards Nook, The	18

Dragonmirth

"SAY, YOU DIDN'T HAPPEN TO SEE A LITTLE KID WITH A 'U' STAMP, DID YOU?"

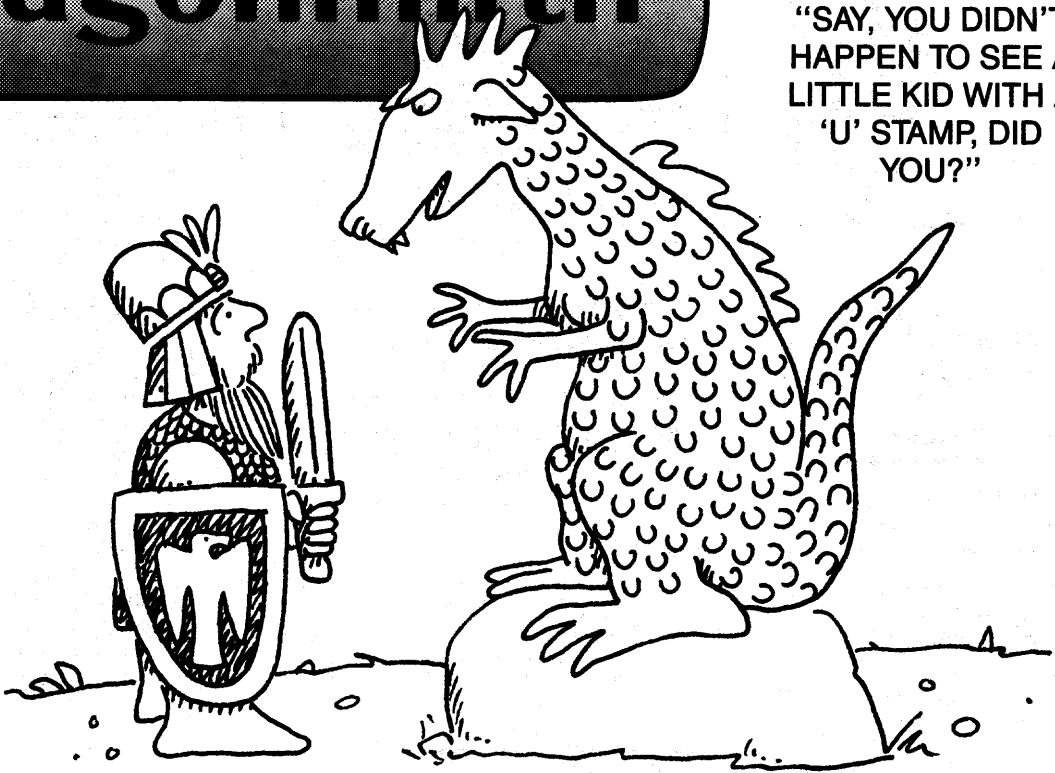

"THAT'S HIM!
THAT'S THE ONE!"

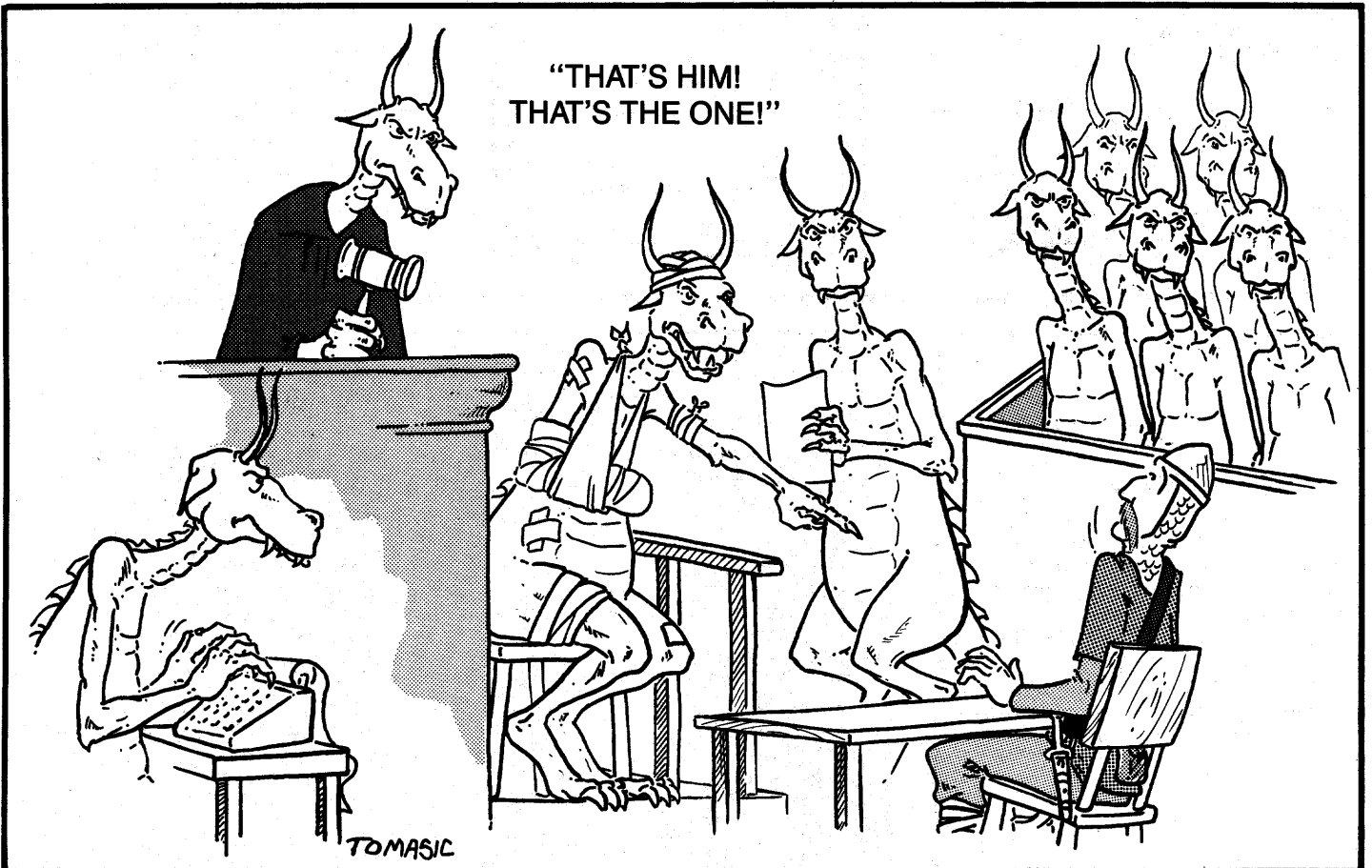

AAARGGHHH!!

**"WE'VE GOT TO HIRE OUR THIEVES
MORE CAREFULLY!"**



**"AS I UNDERSTAND IT, HIS DEITY IS VERY
STRICT ABOUT EDGED WEAPONS!"**



SNARFQUEST

37

BY ELMORE

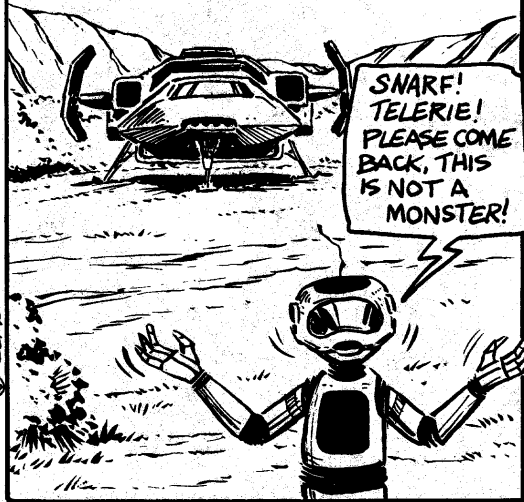

SNARF!
TELERIE!
PLEASE COME
BACK, THIS
IS NOT A
MONSTER!

MOMENTS LATER



LOOK A MAN IS COMIN'
OUT OF DA MONSTER!

AN' LOOKS LIKE
AVEEARE IS
GOIN' TO MEET
HIM!

LET'S GO
CHECK DIS
OUT!



WONDER WHAT
THEY ARE
SAYING.

I DON'T
KNOW, BUT
DEY SURE
BEEN
TALKIN'
A LONG
TIME.

HYZ'LR!
LISJWR!
LW!!

ITGLR!
LRTWPIA!



THIS ROBOT, YOU CALL AVEEARE, TOLD
ME ALL ABOUT YOUR GREAT ADVENTURES.
YOU HAVE TAKEN GOOD CARE OF
HIM. THE BLEEP SOUND THAT
YOU OFTEN HEAR COMING FROM
HIM, IS A HOMING SIGNAL,
THAT IS HOW I FOUND HIM.

DO YOU KNOW
WHAT HE IS TALKIN'
ABOUT?

NOT
REALLY. I



I ASSUME THAT BOTH OF YOU ARE
EXTREMELY CURIOUS ABOUT MY
SPACE SHIP.. IT WILL NOT HURT YOU,
YOU MAY HAVE A CLOSER LOOK.



HE CALLS THAT THING
A SHIP... CAN YOU
BELIEVE THAT?

I HOPE I CAN
REMEMBER
THE SHUT-DOWN
PROCEDURE
ON THIS 'BOT.

I DON'T
TRUST 'IM,
HE LOOKS
SLEEZY.

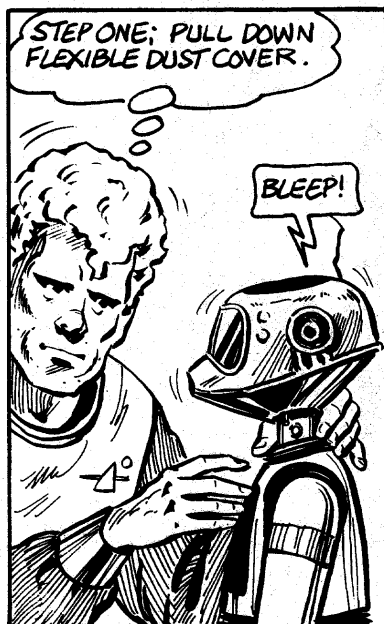

STEP ONE; PULL DOWN
FLEXIBLE DUST COVER.

BLEEP!

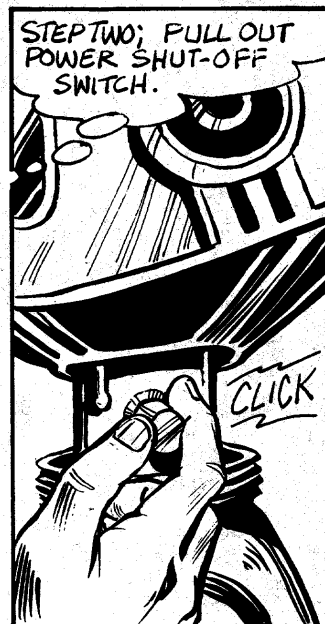

STEP TWO; PULL OUT
POWER SHUT-OFF
SWITCH.

CLICK

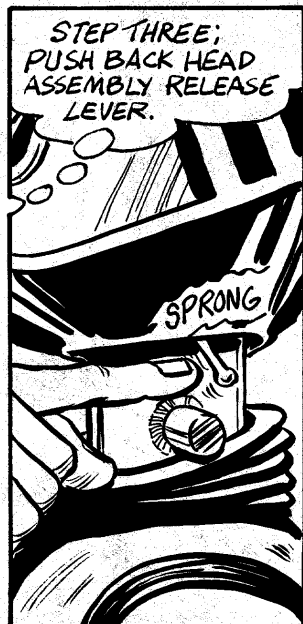

STEP THREE;
PUSH BACK HEAD
ASSEMBLY RELEASE
LEVER.

SPRONG

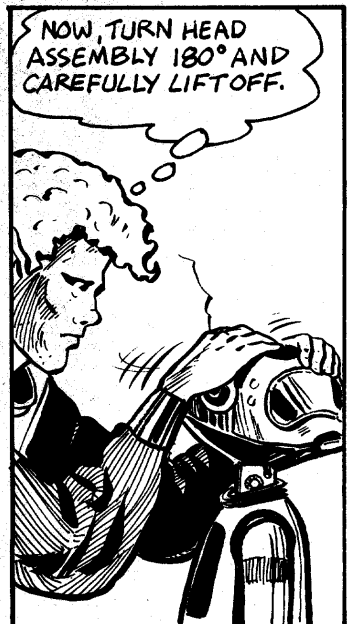

NOW, TURN HEAD
ASSEMBLY 180° AND
CAREFULLY LIFT OFF.



* REFER TO SNARFQUEST EPISODE # 17



ARE YOU TELLING ME THE TRUTH?

YEAH, DEY ARE REAL HARDY DUDES AN' DEY CAN RUN FAST... FOR DAYS, AN'... OH WOW, I HAVE A GREAT IDEA!!

LATER



SNARF, NOW THAT WE DRUG THIS KILLER OVER HERE, WHAT ARE YOU GONNA DO?

JUS' KEEP YER EYE ON DA KILLER! NOW WATCH DIS!

UUJUMMM GGUURRGG?



STAND BACK GAL — DA KILLER IS GONNA RIDE, AN' RIDE, AN' RIDE!



WATCH OUT FOR ROCKS AN' BIG TREES FOR DA NEXT COUPLE OF WEEKS! BYE-BYE!

GGULIIII!



LATER!

SNARF, THAT GRAVE FOR AVEEARE LOOKS BIG ENOUGH...

BESIDES, THAT SHIP MONSTER WORRIES ME!

OK, LET'S BURY POOR OL' AVEEARE.



WELL, WELL, I CAIN'T BURY AVEEARE WIF HIS HEAD TWISTED AROUND BACKWARDS... WOULDN'T KNOW WHICH WAY TO PLANT 'IM, ... FACE UP OR FACE DOWN.



I'LL JUS' PULL HIS COLLAR UP AN' — GEEEAH!!! DAT KILLER STUCK A METAL ROD RIGHT IN AVEEARE'S NECK, DAT'S WHAT KILLED HIM... AN' DA ROD WON'T COME OUT!



I'LL JUS' PUSH IT ON IN SO DAT I CAN GET HIS LIL' COLLAR STRAIGHT.

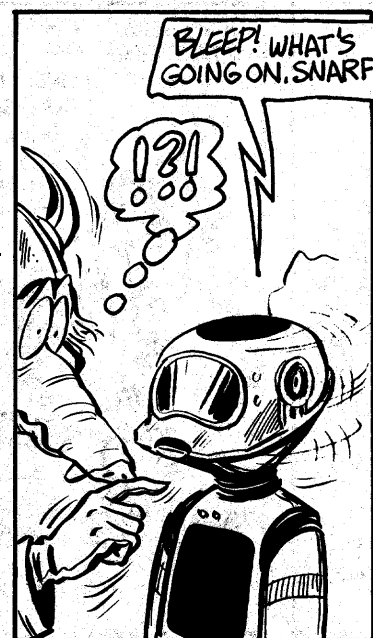

BLEEP! WHAT'S GOING ON, SNARF?



HE CAME BACK TO LIFE!!

HE'S A LIVING DEAD... OR A ZOMBIE!

WHERE IS THE MAN FROM THE SHIP?

NEXT ISSUE: THEY GO FOR A RIDE IN THE SHIP MONSTER!

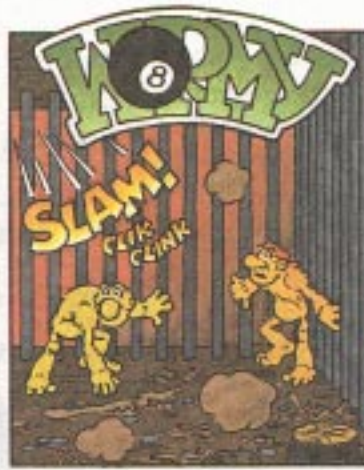



HOKAY, OKAY... GUESS I AIN'T GONNA GET NO SLEEP TILL I FILL YA IN ON THE PICTURE.

WUDDER THEY GONNA DO WIDJA?

FIRST, THAR GONNA PUT YOO INSIDE A BIG OLD SQUIR'LY-WHEEL, AND STICK A BIG CANDLE UNDERNEATH IT.

GAA! WHY?!

SO'S YA GOTTA RUN YER LITTLE BUTTS OFF TO STAY OUTA THAT FIRE!

BUT WUFFOR?

GETCHA IN SHAPE... AND TEST YER ENDURANCE.

NEX' THEY'LL MAKE YA DO SOME SCREWBALL THINGS... LIKE WALKIN' TIGHTROPES 'N JUMPIN' OVER CHASMS.

...THAT'S TO CHECK OUT YER DEXTERITY.

THIS IS STARTIN' TO SOUND VAGUELY FAMILIAR.

THEN, THAR GONNA SET YA DOWN ON A BIG TABLE-TOP, AN' GIVE YA A SWORD OR A AXE... AN' SEE HOW WELL YOO CAN HANDLE IT.

'CEPT YOO WON'T WANNA USE IT.

WHY NOT?

I THINK I KNOW

CUZ IT'LL BE AGAINST ME, OR OLD SHAGGY, OR SIZAS THAT YOOOR GONNA HAVE TO USE IT.

WHAT!!

OR EACH OTHER... OR EACH OTHER.

THAT'S HORRIBLE!!

I AIN'T GONNA DO THAT!

THE HELL YOO AIN'T!

WOO!

I'LL WARN YOO RIGHT NOW, LARRY...

I BEEN HERE LONG ENOUGH TO KNOW WHAT THESE GOONS WANT AN' I BEEN PULPED BY 'EM TOO MANY TIMES TO BE SQUEAMISH ABOUT IT ANY MORE!

...SO YOO JUS' KEEP THAT IN MIND!

BUT I DON'T GET IT, AMOS.

WHAT'S IT ALL FOR??

IT'S FOR SALE.

HUH??

THEY'RE GONNA SELL US.

SELL US!? TO WHO?

GIANTS. THAT'S HOW THESE OGRES MAKE THEIR LIVING.

AND THE GIANTS WANT US FOR...

YEP. YOO GUESSED IT, BUB...

WE'RE WANTED FOR WARGAMING.

©1986 TRAMP

ARMORY PAINTS & OTHERWORLD ARTIFACTS ARE AVAILABLE FROM THESE FINE STORES.

AL — AUBURN
Time Portal
100 N. College St. (826-0377)

AL — BIRMINGHAM
Lion & Unicorn
1915 11th Ave South (933-0777)

AL — DALEVILLE
The Book Chest
238 Daleville Ave. (598-4221)

CA — ANAHEIM
Home Front Hobbies
2880 W. Ball Rd. B4 (995-7597)

CA — BAKERSFIELD
Imagination Station
3217-B Miles St. (366-8122)

CA — FRESNO
The Game Preserve
530 E. Olive (233-4026)

CA — LONG BEACH
Balboa Game Distributors
530 W. Willow St. (424-3100)

CA — ROSEVILLE
The Puzzle Box
1000 Sunrise Ave. (781-2666)

CA — SAN RAFAEL
Ancient Dragon
1006 Lincoln Ave. (485-1943)

CA — SANTA MONICA
Aero Hobbies
1319 Santa Monica Blvd. (395-0128)

CA — W. SACRAMENTO
Flying Fortress
1229 Merkley Ave. (372-8411)

CT — W. HARTFORD
War & Pieces
7 S. Main Street (232-0608)

DE — CLAYMOUNT
Book Thrift
Tri State Mall (798-3378)

DE — NEWARK
Days of Knights
58 E. Main Str. (366-0963)

FL — HOLLY HILL
Dusty's Dungeon
1218 Ridgewood Ave. (672-9758)

FL — JACKSONVILLE
Zeno's
4525 Roosevelt Blvd (388-6241)

FL — MIAMI
Hobbyland
South Dade Shopping Ctr. (238-4387)

FL — NEPTUNE BEACH
Hobby Oasis
540 Atlantic Blvd. (249-2066)

FL — ORLANDO
Enterprise 1701
2814 Corrine Dr. (896-1704)

FL — ORLANDO
Fantasy Apothecary
1230 Boreas (273-6692)

FL — ST AUGUSTINE
Armchair General
RT. 8 Box 499 F (797-3668)

FL — TAMPA
Hans Hobby Shop
1202 W. Waters Ave. (935-7782)

GA — ATLANTA
Sword of the Phoenix
Lenox Sq. Mall (231-4244)

GA — DORAVILLE
North Atlanta Hobby Shop
5758 Buford Hwy (457-7211)

GA — MARIETTA
Complete RC Model Supply
Westside Shopping Ctr. (422-5477)

IA — DES MOINES
Fantasy Game Shop
5739 University Ave. (274-2521)

IL — BRADLEY
Castle Hobbies
246 Carriage Lane Mall (937-1920)

IL — BUFFALO GROVE
Bob's Hobby Shop
1279 W. Dundee (392-7725)

IL — SOUTH HOLLAND
Scale Models
1048 E. 162nd St. (339-3922)

IN — ELWOOD
Metalcraft Miniatures & More
1000 N. 9th Str. (552-2073)

IN — INDIANAPOLIS
Game Preserve
6101 N. Keystone (257-7116)

IN — KOKOMO
Captain Fantastic's
119 S. Main St. (457-2413)

KS — OVERLAND PARK
Kings Crown
6860 W. 105 St. (341-6619)

KS — WICHITA
Fantastic Books & Games
4815 W. 13th St. (942-5705)

KY — HOPKINSVILLE
Hobby Shop
Pennyrite Mall (886-5747)

KY — RADCLIFF
Bookstore
593 Lincoln Plaza (351-1801)

LA — BATON ROUGE
Elliot's Book Shop
3060 College Dr. (924-1060)

MA — WESTBORO
The Wiz
Westboro Shopping Ctr. (366-2030)

ME — BATH
Toy Soldier
116 Front St. (443-3711)

ME — LEWISTON
Pendragon Games
135 Main St. (784-3067)

MD — ANNAPOLIS
Skip Shop
75 Maryland Ave. (268-1141)

MD — BALTIMORE Mail Order
Gryphon Associates
PO Box 25769 Zip 21224

MD — GLEN BURNIE
Galactic Enterprises
18 N. Crain Hwy (760-9530)

MI — FLINT
Rider's Hobby Shop
3012 Corunna (234-4051)

MI — LANSING
Rider's Hobby Shop
1609 E. Michigan Ave (485-3024)

MD — JOPLIN
Parallel Worlds
2218 Main St. (781-5130)

MO — KANSAS CITY
Yankee Doodle Games
Longview Square S/C (761-1113)

MO — OVERLAND
Games, Crafts, & Hobbies
9220 Lackland Rd. (423-2199)

NC — CHARLOTTE
Dragons Nest Inc.
101 Eastway Dr. (596-9465)

NC — JACKSONVILLE
Singing Dragon Comics
103A Brynmar Rd. (577-7577)

NH — KEENE
Toy City
114 Main St. (352-3131)

NH — MANCHESTER
Game And Hobby World
The Mall Of N.H. (669-1700)

NJ — LINDEN
Kiddie Mart
515 E. Edgar Rd. (862-2435)

NJ — WHITESBORO
Pat's
K's Indoor Mart Rt. 9 (522-9426)

NY — BROCKPORT
Lift Bridge Bookshop
71 Main St. (637-8354)

NY — JOHNSON CITY
Fat Cat Books
263 Main St. (797-9111)

NY — NEW YORK
Compleat Strategist
11 E. 33rd St. (685-3880)

NY, NJ, PA, MA, VA, MD, FL
Compleat Strategist
Toll Free # 1-800-225-4344

NY — MIDDLE ISLAND
Men at Arms
RR-2 Box 7000 (924-0583)

NY — PLATTSBURGH
The Command Post
14 Brinkerhoff St. (561-5033)

NY — SYRACUSE
Twilight Books & Games
1411 N. Salina St. (471-3139)

NY — WATERTOWN
Pegasus Hobbies
121 Franklin (782-5473)

NY — WEST SENECA
Herb's Hobby Haven
1370 Union Road (674-7111)

OH — AKRON
Little Shop of War
5 Merriann Road (374-0814)

OH — DAYTON
Hobbies International
5750 Springboro Pike (299-1114)

OH — DAYTON
Black Forest Hobby
2318 E. Dorothy Rd (294-5848)

OH — KENT
Spellbinders
136 E. Main St. Suite 6 (673-2230)

OK — TULSA
OK Hobbies & Games
1312 E. 39th St. (743-9276)

OR — BEAVERTON
Tammies Hobbies
3625 S.W. Hall Blvd. (644-4335)

PA — ALLENTOWN
Jones Hobbies
930 Walnut St. (821-8828)

PA — CHAMBERSBURG
Fascinating Fantasy
153 S. Main (264-1729)

PA — LANCASTER
Park Hobbies
1264 Litz Pike (392-3987)

PA — LEBANON
Spellbound Hobbies
814 Cumberland St. (273-0567)

PA — LEMOYNE
The Magic Shop
829 J. State St. (737-7559)

PA — STROUDSBURG
The Encounter
515 Main St. (424-6132)

SC — N. CHARLESTON
Green Dragon
D-15 Charleston Sq. Mall (744-8783)

TN — CONCORD
The Yankee Peddler
10820 Kingston Pike (966-6234)

TN — MADISON
The Great Escape
Old Town Village (865-8052)

TN — NASHVILLE
The Great Escape
1925 Broadway (327-0646)

TX — AUSTIN
Kings Hobby Shop
8010 N. Lamar Blvd. (836-7388)

TX — COPPERAS COVE
Paradise Hobbies
1604 E. Highway 190

TX — CORPUS CHRISTI
Cavalier Hobbies
820 E. Waldron (937-1002)

TX — IRVING
Games N Stuff
812 Wyche (790-3651)

TX — LUBBOCK
Star Books & Comics
2014 34th St. (744-9150)

TX — McALLEN
Myth Adventures
Petite Mall (687-3104)

TX — SAN ANTONIO
Dungeon Book & Comics
3700 Fredericksburg (732-2272)

TX — SAN MARCUS
Merlins Wizardry
233 Springtown Way (353-4501)

VA — ALEXANDRIA
Little Soldier
100 S. Patrick St. (548-7357)

VA — CHARLOTTESVILLE
The Standard Bearer
8 University Shopping Dtr. (979-5545)

VA — FAIRFAX
What's Your Game
Fair Oaks Mall (591-0069)

VA — NEWPORT NEWS
CHG Inc.
9823 Jefferson Avenue (539-0151)

VA — NORFOLK
Campaign Headquarters
145 E. Little Creek Rd. (583-9451)

VA — STAUNTON
S And S Services
PO Box 2672 (885-5530)

VA — VIRGINIA BEACH
White Heron Hobby Shop
1801 London Bridge Rd. (427-2223)

WV — HARPERS FERRY
Depot Hobby Shop
High Street (535-6610)

WV — MORGANTOWN
Craigs Comics
225 Fayette St. (292-3045)

WY — SHERIDAN
Universal Travels
525 N. Main St.

CAN — SASKATOON
Wizard's Corner
801 Broadway Ave. (934-4777)

LATE ADDITIONS!

CO — ENGLEWOOD
Mile High Hobbies
701 W. Hampden Ave (762-8866)

OK — STILLWATER
Little Professor
1513 Cimarron Plaza (377-2447)

OR — PORTLAND
Military Corner
3350 NE. Sandy Blvd. (234-1881)

TX — GALVESTON
Books Etc.
1820 45th St. (762-1422)



Armory® Paint & OTHERWORLD ARTIFACTS

THE ARMORY PROUDLY INTRODUCES OTHERWORLD ARTIFACTS!

Miniature Building Accessories for 25mm Gaming & Modeling.

Over 150 Different Cast Stone Pieces & Box Sets, to Create the Castles & Dungeons of Your Imagination!

BOX SETS

BS-01	POLYGONAL WALLING, STAIRS & DOORWAYS	\$10.50
BS-02	CAVERN ROCK WALLING	\$ 7.50
BS-03	MUSHROOMS, TREES, STUMPS & TRUNKS	\$ 7.50
BS-04	6 CLASSIC COLUMNS	\$12.50
BS-05	DOUBLE GATEWAY	\$12.00
BS-06	EXPANSION WALL SET	\$14.00
BS-07	MAGICIAN'S TOWER	\$22.00
BS-08	FORTIFIED MANOR HOUSE	\$95.00
BS-09	WARRIORS WATCHTOWER	\$25.00

OPEN STOCK ACCESSORIES

- * STAIRS
- * WALLS
- * WINDOWS
- * TOWERS
- * DOORWAYS
- * STONE FLOORS
- * ROCK FORMATIONS
- * COLUMNS
- * MUSHROOMS
- * PLUS MANY MORE!



B-08 Fortified Manor House (Detail)



B-09 Warrior's Watchtower



B-08 Fortified Manor House

FOR THE FINISHING TOUCH!
THE ARMORY'S NEW

PAINTS
& BUILDING

SET PAINTS. \$10.95 each
#GG-100 & GG-101



Each Paint Set Contains
8 Acrylic Paint Colors
Unsurpassed in ease of
use, and designed
especially for painting
Dioramas, Gaming Scenes,
& OTHERWORLD
ARTIFACTS!

OTHERWORLD ARTIFACTS MANUFACTURED UNDER LICENSE BY THE DWARVEN STONECUTTER
& DISTRIBUTED EXPRESSLY BY THE ARMORY.

Adventure beckons... come to MIDDLE-EARTH®

with Fantasy Role Playing products from
IRON CROWN ENTERPRISES

MIDDLE-EARTH ROLE PLAYING™ (MERP) is perfect for seasoned gamers looking for a realistic, easy-to-play system. MERP works equally well for those who have never experienced the thrill of Fantasy Role Playing. Designed with faithful attention to Tolkien's world, MERP provides rules covering combat, magic, professions, and everything necessary for adventuring in the greatest fantasy world of all time!

Copyright © 1986 TOLKIEN ENTERPRISES. THE HOBBIT™ & THE LORD OF THE RINGS™ and all characters and places therein are trademark properties of TOLKIEN ENTERPRISES.

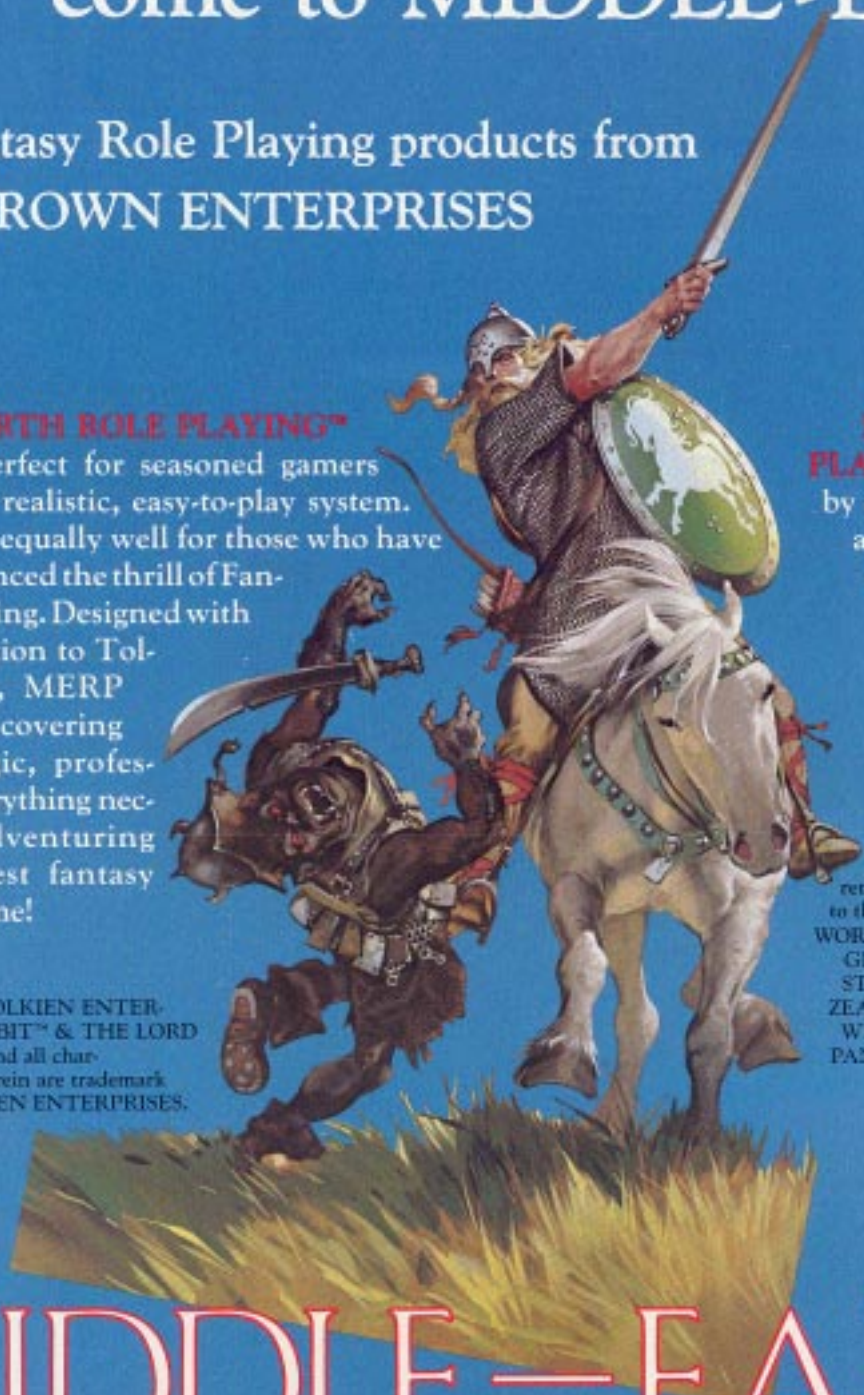

MIDDLE-EARTH ROLE PLAYING™ is well supported by a wide variety of aids and adventures. Look for these products wherever games are sold!

These excellent products are sold at retail outlets worldwide. Sold exclusively to the hobby trade in the UK by GAMES WORKSHOP, in SCANDINAVIA by TARGET GAMES AB of Stockholm, in AUSTRALIA by JEDKO GAMES, in NEW ZEALAND by BLACKWOOD GAYLE, in WEST GERMANY by CITADEL, in JAPAN by POST HOBBY CO., LTD. and in ITALY by PACIFIC ENTERPRISE ITALIA.

MIDDLE-EARTH ROLE PLAYING™

...A WORLD APART



PRODUCED & DISTRIBUTED BY IRON CROWN ENTERPRISES / P.O. BOX 1605 / CHARLOTTESVILLE, VA 22902