

Grimtooth's *TRAPS*

a game-master's aid for
all role-playing systems

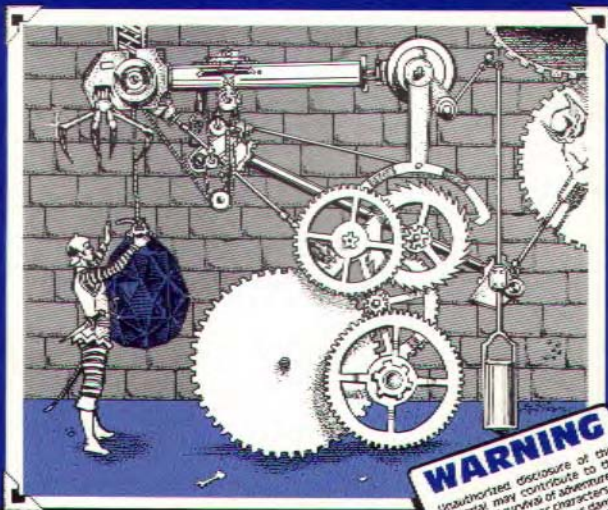

101 traps for use with
any role-playing system

#8501

Produced by Flying Buffalo Inc.

WARNING

Unauthorized disclosure of this material may contribute to the undesired survival of adventurers and may result in serious damage to the deadly reputation of the Game Master.



All-System
**Analyst
Series**

Grimtooth's *TRAPS*

**a game-master's aid for
all role-playing systems**

*a compendium of catastrophic traps
sinister snares, engines of evil, and deadly devices
with passing comments made on a folio of fearful fates
in all, one hundred and one ways to influence
adventurers, delvers, tunnellers, and all player characters . . .*

edited by Paul Ryan O'Connor

illustrated by Steven S. Crompton

Produced by



a division of Flying Buffalo Inc.

PRODUCED BY

TM



A DIVISION OF FLYING BUFFALO INC.

ATTENTION

The traps in this booklet are designed for game purposes only. Actual construction of these traps might prove harmful, and such construction is strongly discouraged.

Copyright © 1981 by Flying Buffalo Inc.

No part of this book may be reproduced or transmitted in any form or by any means, electronic or mechanical, including photocopying, recording, or computerization, or by any information storage and retrieval system, without permission in writing from the publisher, BLADE, P.O. Box 1210, Scottsdale, Arizona 85252-1210

ISBN 0-940244-75-6

Table of Contents

A Word From Grimtooth	page v	Supercharger Crawlway	24
And Now, A Word From The Editor	page vi	The B-B Slope	25
Chapter 1. Room Traps	page 1	The Rolling Stone	26
Infamous Wheel Trap	2	CO ² Delver Extinguisher	26
Roman Amphitheatre Trap	3	Von Hindenburg Chamber	26
Illusions	4	The Avenging Treadmill	26
Slider Spiker	4	Air Thee Well	27
Lobster Trap	5	<i>Step and Die</i>	
The Deluxe Centerpost	7	The Smashing Floor Trap	28
The Dastardly Lava Room	7	Whirling Blade Boot Bloodier	28
Hoovermatic Trap	7	First Step Trap	28
The Bigger They Are	7	Crossbow Thirteen	29
Is It the Piccolo, or Is It Memorex?	8	Stair Snare	29
The One That Got Away	8	Hero Sandwich	30
The Atlas Affair	9	The Piano Floor	30
The Bridge at Rue Vincent	10	The Flesh Pot	30
Chapter 2. Corridor Traps	page 11	Chapter 3. Door Traps	page 31
<i>Obstructions</i>		The Circular Doorway	32
Hop, Skip, and a Jump	12	Giant's Razor	32
The Gas Passage	13	The Guillotine Door Trap	32
Sectioning Corridor	13	Poison Door	33
Archer's Tunnel	13	Cure A Kicker Trap	33
Mirror, Mirror, and the Fall	14	Dry-Rot Door	34
Magnificent Marble Misadventure	15	Dragging Doorway	34
Trip Wire That Isn't	16	Double Door Doom	34
Last Laugh Trap	16	Delvermatic Dicer and Malingerer Trap	35
Take a Deep Breath	17	Chapter 4. Items and Artifacts	page 37
Look Before You Leap	17	The Hot Rocks	38
Between A Rock and A Hard Place	17	Nefarious Nymph Statuette	38
The Greystoke Memorial	18	Magnesium Torch	38
Ball Bearing Corridor	19	Spy Glass	39
The Slippery Pit	19	Moviola	39
<i>Detours</i>		Theft-Proof Gem	40
Which Way to the Front?	20	Jerk With The Box	40
Chute and Hammer Trap	21	Stuffed Raccoon	40
Orfile's Slide of Delver Dumping	21	Rope Serpent	41
Mapper Maddener	22	Speak Down	41
<i>Murderers</i>		Lightning Gem	42
Pilum Pacifier	23	Idiot's Vase	42
Folly Flight	23	Satan's Bow	42
See-Saw Corridor	24	Cup of Golden Mead	43
		The War of the Ring Trap	43

Table of Contents (continued)

<i>Item Traps (continued)</i>	
Have A Ball	43
Vincent Van Gogh Seashell	43
Here Doggie!	44
A Cask of Immolation	44
Gauntlets of Doom	44
Turn-About Is Fair Play	44
Well Blow Me Down!	45
Bury the Hatchet	45
Achilles' Shield	45
Cape of Dorian Grey	45
The Acid Test Scabbard	45
Iron Maiden Helmet	46
The Morningstar Supernova	46
Double-Crossbow	46
Atomic Necklace	46
Chapter 5. Things	page 47
Sword Breaker	48
Eye-Catching Trap	48
Wall Wards	49
Fountain Trap	49
Floor Creature	49
Going Down?	50
Ariadne's Revenge	50
Four on the Floor	50
Various Killers of Paranoids	51
A Hot Time In The Old Camp Tonight	52
The Cranequin Goose	52
The 101st Trap	page 53
List of Contributors	page 54



A Word From Grimtooth

Greetings, and welcome to my book of Traps. Assembled herein are one hundred and one of my favorite traps, gathered from the four corners of the earth, and presented for your approval. These traps are the work of a host of distinguished contributors – each a dungeonmaster extraordinaire. In short, I feel that you'll find this to be the most entertaining collection of traps you've ever laid eyes on.

Besides, if you don't like my book, I'll rip your lungs out.

I have organized this volume of traps into easy-to-distinguish chapters. This will better facilitate inserting them into your own pits and tunnels. With each trap, I've provided only the basic mechanics – it's up to you to fill in the blanks as to how much damage or what level saving roll seems appropriate for each device. (Hence the generous "Notes" column I've provided on each page. Pencil in your reactions there.)

To give you a general gauge by which to determine approximately how destructive a trap is, I've assigned to each trap a "Deadliness Rating": a series of skulls printed near the trap in question. The more skulls you see, the deadlier the trap. You will find that the traps in this book will range from causing broken fingers and wounded egos to forcing almost certain death.

Also note that you can increase or decrease the "punch" of a given trap by simply altering its consequences. This will, of course, depend entirely upon your mood and circumstances. By filling a pit with an obnoxious-smelling green dye instead of boiling oil, you have essentially altered the entire trap – yet the delivery system remains the same. With a modicum of monkeying around, you should be able to make any of the traps in this book leap through hoops for the edification and bemusement of delvers who journey through your dungeons.

Then again, my traps are perfect as is. You'd have to be some sort of pinhead to want to change them.

Thus, without further ado, I hereby present my book of traps. Enjoy it or die, mortal.

– Grimtooth

And Now, A Word From The Editor

Editing Grimtooth has been an experience in the pleasure of pain. Before seeing Grimtooth's manuscript, I would have never believed that there are so many ways to ensnare, humiliate, redirect or otherwise destroy your average dungeon-delving slob. But ways there are indeed, and their number is uncountable.

Uncountable because this book really only scratches the surface. For every trap printed in this book, there were two that were left out. For every trap that appears here I could develop at least five variations, each of which could be called a different trap in and of itself. Each variation spawns a series of sub-variations, and so on.

I've tried to present Grimtooth's best stuff here. Indeed, my job as that learned troll's editor was really one of organization more than anything else. Most of the creative (or destructive) work had already been done by Grimtooth and his contributors long before the manuscript for *TRAPS* ever reached my desk. Still, many of the traps presented in this book have seen substantial change and reworking since they were originally submitted. I apologize in advance for any displeasure this may cause to the original contributors, but I assure you that any changes made were ones necessary to preserve the overall format of the book. Besides, most of the changes were made by Grimtooth, and I refuse to be held accountable for his decisions.

In any event, I've always felt that the best editorial forwards were those that ended quickly, so I hereby pass you on to the bulk of the book before you. I can only hope that reading this book of traps will give you as much pleasure as it did me. Enjoy.

— Paul Ryan O'Connor



1

Room Traps

The room trap is probably the most feared type of dungeon doom device. It is the main event, the central attraction, the carefully-planned and patterned engine of destruction geared solely towards the destruction of those who venture within. No mere hallway nuisance or dangerous treasure are these – room traps are thoroughbred delivery systems of dismay, designed only to kill.

By their nature, room traps are often the most contrived and detailed of traps. They are also often the most fun to employ. Delves, too, seem to enjoy room traps far more than any other variety – such traps often present “puzzle boxes” for the characters to strain their infinitesimal brains over, while you move in to smash them with a club. A good time is thus guaranteed for all.

Use these traps carefully. An overabundance of room traps can slow your pacing to a crawl, and will disrupt the characters’ interest in continuing the adventure. When used correctly, however, room traps can provide the finest of challenges.

Room Traps

– NOTES –



To begin this chapter, I present the **Infamous Wheel Trap**, designed by Paul O'Connor. You can put this trap just about anywhere you have a lot of room, although it works best when it is sprung upon a large number of delvers all at once – such as at a dungeon entrance.

The trap design is rather complex. The delvers walk through a door to find that they are standing at the base of a long ramp. The incline slopes up away from them and ends in a wall with a door in it. A 5' trench is dug down the direct center of the incline, and runs from the base of the slope to disappear beneath the door. The ceiling over the main-corridor part of this trap is quite high.

To the right and left of the delvers, as they stand at the base of the incline, are two small, featureless rooms. Entrance to these rooms is blocked by several rows of sealed barrels, arranged so as to stand partially into the main corridor. Upon inspection, these barrels will prove to be filled with a liquid of some sort (determined by the sloshing sound when they are nudged) – but the containers will also prove to be both unopenable and completely immobile. Delvers will find that with a bit of effort they can scurry over the tops of these barrels and into the rooms beyond.

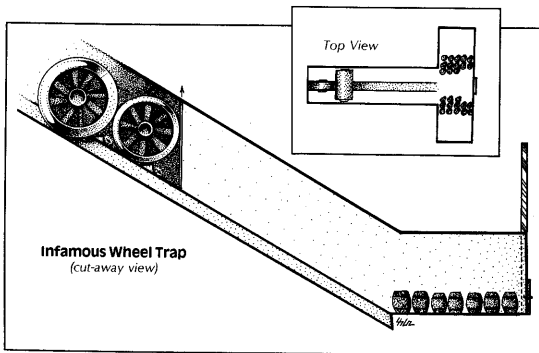

The trap is activated when a member of the party actively starts up the slope. At this time, a steel curtain will slide down from the ceiling to block the doorway through which the delvers entered. At the same moment, the large wall up the corridor will drop into the floor, revealing a large, black, corridor-sized wheel. No longer restrained, the wheel begins to roll down the slope, towards the party, at an amazing speed!

The wheel reeks of strong anti-magic, and is indestructible. Thus, the party's options for evasion are limited to the less destructive methods. They can scramble over the barrels into the small rooms before the wheel reaches them; or they may attempt to leap into the trench running up the corridor, hunker down, and allow the wheel to pass by them overhead.

The methods you employ to determine whether or not a character escapes

the wheel will vary, of course, but I suggest you make the required rolls tougher and tougher as each character completes his or her evasive maneuvers. This will ensure that those who think and act fastest will have the greatest chance of survival. If you choose to be especially fiendish, you might rule that if a character fails to clear the barrels or make the trench, he or she blocks off the characters behind from attempting that path . . .

The fun is just beginning. The large wheel will pass over the characters in the trench (unless they're giants, or something equally absurd) – but those characters will be horrified to see that there's a *second* wheel, every bit as deadly as the first, rolling down the *trench* just a few feet behind the first wheel. The only way to escape the wheel is to leap back out of the trench – something that should prove considerably tougher than simply jumping in.

The characters that escaped the wheel(s) by rushing into the side rooms aren't out of the woods yet, either. The barrels of liquid mentioned before are intended as crash-cushions to prevent the wheel from doing horrible, tell-tale damage to the back wall of the room. These barrels will collapse scientifically, slowing the wheel just enough so it will still crush any character caught behind it, but won't do any major structural damage. The barrels, however, aren't filled with water or foam – they've been filled with a burning, corrosive acid!

The acid will spray into the side rooms, almost certainly covering the characters standing within. Armor will provide a certain amount of protection, but only at the expense of its future effectiveness – this acid is *corrosive!*

Getting the characters back into the flow of the dungeon after the destruction has ceased might prove a bit of a problem. You could design the room so that the splashing acid burned away the top layer of plaster within the small rooms, revealing a number of secret doors. Or, you might place a door at the top of the incline, beyond where the wheels were originally located. Suit yourself.

Another trap that hurls lethal objects at the unsuspecting party is the **Roman Amphitheatre Trap**, designed by Betty Kopf. This trap is a rather obvious one, but it's great for visual effects, and it will almost certainly be triggered due to the treasure it offers.

The amphitheatre itself is dominated by a crouching statue that bears a huge

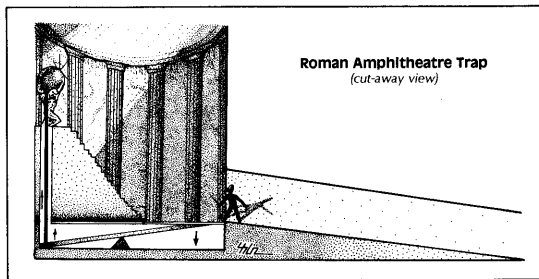

golden globe upon its shoulders. The globe is roughly 5' in diameter, weighs in the neighborhood of 5 tons, and is worth approximately 50,000 g.p.

The amphitheatre's floor is actually an enormous, finely-balanced lever. Whenever a weight is set upon the floor (such as a dungeon party), the lever will shift, causing the pole within the main amphitheatre structure to rise and dislodge the golden sphere. The ball will bounce down the steps and into the midst of the party.

The globe itself makes quite a prize, but getting it out of the dungeon will prove a problem. Reducing the globe to a more manageable size would ruin the quality of the sphere, and would drastically reduce its value.

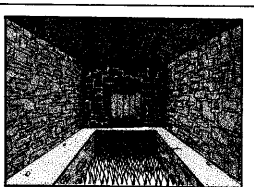

Fig. A (trap as it appears)

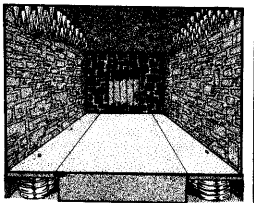

Fig. B (trap as it truly is)

Illusions, a fatally subtle room trap, was designed by Pat Mueller. The trap presents the delvers with a room, the center of which is occupied by a spike-filled pit. The only way around the pit appears to be walkways to either side of the spikes. (See Figure A.)

The visible pit is an illusion. Also an illusion is the section of roof above the walkways, which in reality is covered with rows of spikes not unlike those in the pit. (See Figure B.)

The safe way through this room is to walk across the "pit". Using the walkways will cause the springs beneath the floor to slam those sections against the ceiling. Ouch.

Not content with his "Infamous Wheel Trap" design, Paul O'Connor has developed two more room traps. Both are absurdly complex, and go to great lengths to dispose of characters in incredibly bizarre ways. Every now and then, when confronted with the fiendish workings of his mind, I begin to suspect that Mr. O'Connor is a distant relative of mine . . .



For example, consider the **Slider Spiker** trap, which I might have designed myself! The trap takes the form of a room with a staircase in it. This staircase runs up about thirty feet and ends in a door. The only other features noticeable in the room are a hole in the ceiling and, directly beneath it, a thin parchment target which conceals a long, sinister steel spike.

When a person climbs the stairs and touches the door, the steps of the stairs fold down, and the stairway converts into a slide. Unless the delver can somehow stop himself, he'll slide down the length of the stair to vanish into a hidden trap door at its base. The trap door will snap shut, and the character's screams will be heard receding into the depths . . .

... until they're heard again from the ceiling. At the bottom of the trap door pit is a teleporter pad, which transports anything that hits it to the hole in the ceiling above the target. The character in question thus falls through the floor, then completes his journey by falling out of the ceiling, through the target, and onto the spike.

A usually fatal trap. Also, an incredibly confusing one.

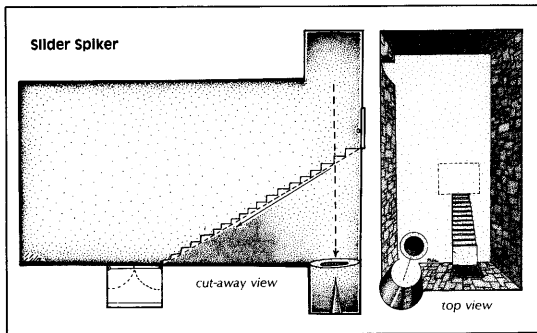

An even stranger room trap from Paul is the **Lobster Trap**, designed for characters who have been captured and rendered unconscious elsewhere in the dungeon. When those characters come to, they find themselves in a rather precarious position.

The delvers are being held captive in a cage suspended fifty feet above the sandy floor of a large, circular room. Hungry rock lobsters prowl the room, menacingly clacking their claws in anticipation of the feast to come. The cage itself hangs by a chain from a winch. The winch is fixed into a track that runs across the room's ceiling to terminate in a blank wall some distance away.

The cage itself has two trap doors, both easily visible and unlocked. The trap door above opens onto the roof of the cage. Characters may move freely about on the cage roof, where they'll note that the winch device is equipped with two ring-like handholds.

There is more to this situation than meets the eye. First, the cage projects an undetectable invisible-wall spell from the cage's bottom all the way to the floor. This will allow the characters to climb down the rope ladder safely, as the lobsters cannot breach the wall – but don't tell the delvers that! Second, the wall section in which the ceiling track terminates is, in reality, a thin section of painted parchment – the track continues straight on through. Finally, a hidden hollow in the floor below the cage's original position contains a treasure chest and an unmarked lever set into the ground.



Room Traps

– NOTES –

The lobsters are tough, and direct combat with them would probably end in disaster for the characters – they're intentionally set up as an unbeatable menace, and the characters awoke in the cage completely unarmed! Their possessions are held in a small room beyond the only door out of this complex.

The delvers cannot simply kill the lobsters to escape. A single character must crawl on top of the cage and pull on the handhold rings with all his might. This will drain from the character some predetermined amount of strength, causing the cage to slide along the track in the ceiling and then drop. If the character is strong enough to fulfill the winch's requirements, then the cage will move through the false wall section to fall into the bed of feathers beyond. If the character in question lacks the required strength, then the cage will move a considerably shorter distance before falling – this time down to the lobsters below. Too bad.

Should the characters be fearless, and decide to climb down the rope ladder, they will almost certainly notice that the lobsters keep a respectable distance from the shield, and will probably thus learn of its existence. Any character who reaches the floor of the room will probably find the secret hollow.

The hollow contains a chest full of treasure – plentiful or poor, depending on the GM's whim. Beside the chest is a lever, the function of which is indiscernible.

Lever lead to doom for dungeon delvers. Pulling the lever immediately, irrevocably, cancels the invisible-wall spell projected by the cage. The lobsters, being sensitive to such things, will rush in greedily for the kill.

As previously noted, the characters' possessions await them in the room just off the chamber full of feathers. If you feel really mean, booby-trap them.

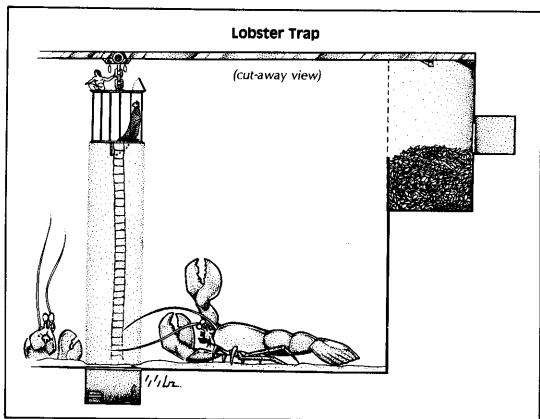

The Deluxe Centerpost by Rick Loomis is a much simpler trap. In the center of a simple square room, a single, indestructible deluxe magic staff is wedged betwixt floor and ceiling. The staff, a coveted prize, supports the ceiling: a free-standing 10,000-lb. block of granite. Aside from this handicap, the staff is free for the taking.



The Dastardly Lava Room, by Scot Rhoads, is another elegantly simple trap. Delvers encounter it when they enter a standard dungeon room that contains several mounds of glowing (and imperceptibly growing) lava. Regular exits through standard doors are easily accessible from any point in the room.



A medium-sized tunnel leads from this room; at the end of this tunnel the delvers can clearly see a sign. Exactly *what* the sign says, however, is indistinguishable.

A character who journeys down the tunnel to see what the sign says will be greeted with the inscription, "You Blew It". When the character turns around, he'll see that the lava mounds have moved behind him to block the tunnel entrance, leaving him hopelessly trapped.

The devious dwarvish mind of Todd Diesen was responsible for the **Hoovermatic Trap**, which takes great pains to prove the effects of a partial vacuum upon dungeon delvers.



The delvers enter this room through its only door, which will slide noiselessly shut and lock behind them once the last party member is inside the room. The door fits flush into the wall and will be very difficult to rediscover.

The room itself is lit by a strobe light. The floor is 3' deep in gold coins. The walls are made of black basalt, smooth and featureless; the ceiling is difficult to see, due to the lighting.

As the delvers greedily pack up the riches, the ceiling will begin to pull away from the floor. This causes the room pressure to change, making the air incredibly thin. After six to eight minutes of this treatment, characters will probably begin to faint.

After ten minutes, the air will be thin enough to kill the unconscious characters. Sputtering torches or lamps, the fainting of small animals the delvers might have brought along, a feeling of pressure in the ears, or the fact that characters are dropping dead right and left will probably tip off the characters. Those who fall unconscious under these conditions will bleed from the nose.

If the trapped characters realize what's going on, they would be well advised to search for the door they entered through. If they appeal to the Gods for something to breathe, feel free to fill the room with poison gas . . .

Mike Stackpole has developed a room trap he calls **The Bigger They Are**. Once again in his infinite generosity Mike has subjected delvers to another form of cliché doom.



Delvers encounter the trap when they enter a large natural cavern. The entrance is quickly sealed behind them – by door, falling rocks, or what-have-you.

Room Traps

– NOTES –

At the same time, the room begins to fill with water.

Somewhere near the ceiling, overhanging a ledge, is a large rock doing a credible imitation of a piton. Some smart delver will probably try to loop a rope around this rock so as to climb to safety – especially if you introduce sharks or similar nasties into the water.

The rock, however, is delicately balanced in place. Any sort of tugging upon it will cause the rock to drop – usually onto the heads of the party trying to rope it. In any event, the rock will fall – and the bigger it is, the harder the fall.

This watery room trap, submitted by Brandon Corey, is jokingly titled, **Is it the Piccolo, or Is it Memorex?** It provides several levels of danger with an interesting visual effect thrown in for free.

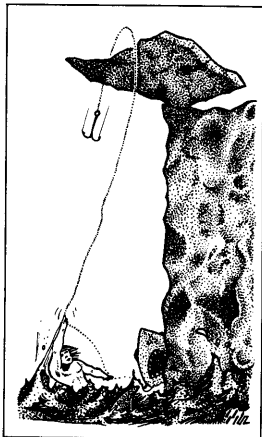

The trap takes the form of a glassy-walled room, obviously located deep within some body of water. Large and ponderous sea creatures float by in the murky gloom visible beyond the glass. The effect is breathtaking.

Within the room, set upon an elaborate pedestal, is a beautiful bejewelled piccolo. Guarding this treasure, however, is a shambling shoggoth, as described in the works of H.P. Lovecraft.

When confronted with this situation, most characters will attempt to play the piccolo, and thus exploit the shoggoth's well-known weakness for the sounds of the same. Sure enough, the shoggoth will lurch into a ponderous dance; the shriller and higher the note from the piccolo, the less dangerous the shoggoth will be.

The real trap here, however, is the fact that the glass walls of this room are sensitive to certain pitches which an unlucky piccolo player might very well sound while entertaining the shoggoth. When such a pitch is played, the glass walls will shatter, admitting several tons of seawater into the room . . .

A truly absurd room trap is **The One That Got Away**, by Michael Austin. This trap goes to such incredible lengths to be silly that I really had no choice but to include it here.

The room is formed from natural rock, complete with an array of menacing stalactites hanging from the ceiling. Most of the floor area is covered by a freshwater lake. Set out some distance onto this lake is a pier of sorts, upon



which stands a fisherman's chair, complete with pole. The water below is patrolled by numerous hungry – and deadly – fish. There is already some tension on the fishing line, which disappears into the water below.

The chair is set upon a spring-loaded shaft; the spring will release when the fishing line becomes taut. Thus, when a character seats himself upon the chair and begins to reel in the line, the trap is (quite literally) “sprung”.

The chair is thus hurled high, sending the character flying. If the character releases his grip on the fishing pole, his trajectory will intersect with one of the ceiling's stalactites with a resounding splat. If the character hangs onto the pole for dear life, he'll easily clear the ceiling – and land upon a hidden reef located just inches beneath the surface of the water.

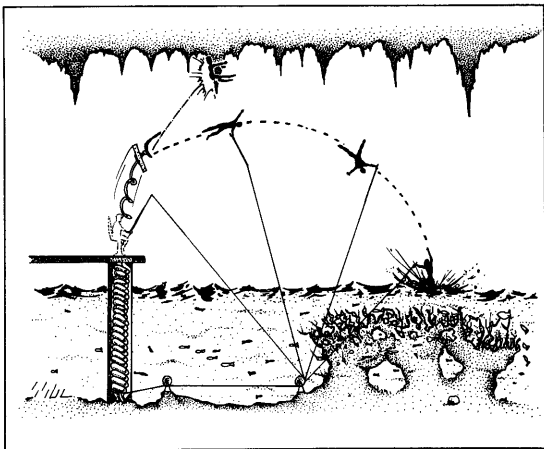

Michael Austin has developed a pair of strange room traps. Each is designed to deal with unnecessarily violent and/or greedy characters.

The Atlas Affair is a room filled with exquisite Greek statues. Each statue is mounted upon a turntable that slowly spins to show the statue from a variety of angles. To enhance the beauty of the statues – and thus ensure the delver's doom – a valuable gem has been set into the base of each figure.



Each statue is protected by a cylindrical magical barrier that runs from floor to ceiling. In addition to protecting the statue, the cylinders also serve to hold up the roof. Thus, if the delvers choose to loot the room by dispelling the magical cylinders, they will end up bringing the roof down upon their heads, with the appropriate effects.

Room Traps

– NOTES –



The Bridge At Rue Vincent is Michael's second strange room trap. The trap is a room filled to a depth of ten feet with boiling wax. A narrow wooden bridge lacking guardrails and the usual safety items crosses the wax. The air is laden with vapors from the boiling wax below; the wax has splashed up upon the bridge, making it quite slippery. Guarding the bridge is a magical statue of living flint.

The characters should be able to smell the wax in the air, and feel it on the bridge and on their armor. A fall into the wax below is quite likely to be fatal – if the fall doesn't kill the character outright, being suffocated in boiling wax probably will.

The flint statue is the crux of this trap. If the statue is attacked with steel weapons, the flint should send up a shower of sparks. With a bit of luck, the wax vapor will ignite, setting fire to the bridge – and probably to a number of the characters as well.

2

Corridor Traps

A long, dark, damp dungeon corridor is probably the most common setting for a trap. Ceilings can fall in, walls can drop down, arrows can fly from hidden ports – a corridor is really one of the most dangerous places to be within a dungeon, despite its usually innocent appearance.

One of the main reasons traps work so well in corridors is the fact that, due to the tunnel's dimensions, you have a fairly good idea where the party will be walking, and can thus plan your horrible devices with a high degree of directional accuracy. Where else can you expect your victims to line up in a neat little row like a sequence of pop-up targets?

The traps in this chapter are intended to be used primarily within corridors and stairwells, but with a little modification you could just as easily work them into standard rooms or treasure chambers. Some of these traps will serve well to forcefully change the delvers' line of advance; others will ensnare; others will merely kill. But all of them will ensure that the delvers in your dungeon proceed down the tunnels with the utmost caution.

No running in the halls!

Obstructions

A popular form of corridor trap is the variety that obstructs or otherwise impedes the party's path of travel. Traps such as these can usually be overcome with sufficient effort and brain-strain, but the consequences for failure are often fatal. Due to their nature, traps such as these function well when placed athwart the route to a treasure chamber or an exit from the dungeon.

Rivers of acid, water, or molten lava crossing a tunnel are natural corridor obstruction traps. Such things are fairly common in the delving world, however, and most experienced adventurers will greet such obstacles with a yawn. They've probably seen this sort of thing hundreds of times before, and will doubtless navigate the obstruction in some tried and true way.



It was with this line of reasoning in mind that Barry Sullivan developed the **Hop, Skip, and a Jump** trap. The construction is simple. Present the party with a typical trench perhaps four or five feet across and filled with some disagreeable substance. Tell them that they could probably jump across the pit with a certain amount of effort, but that falling into the substance would be fatal. Do *not* tell them that an invisible wall stands on the opposite side of the pit!

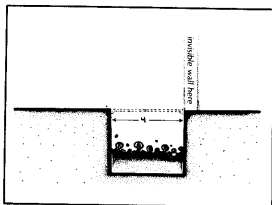

The first character to attempt the jump is almost certainly doomed. The invisible wall presents nothing to grab onto, and the incident will probably happen so quickly that the remaining party members won't have a chance to save the character before he splashes into the pit. The only way to defeat this trap is to dis-spell the wall and then jump, or to teleport across to a spot beyond the wall.

If you think this trap is a bit too deadly, there are a number of variations which can be applied. For instance, you can put up a sheet of heavy glass in place of the invisible wall. This removes all magic from the trap, thus eliminating the chance of a magic-user sensing that there's something on the other side of the pit. Also, if the character who jumps the pit is especially lucky, he might travel through the glass instead of simply bouncing off it. The delver would take a significant amount of damage from plunging through the glass, but he'd still be in better shape than if he'd fallen into the lava.

If you want to make the trap a bit more insidious (and those nasty delvers certainly deserve whatever abuse you can dish out upon them), then you can cover the pit with a trap door designed to give way when a delver treads upon it. Thus, the same pit might get two delvers — the first when the lead character falls in the pit, and the second when the remaining party members attempt to jump over the trench.

An equally subtle and deadly corridor obstruction was submitted by Scot Rhoads. The trap is called **The Gas Passage**, and is designed especially to extinguish torches and perhaps even kill the unwary or the stupid.

Confront the party with a lowered section of corridor filled with carbon dioxide. This will serve to put out the torches of passing parties, and will eventually kill any character foolish enough to stand around in the tunnel (you may wish to tempt the party with a few hints about secret doors to get a character to do just that).

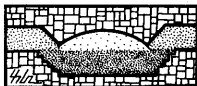

To make this trap even more deadly, you might experiment with placing a pocket of natural gas or hydrogen above the carbon dioxide in the lowered section of corridor. This could cause explosive consequences for those delvers who try to circumvent this trap by holding their torches above the CO² as they pass through the corridor.

Delvers often seek safety in numbers. They walk close together, fight back-to-back, and navigate dangerous locations while roped to one another in a line. Some of the most interesting combats, however, are those which match the delvers singly against one or more monsters.

To set up such situations, Rick Loomis developed the **Sectioning Corridor**. The trap is triggered by a pressure plate concealed within the floor of the corridor. When this plate is stepped upon, the walls of the corridor swiftly turn perpendicular to themselves, isolating each member of the party in a separate section. You can release monsters into the opened sections, creating some interesting combat situations.

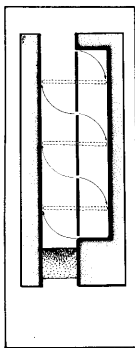

If delvers are walking side by side when this trap activates, they will probably wind up in the same section together. You can allow this if you're the sort who likes to give delvers a break. Then again, if you're properly fiendish, you might consider narrowing the corridor to a width of five feet, ensuring that you'll catch the party in single-file formation. In any event, be sure to provide a means of resetting the trap, allowing the corridor to form up again and provide a way for the party to continue their journey.

A corridor obstruction trap with a twist was provided by Charles Scott Kimball, who devised the **Archer's Tunnel** to put some interest back into vertical ladder chambers.



The trap was originally designed for a dungeon with three or more levels, and probably works best when the party comes upon it from the middle level. The structure of the trap is composed of a ladder shaft, complete with a pit or

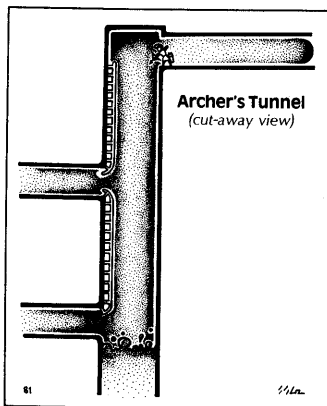

boiling lava (or some other horrible substance) at its bottom. The ladders may be sturdy, or only loosely-attached, depending upon how malevolent you feel.

At the top of the shaft stands an archer, his weapon ready. You can determine his stats to best suit your needs, but make him fairly accurate. The archer will shoot at anyone climbing up the ladder (or flying up the chute). Needless to say, the party will find themselves in a rather sticky situation — especially if the archer waits until they are midway between levels before shooting, so as to strand his

targets between routes to safety. Hard-pressed to retain their grip upon an possibly unstable ladder, the party will doubtless find it hard to return fire or undertake extensive spell-casting in their defense.

Use this trap to give characters a hard time if they try to return to the upper levels of your dungeon with intent to escape. The lower level exits from the shaft, of course, lead to the deeper (and thus more dangerous) regions of the dungeon.



A truly clever trap, **Mirror, Mirror, and the Fall**, was designed by Maughn Matsuoka. This trap uses an evil system of mirrors to lure characters to their doom.

The delvers are presented with a room, 50' long from doorway to doorway. The area between the doorways is filled with molten gold. The delvers must find a way to cross the gold before they can continue their journey.

Halfway through the narrows is an invisible wall. The wall should present an added obstacle to the party's progress, and will also provide protection for the mirror further along.

Farther down the corridor, a mirror crosses the corridor diagonally. The mirror reflects the left wing of the room in such a way that it appears to be a

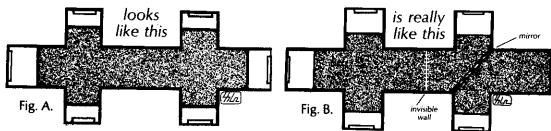

continuation of the main passage, instead of a side passage. Beyond the mirror, for an additional ten or fifteen feet, is a further expanse of molten gold.

The fact that the corridor appears so short may encourage some to attempt to teleport across. Doing so, however, will almost certainly land the magicker in the gold. The party at the other end of the room will see the mage vanish, then hear him scream, but they won't know what has happened to him.

When the delvers figure out what's going on, and breach the wall and break the mirror, you might want to surprise them with some troops in the right wing of the passage. Such troops could make it quite sticky for delvers who attempt to make it to the left wing and the door therein.

David McConnell submitted a particularly vicious obstruction trap. Called the **Magnificent Marble Misadventure** by its creator, this trap is sure to slow even the most confident party to a crawl.

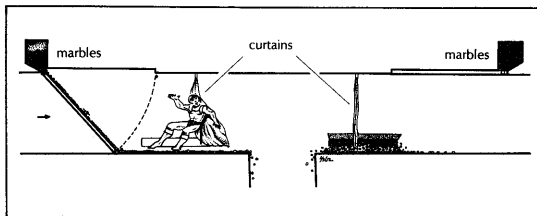

The trap is first encountered as a simple, unadorned set of curtains hanging across the dungeon corridor. When these curtains are disturbed or parted, a large door swings down from the ceiling behind the party, releasing a supply of oil-coated marbles onto the floor. The characters will probably have a hard time keeping their footing at this point, and might even end up falling into the pit on the opposite side of the curtains.

At the same time the marbles are released from the ceiling, a hopper on the opposite side of the corridor opens, spilling still more marbles onto the floor. The characters may or may not notice this, depending upon how alert they are.

The delvers are now faced with the problem of getting across the pit, as the door which dropped behind them cannot be budged. The safest way of crossing is for the party to push all the marbles on their side of the pit down into the hole, and then attempt a running jump for the opposite side of the trench. Of course, the marbles on the far side of the pit won't provide much traction for someone attempting to land upon them . . .

This trap was designed to function regardless of the direction of the party's travel. Thus, by strict function, the trap should spring itself all over again when the party passes the curtain on the far side of the pit. You can ignore or implement this as you please.



Mike Stackpole has developed a pair of corridor traps, both of which use “well-worn” and “common” situations in new and unique ways. Traps such as these are sure to cause problems for those “seen-it-all-before” delvers.

Mike’s first trap is the **Trip Wire That Isn’t**. The main feature of the trap is a standard hinged section of floor, balanced upon a central fulcrum. The floor will give in to the slightest weight; the flipping floor section lets down into a pit, a cage, or to some other horrible fate.

Strung across the corridor on either side of the floor section is a highly visible trip wire. (However, glowing neon lights and flashing arrows would be a bit much.) The wire, when broken, causes two spring-loaded steel spikes to fire into the floor section from the corridor walls, thus securing it for safe passage. If the wire is left intact, of course, the floor section will freely tip as designed.

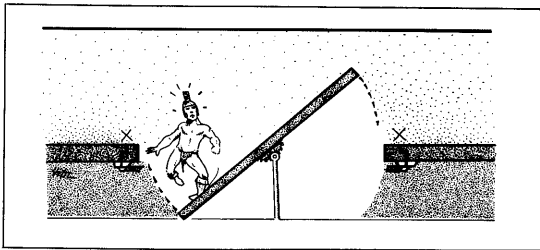

Another trap that punishes eagle-eyed delvers is the **Last Laugh Trap**, also designed by Mike Stackpole. The basic construction of this trap is similar to the “Trip Wire That Isn’t” in that it is also designed around a tilting section of floor. The floor section operates in the standard way, but this time the device opens into a pit filled with the debris of former victims – damaged armor and weapons, bones, perhaps a bit of treasure, and maybe even a magical item or two.

The hinged slab of floor should be fairly easy to locate – either by sight or by the fact that it moves when poked with a staff. Thus, the party can “luckily” locate the trap before it’s too late, and (they hope) decide to attempt to recover some of the treasures below.

The actual trap is located in the ceiling, and is activated when the hinged section of floor is tilted at an angle drastic enough to touch the roof of the corridor (as would be caused by some idiot falling into the trap, or by eager delvers who attempt to wedge the floor section into place so as to better recover the treasures below). When the floor section hits the ceiling in this manner, it depresses a pressure plate, causing the roof of the ceiling opposite it (where the bulk of the party is probably standing) to smash down to the floor.

Once the party has been reduced to paste, a clean-up crew will arrive to sweep the delvers’ remains into the pit where they can serve to lure another group to their doom. Tidy traps are the best traps.

Unsatisfied by visions of Gremlin Guacamole and Hobbit Hash, Stackpole developed another pair of thematic corridor traps. Both utilize a water-filled tunnel; to make them work, you need merely lure the characters into the water tunnel, requiring them to swim through the corridor for a prolonged period until they can discover an airpocket where they can breathe.

The crux of the **Take a Deep Breath** trap lies in the construction of the airpocket. You could, of course, simply neglect to include a pocket at all, but a somewhat more subtle solution would be to fill the pocket with poisonous gas. A knock-out gas, in place of the poison, could render a character unconscious and easy to capture.

Taking this trap one step further, you can place an undiscovered tomb chamber at the end of the water tunnel. The tomb is rich in treasure and is guarded by a mummy.

The tomb's atmosphere is super-enriched with oxygen. As the character has either been holding his breath or breathing water to reach this point, he isn't likely to notice the air change right away.

The effects of this enriched atmosphere will become apparent as soon as some sort of flame is produced (a rather common occurrence when mummies are about). The fire will flare and cause more damage than expected – needless to say, some of this damage should take effect upon the character providing the fire. Shrouding the tomb in darkness might give the delvers further cause to produce a flame . . .

Yet another pair of corridor obstruction traps from Mike will pump new death into old cliches. One is simple, the other is not. Both are deadly.

The first of the pair, **Look Before You Leap**, combines magic and monsters to a terrible end. Inform the delvers that they sense magic coming from the corridor ahead of them. A detection spell will reveal a pit beneath the floor, hidden from view by an illusion spell.

The delvers, not wishing to be surprised by whatever lurks in the pit below, will probably cast some sort of magic to dispell the illusion. Lurking inside the pit is a gorgon . . .

The second trap of the pair is called **Between A Rock and A Hard Place**. The device is a clever variation on the common pit-in-the-corridor trap, and will ensure that characters keep on their toes at all times – or they will lose their toes!

The trap begins with a standard pit in the floor, activated by whatever method you choose. When a character falls to the bottom of the pit, he will find that

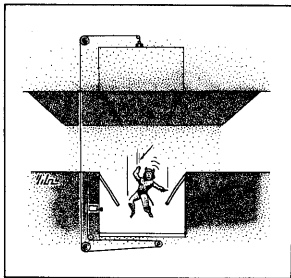

he is in too deep to climb out on his own.

When the trap door slams down against the side of the pit, it pushes a button recessed into the wall. This button causes a vial of acid to shatter, which rapidly dissolves a wire that runs up through the dungeon wall to secure in place the section of roof above the pit.

The wire dissolves within seconds. As long as weight remains on the floor of the pit, however, the pressure plate therein will ensure that the block of ceiling remains in place. If all the weight is removed, then the ceiling drops into the pit, almost certainly crushing anyone who still remains within.



Brandon Corey has designed **The Greystoke Memorial**, perhaps in answer to the much-asked question, "What's a chasm doing in the Death Star, anyway?" I'm still not sure that I understand the reasons for the chasm. But I am sure that I understand the reason for Brandon's residence in a local mental ward.

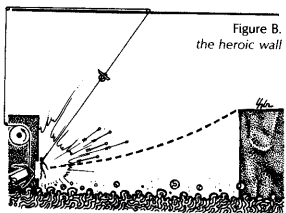
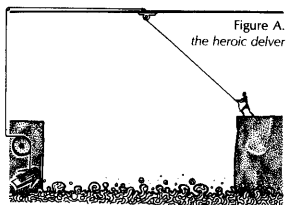

The corridor is broken by a huge pit filled with something nasty – monsters, disgusting fluids, or what-have-you. There appears to be no way to cross the pit. Characters are liable to panic at this point, especially if they're being pursued.

Diligent observation will reveal a block-and-tackle device in the ceiling over the approximate center of the pit. With a bit of luck, a delver might be able to cast a rope to find a secure purchase, to allow the party to . . .

How sickeningly heroic. Anyway, this is where the trap comes into play. The block and tackle itself isn't actually attached to the ceiling – in fact, it's attached to a rope-and-pulley system that will come loose from the ceiling if the full weight of your average dungeon delver hangs from it. The whole tackle assembly will dip sharply down from the ceiling, altering a swinging character's trajectory. Instead of casually clearing the far side of the pit, the delver will slam into the pit wall itself.

To add insult to injury, Brandon has added a battery of crossbow bolts that fire along the delvers' projected angle of flight when tension is applied to the tackle device. Mindless overkill, true, but certainly more fun than watching yet another idiot delver act like Douglas Fairbanks.

We can all “thank” Mike Stackpole for the devilish **Ball Bearing Corridor**. Watch out for that first step . . .

The trap is a section of corridor that has been hollowed out to form a perfect sphere. A spherical section of stone has been set within this cavity, balanced upon fine rollers that allow it to spin within the sphere.

As might well be expected, the fitting of the ball within the cavity is tight enough to ensure that the junctions with the hallway will be difficult to detect. The ball is delicately balanced, and a character who steps into it will cause it to tip. You might wish to increase the tension on the rollers so that more than one character can enter the trap before it rotates.

When the sphere rotates, the characters will fall into the pit below. For added effect, place spikes at the bottom of the pit. If you wish to be especially cruel, install automatic crossbows in the upper half of the trap to further bedevil characters trapped in the pit below. An escape from the trap can be provided through a trap door in the upper half of the trap.

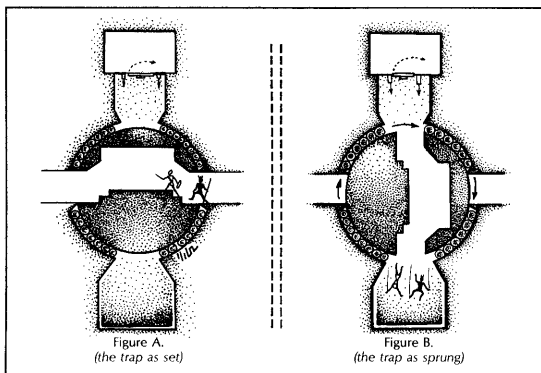

J. Walker designed **The Slippery Pit**, a fine trap that spells doom for those characters who insist upon using tried-and-true methods for evading obvious traps.

Interrupt a standard dungeon corridor with an obvious wall-to-wall pit trap, complete with greased and sloping floor sections. The standard way to avoid this trap, of course, is to pound some pitons into the corridor walls and negotiate the trap by hand-over-hand maneuvers. The problem with this solution is the fact that the walls to either side of the “Slippery Pit” are unusually thin; pitons secured within these walls are likely to come loose if undue weight is applied to them. For an even more devious – and deadly – solution to the “clever delver” problem, conceal a sheet of contact explosive behind the thin walls . . .



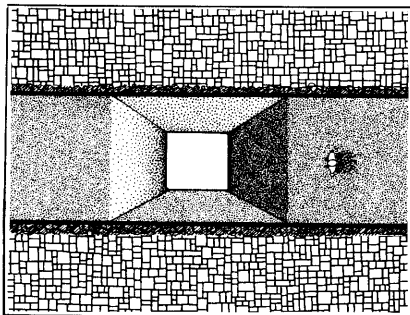

The Slippery Pit
(overhead view)

Detours

Another common type of corridor trap is the detour device, which forces the party off their line of advance and on to some alternate pathway against their will. These traps can be especially useful in dungeons where the floorplan allows the characters to wander around aimlessly while avoiding the provided encounters. Traps such as these insure that the party will “get involved” — whether they want to or not.



A typical example of this trap, **Which Way to the Front?**, was provided by Paul O'Connor. Using a simple set of sliding walls (triggered by either a

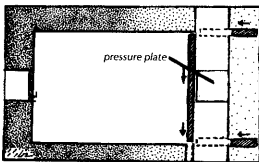

pressure plate or a trip wire), this trap swiftly changes a bare stretch of corridor into a room. Such a room can be occupied by almost anything, but if you should choose to place a monster inside, remember that there's an excellent chance the party could be caught flat-footed by the sudden situation change, with potentially fatal consequences. After the party has dealt with the room

situation, they are allowed to leave through the door — along a different path than the one they wished.

A rather violent method of sending delvers to lower dungeon levels against their will was designed by Jason Lujan. The **Chute and Hammer Trap** activates when the party walks past the pivot point on a plate hidden in the floor. The plate will then tilt down at a 45° angle, dumping almost anyone standing upon it into the aluminum chute below. This chute is very narrow; positioned within it is a hammer designed to strike characters in the forehead with considerable velocity as they slide by. The smaller kindreds might be able to avoid being bashed, but human-sized characters are in for a whopper of a headache.



To make this trap even more deadly than it already is, you could make the chute narrower — ensuring that the characters will fall flat. Then, turn the hammer around so the claw end faces up the chute — this will catch a character under the jaw if he's falling feet-first on his back, or at the base of his skull if he's skidding down on his face. If anyone should survive this treatment, they're free to continue their journey through the lower levels.

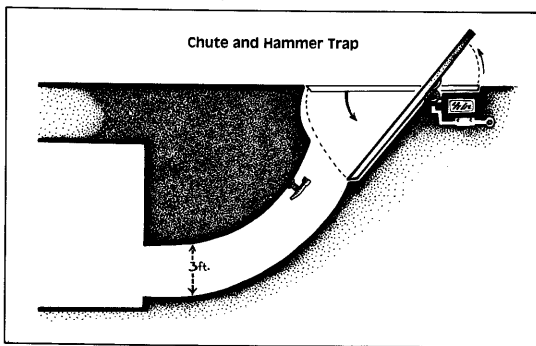

Stefan Jones has developed an even more elaborate means of sending dungeon parties plummeting towards the lower levels against their will. **Orfile's Slide of Delver Dumping** is set up in a side tunnel, off the main corridor, and can be located on almost any dungeon level but the deepest.



In its normal state, the slide appears to be a standard side corridor, leading from the main route at a slight incline and ending in a door. When this door is opened, gallons of eel oil (or some other suitable substance) are released. The oil splashes down the length of the corridor, coating the ceiling, floors, and walls, rendering them nearly frictionless.

At the same time, a large spring concealed beneath the corridor uncoils, lifting the entire tunnel upwards at a sickening angle. Delvers thus find themselves skidding down the length of the corridor at a dismaying speed.

The delvers aren't out of the woods yet. A trap door located in the main corridor snaps open when the spring uncoils, forming an expressway to the

Corridor Traps: Detours

– NOTES –

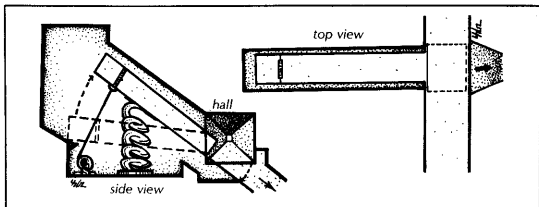

lower dungeon levels. Characters might have a chance to save themselves by grabbing at the rim of the main corridor as they shoot by – but the effectiveness of this move is left to the GM's discretion. Remember to account for the possible actions of any characters who might be standing in the main corridor, out of harm's way, when all this happens.

Dungeon monsters with a sense of neatness can reset this trap by using the hand winch provided. However, I doubt the characters caught by the trap will even notice this bit of consistency, as this ride usually proves to be a one-way journey.



J. Walker developed the **Mapper Maddener**, a corridor detour trap designed to give mappers fits. The trap is located in a corridor intersection, and is composed of a number of sliding wall sections. The sections are designed to rearrange themselves into various positions, altering the basic shape of the intersection into a "T", a straight section, or even a corridor or dead end. Each time the characters pass by, the configuration will be different, playing hob with any maps the party may be making. Of course, the trap will only change the intersection when the delvers are out of seeing or hearing range, thus assuring their confusion.

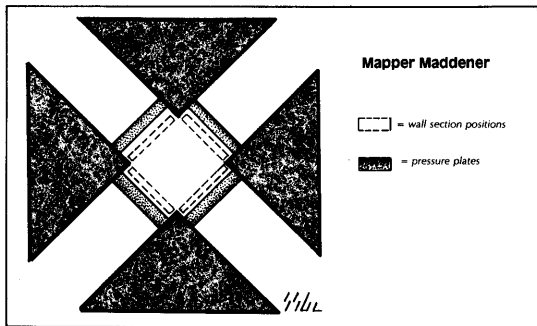

Murderers

While some corridor traps may simply slow or re-route a party, others are not so kind. Many are designed only to kill anything that enters them. Such death usually comes swiftly; delvers have little chance to avoid a gruesome fate. Included in this section are a number of traps involving stairs – for some reason, a stairwell seems a natural place to put any number of fatal devices.

The inherent danger presented by a flight of stairs is well illustrated in a pair of traps from John R. Greer. The first of these, the **Pilum Pacifier**, is particularly ruthless.



The trap is activated when the lead character in the party steps upon a pressure plate concealed within the trigger step, causing three pilums to spring forth from the stairs to a distance of eight to ten feet. The pilums will strike three specific areas: three or four feet above the trigger step, an equal distance above the step below the trigger step, and about four feet above the step below that. Thus, if a pilum doesn't strike

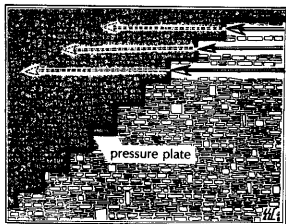

the lead delver, it may still hit the character who stands next in line. The GM should determine the extent of any damage done to the characters on the stairs, and should take into account exactly where the delver was hit. The construction of this trap, combined with the wildly varying heights of dungeon delvers, makes it possible for a character to be struck *anywhere* by a pilum.

Another of John's traps also takes its toll upon parties who venture up a flight of stairs. Called **Folly Flight**, this trap utilizes a deceptively simple construction to devastating effect.

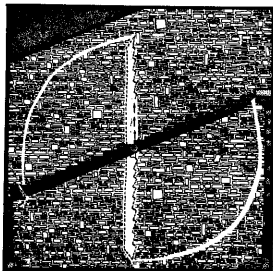

The section of stair that comprises the trap perfectly matches the rest – but is in reality a carefully-balanced ploy. If enough weight is placed on these stairs uphill of the fulcrum, the entire device will swing downward, dumping the party to whatever unkind fate the GM has waiting below.

Exactly when this trap is triggered is a matter of logic and

Corridor Traps: Murderers

– NOTES –

discretion. If a single character navigates the stair, he might feel a shifting beneath him as a forewarning when he crossed the fulcrum. Depending on his speed, he might actually recover in time to retreat back over the pivot point. If the character was running, the chances of his doing this are very slim.

If an entire party moves along the stair, the weight won't begin to shift until the bulk of the procession has crossed the pivot point. How radical the shift of weight is will determine the speed with which the stairs drop away.

Note that the stairs are supported only at their downstairs end. Thus, a character who sets foot upon the trap from upstairs would instantly trigger this device.



An especially fiendish corridor trap, the **See-Saw Corridor** by John T.T. Longenbaugh, could prove to be the death of even the toughest characters.

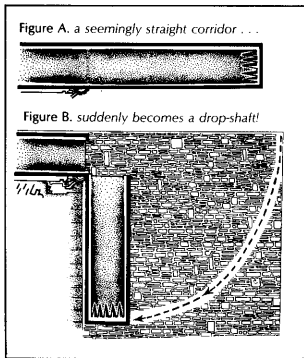

The trap works best in unlit corridors, to conceal the spikes that will eventually lead to the delvers' doom. The trap is similar to "Folly Flight" in that a significant amount of weight must move past the pivot point to trigger it, but the consequences are a bit more sinister. In a matter of seconds, the corridor that had provided safe passage becomes a deadly drop-shaft! The specifics of the damage caused by this trap are, of course, left to the Game Master, but the compounded menace of a long fall and impalement will probably do most characters in.



Paul O'Connor has designed another corridor trap that uses spikes to grim effect: the **Supercharger Crawlway**. Located in a low crawl-space off the main dungeon corridor, this trap should provide a fatal surprise for anyone foolish enough to venture within.

The crawlway is just large enough to permit passage of a normal-sized human being. The fit will be very tight, and the delver will find it impossible to turn around. Near the end of the crawlway, the character will discover a number of rubberized wheels that barely protrude into the passage through the ceiling and floor.

If the character continues, his pressure upon the wheels will trigger the trap. The primary gears begin to turn at a terrific rate, shooting the helpless character through several feet of corridor and into the room beyond. Travelling at a speed of approximately 60 miles per hour, the character bursts into the room and encounters a wall of spikes. If there lives a character who could withstand such ghastly punishment, I certainly wouldn't want to meet him.

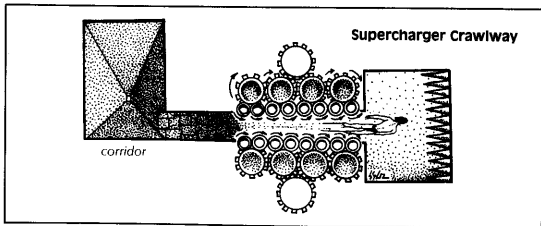

Another form of grim corridor doom, **The B-B Slope**, was submitted by Rick Loomis. A side tunnel leads away from the main corridor, and ends in a door. The wall at the door's base is covered in spikes. Beside the door at the end of the tunnel is an unmarked lever.

The door will resist all attempts to open it (in fact, it cannot be opened at all, as it is only a cleverly-disguised section of the wall). When the lever is pulled, a section of the door is lifted, releasing a hoard of ball bearings into the corridor. The characters will probably lose their footing, and slide to a painful fate on the spikes below.

To make this trap less suspicious, the incline could be replaced by a flight of stairs. While a person won't slide down a set of stairs, a tumble down them might do as much damage as the spikes at the far end. You could thus dispense with the spikes altogether, and still have an innocent-looking but quite dangerous trap.

Another possibility is to have the door release oil instead of ball bearings. The substance would certainly cause the characters standing in the tunnel to lose their footing, and if one of them were to drop a torch the corridor could quickly become an inferno.

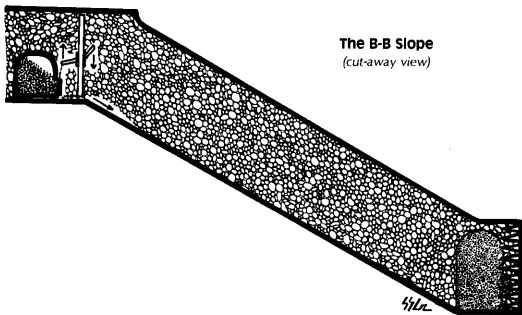

**Corridor Traps:
Murderers**

– NOTES –

The Rolling Stone is another corridor-murder trap that Rick is fond of. This trap presents the party with an enormous stone ball bouncing down the center of the corridor. To avoid this threat, the delvers will (naturally) throw themselves flat against the corridor walls.



Unfortunately for the delvers, the corridor walls are covered with many small, poison-coated spikes. Such a surface can prove very uncomfortable to an unarmored character.

The only way to defeat this trap is to either wear clothing of sufficient thickness to thwart the spikes, or to step into the stone ball. The ball, after all, is simply an illusion, and will vanish upon contact.

Brandon Corey developed a pair of killer corridor traps that operate along the same lines. Both are a gas.



The first trap is the **CO₂ Delver Extinguisher**. This trap is constructed by

filling a tall room with carbon dioxide. An invisible wall or something similar is placed across the entrance to the room. For best results, the room should be located at the end of a corridor, preferably down a flight of stairs.

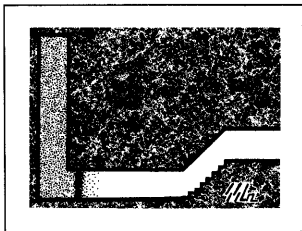

When the invisible wall is breached, the room will fill the corridor with carbon dioxide. Torches (and hopefully, delvers) will be extinguished.



Corey's second trap is the **Von Hindenburg Chamber**. This trap is a reversal of the "Delver Extinguisher"; this time the invisible wall seals off a deep pit of hydrogen from a corridor. The stair and corridor arrangement remains unchanged. When the wall is breached, the hydrogen flows out of the pit and into the corridor – creating an inferno about any character who carries a lit torch . . .



Uriah Ward developed **The Avenging Treadmill**. To function properly, this trap should be located in a *cul de sac* corridor where the room at the end contains something so horrible that the characters are likely to flee from it.

The corridor in question is, in reality, a treadmill device. The treadmill will not activate (begin to roll) until a character triggers it by opening the door at the end of the corridor.

When the party opens the door and greets whatever horrible fate you have in store, they will almost certainly attempt to flee back down the corridor. When this happens, the effects of the treadmill will become apparent. The characters will be running in place, while the horror behind them gets closer and closer!

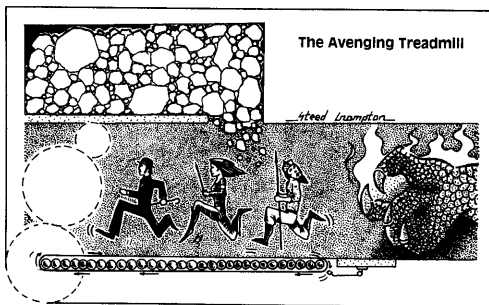

To make matters worse, running upon the treadmill activates a gear assembly, which will pull aside the ceiling above the characters. This should release upon the characters a torrent of something nasty: for instance, a load of boiling oil or a small avalanche.

A very simple – and thus very effective – corridor trap is **Air The Well**, by

J. Sutherland. Fill a room at the end of a corridor with a vacuum, then seal the room with an airtight piece of glass or an invisible wall. Beyond the glass, place a grillwork of spikes and barbs. When the restraining wall is breached, characters in the corridor beyond will be sucked forward – and into the deadly grillwork.

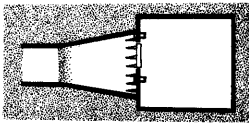

Step and Die

A distinguishable sub-class of the “Corridor Murderers” type of trap is the “Step and Die” variety. Traps of this type are uniformly activated when someone treads upon their trigger mechanism. These traps respond directly to the delver – usually through a direct extension of the trigger mechanism itself, rather than a mundane caving in of the ceiling upon the party’s heads (or some similar fate).

Due to their construction, traps such as those which follow lend themselves well to a variety of locations beyond corridors and tunnels. With little or no modification, the step-and-die traps will function as well within rooms or treasure chambers.

Corridor Traps: Step and Die

– NOTES –

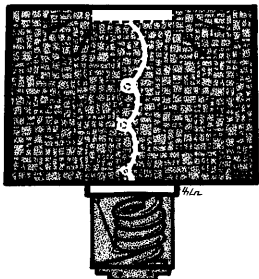

The Smashing Floor Trap

by John T.T. Longenbaugh is a basic example of the step-and-die trap. The trap is activated by a pressure plate, designed to cut loose when at least 75 lbs. of pressure is put upon it.

When the trap is sprung, a tightly-coiled spring sends the entire floor section slamming against the ceiling. Most anyone caught by this trap is a goner – or, to quote John: “The person can be mailed to the funeral using only one stamp.” Of course, John made this comment before the postal rate increase . . .



Using the classic principle of transforming a child’s toy into an engine of death, Mike Stackpole developed the **Whirling Blade Boot Bloodier**. Propeller toys were never so cruel.

The trap is activated when a delver steps upon a pressure plate. Set below the plate is a long iron screw, set at the base of the screw is a spring-loaded razor-edged device that looks very much like a wing nut.

For this trap, the flooring should be of tile or flagstone. The length of each of the wings on the wing nut should be just short enough to allow the knife to spin freely inside the hole without striking the sides of the shaft.

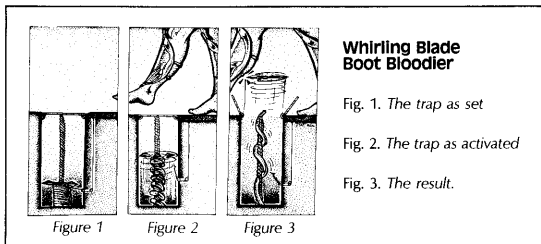

When the trap is activated, the spring forces the whole nut assembly up the length of the screw with split-second precision. The nut completes its flight by bursting through the false tile above it and (with any luck) cutting into the character who stands above.

The consequences of this trap are almost certain to be crippling. After being hit by this device, a character will probably find it impossible to walk.



Another device that should prove rough on legs is the **First Step Trap**, by Lara Abrash. This trap is sure to make characters look before they leap.

The trap's construction is as simple as it is devastating. When a character steps upon a pressure plate, the tile slides away. A rack of barbed, razor-sharp blades flips forward, cutting into the back of the leg and heel – perhaps even severing the foot entirely.

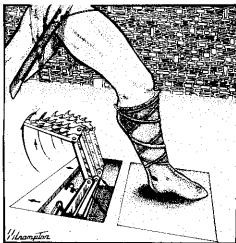

Another evil corridor trap, **Crossbow Thirteen**, was developed by John R. Greer. This devilish device is so named because it employs no less than thirteen individual crossbows to achieve an effect roughly equivalent to an exploding land mine. This trap is a wonderful example of the kind of outrageous overkill and ruthless violence found in some of the most delightful traps.

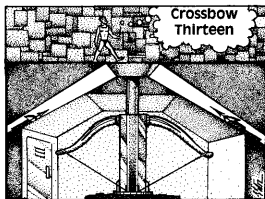

When a delver steps upon a designated section of floor, the giant, loaded crossbow beneath the floor will fire, launching its quarrel (and the chunk of flooring at its head) up towards the ceiling. This may or may not clip the character who actually stepped upon the "mine", but it will almost certainly hit the next delver in line.

The worst is yet to come. After the main crossbow has fired, twelve standard cranequins open up from a sequence of shafts placed in a circle about the main quarrel. This "shrapnel" flies forth at about a 17° angle to the floor. These arrows might strike anyone standing within 12' of the trap.



The **Stair Snare** is a simple trap submitted by Mark O'Green and Edward Schoonover. This trap will work especially well if placed in a location frequented by wandering monsters, or within a room that is rapidly filling with water. The character, probably trapped, will thus have even more to deal with than the

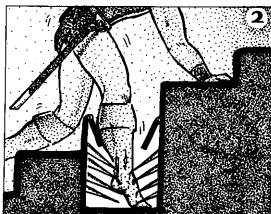
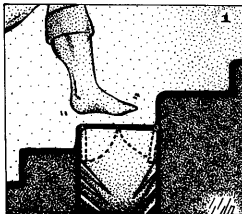

Corridor Traps: Step and Die

– NOTES –

pain that the snare offers.

The trap is encountered when a character sets foot upon a false section of stairway. The step gives way, allowing the foot to pass through to become ensnared in the barbs below. While the foot will probably pass into the step without suffering excess damage, pulling it out again is another story altogether – especially if the character is in a hurry.

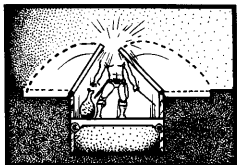
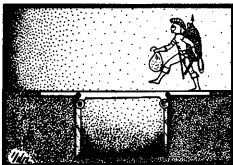

Mark O'Green and Edward Schoonover developed the **Hero Sandwich** trap. Pass the ketchup. The trap is really a very simple one. Cover a shallow pit with a pressure plate. When a delver steps upon this plate, his weight will cause the plate to fall, bringing hinged sections of the same plate together in a slapping motion in the approximate region of the delver's head. Add a tomato, a pickle, and perhaps a bit of lettuce, and you're ready for lunch.



The Plano Floor, by Liz Danforth, is a scream.

Place between the slats of a tile or wooden-slat floor a number of extremely sharp, long razors. Beneath each slat should be placed a spring that will depress when the corresponding floor section is stepped upon. The result is a painful one.

For best effect, this section of floor should be located in an area that's likely to accept a sudden, great weight: at the base of a balcony (where someone is likely to land if he jumps), or in a section of hallway through which someone is likely to run (as if pursued).



The Flesh Pot, from Pat Mueller, technically isn't a "step-and-die" trap; more accurately, it's a "step-and-stick" device. This trap is simply a pot of sticky goo. Place the mouth of the pot in most any convenient place, where it will receive a limb – beneath a false section of floor, or deep within a hole that someone is likely to reach into. The goo instantly adheres to the delver's flesh. The pot can be pulled from its hiding place, but the limb cannot be pulled from the pot!

3

Door Traps

Doors are probably the most overlooked items in a dungeon, and with good reason. By and large, doors are usually transition devices between areas where the real action takes place: a warm-up act for the main attraction. As such, doors become commonplace objects, tackled with little caution and quickly forgotten.

A few well-placed door traps will put an end to this. Operating as they do – when a delver's guard is down – traps such as these are likely to create a high number of casualties. They will also lead to widespread, unreasoning paranoia, for if your best buddy gets fried by the first dungeon door, you can bet you're in for a tough trip.

Knock knock . . .

Door Traps

– NOTES –



The Circular Doorway is an insidious door trap developed by Pat Mueller, and uses yet another common item to deadly effect. Present the delvers with a circular, doorless portal. The party will find that they can see a rather foggy image on the other side of the door (the room on the far side should be at least partially visible).

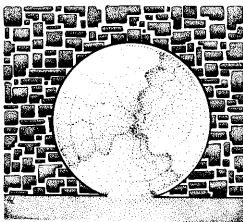

Actually, an enormous fan whirls within the doorway. Being virtually noiseless, it is almost impossible to determine that the fan is present until it is too late. The fan blades are equipped with tiny barbs and jagged edges to ensure that most anything touching them will be drawn in.

If the delvers carry torches, they might be able to detect the presence of the fan by the fact that the torch smoke is drawn towards the doorway. If, however, the characters don't realize the significance of this, then they fully deserve what they get.



Another dismal doorway doom device was provided by John R. Greer. His **Giant's Razor** is designed to wreak havoc upon "standard door-opening techniques": standing to the side of a door as it is opened.

The door trap is held closed only by a common latch. When the latch is lifted, the weight of a 20-lb. razor poised beyond – coupled with a powerful spring – will force the door to fly open. Unless the character is trying to hold the door closed, the portal will swing open and the blade will swoop through.

The razor's effect depends upon where the character stands. If he stands to the latch side of the door, he is in great danger of having his arm amputated. If he stands in a line with the middle of the door, the razor would probably hit him in the upper torso. A character who stood on the far side of the door from the latch would probably escape unharmed.

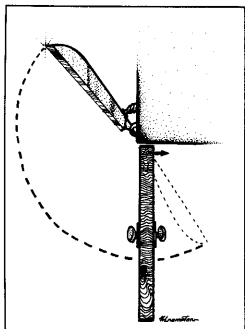

The Guillotine Door Trap by James Brazier and Oliver Fittock makes further use of blades and doorways to evil intent. Simple in construction, this trap simply drops a guillotine blade through the door jamb shortly after the door is opened. Severed limbs or bodies will result, depending upon the circumstances.

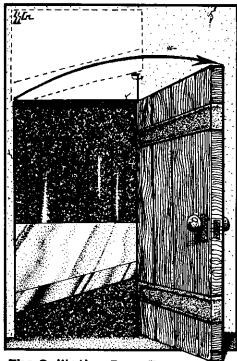

The Guillotine Door Trap

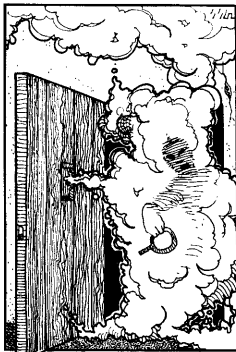

Poison Door

Rick Loomis' **Poison Door** is a somewhat more subtle device. Just because a door has a handle doesn't mean you have to use it — and if the delvers just push this door open, they'll live. Otherwise . . .



The trap is a hollow door filled with poison gas. The door is equipped with a plug "handle" which, when pulled out, releases the gas.

A somewhat more deadly (if that is possible) variation of this trap would be to fill the door with methane instead of poison gas. Odorless and colorless, methane ignites explosively in the presence of open flames (such as lamps and torches). Thus, if the delvers stand before the door, gaping at the "handle" and the hole in the door, doing nothing while methane floods the corridor about them, they probably wouldn't recognize the danger until the corridor exploded in a flash of fire.

The **Cure A Kicker Trap**, by S.S. Crompton, is a much less subtle door trap, designed to take care of "lead-boot" dungeon delvers who enjoy kicking in expensive dungeon doors. After all, turn-about is fair play . . .

The trap is triggered around a weighted wire located within the door. As long as the door is opened normally, no appreciable dislocation of the wire will occur, and the delvers can

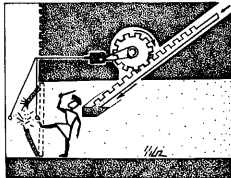

proceed safely. If, however, the door is broken (as by a kick), then the wire will be freed, loosing the gear structure above to propell a large, spear-like beam towards the character.

The “Cure A Kicker Trap” presents a wonderful display of overkill, but unless it is placed within a locked or hard-to-open door it will probably see little action. However, if you combine this trap with one of the other door devices listed in this chapter, and you have a two-edged doom-dealer sure to shred any delver.



Mike Stackpole has developed a trio of traps to spice up otherwise dull dungeon doors. The first of these, the **Dry-Rot Door**, works along the same lines as the “Cure a Kicker Trap” – but accomplishes its purpose through considerably less elaborate means.

The “Dry-Rot Door” deals with foot-loose barbarians simply by being unexpectedly weak. The character kicks completely through the door, and a creature waiting on the other wide neatly amputates the limb.

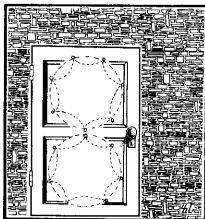

Mike’s **Dragging Doorway** deals with door-kickers in still another way.

Simply anchor a snare on the upper panel of the door; anchor another snare on the lower panel. A vicious kick or punch through either panel – and the snare captures the offending limb and drags it through the door into the room (and presumably off to meet some horrible fate).

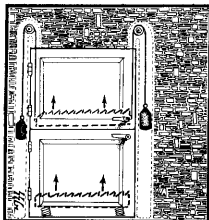

Double Door Doom, another product of Mike’s warped imagination, provides yet another variation on the blades-and-doors type of trap. This trap’s double-door construction also leads to several other possibilities for otherwise mundane dungeon doors – your doors needn’t always be standard rectangular items from the warehouse . . .

The “Double Door Doom” sports a spring-loaded blade in its lower half to slide through anyone who opens the

upper door and leans through. The multi-purpose location of the lower door, along with a second blade in the upper half, also assures that anyone who punches through this door won't keep his limb for long. When will delvers learn to simply open doors and walk through?

The **Delvermatic Dicer and Malignerer Trap** was designed by Liz Danforth and Mike Stackpole to take care of characters who open secret doors with gay abandon, but refuse to walk through them.

The secret door in question is set flush into the wall, and is designed to open by sliding into the ceiling. When the door is thus opened, delvers will see a net-like web of monofilament line on the other side.

When the door slides up, it causes a section of the ceiling to swing down into the corridor. The arc of the section is such that it should slam into any character standing roughly six feet from the door. A devilish free-swinging hook trails the ceiling section, spelling doom for any delver standing about four feet from the fellow flattened by the ceiling section. (See Figure 2.)

The ceiling section completes its arc by slamming into the floor – which is in reality a carefully-balanced platform. This creates a catapult effect, and should send anyone standing as far away as twenty feet from the door flying into the spiked side of the ceiling section. (See Figure 3.)

The poor idiot who opened the door in the first place is in for the worst fate of all. Bay doors kick out from the falling ceiling section when it finally hits the floor, propelling the hapless door-opener through the fine monofilament mesh – with the appropriate “cheese-grater” effect. (See Figure 4.)

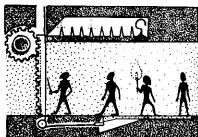

Figure 1.

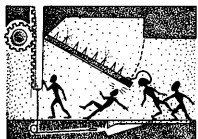

Figure 2.

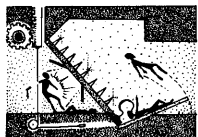

Figure 3.

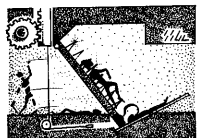

Figure 4.



4

Items and Artifacts

Most traps offer some sort of “bait” to lure delvers to their doom – gold, jewels, devices of power, or some other tasty tidbit. After a steady fare of such “outwit the trap and get the treasure” situations, you’ll probably find that the delvers in your dungeon respond to all your devices with Pavlovian predictability. This is where items and artifacts come in handy.

The traps in this chapter take the “bait” concept to its logical conclusion – they cause the bait itself to be the trap. No elaborate machinery or bottomless pits are used here; items and artifacts as traps substitute subtlety for overkill.

The items in this chapter work best when placed among standard treasures – especially if said treasures are already guarded by some horrible beast or snare. With obvious guardians to meet and defeat, characters rarely bother to search for further dangers when they finally make it to their “reward”. Rather, they have a tendency to scoop up everything in sight with both hands. Their guard is down – and that’s when the fun begins.

All that glitters is not gold.

Item Traps

– NOTES –



Mike Stackpole, a trap designer with an evil mind, has an odd knack for coming up with bizarre and esoteric item traps. An example of the sort of treasure you can expect from Mike is exhibited with **The Hot Rocks**, a necklace with a twist. Found in a fountain of water, this necklace is a chain of precious metal set with six round stones and a diamond. The diamond is enchanted with some vaguely beneficial magic: perhaps the ability to breathe water or undertake limited flight (nothing too powerful).

The six stones of the necklace are phosphorous, an element that will burn after prolonged contact with air. The water in the fountain insulated the necklace from the air, preventing combustion. Shortly after a delver removes the necklace from the water (and places it into his pack or around his neck, you hope), the phosphorus will undergo a heated transformation.

Note that the diamond remains magical, regardless of what happens to the phosphorus stones. If you describe the magic upon the diamond by saying something like, “When worn, the diamond will . . . (whatever),” a smart delver *might* reason out that he can take the diamond and discard the necklace, thus gaining the magic and avoiding the consequences. No one said that the diamond had to be worn with the necklace to work . . .



Another item from Mike that operates along the same lines is the **Nefarious Nymph Statuette**. This is an insidious device if there ever was one. Behind a waterfall of some sort stands a grotto or alcove, enchanted by latent magic to remain perpetually dry. Within the grotto sits a mound of treasure; resting atop the treasure is a beautiful statue of a water nymph. The statuette is made of a silvery white metal and stands about two feet tall. It is obviously of great value.

The statuette was sculpted from pure sodium, an element that will combust upon contact with water. When the characters carry this item back through the waterfall, it will almost certainly become wet and explode. The chances are very good that the character bearing the statue will be killed. Any characters who stand near the blast could be severely burned.



But Mike hasn't finished yet. He's come up with still another trap that turns an otherwise useful item into an engine of destruction. It is called the **Magnesium Torch** – as the name might indicate, it provides yet another vehicle for Mike's concept of “elemental” doom.

The item takes the form of an ornate metal torch that will burn oil. Once lit, this torch will burn brighter than a standard pitch torch. The oil reservoir is equipped with a lip, so the oil will not easily spill out.

The problem with “The Magnesium Torch” is that near the bottom of the oil reservoir is attached a strip of magnesium. When filled with oil, the torch will burn normally for 2½ to 3 hours. Around the third hour, however, the oil will be exhausted, and the magnesium strip will be exposed to the flame. Depending on the amount of magnesium in the strip (and/or the addition of a possible thermite core to the torch), the flash explosion that results will burn the characters. They will suffer anything ranging from surface wounds to the loss of a hand or two.



Mike moved away from the “elemental” theme for his next device. Considering the violence involved, one is led to wonder if a delver might not prefer to have his hands burned off or his clothes catch fire. At least with these fates there is a slim chance of survival. The **Spy Glass** offers no such opportunity.

The device looks like an everyday hand-held telescope. It radiates some magic. A person who looks into it will see a blurred picture of an attractive member of the opposite sex.

The act of focusing the “Spy Glass” moves a small ring inside that has been holding back a spring-loaded dagger. This dagger, a thin-edged blade, will enter the eye and perhaps the brain. Death (or at least blinding) is the result.

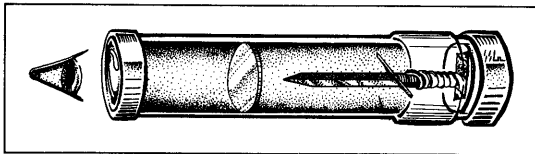

Liz Danforth and Mike Stackpole pooled their talents to create the **Moviola**. This device shows a devilish cruelty: it takes a character’s money and does its level best to kill him.

The “Moviola” is much akin to the little movie viewers common in numerous arcades. It will screen a film of a beautiful woman who removes veils in the fashion of a belly dancer. The film is in four sections, each revealing more than the last; each revealing will cost the viewer 25 gold pieces to watch. After 100 gold coins have been paid, the woman will remove the final veil – the one that covers her face and head. When the final veil falls, it will be revealed that the woman is a gorgon, and the viewer will be turned to stone.

The moviola machine is ideal for the back of a bar. The machine itself might even be a demon that could either attack the delver or simply laugh and run off with the gold.

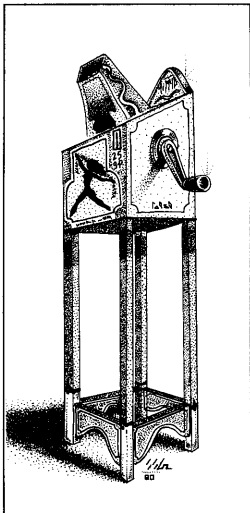

Item Traps

– NOTES –



Charles Scott Kimball has designed what purports to be a **Theft-Proof Gem**, a diamond of considerable value (nothing less than 8500 g.p.). It originally belonged to an extra-terrestrial traveller, now long dead, who implanted a tiny electronic device in its center to protect it from thieves.

When anyone (except its attuned, alien owner) picks this gem up, the jewel will cause everything the delver wears to heat up at an alarming rate. This causes progressive damage to the character. If the gem is carried for more than ten minutes, there is a significant chance his metal armor will melt and his poison flasks will boil over.

Because the gem is a technological device, it will radiate no magical vibes. The wiring within the gem can be noticed only upon a very close inspection – and removing the device will ruin the gem.

Carring this item in a box or pocket will not stop the effect. The gem can only be “turned off” by throwing it away, or by having the delver strip himself of *everything* but the gem, leaving nothing for the diamond to heat up. The delver is thus faced with the unpleasant choice of either throwing away an extremely valuable gem, or of walking through the dungeon armed with nothing save a huge diamond – and what monster could resist such a target?

While high-tech items won't fit easily into every dungeon, this item could prove a bit more useful than most. If the gem were included as a single jewel within a much larger hoard, the delvers might leave the entire treasure behind if they couldn't locate the troublesome gem. Or, work the gem into a piece of armor or a ring – when worn, this item would thus cause the damage. In any event, when using this gem be sure to take note of the consequences for the more flammable belongings of the delver who was stupid enough to pick the gem up – cloth, hair, feathers, wooden items and bowstrings would probably be the first to combust.

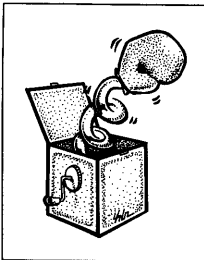

A “quickie” item to include in your next treasure hoard is the **Jerk With The Box**, by Paul O'Connor. This item resembles an ordinary jack-in-the-box toy in all respects, and will resist all attempts at opening until the crank is turned. The box will play whatever tune you choose and then open – letting the spring-loaded boxing glove fly into the face of anyone dumb enough to hold the box. If you want to make the trap deadlier, substitute a punch dagger for the glove. For a stranger variation, load a cream pie within, instead.



Another bizarre item trap is the **Stuffed Raccoon**, supplied by Stefan Jones. This item – a stuffed and mounted raccoon that radiates intense magic and is indestructible by normal means – can be placed in most any convenient place around your dungeon. The enchantment on the raccoon is such that when it is placed within a closed container (such as a delver's sack of loot), it will wait for fifteen minutes and then return to the place it originally occupied – along with

whatever items may have been with it in the sack at the time. The monsters of a dungeon usually catch on to this sort of thing rather quickly, and will probably haunt the area where the raccoon will return, eager to grab any treasure that might come back with it.

Harley Bates has developed a very strange item trap indeed. Whether or not it is truly an item is debatable – it's probably best defined as a creature *disguised* as an item . . .

In a few rare caverns there lurks a strange animal which few delvers will recognize, due to its similarity to a more familiar item. This creature is known as the **Rope Serpent**.



Characters may put the rope to whatever use they choose. When they are done, it is hoped that they will store the rope in their equipment pack for future use. That's when the fun starts.

A little while later – minutes or hours, whatever is convenient – you can put this trap into action. The character who carries the “rope” should be handed a card that says:

“That rope you've been carrying is, in reality, a very rare ‘Rope Snake’, and while you've been travelling along, it has carefully and silently wrapped itself around your neck. Don't be surprised that this went undetected – these snakes have been doing this sort of thing for hundreds of years and have gotten quite good at it.

“There is a minute chance that you might survive this encounter – but don't bother screaming for help, as the snake has tightened itself around your windpipe and speech is impossible. Fight for your life.”

The Game Master should implement whatever game system he or she feels comfortable with for resolving the character's battle with the snake. The other party members can attempt to aid the choking character if they notice something is wrong; usually the character will be dead long before the other characters realize that something's happening. To preserve the element of secrecy for the combat, you may wish to include the saving roll or fighting information for the player right on the card.

This trap will usually work on players only once – after that, the delvers will be on guard. If, however, the snake strikes when the character is off alone someplace, this trap might actually kill more than one delver – there will be no evidence as to what killed the character, except possibly for a harmless coil of rope in the character's pack, just waiting for someone to pick it up.

Significantly less fatal, but every bit as insidious, is the **Speak Down** trap by S.S. Crompton. Disgusted by the way excessively vocal delvers frequently take undeserved control of a party, Steve developed this item trap. Given the proper circumstances, and some smooth talking by the Game Master, this item could very well put a game back on even footing.



The trap takes the form of a bottle of blue liquid labelled “Blue Rose: *Bottled by the Voiceless Ones*”. No magic can be detected from either the bottle or its

Item Traps

– NOTES –

contents – in fact, the liquid smells like a fine wine.

The liquid contains a mixture of rare and powerful chemicals known only as *Kromptonite*. This mixture, when imbibed, causes an instant paralysis of the vocal cords for a duration of not more than twelve hours. Any character drinking from the bottle will be struck dumb. The person playing the character is restricted to making gestures and writing notes – he may not speak again!

With a bit of luck and some crafty maneuvering, there's a good chance you could trick the party leader into drinking from the bottle. This will force the usually quiet characters to speak up, and might even lead to the doom of the "Big Mouth".

For our collection, Ken St. Andre has passed on a few items from the bowels of Gristlegrim. Both are magical in nature, but the enchantments involved are rather unique.



The **Lightning Gem**, found atop a pile of ashes on a table, takes the form of a huge and beautiful fire opal set in a golden ring. The gem is obviously magical, but the exact nature of the enchantment is protected from detection.

The gem is ensorcelled so that if it is ever lifted above the wearer's head it will call forth a powerful bolt of lightning, causing considerable damage to the bearer! The gem will remain intact, no matter how many times it is struck by lightning. The GM should give no hint as to what the gem will do until such time as the wearer fulfills the condition of placing the ring above his head.



Another of Ken's treasures is the **Idiot's Vase**, which will point out how *stupid* some delvers can be. The item is an enchanted crystal vase; eighty gold pieces are visible inside. The vase itself radiates negative magical vibes. Whoever carries the vase will lose 2 strength points per turn. Whoever breaks the vase will lose 6 intelligence points. Whoever reaches into the vase will turn blue, unless he is already blue – in which case he turns green. All attribute losses and changes are permanent.

The way to defeat this trap is painfully simple: merely turn the vase upside down and pour the gold out. Delvers whose mentalities are geared to destruction will seldom think of this.

Liz Danforth has developed a trilogy of item traps each designed to deliver unto a delver a deadly dishing of dismay. Each trap, being essentially simple in construction, should work well in seemingly "harmless" locations.

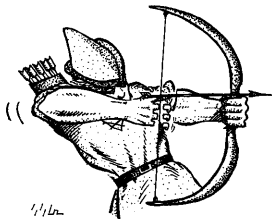

The thought of encountering **Satan's Bow** makes me wince. This metal bow is skillfully crafted and glows with a magical radiance. The light is really just a sucker's hook, designed to attract characters grabby for magical items. The bow is enchanted with a self-contained light spell to maintain this deception.

The trap portion of the bow lies in the bowstring. The string is made of a very fine, diamond-dust studded wire. The bow itself, being made of metal, will not have the flex one would expect. The result – anyone trying to draw back the string of this bow will lose three fingers for the effort.

The only way to avoid this fate is to use a thumbing when drawing the string, which is sharp enough to cut through even light leather gauntlets (and anyone who tries to use a bow with anything heavier will experience a great deal of difficulty).

The **Cup of Golden Mead**, another trap item from Liz, is as simple as it is direct. Present the delvers with a sideboard laden with goblets, each of which contains a magical drink of “golden mead”. The mead, when it hits the stomach, is transformed into an equal amount of molten gold. The character who imbibed the mead won’t survive, but the party gets the cash – provided they’re not too squeamish, or have “cast iron” stomachs.



Liz’s final item trap is a device she calls **The War of the Ring Trap**. The trap takes the form of an ornate pedestal, with the words “War of the Ring” inscribed upon it in several different languages. Atop the pedestal rests a beautiful unadorned golden ring.



If a character is bold enough to take the ring, he learns that the ring is attached to the pedestal by a wire which allows the ring to be pulled away only so far before tugging back. The result is a somewhat comical tug-of-war; the results are subject to the particular characters involved in the battle.

If the ring wins, well and good. It returns to its place on the pedestal. If the character wins, and sticks around to pat himself on the back, he’ll find that the ring and wire constituted the pin assembly of a hand grenade located in the pedestal ...

Uriah Ward has contributed an interesting item trap, guaranteed to ensure that your characters **Have A Ball**.

To use this trap, you must install a bowling alley somewhere in your dungeon. Make it fully automated, and award gold pieces or somesuch for each pin knocked down. After a while, balls are returned to the characters that have poisoned spikes carefully located in the fingerholes. *Strike!*



Michael Austin has developed a pair of bizarre item traps. Each uses the familiar function of a common item to gruesome effect.

The first of the two is the **Vincent Van Gogh Seashell**. The trap is magical, but is very simple in function, and takes the form of a beautiful seashell. The shell will seem to emit low whispers, inspiring a delver to pick it up and hold it to his or her ear.



At this time, the magic of the shell activates – the delver’s ear is teleported to a loved one. And every character has at least a mother. This trap is put to best effect when placed within a treasure hoard.

Item Traps

– NOTES –



Here, Doggie! is the second of Austin's item traps. In this case, the trap is easily recognizable as a simple dog whistle. The whistle will allow limited control of canines – but is also magically enchanted to attract wandering monsters . . .



Michael Stackpole gives us **A Cask of Immolation**, a trap sure to set your imagination on fire. The trap is a simple oil barrel, complete with a pump and spout for the convenience of delvers who wish to refill their lamps.

What the delvers don't see is the sparking sub-assembly attached to the pump. When oil is pumped from the barrel, a steel rod will strike a flint strip located in the assembly, creating a number of sparks. These sparks, when coupled with the volatile nature of the oil, spell an explosive situation.



S.S. Crompton has developed a number of item traps that turn usually trusty weapons into very nasty devices indeed. Each operates upon a principle of surprise for its effect.

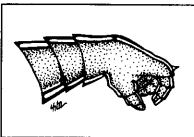

One such item is the **Gauntlets of Doom**. These gauntlets appear normal in every fashion, and will comfortably fit any normal-sized human. To make them more attractive to prospective delvers, you might wish to forge the gauntlets from silver.

The problems with these gauntlets will become apparent the first time someone tries to punch something with them. The gauntlets are equipped with a thin bladder located between the lining of the glove and the external metal surface. If something is struck with sufficient force the bladder will break, spilling its contents onto the hands of the wearer.

Naturally, the bladder holds a fatal contact poison.



Another of Steve's item traps is called **Turn-About is Fair Play**. This is a trap that is sure to come back and haunt the delver.

The trap is a finely-crafted curved throwing knife. It is well-balanced, and an obvious treasure for anyone interested in weaponry. However, the knife has been made so that it will boomerang when thrown. A character who hurls this knife at a foe has a fairly good chance of having it return at his face . . .



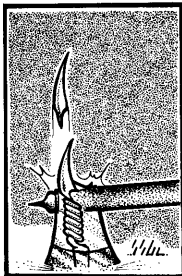

Well Blow Me Down! is sure to make the delvers in your dungeon choke out curses to your cruelty. The trap is an intricately-designed blowpipe that has been curiously constructed. When used, the poisoned dart within the blowpipe is sure to go down the delver's throat instead of towards an enemy.

Bury the Hatchet is a grim item trap indeed. The construction of the axe is such that its spiked backside will explode back into the face of its wielder when a solid object is struck. A spring-loaded chamber assures accuracy.

More insidious than the hatchet, yet every bit as deadly, is the **Achilles' Shield**. This trap takes the form of an ornate and beautiful shield, finely balanced for combat. In all aspects it is a fine and trusty shield, and should serve its owner through any number of desperate fights. There is, however, a small 2"×2" area in the shield that is incredibly weak – weak enough to admit a well-placed spear thrust. This trap might take a while to be discovered – but its discovery is likely to be fatal, when some stooge gets in a lucky shot, and the delver's otherwise-trusty shield crumbles before him.

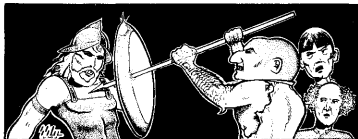

An even more subtle item trap is the **Cape of Dorian Grey**. The cape is old and tattered, yet looks like it might be worth picking up as a souvenir. The longer a character wears the cape, the better the cloak will look – and the character will seem just a little older . . .

The cape, of course, leaches age from those who wear it. The change should be very vague at first – even when the aging is detected, the cause shouldn't be immediately recognizable. After about a week, the character will be an old man . . . unless he rids himself of the cape.

The Acid Test Scabbard is an innocent-looking, well-tooled sword scabbard designed to fit a broadsword. At the very bottom of the scabbard is a thin bladder of acid, which will be punctured when a sword is thrust within. When the sword is re-drawn, the blade's condition will leave a lot to be desired.

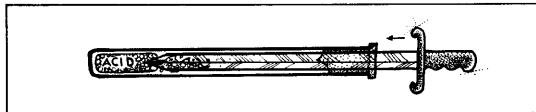

Item Traps

– NOTES –



Item Traps

– NOTES –

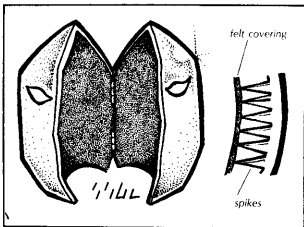

The Iron Maiden Helmet

is an item trap that leaves no room for mistakes. The trap takes the form of a velvet-lined helmet, constructed in two parts with a hinge in the middle to facilitate easy wearing. Beneath the velvet lining, however, is a field of sharp spikes – which will doubtless be discovered when the helmet is fully closed . . .



The Morningstar Supernova should provide a guiding light for those characters who feel that they can pick up just about any weapon they choose. This morningstar is built around a solid, explosive core; when a solid object is struck, the morningstar points will fire out in all directions with violence enough to make a hand grenade look like a cream pie by comparison.



Steve's final item trap is the **Double-Crossbow**. This crossbow is ingeniously designed so that it will fire its quarrels in the opposite direction from that which is expected – in other words, into the sighting eye of a delver. The crossbow comes equipped with a surreptitiously sharpened quarrel for just this purpose.

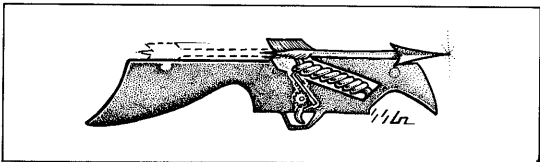

Ashley Morton decided he was tired of watching delvers loot the bodies of his dead monsters, so he designed the **Atomic Necklace**. The necklace chain is made of finely-wrought gold – beautiful enough to ensure that greedy dungeon delvers will want to make it their own.

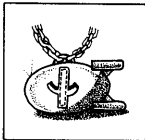

Attached to the chain is an inch-long charm shaped very much like a bomb. The necklace is designed such that if it is ripped from the body of a monster, the chain will tear apart at the bomb, pulling its pin and causing a detonation . . .

5

Things

What are “things”, you ask? “Things” are things, I reply. Things are peep-holes drilled into dungeon walls. Things are floors that aren’t, and eye-catchers that are. Things guard chests, masquerade as fountains, lie snug within dungeon walls and hide gleaming below dungeon floors.

Things aren’t just any old thing. Discover them at your own risk.

Buried in the mists of time lies a rather well-known dungeon where the monsters keep track of the delvers by peering through peepholes. The casualty rate among such beings is rather high, however, as the delvers within the aforementioned dungeon have long since learned to shove their blades into such holes, thus rendering the monster unfit for his lookout duties.

Rallying to the bellows of indignation this circumstance created, Johnny Green developed the **Sword Breaker**. The construction is very simple indeed, assuring that this trap is both reliable and taxing.



A one-way mirror has been installed behind the standard hole-in-the-wall. Behind this mirror stands a bloodthirsty and fearsome troll, his hands held ready upon twin triggers. Poised within the wall, set so as to be able to spring powerfully into the middle of the hole, sit two sharpened iron wedges.

When a delver looks through the hole, he sees the reflection of his own eyes looking back at him. The troll beyond the glass cannot be seen, due to the nature of the mirror – but the monster can certainly see the delver (and he'll probably drool with anticipation). Seeing "eyes" staring back at him, the delver will probably move quickly for his sword, then stab it deep into the hole in an effort to blind the creature beyond. When this happens, the troll releases the wedges, and *crack!* – the sword is broken.

If the delver uses his dagger instead, note that his elbow will probably pass into the wall at the point where the steel wedges usually meet. More's the pity.

Mike Stackpole has developed another way to deal with peeping toms. The **Eye-Catching Trap** is very similar in appearance to the "Sword Breaker" – but the consequences are far more horrible.



Set in a wall, perhaps partly hidden by intricate stonework, are two eye-holes. If a delver peers through them, he will see what lies in the room beyond. Fill the room with something that will interest the adventurer – anything from enemies to treasure to dancing girls should do the trick.

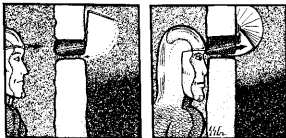

Inform the character that he can see a little of the room, but if he moved closer to the holes he could probably get a better view. After all, trying to peer through a small set of holes from a distance is something like looking through a telescope held some distance from the eye.

If the character moves in closer to get a better look, the pressure of his forehead against the stone wall will cause a section of the wall to move slightly, dislodging the spike on the other side of the hole to swing freely. The whole assembly will swing down into the eyes of the delver, with predictable results. For added cruelty, the pokers can be made of barbed wood that will easily break loose when the character jerks his head away from the hole in pain.

Another “thing” from Mike is the **Wall Wards**. This trap is designed prevent delvers from hacking through the dungeon walls, or converting them to mud without retribution.

The trap consists of a series of metal tubes, each containing a heavy spring. Within each tube is a crossbow bolt, depressed against the spring in such a way as to assure that it will be launched from the tube with great velocity, should the pressure on the spring ever be removed. The bolt is held into place by a concentration of concrete – the concrete of a dungeon wall . . .

When the wall is excavated, the tubes will thus become uncovered. The bolt will then fly from the tube, hitting any character in its line of flight. This trap works best when located in a wall that will almost certainly take abuse – such as the wall of a prison cell, or a wall that’s designed to slide in on a party to crush them to death . . .



Paul O'Connor has developed a pair of truly gruesome “things”. *Things* is really the only word for them – they certainly can’t be considered mechanical traps. In fact, the two traps may even be distantly related.

The first of these is the **Fountain Trap**. The thing appears to be a normal, everyday fountain. Its water is slightly murky, but gold coins can be seen to glimmer faintly at its bottom.

The fountain is, in reality, a living creature. An adventurer who touches this fountain or (perish the thought!) drinks from it will be quickly engulfed, with varying chances of avoiding certain doom, depending upon the circumstances. The “water”



is actually a digestive fluid, which can dissolve any substance but gold . . .

A character stuck in this thing is in a lot of trouble. A solo adventurer, without buddies nearby to rescue him, is almost certainly doomed.



Similar to the “Fountain Trap” is the **Floor Creature** – another biological horror. This creature lies on or slightly above standard dungeon floors. The creature’s natural coloration closely mimics the appearance of common stone. In short, the floor should appear normal, save for a slight “spongy” or “springy” feel.

When the creature feels pressure upon its hide, it will rapidly constrict into a ball. Characters standing on the creature have varying chances of jumping free, depending on how close to the edge of the room they stood. The “Venus Floor Trap” kills by constriction – again, it will probably take an entire group of characters to kill it, while those trapped inside can do nothing but scream.

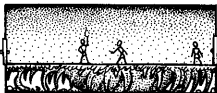

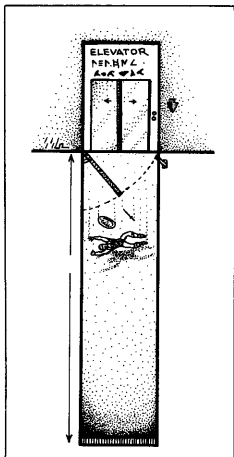

A grim trap, **Going Down?**, was submitted by Carl Muncy. This trap should convince the characters to take the stairs.

The trap appears to be a standard elevator – yet when the “Down” button is pushed (and it will be – it’s the *only* button on the control panel), the floor will fall away, and those standing inside the “elevator” will plummet into the dropshaft that lies below.

At the bottom of the shaft is a teleporter pad. After the character hits (and takes whatever damage is appropriate), the pad will teleport him back to the top of the shaft. If the character still has his wits about him, he might try to catch the rim of the shaft at this point. Otherwise, he falls back down again, starting the gruesome cycle over once more. Furthermore, the more damage a character is forced to endure, the slimmer will be his chances of grabbing the rim of the shaft and pulling himself to safety.

At the end of your rope? Then this next trap by Mike Stackpole and Paul O’Connor is just the thing to try out on the delvers in your dungeon.



Ariadne’s Revenge is a typical sucker trap. What delver wouldn’t reach for a wallet on the ground, even if he knew that it was attached to a wire designed to pluck it from his grasp? Likewise, what delver wouldn’t follow a thread of gold through the corridors of a dungeon, even though he knew there was no way it could possibly terminate in a huge spool of gold thread?

Simply present your characters with the end of a golden thread. The thread can meander through corridors, up and down stairs, through doorways and into pits. If the characters reel in the thread as they go, they might very well become lost. If they merely follow the line to its source, they’re in for a nasty surprise . . .

The thread, you see, is really a line of web from a Very Big Spider . . .



Brandon Corey is responsible for **Four on the Floor**. This fiend obviously gains great satisfaction from playing tricks on waitresses.

This trap will work anywhere you can put a table. Upon the table are located four glasses, each containing an opaque liquid of a different color as well as a precious gem or stone. Each glass is set on the table rim-down, so that the liquid within cannot leak from the glass.

The liquids are the trap. As a glass is broken or lifted from the table, the fluid within will spill out upon the table. The fluids, when intermixed, will cause a chemical reaction – one that produces a poisonous gas as a byproduct.



Ever get tired of watching characters open chests and such from a distance with a pole, thus avoiding all your careful traps directed at anyone trying to loot the treasures within? ? Scott Rhoads apparently did, and developed the following **Various Killers of Paranoids**. With each of these traps, the character who opened the chest is safe, but a person standing a respectable distance away is in trouble – and someone standing out of the room entirely is subject to an even worse fate. Still, I feel that these traps speak for themselves, thus:

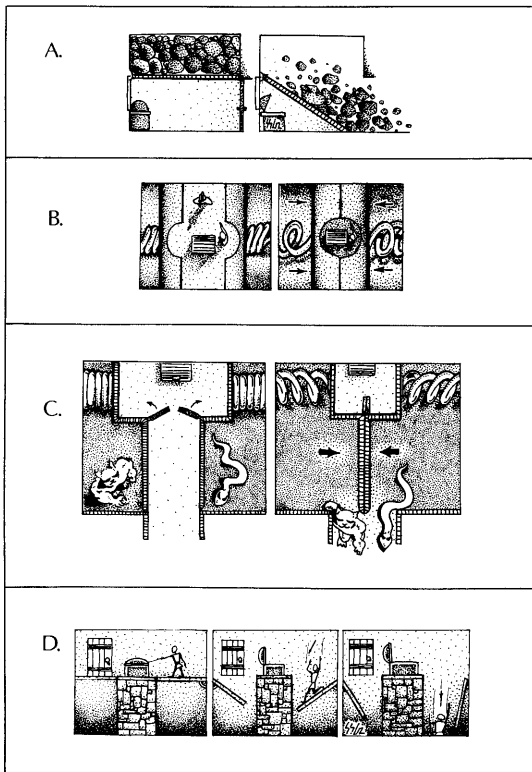

Things

– NOTES –



Mike Stackpole also contributed **A Hot Time In The Old Camp Tonight**. This trap can be located anywhere a convenient camp site is found – beyond the walls of an evil Lord's castle, upon a beach frequented by travelers, beside a well-trodden road, or upon a mountaintop visited by the adventurous.

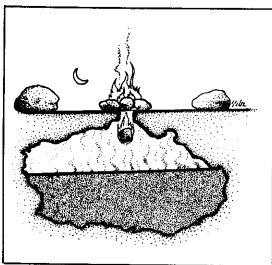

The trap is very simple in construction. In the center of a campsite is a ring of stones surrounding the ashes of a long-dead campfire. Beneath the ashes is a slab of hardwood. This wood probably won't be noticed unless the characters bother to wash away the firesite before using it.

When a fire is started here, the hardwood plank will begin to deteriorate. After a number of hours (probably in the dead of night, if the characters are camping here in earnest), the wood will burn through

completely, allowing the flames to lick through into the cavity beneath.

The cavity is mostly filled with oil; air and fumes fill the remainder. Coal from the fire above, falling into this oil, could easily trigger an explosion.



For Mike Stackpole, nothing is sacred. With **The Cranequin Goose**, Mike has put a trap where you would least like to find one.

In a public facility without internal plumbing – such as an outhouse or an open-pit toilet – a character will find a finely appointed stall. If this is set in a King's chambers, you might wish to pad the seat. In any event, if a character should decide to make use of the facility, he or she is in for an unpleasant surprise.

Any pressure upon the seat activates a crossbow located in the cesspit below. The resultant “goosing” effect can range from being comical to fatal, depending upon your mood. A fine way for a high and mighty hero to die, don't you think?



E.L. Frederick has developed a different sort of “thing” trap: **The Graffiti Demon**. Legend is full of demons and other ethereal beings which are summoned to the mortal plane by various phrases and incantations.

If you take this principle one step further, you could easily develop demons that appear when a delver says something like, “Open the door!” or “This Gold's Mine and You Can't Have It!” Perhaps even reading otherwise forgettable graffiti on a dungeon wall could summon a demon called “For a good time call Snuggles the Elf”.

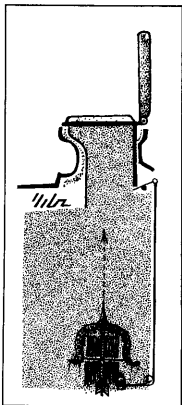

The 101st Trap

101st Trap

– NOTES –

As a postscript to my collection of traps, I offer you, dear reader, a sample from my own personal stock of delver destroyers. This is a rare moment indeed – never before has one of my traps seen the light of day beyond my own personal cesspit, where only the foolish and the death-doomed have thus far ventured. Still, the publication of this tome of traps is itself a rare thing, and is thus deserving of such a final performance.

Wizards are a nosy breed, and will often probe and poke about in places where they have no business. I suppose that I cannot blame them for this – a wizard's nature is every bit as inbred as a sheep's – but it still sets my blood ablaze to learn that some pesky magicker has been reading through my personal effects in search of some new and esoteric bit of thaumaturgical knowledge. In the eyes of a power-hungry mage, every dusty book on the dungeon shelf is a volume of spells – even if it is merely a collection of phone numbers of favored companions. Positively deplorable.

Thus, I developed the trap which I now reveal to you here.

The preparation of this trap was a long and trying one. I had to search the world over to find the precise ingredients required by my plans. Everything had to be just so.

After a year of careful searching, I had compiled the necessary ingredients. The ink of the rare Purple Devilfish. A tuft of hair from a blind gibbon with no lungs. The wishbone of a duck. The intangible innocence of a newborn babe. These and other items I then mixed in a great vat, shuttered away from prying eyes in the deep recesses of my pits. Accompanied by the tolling of an iron bell, I uttered the words of the softly-spoken magic spells. A moment of cosmic tension – then, finally, the deed was done.

The resultant potion was a clear odorless one that proved undetectable when spread upon most any surface. It dried to a thin, almost filmy consistency within a few moments. This film would remain undetected on the surface to which it had been applied until such time as human hands touched it. The oils secreted by human skin, you see, interact violently with the potion when the two come into contact. This results in the film regaining viscosity in the form of a fast-acting neurotoxin contact poison. The poison enters the victim's body in a matter of seconds. Painful death usually follows within a few minutes.

As a demonstration, I've taken the liberty of coating this page with a measure of this potion. By now, the poison should be well within your system. By my calculations, you should have just enough time to replace this book on the shelf where you found it before you pitch over in frothing fits.

Next time around, remember your station and keep your nose out of books that are none of your business.

And your dreams.

– Grimtooth



Credits

List of Contributors

Lara Abrash (p. 28)
Michael Austin (pp. 8, 9, 10, 43, 44)
Harley Bates (p. 41)
James Brazier (p. 32)
Brandon Corey (pp. 8, 18, 26, 50)
S.S. Crompton (pp. 33, 41, 44, 45, 46)
Liz Danforth (pp. 30, 35, 39, 42, 43)
Todd Diesen (p. 7)
Oliver Fittock (p. 32)
E.L. Frederick (p. 52)
Johnny Green (p. 48)
John R. Greer (p. 23, 29, 32)
Grimtooth (p. 53)
Stefan Jones (p. 21, 40)
Charles Scott Kimball (pp. 13, 40)
Betty Kopf (p. 3)
John Longenbaugh (pp. 24, 28)
Rick Loomis (pp. 7, 13, 25, 26, 33)
Jason Lujan (p. 21)
Maughn Matsuoka (p. 14)
David McConnell (p. 15)
Ashley Morton (p. 46)
Pat Mueller (pp. 4, 30, 32)
Carl Muncy (p. 50)
Paul O'Connor (pp. 2, 4, 5, 20, 24, 40, 49, 50)
Mark O'Green (pp. 29, 30)
Scot Rhoads (pp. 7, 13, 51)
Edward Schoonover (pp. 29, 30)
Michael Stackpole (pp. 7, 16, 17, 19, 28, 34,
35, 38, 39, 44, 48, 49, 50, 52)
Ken St. Andre (p. 42)
Barry Sullivan (p. 12)
J. Sutherland (p. 27)
Jim Walker (p. 19, 22)
Uriah Ward (pp. 26, 43)

Executive Producer
Rick Loomis

Produced by Paul O'Connor

Directed by Liz Danforth

Special Effects by Steven S. Crompton

Design and Layout by Pat Mueller

Grimtooth's makeup by Liz Danforth

Sound Effects by Michael Stackpole

Post-Production Editing by Pat Mueller

Printed by Associated Lithographers
film by Compugraphic titles by Letraset

Typso by Pat Mueller

Accuracy by Jim "Wa-hoo" Cooper
Continuity by Jason Sato

"Post" Production Work by
Ugly John Carver and Debbie Cady

Live action sequences by the Trolls
at Tom & Jerry's Wallball Palace

Formula I racing by Herman Muskankowitz

Wandering Monsters
Steve MacGregor and Jim Walker

Assistant to the Producer
Thessaloniki Canotas

Cataloging by Ken St. Andre

Key Grip
Allen Nordendale

Gaffers
Edward Schoonover and Chuck Gaydos

Overseas Correspondent
Chris Harvey

A Grimtooth Production
a subsidiary of Blade
a division of Flying Buffalo Inc.

HEROIC FANTASY

*a new concept in
play-by-mail gaming*

Magic and mayhem ... and lots of excitement!
Your hand-picked crew of warriors and wizards
explores a multi-level labyrinth
strewn with glittering treasure
that's guarded by hordes of
slaving monsters – and
other adventurers!

- ✓ Completely computer-moderated
- ✓ A multi-player game
- ✓ Run by the only pbm game company that's been in the business for 12 years – serving thousands of satisfied customers around the world!
- ✓ If you have access to a computer with a modem, you can send and receive your game turns by electronic mail!

For the rules to **Heroic Fantasy**, send \$1.00 (in US funds) and the coupon below to Flying Buffalo Inc. (Please do not request a game until you have read the rules.)

Name _____

Address _____

City _____ State _____ Zip _____

Flying Buffalo Inc.
Dept. GT-5 • P.O. Box 1467
Scottsdale, AZ 85252

- check here for a free copy of our catalog of fantasy and science fiction games

Copyright © 1982 by Flying Buffalo Inc.

illustration by Chris Carlsson



The Adventures Begin!

LEJENTIA

CAMPAIGN BOOKS

A complete fantasy world campaign for all role-playing systems

The powerful forces of the Tarin Tor and the outnumbered armies of the Elven Republic have been at war for centuries. Through arcane Magicks, Hellish Allies and sheer numbers, the Tarin Tor have been taking both Human and Elven lands in their southward march of conquest.

Your campaign begins in Skully's Harbor, a wild river town that is on the border between The Tarin Tor Lands and the Elven Republic. An uneasy truce exists between the two Armies on both sides of the River but at any time, the forces of the Tarin Tor may descend upon Skully's Harbor and sweep it away.

Will your players work for the Tarin Tor, the Elves or any of the many characters who live and work in Skully's Harbor? Will they discover the secret power that keeps the town safe? The answers lie within these pages.

Lejentia Campaigns Book One: Skully's Harbor is the first in a series of Catalyst gamebooks based on the Lejentia Graphic Novel series. Usable with all role-playing systems, the book contains a fully described and mapped town, world map and cultures description, over 50 non-player characters, & 75 different scenerios — everything you need to start your own Lejentia Campaign!

OTHER BOOKS IN THE SERIES:

Lejentia Stanza Adventure Pack S1
Lejentia Campaigns: Book 2 Fort Bevis
Lejentia Stanza Adventure Pack S2 and more!



© T.F. Compton

Task Force
All-System

Catalyst
Series

All-System Catalyst Books

Many of you have been asking us "Just which books can I get in the Catalyst line?" So in answer to your pleas for help, here is a list of the available Catalyst books you can order from your local store or distributor. Many of these are in short supply, so get your orders in.

The classics - Grimtooth's Traps & Citybook! What can we say? these books just keep on selling and selling. If we stopped making them, hordes of angry customers would descend on us in protest!

GRIMTOOTH'S TRAPS - \$9.95: The first book of 101 deadly devices and sinister snares, from the grimly cheerful claws of the great Troll, Grimtooth himself - delvers beware! Complete with room traps, corridor traps trapped items and more! Product # 8501

GRIMTOOTH'S TRAPS TOO - \$9.95: 101 more engines of evil and bemusement for the befuddled and unwary. Door traps, monster traps, more room and corridor traps. Plus - Secret codes and messages galore! Product # 8502

GRIMTOOTH'S TRAPS TREE - Not Available! These traps were so horrible, an unnamed governmental agency bought up all copies, firebombed the printer and forcibly drafted all the authors. (unavailable at any price)

GRIMTOOTH'S TRAPS FORE - \$9.95: Yet another 101 precarious pitfalls and depraved deceptions for the unlikely and unknowing. The Troll strikes again with more room, item, door and corridor traps. This book has just been expanded and updated! (See article for info) Product # 8504

GRIMTOOTH'S TRAPS ATE - \$9.95: Our biggest book yet! 100 artifacts of annihilation and mechanisms of misfortune. (There is no 101st trap - really!) Special "food" chapter and the much awaited Grimtooth's Scrapbook. Also meet Grimtooth's sister - Grimtina! A must for all Traps fans. Product # 8508

CITYBOOK I: Butcher, Baker, Candlestick Maker - \$14.95: 25 detailed businesses, many colorful NPC's and over 70 supplemental adventures for city-based scenarios. After you have created your own citymap, use these businesses to fill in the spots where you have a "building". Citybook I received the HG Wells Award for Best Role-Playing Supplement at Origins 1983. Product # 8511

CITYBOOK II: Port O' Call - \$11.95: Over 20 businesses and services for seaport cities, mariners or every sort can find excitement and adventure. Each establishment is complete with detailed maps, fully developed NPC personalities, and over 60 suggested scenarios. "The Longtooth Lounge" was written by Dave Arneson, co-designer of D&D. Product # 8512

CITYBOOK III: Deadly Nightside - \$11.95: 18 detailed businesses and establishments in the seedy part of town, where your most likely to be caught dead! 36 suggested scenarios, and over 60 fully-developed NPC personalities. Product # 8513

CITYBOOK IV: On the Road - \$11.95: 13 new establishments and transportation operations. With 23 NPCs, each an adventure onto themselves. Travel the highways and byways of your world in this latest in the series. Take note; Citybook V is being worked on. Product # 8514

If you already have some of the Citybooks, then you've got to try out one of our Campaign Books! These books are set in Lejentia, a unique fantasy world that can readily be adapted as the background in which your game takes place, or an entirely new world for players to explore!

Campaigns Book 1: Skull's Harbor - \$14.95 Contains a fully described and mapped town, world map, over 50 NPC's and 75 different scenarios, in Citybook style. The first section of the book details new races, magic spells and in-depth description of the world of Lejentia. White Wolf mag. gave this book a four star rating! 160 pgs. Product # 8551

Campaigns Book 2: Fort Bevits - \$14.95 Filled with villains, dark elves, and insectoid creatures called Novilles, Fort Bevits is a fully described fortress and caverns with over 50 illustrated NPCs, 71 detailed scenarios and over 20 maps of the fort and surrounding territory. Plus a 40 page intro section which details the politics, powers and culture of the Tarin Tor Army. Product # 8553

Lejentia Adventure Pack S1: - \$9.95 Details the creatures, characters and places from the Lejentia comic book (which is included) Also has an 11 x 17 city map, full color map of the world of Lejentia and 24 page book detailing places and scenarios. Product # 8552

Also available in the Catalyst Line:

Treasure Vault: - \$6.95 A collection of 26 unusual items (magical and otherwise) with 38 interlocked personalities in 57 suggested scenarios. From the Golden Owl of Ilgen to Mordin's Mystical Mirror, every unique item is worthy of a adventurer's quest! Done in Citybook style. Product # 8520

Wilderness Encounter Book - \$9.95 Adventures outside the relative safety of the city walls with this new book. 13 outdoor adventures, from the tomb of the Vashcari, to the Giant Wasps nest, and many others. All mapped, illustrated and planned out. Product # 8561
If you can't get these books at your local game store, you can order them direct from the publisher. Include \$1.00 per order extra for postage and send check or money order to:
Flying Buffalo Inc. P.O. Box 1467, Scottsdale, AZ 85252
New Catalyst books will be released soon!

Why are you **roll**-playing
when you can **role**-play with

TUNNELS & TROLLS

If you're just getting into Fantasy Role-Playing ... if you want to try something different ... or especially if you'd like an easy option to play solitary FRP ... you'll really want to look into **Tunnels & Trolls**.

Reviewers are raving about T&T's speed and ease of play. We're the second-oldest FRP game system around - and our rules are still complete in one book! The rulebook contains everything you'll need to know to play, in clear, easy-to-understand text.

We also produce a complete line of T&T solitary adventures, game master adventures.

Write for our free catalog!

*Tunnels & Trolls is found at
better book and hobby stores.*

*Or, to order direct, send
\$15.95 for the boxed set.*

FLYING BUFFALO
P.O. Box 1467
Scottsdale, AZ
85252

(please include \$1 for
shipping and handling)

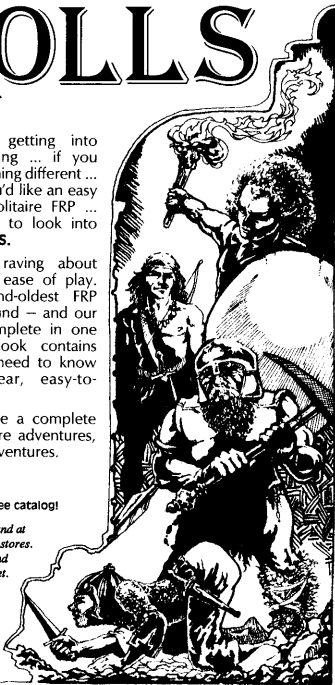



Assembled herein are one hundred and one catastrophic traps, sinister snares, engines of evil, and deadly devices, with passing comments made on a folio of fearsome fates . . . in all, one hundred and one ways to influence delvers, tunnelers, and all player characters.

The traps within this book have been presented *without* game mechanics of any kind; the nature, cause, and effect of each trap has been thoroughly described so that any GM may introduce these devices of delver destruction into his or her games with ease. For example:

Figure A. a seemingly straight corridor



Figure B. suddenly becomes a drop-shaft!

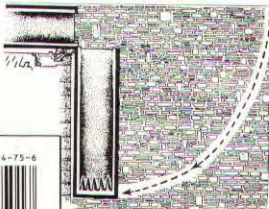

The See-Saw Corridor is an especially fiendish corridor trap that could prove to be the death of even the toughest characters.

The trap works best in unlit corridors, to conceal the spikes that will eventually lead to the delvers' doom. A significant amount of weight must move past the pivot point to trigger this trap. In a matter of seconds, the corridor that had provided safe passage becomes a deadly drop-shaft! The specifics of the damage caused by this trap are, of course, left to the Game Master, but the compounded menace of a long fall and impalement will probably do most characters in.

Produced by
Flying Buffalo



ISBN 0-940244-75-6 #8501

ISBN 0-940244-75-6



7 24903 08501 7