

Advanced Dungeons & Dragons  
2nd Edition

DARK SUN™

W O R L D

Official Game Adventure

Astician Gambit

by Anthony Pryor





# DARK SUN

W O R L D

Pawns  
of the  
sorcerer-  
kings

Player's Book



## Astician Gambit

A DARK SUN™ Campaign Adventure

### Player's Book

#### Credits

Design: Anthony Pryor  
Editing: Timothy B. Brown with Michele Carter  
Cover Art: Brom  
Interior Art: Tom Baxa  
Typography: Gaye O'Keefe  
Cartography: Steve Beck  
Graphic Design: Dee Barnett & Sarah Feggstad  
Graphic Production: Laura Samuels

This material is protected under the copyright laws of the United States of America. Any unauthorized use of the material or artwork contained herein is expressly prohibited without the written consent of TSR, Inc. Copyright ©1992 TSR, Inc. All Rights Reserved. Printed in the U.S.A.

Random House and its affiliate companies have worldwide distribution rights in the book trade for English language products of TSR, Inc. Distributed to the book and hobby trade in the United Kingdom by TSR Ltd. Distributed to the toy and hobby trade by regional distributors.

ADVANCED DUNGEONS & DRAGONS and AD&D are registered trademarks owned by TSR, Inc. DARK SUN and the TSR logo are trademarks owned by TSR, Inc.

All TSR characters, character names, and the distinctive likenesses thereof are trademarks owned by TSR, Inc.

TSR, Inc.  
POB 756  
Lake Geneva  
WI 53147  
U.S.A.



TSR Ltd.  
120 Church End  
Cherry Hinton  
Cambridge CB1 3LB  
United Kingdom

Two:  
The Queen is Displeased



Three:  
Spunt the Jester



Four:  
Sylos the Merchant



Five:  
Nibeni Warriors



BOSS 92

Six:  
Waylaid Thri-kreen





## Seven: Nibenay



Nibenay—Home of the mysterious Shadow King. It is a vast, walled city, full of buildings covered in bizarre reliefs. Substantial rice paddies lie all around and even within the city itself, tended by legions of slaves and their grim Mul overseers.

Nibenay seethes with activity. Ordinary citizens hurry from place to place under the watchful eye of the Shadow King's warriors. Slaves haul goods for merchants, while *crodlu* and *inix* crowd the streets, carrying cargo, both living and nonliving. Templars walk past the ornate buildings, swaggering confidently. To your surprise, you realize that all of the Nibeni templars are women.

You put this down to the infamous eccentricity of the Shadow King, who rarely ventures from his vast walled palace near the center of the city. In the distance, you see the king's compound. In the center is a vast carving—the bust of a grim, dangerous-looking man.

"See?" says a templar, pointing. "That is the head of our sacred and beloved Shadow King. No mere mortal may enter his inner sanctum."

Eight:  
B'rohg



## Nine: Gulg



To an adventurer who has spent most of his days in the lifeless desert, or in the dusty villages and city-states of Athas, Gulg is a wonder to behold. Rising from the Crescent Forest, the city sits amid lush greenery and tall agafari trees. There is water enough here to keep such a forest healthy—indeed, the water seems to invigorate the very air, for it is both hot and humid here.

You gaze in awe at the thick thorn hedge that surrounds the city granting as much protection as any city wall. Gulg's templars—tough, fierce looking warriors with spears and clubs—wave you through and guide you to the place where the caravan's cargo will be unloaded.

The people seem surprisingly content, living as they do under the thumb of a sorcerer-monarch. All seem well-fed, and even the slaves have a certain vitality lacking in other city-dwellers. You pass by many homes crafted of mud and roofed with thatched vines. A templar approaches you and points toward the center of the city, where a gigantic agafari tree bears in its branches a gleaming, white palace.

"You are to come with me," he says. "You bear a gift for our blessed ruler, Lalali-Puy. She requests your presence at her palace."

Ten:  
Yandor of the Bow

Box 692.



Eleven:  
Anakore Attack

83<sup>22</sup>



Twelve:  
The Vault

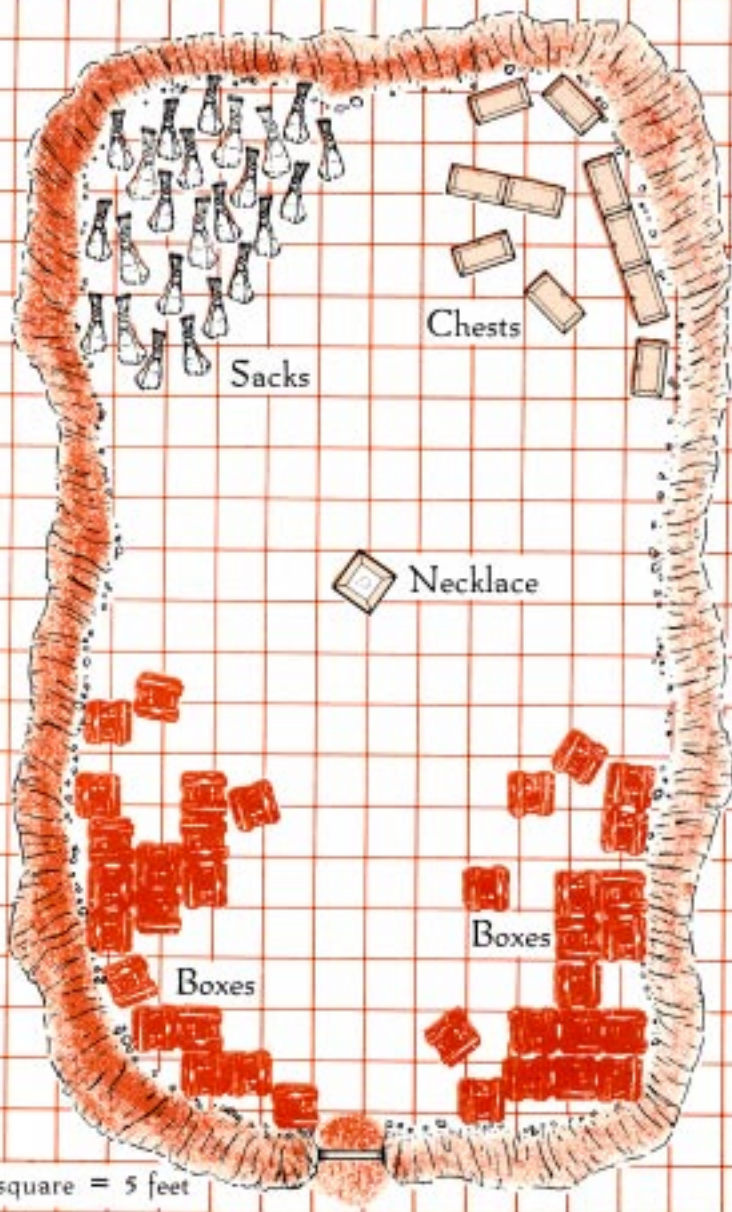

Thirteen:  
Warikari Redeye



Fourteen:  
Mogadisho





Fifteen:  
Renegade Halfling



Sixteen:  
Bog Wader



Seventeen:  
Gulg Palace



Eighteen:  
Sempronius of Asticles



Nineteen:  
T'Kkyl

**Thri-Kreen Gladiator**  
**8th Level**  
**Lawful Neutral**

Str 15  
Dex 19  
Con 17

Int 14  
Wis 13  
Cha 15



Twenty:  
Anavias of the Split Rock

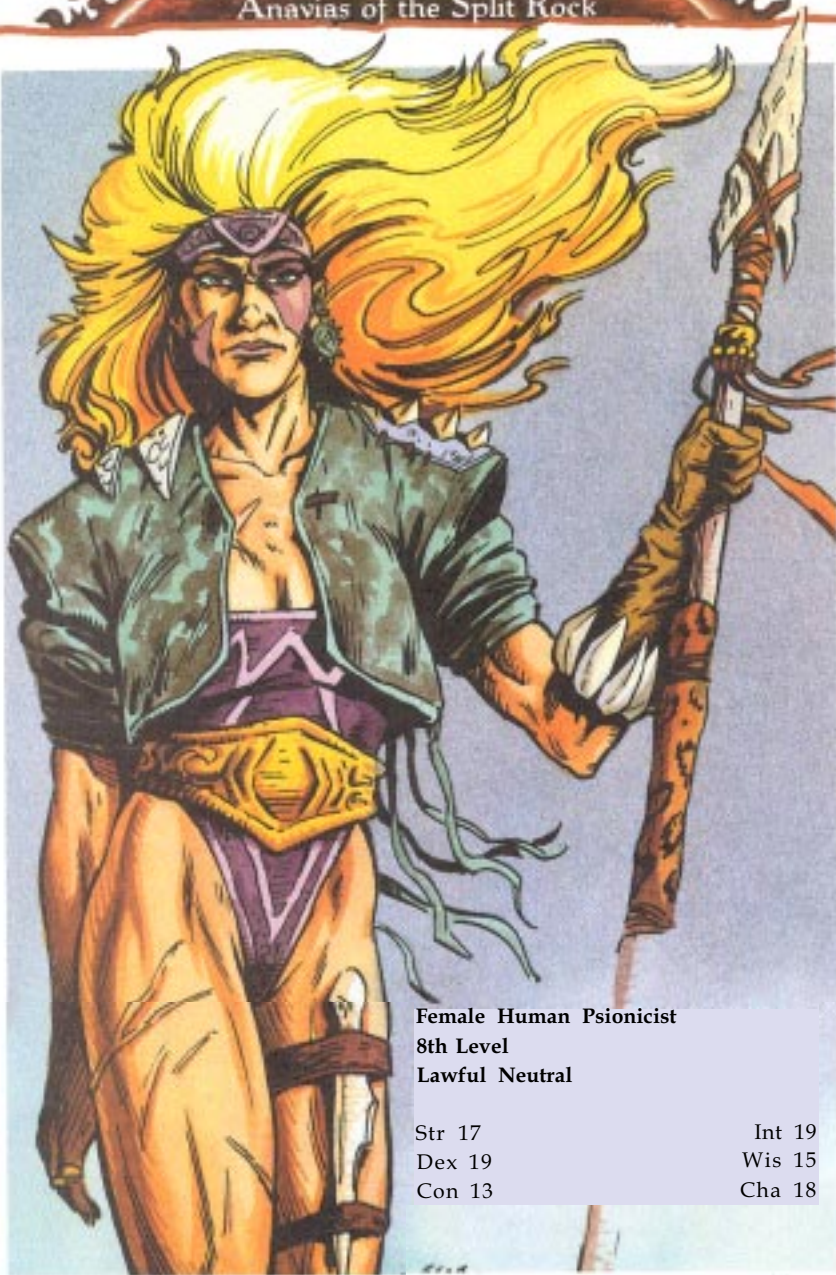

**Female Human Psionist**

**8th Level**

**Lawful Neutral**

Str 17

Dex 19

Con 13

Int 19

Wis 15

Cha 18

Twenty-One:  
Vaerhirmana

Female Half-Elf Fighter/Preserver  
6th Level/6th Level  
Chaotic Good

Str 17

Int 15

Dex 17

Wis 12

Con 16

Cha 15



Twenty-Two:  
Herminard the Eloquent

Male Human Bard  
9th Level  
Neutral Evil

Str 12  
Dex 18  
Con 11

Int 15  
Wis 10  
Cha 17

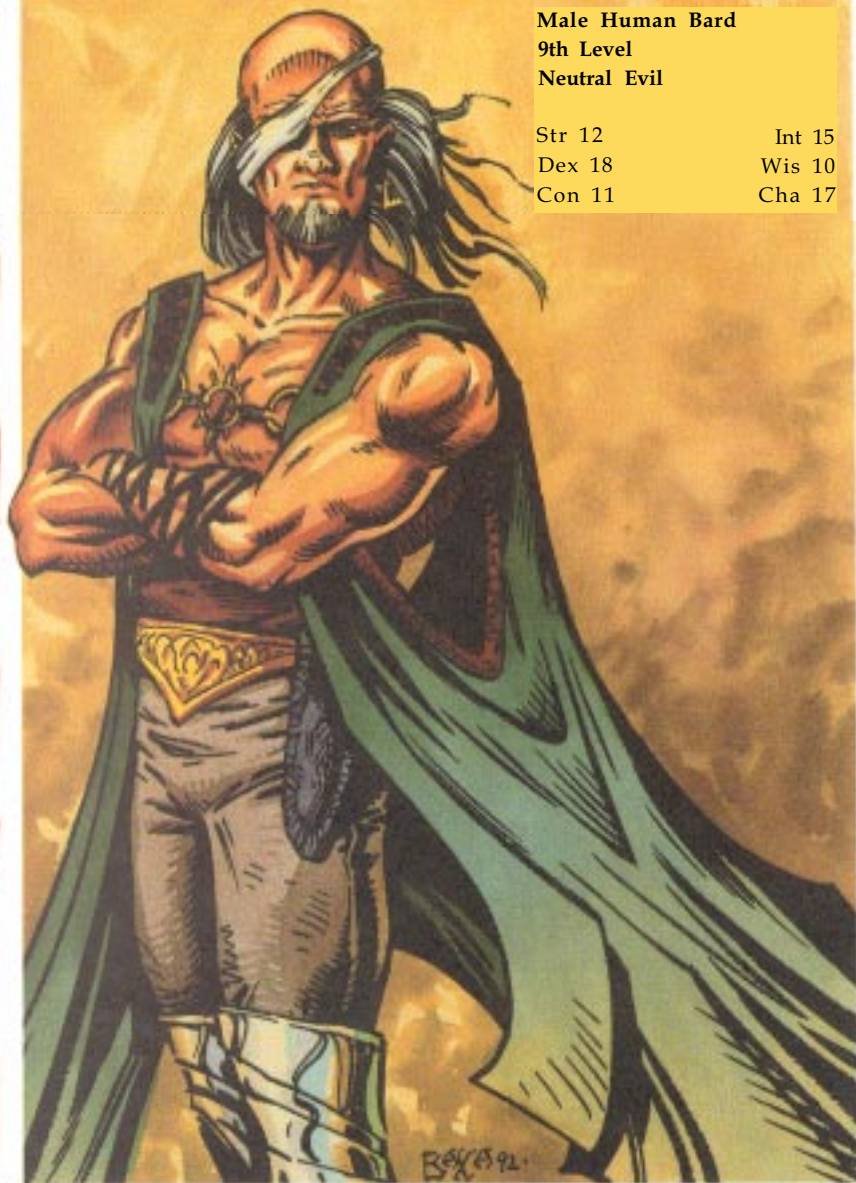



Twenty-Three:  
Azul the Hasty

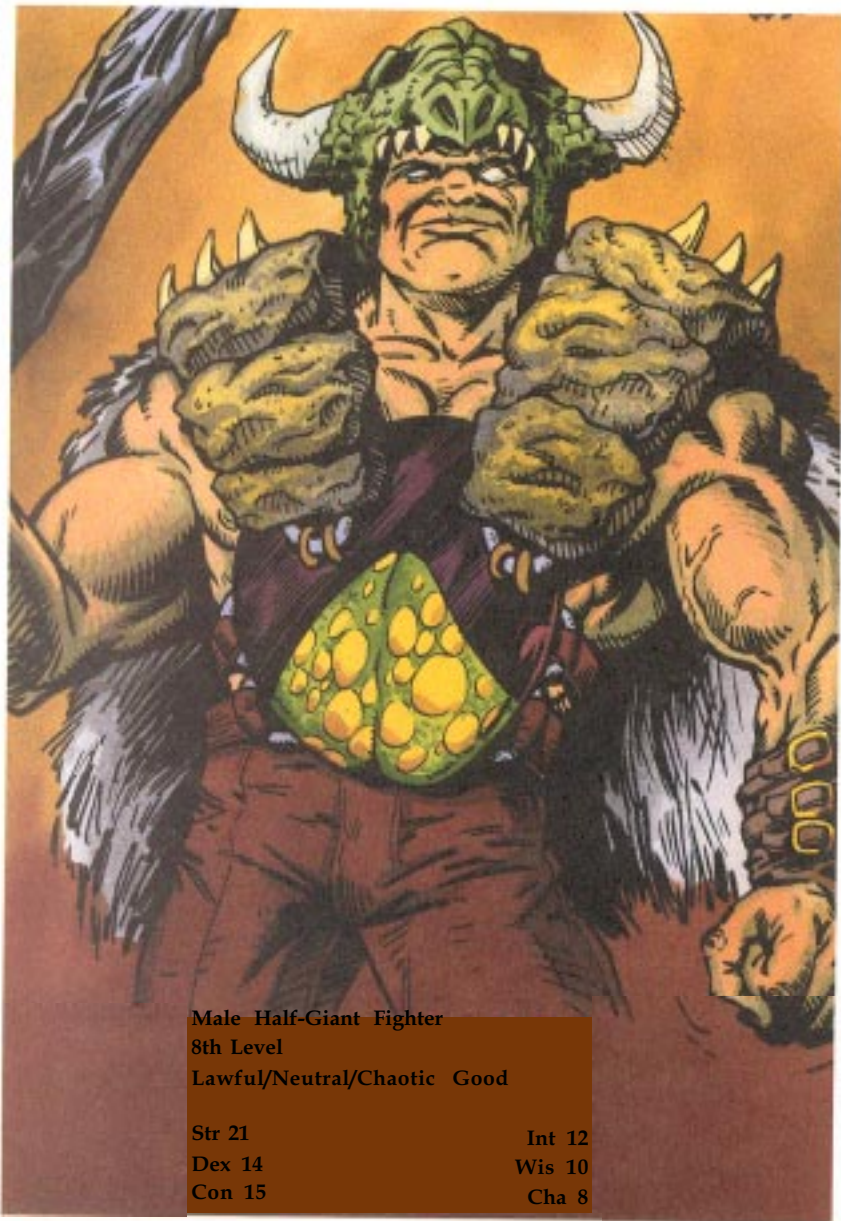

Male Half-Giant Fighter  
8th Level  
Lawful/Neutral/Chaotic Good

Str 21

Dex 14

Con 15

Int 12

Wis 10

Cha 8

Twenty-Four:  
Chivald

Male Halfling Cleric/Psionicist  
6th Level/6th Level  
Neutral Good

Str 15

Int 17

Dex 19

Wis 16

Con 15

Cha 16



## Twenty-Five: Chivald (Cont.)

**Reaction Adjustment:** surprise +3  
NPCs +5  
#AT 1; THAC0: 18;  
Bone Spear, -1 to hit, +3 thrown  
Obsidian Hand Axe, -2 to hit, +3 thrown  
Damage: Bone Spear 1d6-1/1d8-1  
Obsidian Hand Axe 1d6-1/1d4-1  
AC: 6/4 in leather armor (modified for Dexterity)  
Hit Points: 38  
Cleric of Air Spells: Five 1st-level spells  
Five 2nd-level spells  
Two 3rd-level spells

Prim/Sec: Psychoportation/Telepathy  
Sciences:

*Banishment* (Int -1, IC 30, MC 10/rd, R 5 yds)

*Mindlink* (Wis -5, IC contact, MC 8/rd, R unlimited)

*Teleport* Int, IC 10+, R infinite

Devotions:

*Astral Projection* (Int, IC 6, MC 2/hour)

*Contact* (Wis, IC varies, MC 1/rd, R special)

*Dimensional Door* (Con -1, IC 4, MC Yrd, R 50 yds+)

*Dimensional Walk* (Con -1, IC 8, MC 4/turn, R na)

*Dream Travel* (Wis -4, IC 1/25 miles, R 500 miles)

*ESP* (Wis -4, IC contact, MC 6/rd,

R unlimited)

*Identity Penetration* (Wis -3, IC contact, MC 6/rd, R unlimited)

*Life Detection* (Int -2, IC 3, MC 3/rd, R 100 yds)

*Teleport Trigger* (Int +1, IC 0, MC 2/hour, R infinite)

*Time Shift* (Int, IC 16 + special, R 0)

*Time/Space Anchor* (Int, IC 5, MC 1/rd, R 0)

Defenses: Intellect Fortress, Mind Blank, Thought Shield

PSP: 79

Saving Throws

D	M	RSW	PP	BW	Sp
9		13	9	15	14

Weapon Proficiencies: club, hand axe, spear

Non-Weapon Proficiencies: *Harness Subconscious, Healing, Heat Protection, Herbalism, Leatherworking, Meditative Focus, Rejuvenation, Sign Language, Somatic Concealment, Water Find*

Languages: Halfling, common

Equipment: bone spear, leather armor, obsidian hand axe; backpack, bag of carved casting sticks, 10 globes of kank honey, seeds of the home tree

Money: 5 cp (Chivald sees no need for money)

### Background

A minor indiscretion resulted in your mission—to seek wisdom for the tribe in the lands of the humans. Chief Hut, who sentenced you to this fate, was generous, allowing you to take his best casting sticks with you.

Your adventures in Tyr and Urik brought much new knowledge and wisdom regarding the outside world, and your adventures in the desert challenged your skills to their utmost. Yet, it is still not time to return to the tribe. You remain with your strange companions—for whom you have developed some fondness despite their offensive habits. You will know when the time comes to return.

## Twenty-Six: Azul (Cont.)

Reaction Adjustment: surprise 0

NPCs 0

#AT 3/2 (2/1 with two-handed sword)

THAC0: 13, +4 due to Str;

Bone-studded gauntlet, -1 to hit

Obsidian two-handed sword, -2 to hit, +1 specialization

Sling, no modifiers

Damage: Bone-studded gauntlet  
1d3+8

Obsidian two-handed sword

1d10+10/3d6+10

Sling stones 1d4/1d4

AC: 10/6 in braxat hide armor (no Dexterity bonus)

Hit Points: 84

Wild Talent: Catfall

Power Score: Dex -2

Cost: 4

PSP: 32

Saving Throws

D M	R S W	P P	B W	S p
-----	-------	-----	-----	-----

10	12	11	12	13
----	----	----	----	----

Weapon Proficiencies: mace, short sword, sling, spear

Weapon Specialization: two-handed sword

Non-Weapon Proficiencies: Animal Lore, *Armor Optimization*, Endurance, *Heat Protection*, Stonemasonry, *Water Find*, *Weapon Improvisation*

Languages: Common

Equipment: bone short sword, bone studded gauntlet, braxat-hide armor, obsidian two-handed sword, sling, pouch with 40 stones, stone-headed mace; fire kit, leather backpack (to size), 50' hemp rope, map case, tent (to size), 5 waterskins

Money: 1,800 cp

### Background

Although you were born near the Ringing Mountains, your life has been recreated so many times that you scarcely remember the lands of your birth. After serving the tyrant Kalak as a city guard you fell in with a band of adventurers, helping them save Tyr from invasion, and following them into deadly peril in the desert. Today, your role as adventurer seems to suit you well. You feel far more freedom than you did in Tyr, and as yet you feel no need to move on to yet another life. Time will tell, however, for yours is a changeable race, and no one really knows what the future holds.

## Twenty-Seven: Herminard (Cont.)

Reaction Adjustment: surprise +2  
NPCs +6

#AT: 1

THAC0: 17;

Bone wrist razor, -1 to hit

Chatkcha, +2 to hit (Dex)

Sling, +2 to hit (Dex)

Damage: Bone wrist razor

1d6-1/1d4-1

Chatkcha 1d6 +2/1d4+1

Sling stone 1d4/1d4

AC: 6/4 in leather armor (modified for Dexterity)

Hit Points: 35

Wild Talent: Time/Space Anchor

Power Score: Int

Cost: 5/1 per round

PSP: 41

Thieving Percentages

P P	O L F / R T	M S
75	45 15	50

HS	HN	CW	RL
50	20	65	15

Influence Reactions: -3 die modifier

Inspire: +1 THAC0, +1 Saving Throw, or +2 Morale

Identify Magical Item: 45%

Poisons Known:

B (Injected, Onset: 2-12 min., Str 20/1-3)

C (Injected, Onset, Str 25/2-8)

E (Injected, Onset: Immed., Str Death/20)

G (Ingested, Onset: 2-12 hrs., Str 20/10)

I (Ingested, Onset: 2-12 Min., Str 30/15)

J (Ingested, Onset: 1-4 Min., Str Death/20)

K (Contact, Onset: 2-8 min., Str 5/0)

Musical Instrument: Balician Lyre

Saving Throws

D M	R S W	P P	B W	S P
1 1	1 0	1 0	1 4	1 1

Weapon Proficiencies: chatkcha, dagger, sling, wrist razor

Non-Weapon Proficiencies: Appraisal, Disguise, Etiquette, Heraldry, Local History, Reading Lips, Read/Write Common, Ventriloquism

Languages: Common, elven, halfling

Equipment: bone hook, bone wrist razor, chatkcha, pouch with 40 stones sling; thief's tools, 80' ball of twine, belt pouch, 4 glass vials, various herbs (for poisons), Balician lyre

Money: 1,100 cp

### Background

You often wonder why you ever left the comfort of Balic to follow the life of a rootless adventurer. Of course, the angry templars and the price on your head probably had much to do with your departure, but you do not give such things much thought. You only joined up with this band of tattered wanderers for the safety and security they provided, and this has recently been minimal at best. Despite the fact that their interests and yours have run parallel for some time, you still feel the need to seek out another patron—someone who truly appreciates the skills of one of the finest bards on Athas.

## Twenty-Eight: Vaerhirmana (Cont.)

Reaction Adjustment: surprise +2  
NPCs +3

#AT: 1, 3/2 with bastard sword

THAC0: 15; +1 due to Str

Javelin, +2 to hit (Dex)

Obsidian bastard sword. -1 to hit  
(+1 spec.)

Short bow, +2 to hit (Dex)

Stone club, -1 to hit

Damage: Javelin 1d6-1/1d6-1

Obsidian bastard sword,  
one-handed 1d8/1d12 (+2 spec.)  
two-handed 2d4/2d8 (+2 spec.)

Bone arrows 1d6-1/1d6-1

Stone club 1d6-1/1d3-1

AC: 7/6 with shield (modified for Dex-

Hit Points: 36

Wild Talent: Hear Light

Power Score: Wis -3

Cost: 6/3 per round

PSP: 38

Spells: Four 1st-level spells

Spell Book

### 1st Level

Change Self

Detect Magic

Enlarge

Magic Missile

Phantasmal Force

Read Magic

Shield

### 2nd Level

Scare

Summon Swarm

Web

Wizard Lock

Two 2nd-level spells

Two 3rd-level spells

Saving Throws

DM	RSW	PP	BW	Sp
11	11	12	13	12

Weapon Proficiencies: Club, javelin,  
short bow, short sword;

Weapon specialization: bastard sword

Non-Weapon Proficiencies: Ancient  
History, Animal Lore, *Armor Optimi-  
zation*, *Heat Protection*, *Psionic Detec-  
tion*, Survival (stony barrens), Somatic  
Concealment, Weapon Improvisation  
Languages: Common, giant, thri-kreen

Equipment: obsidian bastard sword,  
quiver with 20 bone-tipped arrows, short  
bow, stone club, wooden javelin, hide  
shield; backpack, bone map case  
(spellbook), bottle of ink, 43' of rope, 4  
sheets of papyrus, quills and quillcase, 3  
waterskins

Money: 1,300 cp

### 3rd Level

Invisibility, 10' Radius

Lightning Bolt

Slow

### Background

After the death of your old master at the hands of intolerant humans, you fled to Tyr, where you were captured and thrown into the slave pits. The destruction of Kalak brought freedom, but little else, for prejudice and hatred were still rife all across Athas.

Your companions are a help to you, for they are a motley bunch who realize that appearances and ancestry are far less important than a good heart (well, most of

## Twenty-Nine: Anavias (Cont.)

Reaction Adjustment: surprise +3  
NPCs +7

#AT: 1

THAC0: 17; +1 due to Str

Bone dagger, -1 to hit, +4 thrown  
Dex)

Bone spear, -1 to hit, +4 thrown  
(Dex)

Stone club, -1 to hit

Damage: Bone Dagger 1d4/1d3

Bone spear 1d6/1d8

Stone club 1d6/1d3

AC: 6/4 in leather armor (modified for  
Dexterity)

Hit Points: 29

Primary/Secondary:

Psychokinesis/Telepathy/Clairensience  
Sciences:

*Aura Sight* (Wis -5, IC 9, MC 9/  
rd, R 50 yds)

*Mindlink* (wis -5, IC contact, MC  
8/rd, R unlimited)

*Project Force* (Con-2, IC 10, R 200  
yds)

*Telekinesis* (Wis -3, IC 3+, MC  
1+/rd, R 30 yds)

Devotions:

*Animate Shadow* (Wis -3, IC 7,  
MC 3/rd, R 40 yds)

*Ballistic Attack* (Con -2, IC 5, R 30  
yds)

*Conceal Thoughts* (Wis; IC 5, MC  
3/rd, R 0)

*Contact* (Wis, IC varies, MC 1/rd,  
R special)

*Control Body* (Con -2, IC 8, MC  
8/rd, R 80 yds)

*Control Light* (Int, IC 12, MC 4/rd,  
R 25 yds)

*Control Sound* Gnt -5, IC 5, MC 2/  
rd, R 100 yds)

*Danger Sense* (Wis -3, IC 4, MC  
3/turn, R special)

*Ego Whip* (Wis -3, IC 4, R 40/80/  
120 yds)

*Inertial Barrier* (Con -3, IC 7, MC  
5/rd, R 0)

*Know Location* (Int, IC 10, R 0)

*Molecular Agitation* (Wis, IC 7, MC  
6/rd, R 40 yds)

*Soften* (Int, IC 4, MC 3/rd, R 30 yds)

Defense Modes: Mental Barrier, Mind  
Blank, Thought Shield, Tower of Iron  
Will

PSP: 94

Saving Throws

DM	RSW	PP	BW	Sp
12	13	9	15	14

Weapon Proficiencies: club, dagger,  
spear

Non-Weapon Proficiencies: *Harness  
Subconscious, Heat Protection, Medi-  
tative Focus, Psionic Detection, Read/  
Write Common, Rejuvenation, Sign  
Language*, Survival (sandy wastes)

Languages: Common, halfling, gith,  
halfling, thri-kreen

Equipment: leather armor, bone dagger,  
bone spear, stone club; belt pouch, bot-  
tle of ink, 3 candles, fire kit, papyrus,  
personal seal, quill, sealing wax, silver  
mirror, water bladder; riding kank, sad-  
dle, bridle

Money: 1,620 cp

### Background

First, your beloved master abandoned you, claiming that it was all for the best. Then, you labored and almost died in the slave-pits of Tyr. After the revolt in that city, you aided in its defense against invaders, and carried the struggle back to Urik.

## Thirty: T'Kkyl

Reaction Adjustment: surprise +3

NPCs +3

AT 2 (bite and weapon) or 3/2 (crossbow) or 3 (1 bite and two attacks with chatkcha, dagger, and gythka) or 5 (4 claws and bite)

THAC0: 13

Natural weapons, +/- 4 to punching/wrestling attacks

Chatkcha, +4 to hit (Dex, spec.)

Light crossbow, +3 to hit (Dex) (+5 point-blank, due to specialization)

Obsidian gythka, -2 to hit, +1 specialization

Steel dagger, +1 to hit (spec.), +4 thrown (Dex, spec.)

Damage: Bone-tipped quarrels 1d4-1/1d4-1

Bite 1d4+1 and Save vs. Paralyzation

Claws 1d4

Chatkcha 1d6+4/1d4+3

Obsidian gythka 2d4+1/1d10+1

Steel dagger 1d6+2/1d3+2

AC: 1 (modified for Dexterity)

Hit Points: 62

Wild Talent: All-Round Vision

Power Score: Wis -3

Cost: 6/4 per round

PS: 50

Leap forward 50 feet, leap up 20 feet

Saving Throws

D	M	R	S	W	P	P	B	W	S	P
10		12			11		12			13

Weapon Proficiencies: All (2 slots unused)

Weapon Specializations: chatkcha, dagger, gythka, light crossbow

Non-Weapon Proficiencies: Direction Sense, Navigation, *Sign Language*, Survival (stony barrens), Tracking

Languages: Thri-kreen, common, elven

Equipment: 20 bone-tipped quarrels, crystalline chatkcha, light crossbow, obsidian gythka, steel dagger; fire kit, pack (fitted for thri-kreen), 7 sacks of kank honey, waterskin

Money: 900 cp

### Background

After your pack was almost completely exterminated by human bounty-hunters, you made your way to Tyr, where your human slave-masters set you to work for the mad king Kalak. Now free, you have adopted the adventurers who accompany you as your new pack, and continue the hunt.

While you feel what humans might call "friendship" for your companions, you remember that a few of your original pack survived, although they are now lost to you. The thought that they may still live still smolders in your mind. Perhaps, perhaps...

Your first loyalty is to your new pack, however. Once, you hunted such as these, tracking them across the dunes and consuming them like any other prey. Now, they are your companions, and you would sacrifice yourself for them (and they for you). Maybe someday you will find what happened to your old pack, but for now, you are where you belong and are at least partially content.



## Thirty-One: Mingon of Asticles



"I have an offer of employment for you," says the woman as her attendants pour wine for you. "My family—I am sure that you know Senator Agis of Asticles, my cousin—has heard of you, and is impressed with your bravery and honesty.

"The task that I require is relatively simple, but extremely important. If you accept my offer, I expect you to fulfill your end of the bargain to the best of your abilities."

Of course, this goes without saying, and you are almost offended that Mingon would even suggest such a thing. You continue to listen.

"For a fee of thirty ceramic pieces per day each, plus a bonus of five hundred ceramics upon successful completion of your mission, I want you to help guard an extremely important item. A coffer containing an extremely valuable gift for Lalali-Puy, queen of Gulg, will be part of a caravan that I am sending south tomorrow morning. The caravan guards are competent, but we require extra protection. I want you to guard the coffer, and present it personally to the queen upon arrival in Gulg. We expect no real trouble, but I require an extra measure of security no matter the threat. Are you interested?"

Thirty-Two:  
The Dungeon of Gulg

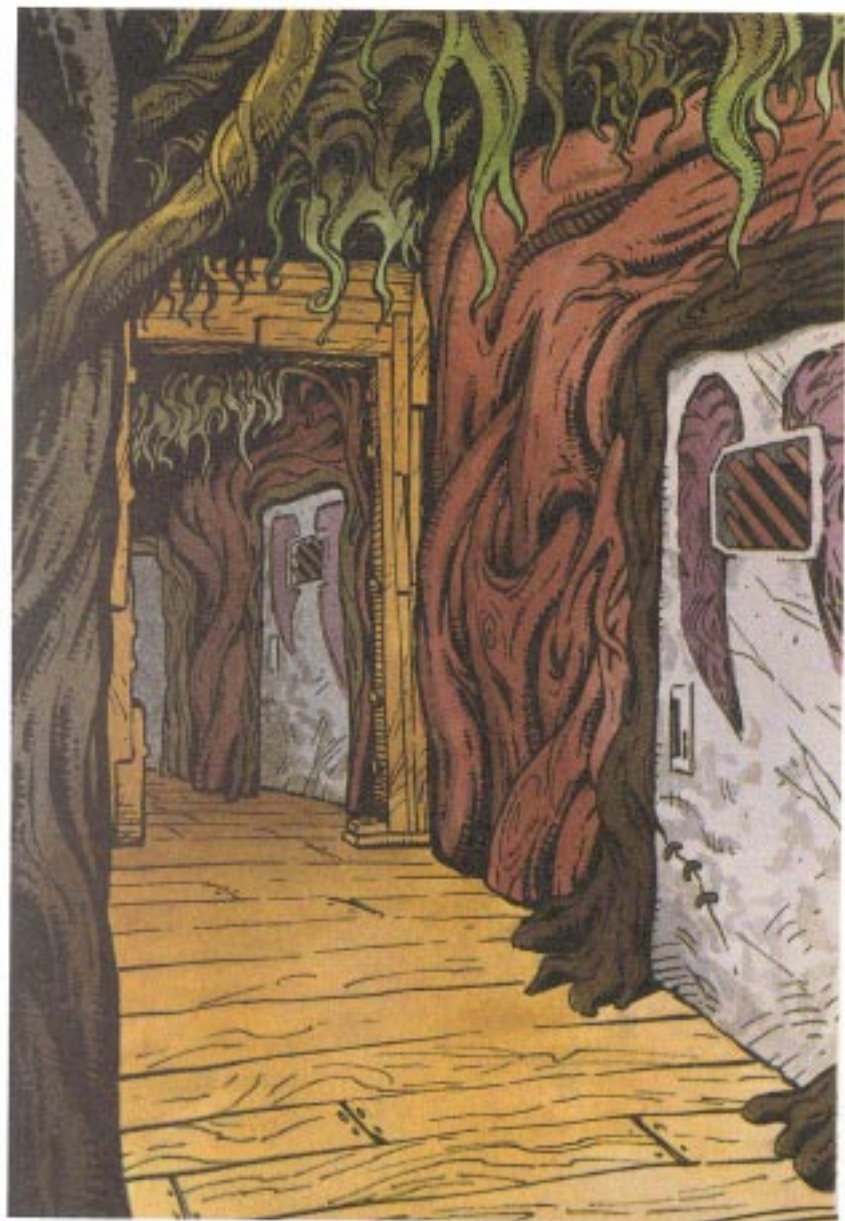

### Thirty-Three: Lalali-Puy, the Forest Queen

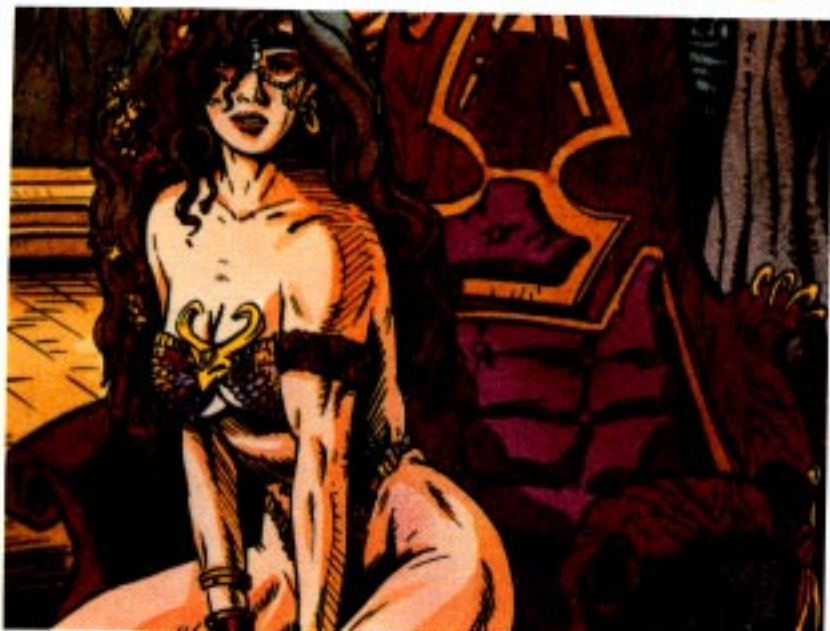

You know little about the so-called "Forest Queen" of Gulg, save rumors that have been repeated and exaggerated in the telling. You have heard that she is literally a goddess, the only deity who did not forsake Athas as it died. You have heard that she is a power-crazed madwoman who sacrifices hundreds of her own citizens in order to keep her precious forest alive. You have heard that she is the only sorcerer-monarch who actually enjoys the popular support of her people. Rumors also speak of her great beauty, capriciousness, and limitless capacity for cruelty.

You do not know which of the rumors to believe, but it seems as if you are about to discover the truth of the matter, as you approach the queen herself.

"Welcome, bold adventurers!" declares the beautiful woman who sits upon the carved wooden throne. As far as her appearance goes, she is everything that the rumors suggest, and more. You wonder with mounting apprehension how many other rumors about her are true as well.

## Thirty-Four: The Shadow King's Palace

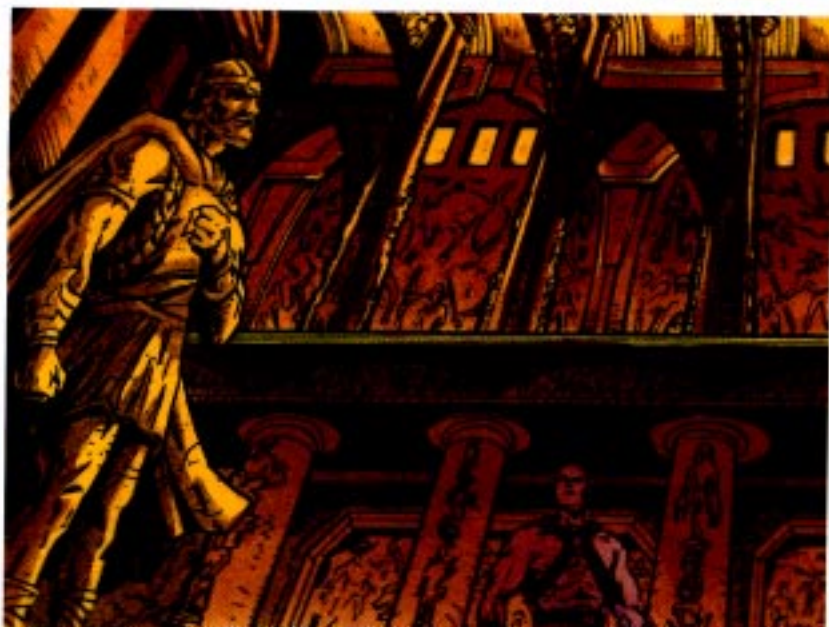

This is but a minor palace of the Shadow King. He himself rarely leaves the vest structure et the center of the city. Like most buildings in Nibenay, the minor palace is covered with carvings of men, monsters, end exotic creatures.

Inside, the hall is vest, lined with columns, terminating in a massive statue, which you recognize as yet another portrayal of the Shadow King.

You are not sure what to expect. Having escaped from Lalali-Puy's warriors and having been reasonably well treated by the Nibeneni templars, it is not clear whether the Shadow King considers you a friend or en enemy. You know that Gulg and Nibenay have been at war over the Crescent Forest for many years, with neither side gaining any advantage.

Of the Shadow King himself, you know next to nothing. You have heard that he named the city after himself—Nibenay—but that he is almost never seen in public. You have occasionally heard stories about his supposed death and the terrible rebellions that they have sparked. You have also heard that Nibenay always appears to crush such rebellions, and there has not been an uprising in over a decade.

Exactly what this mysterious and dangerous monarch wants with you remains to be seen. You seem to have no choice other then sitting and waiting.

# Thirty-Five: Caravan Attack

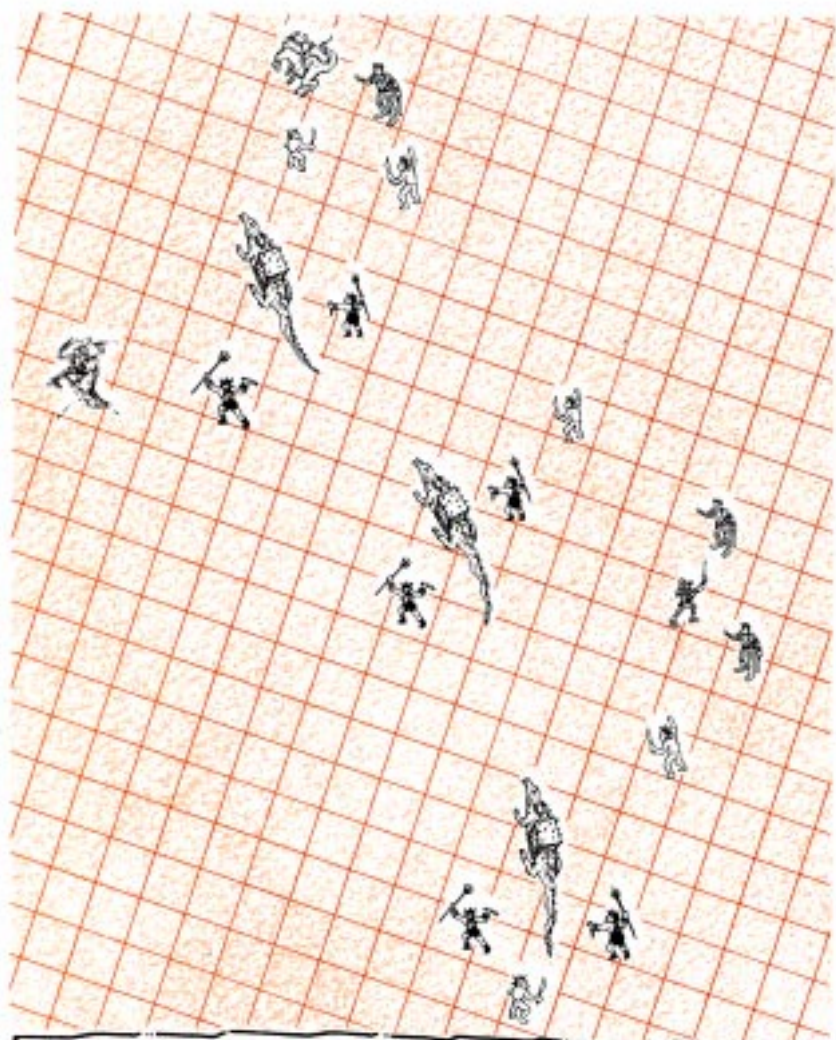

Human guard



Human rider



Inix



Elven rider



Thri-kreen raider



Semponius

1 square = 6 feet

Thirty-Six:  
Habban-Puy



• BOKO 72.

Thirty-Seven:  
Elf Prisoner



Thirty-Eight:  
The Necklace

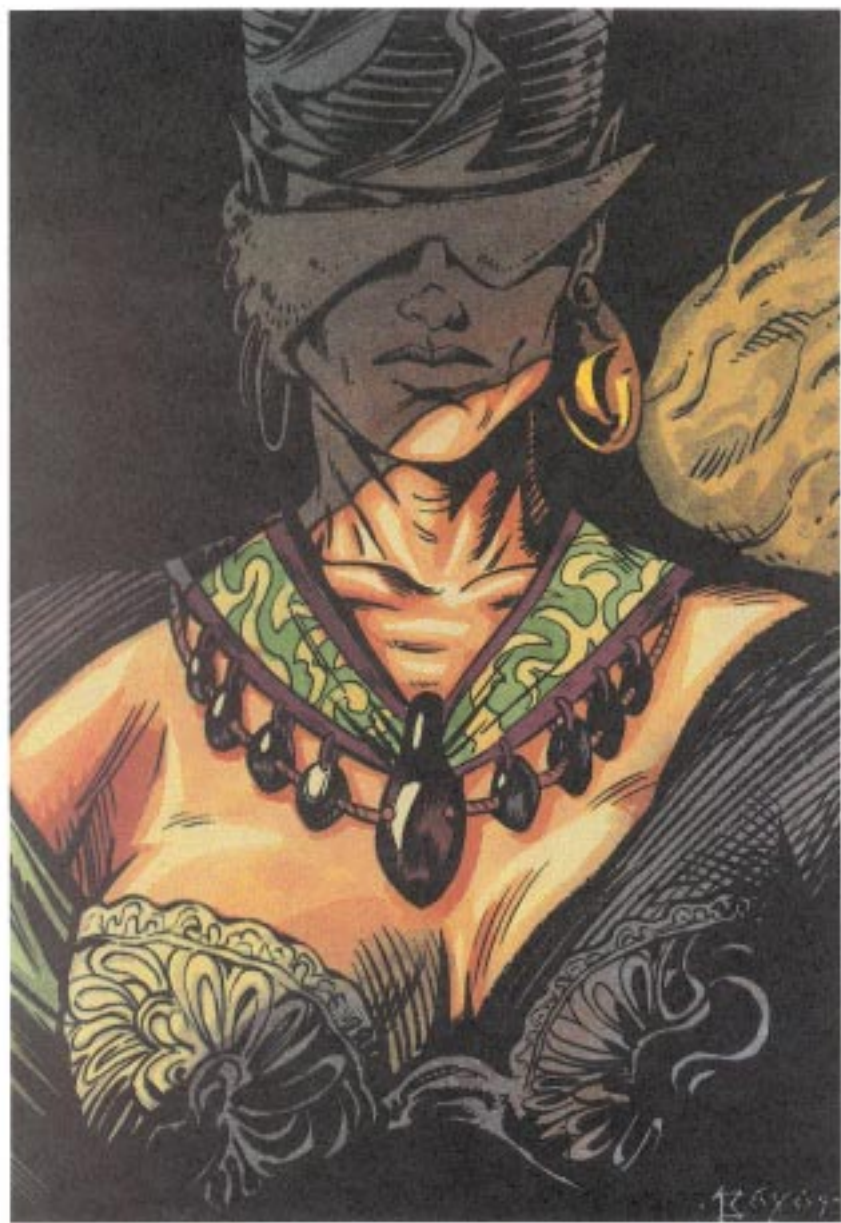



Thirty-Nine:  
The Iron Door



Forty:  
Jozhal Thieves



Forty-One:  
Shala the Hunt Mistress



Forty-Two:  
Taibela



Forty-Three:  
Caravan Battle

·E·K·O·N·



Forty-Four:  
Cistern Fiend



Forty-Five:  
Tovril the Green

Boyer.



Forty-Six:  
Battle in the Vault





Forty-Seven:  
Meeting with Agis



Forty-Eight:  
Athasian Sloth







# DARK SUN

WORLD

Pawns  
of the  
sorcerer-kings

DUNGEON MASTER™ Book

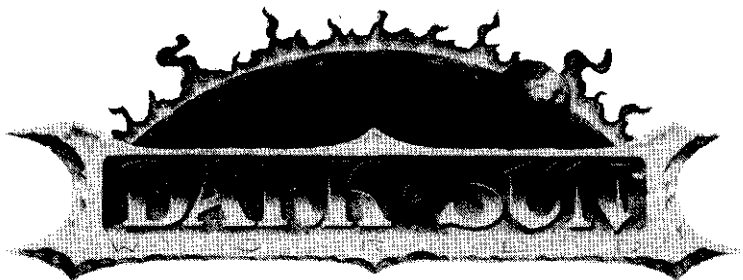

## Astician Gambit

A DARK SUN™ Campaign Adventure

# DUNGEON MASTER™ Book

### Credits

Design: Anthony Pryor  
Editing: Timothy B. Brown with Michele Cartel  
Cover Art: Brom  
Interior Art: Tom Baxa  
Typography: Gaye O'Keefe  
Cartography: Steve Beck  
Graphic Design: Dee Barnett & Sarah Feggestad  
Graphic Production: Laura Samuels

This material is protected under the copyright laws of the United States of America. Any unauthorized use of the material or artwork contained herein is expressly prohibited without the written consent of TSR, Inc. Copyright ©1992 TSR, Inc. All Rights Reserved. Printed in the U.S.A.

Random House and its affiliate companies have worldwide distribution rights in the book trade for English language products of TSR, Inc.

Distributed to the book and hobby trade in the United Kingdom by TSR Ltd. Distributed to the toy and hobby trade by regional distributors.

ADVANCED DUNGEONS & DRAGONS and AD&D are registered trademarks owned by TSR, Inc.

DARK SUN, DUNGEON MASTER and the TSR logo are trademarks owned by TSR, Inc.

All TSR characters, character names, and the distinctive likenesses thereof are trademarks owned by TSR, Inc.

TSR, Inc.  
POB 756  
Lake Geneva  
WI 53147  
U.S.A.



TSR Ltd.  
120 Church End  
Cherry Hinton  
Cambridge CB1 3LB  
United Kingdom

2412XXX0502

I-56076-315-9

Permission granted to photocopy or print this product for personal use.

## Starting the Adventure

*Asticlian Gambit* is an adventure that will involve a party of 4 to 6 high-level characters in a complex plot in the Crescent Forest between Gulg and Nibenay. The player characters should be 7th to 10th level. In the course of the adventure, they will travel from Tyr to the forest-city of Gulg, meet at least one of the mysterious sorcerer-kings, and make several powerful friends and enemies.

**Materials Needed to Play.** In addition to this module, you need the following items to DM *Asticlian Gambit*: the *AD&D® 2nd Edition Player's Handbook* and *Dungeon Master's Guide*, the *DARK SUN™* campaign boxed set, the *Monstrous Compendium*, *DARK SUN Appendix*, *Terrors of the Desert*, and *The Complete Psionics Handbook*.

**Flipbook System.** This flipbook contains all of the information you need to DM *Asticlian Gambit*. The *Player's Book* contains illustrations, maps and other materials to help the players visualize the adventure as it unfolds. Each encounter in this book tells what page the players should be viewing in their book. Relay that page number to the players as the encounter begins.

**Preparation for Play.** The players are free to use the pregenerated characters on pages 20-29 of the *Player's Book*, or to use characters they have generated themselves. The DM also has the option of using *Asticlian Gambit* as the follow-up adventure to *Arcane Shadows*, the previous *DARK SUN™* adventure module (details for using the adventure in this fashion are discussed in the following section).

Have any player who uses a pregenerated character carefully remove the appropriate page from the *Player's Book*. Make sure that each player understands all the information on the character sheet, especially psionic powers and special abilities of class and race. Do not let characters buy any new equipment at this time—they will have the option to do so later depending on where the adventure begins.

**Starting the Adventure.** There are two starting points for *Asticlian Gambit*. Characters who begin the adventure in the city of Tyr start at 1A. Those who begin in the desert (at the end of *Arcane Shadows*, for example) start at 1B.

If they start in Tyr, the players will be offered the opportunity to help defend a caravan bound for the city of Gulg. If they agree to defend the caravan, play will then move on to the Forest-Queen's palace in Gulg, where they will have opportunities to participate in various intrigue and skullduggery. If the characters start in the desert, they will observe the caravan under attack and be given the opportunity to defend it.

## Part One: A—An Offer of Employment

**Setup.** This encounter takes place in a villa located in the city of Tyr. The characters have been summoned by representatives of the Minging faction. The DM may role-play the actual invitation, but may begin the encounter here for the sake of convenience. Have the players turn to *Players' Book* page 31—Minging of Asticles.

**Start.** Read the following aloud:

This morning a slave brought you a message from someone named "Minging of Asticles." The tiny scroll called for a meeting at a wine shop in the Tradesmen's District, "where matters of great profit might be discussed." Although you were suspicious, your curiosity and desire for wealth compelled you to go. Now, you stand before an elderly, powerful-looking woman and her two attendants. She bids you to sit at her table.

**Encounter.** The woman introduces herself as Minging of Asticles, a cousin of the famous Agis of Asticles, who played a prominent role in the recent overthrow of King Kelek (this is not her real name, but the players do not know this).

"I have an offer of employment for you," she says, motioning one of her attendants to pour wine for the characters.

She tells them that a caravan is leaving Tyr for Gulg the next morning. In addition to the caravan's normal cargo of iron, copper, and jade, this caravan is carrying a valuable gift intended for Lalali-Duy, sorcerer-queen of Gulg. Minging wishes to hire the characters to guard the gift. Combined with the caravan's guards, Minging explains, the PCs will provide an added measure of insurance against raiders.

**Role-Playing.** Minging is trying to be friendly, but most characters will be made uncomfortable by her manner. Describe (and, if possible, act out) her overly-familiar manner and the mock sincerity in her voice as she talks with the characters.

**Reactions.** Minging will offer each character 30 cp per day, plus a bonus of 500 cp upon completion of the mission. The trip to Gulg should take 10 to 15 days each way. If the payment doesn't motivate your player characters, Minging will tantalize them further, suggesting under her breath that "a blade of steel seems naked without the influence of magic." Keeping an eye out for prying templars, Minging will promise to use her family's "connections" to gain magical enchantments for any metal weapons the characters possess. Of course, she is an imposter, has no family connections, and doesn't plan to pay the PCs anything more than a 30 cp advance.

Minging is a psionist, and has the telepathic devotion conceal thoughts active throughout the meeting. If PC psionists attempt to use ESP or other powers to read her thoughts, roll a normal power check, but tell the player that the check fails, regardless of score.

**Outcome.** If the characters agree, Minging will pay their front money, tell them that the caravan leaves from the Caravan Gate at dawn, thank them and leave. If the characters are still reluctant, Minging will suggest that Lalali-Puy may have rewards of her own or make other wild claims to get the PCs to join the caravan.

**Next.** Proceed to 1C. If the DM wishes to give the characters a few minor encounters to keep them alert, use one or more encounters from 1B before going to 1C.

## Part One: B—In the Desert

Parties that begin the adventure in the desert start here. This section may also be used to provide encounters for characters who began in Tyr as they travel with the caravan. The DM may use as many of the following short scenes as desired, and in any order.

**House Inika Caravan.** A trio of elven scouts races lightly across the dunes. When they see the PCs they stop well out of effective arrow range and wave, shouting, "Come you for trade, or come you for war?" (a well-known elven greeting). If the PCs reply "trade," then the elves approach, followed soon after by a caravan flying their black banners bearing gold circles, the unmistakable colors of House Inika of Gulg.

If the characters are so short-sighted as to reply "war," the elves will retreat back over the dunes, and the Inika caravan will be re-routed to miss the party.

The caravan is a typical Inika affair—small and fast moving. Most of the trade goods are loaded on crodlu, although this particular caravan has several slower-moving kanks. There are 15 animals in all, including one inix.

The caravan master will greet the party and discuss current events. He is forthcoming about the current situation in Gulg, and in this fashion the PCs will learn that relations between Gulg and Nibenay—antagonistic in even the best of times—have been growing steadily worse. Word now is that open war may break out between the two cities over Nibenay's incessant felling of what the Forest Queen Lalali-Puy feels is "her" timber.

**Anakore Attack.** A group of dune freaks sees the party as easy pickings and attacks from the concealment of the sands, as described in *The Wanderer's Journal*. Tell the players to turn to page 11 for an illustration. If the PCs are accompanying the caravan, the anakore wait until they are near the party before attacking. No other caravan guards help the PCs because other anakore keep them busy. In effect, the PCs are on their own against the dune freaks. Be certain to take full advantage of the anakores' special attacks to make the encounter dangerous for the high-level PCs.

**Anakore (12):** AL NE; AC 8; MV 9/15 Br; HD 3; hp 14; THAC0 17; #AT 2; Dmg 1d4/1d4; SA Surprise, paralyzation, suffocation; SD Burrow; SZ M; ML 12; XP 650

**Belgoi Ambush.** After the party (or caravan) has bedded down for the night, several belgoi attempt to lure characters away from the main group. The attack begins as soon as one or more PCs are on watch, with one belgoi per PC on watch ringing his bell to establish contact, as described in *The Wanderer's Journal*. If the belgoi succeed in drawing one or more party members away, they will attempt to drain Constitution and devour the characters. Should they be successful, the remainder of the party will awaken the next morning and discover no sign of the missing characters, who will be gone forever.

**Belgoi:** AL LE; AC 7; MV 12; HD 5; hp 20; THAC0 15; #AT 2; Dmg 1d4+2; SA Constitution drain; SZ M; ML 9; XP 650; Psionics: Sciences—domination; Devotions—attraction, ego whip, psionic blast, mind blank, contact; Att Modes: EW, PB; Def Modes: M-; Score 12; PSPs 35.



## Part One: B—In the Desert (cont.)

**Waylaid Thri-Kreen.** The party observes a lone mantis warrior being attacked by a war party of gith armed with spears. Tell the players to turn to page 6. If the PCs ignore the battle, the thri-kreen will eventually be slain. If they assist the thri-kreen, they must fight the gith. If the PCs are with the caravan, none of the caravan guards will take any interest in joining the fight, but will not stop PCs from doing so.

**Kru 'ist, thri-kreen warrior:** AL CN; AC 5; MV 18; HD 6+3; hp 35 (down to 25 at time of encounter); THAC0 13; #AT 5; Dmg 1d4/1d4/1d4/1d4/1d4+1; SA Paralyzation; SD Dodge missiles; SZ M; ML 12; XP 1,400

**Gith (12):** AL CE; AC 8; MV 10; HD 3; hp 12; THAC0 17; #AT 1; Dmg 1d6; SA Springing; SZ M; ML 12; XP 175

The rescued thri-kreen will acknowledge its debt to the PCs, even though it does not speak their language (PCs who speak thri-kreen can, of course, communicate freely). It will pull a small gem (worth 7 gp—a considerable sum on Athas) from its pouch and offer it to the PCs. If they accept, the thri-kreen will consider the debt settled.

If they do not accept the gift, the DM may elect to have the mantis warrior join the party as an NPC, to provide additional muscle, at least until it considers the debt settled. If the PCs would rather not have Kru'ist in their party, it will still want to honor its debt and may at some point in the future show up to help the party if they are in need. The exact nature of this assistance is up to the DM.

**Jozhal Thieves.** If the party carries any magical items, they attract the attention of a family of jozhal. True to their nature, the jozhal sneak into camp after dark and attempt to steal the items. At first, a pair of the creatures will try to slip past the sentries, utilizing their camouflage abilities and the *ring of invisibility* (see below). Should this fail, several other jozhal will set up a diversion, dashing back and forth and making noise while their confederates try to grab the desired items. In this case, tell the players to turn to page 40. The thieves will use the dimension door devotion to sneak in close to the items, then to make good their escape. They will also use this power to flee if threatened.

**Jozhal (7):** AL CN; AC 3; MV 18; HD 4; hp 17; THAC0 17; #AT 1; Dmg 1d6; SA Magical items (see below) and spells; SD Camouflage; SZ S; ML 12; XP 1,400; Psionics: Sciences—banishment, contact; Devotions—dimensional door, time shift, time/space anchor, teleport trigger, ego whip, psionic blast, intellect fortress, thought shield, mind bar; Att Modes: EW, PB; Def Modes: IF, TS; Score 14; PSP 80  
Spells: 1st level—*detect magic, cure light wounds, detect poison, locate animals or plants, magical stone*; 2nd level—*silence 15' radius, hold person, flame blade*; 3rd level—*locate object, dispel magic*

Of the seven jozhal, four have magical items. They are a *ring of invisibility, fruit of extra healing, rope of climbing*, and a *luckstone*. Four of the jozhal have one of these items each and will use it however the DM sees fit.

## Part One: C—The Way to Gulg

**Setup.** This encounter begins the day after the party accepts Mingon's offer. It serves to introduce the PCs to life with the caravan, and gives them an opportunity to inspect the mysterious item they are taking to Lalali-Puy.

**Start.** Read the following out loud:

The caravan leaves through the gates of Tyr at daybreak. It is but one of many caravans bound for all parts of the region. The caravan master, an officious dune-trader who treats you with slightly more concern than his *crodlu*, tells you of your mission.

"Here," he scoffs, tossing you a small bronze coffer. "You're responsible for this. Why that old kank Mingon couldn't trust it to us is beyond me. Anyway, it's your heads if anything happens to it. Don't open it if you value your lives."

With that, the caravan sets off into the desert, falling into a daily routine of marching, patrolling, and camping at sundown. All goes well for the first several days.

**Encounter.** There is no encounter in this section, unless the characters wish to investigate the contents of the mysterious coffer.

Since the coffer contains an item of great importance, it is appropriately protected. First of all, it is triple locked, and there is a -3 penalty to any open locks rolls for all three because of their masterful construction. The keys have been sent separately to Lalali-Puy for security purposes. Once the locks have been opened, there is a magical shock trap on the coffer, which will inflict 6d10 dice of electrical damage on anyone other than Lalali-Puy who attempts to open the coffer and 3d10 points to anyone within ten feet (save versus paralyzation for half damage).

If, after all this, the PCs still want to open the coffer, they will be disappointed to find an exceedingly ordinary necklace inside. If the PCs do this, tell them to turn to page 38—The Necklace, for an illustration.

**Outcome.** After nursing their wounds, the PCs will have to decide what to do with the necklace. *Detect magic* and other abilities will reveal that the necklace has no special enchantments. Replacing the necklace will reset the trap, and when Lalali-Puy opens the coffer she will be too eager to see the necklace to notice any signs of tampering.

Particularly abstinent parties may try to escape across the desert with the necklace. If this happens, they will be attacked by Mogadisho and his relief force from part 1F, in which case they will be thrown into Gulg's dungeon without the benefit of going through Part Two.

**Next.** Proceed to 1E for the fateful encounter with desert raiders. If the PCs were so foolish as to try to steal the necklace, proceed to 1F. Have Mogedisho attack them with sufficient forces the entire party, and proceed to the dungeons of Gulg in Part Three.

## Part One: D—Caravan Attack

**Setup.** This scene occurs if the party begins in the desert. It presents the PCs with the Mington caravan under attack by Semponius and his raiders, and presents the party with the option of helping to defend the caravan.

**Start.** The encounter takes place mid-day as the party is trudging through the dunes. Have the players turn to page 43—Caravan Battle, but make it clear that they are still a good distance away from the fight. Read the following out loud:

Ahead you hear the sounds of battle. Hastening forward, you see a caravan—inix, crodlu, wagons and guards—under attack by a mixed bag of desert raiders. A group of elves flings spears at the defenders, while a lone mantis warrior leaps into the fray, swinging its weapons with deadly accuracy. A robed figure mounted on a crodlu seems to be directing the attack.

**Encounter.** The purpose of this encounter is to allow the PCs to observe the attack from a distance away, and give them time to decide what to do. They can join the battle on the side of the caravan, join the battle on the side of the raiders and their robed leader, or they can attempt to avoid the battle altogether.

Player characters who join the battle on the side of the caravan will join a grateful contingent of beleaguered guards. In all the confusion, it is easy for the PCs to approach the raiders from behind, selecting particular warriors to engage in combat.

If instead the PCs wish to partake in the sack of the caravan, they will quickly become disillusioned. As they approach, a cry will rise up among the raiders. “Mercenaries from Gulg! The caravan’s reinforcements are behind us!” Despite their best efforts, the PCs will be mistaken for allies of the caravan, so will have to fight against the raiders anyway.

If the DM feels that the party is being overly-cautious, or if they decide to remove their characters from the situation without helping either side, force the matter by having the battle spill over toward their position. Again, the raiders will mistake the PCs for caravan reinforcements or stray guards and attack them.

**Outcome.** Essentially, no matter what the PCs try to do, they are drawn into the caravan battle on the side of the caravan. If they had animals of their own, the raiders drive them off during the battle.

**Next.** Proceed to 1E.

## Part One: E—Battle at the Caravan

**Setup.** This is the penultimate encounter of this section. The player characters are fighting alongside the guards of the caravan, and will plan their actions accordingly. Tell the players to turn to page 43—Battle at the Caravan. Then have them position their characters among the circle of defenders on the map on page 35. The same map is provided for the DM's reference on the next page of this book.

**Start.** If the PCs began with the caravan, read the following paragraph:

The days pass slowly and uneventfully. As you approach Gulg, it begins to look as if you will actually earn your money with minimal effort.

Then, early one morning, you hear strident shrieks echoing across the desert, and see, bounding over the dunes, a horde of ragged desert raiders.

**Encounter.** The fight at the caravan is fast, furious, and bloody. Use the map and the PCs' positions to determine opponents for the skirmish. The raiders and guards must check morale if the battle goes against their side.

**Role-playing.** Quarter is neither asked nor given. Role-playing in such a merciless melee is minimal at best.

**Statistics.** The various raiders and caravan defenders are given here. The PCs will fight their nearest enemies, then go on to the next.

*Human Raiders and Human Guards:* AL N; AC 10; MV 12; HD 4d10; hp 26; THAC0 17; #AT 1; Dmg 1d6; SZ M; ML 12; XP 15

*Elven Raiders:* AL CN; AC 10; MV 12; HD 5d10; hp 34; THAC0 16; #AT 1; Dmg 1d6; SD Surprise foes; SZ M; ML 13; XP 35

*Thri-kreen Raider:* AL N; AC 5; MV 18; HD 6+3; hp 25; THAC0 13; #AT 5; Dmg 1d4/1d4/1d4/1d4/1d4+1; SA Paralyzation; SD Dodge missiles; SZ L; ML 17; XP 1,400

*Semponius of Asticles, leader.* AL NG; AC 9 (-4 due to dexterity); MV 12; F6; hp 30; THAC0 15 (+1 due to strength); #AT 1; Dmg 1d8 (bone sword, +1 due to strength); Str 17; Dex 18; Con 11; Int 12; Wis 9; Cha 18.

**Outcome.** If the PCs are doing well, have the attackers flee, leaving only corpses behind. The PCs will be the heroes of the caravan, their wounds will be bound (although no magical healing is available). The caravan will meet Mogedisho's relief force in 1F, and then proceed in triumph to Gulg.

If the PCs get badly beaten up and seem in danger of losing, proceed to 1F and the arrival of Mogedisho to save the day.

Note in all cases whether Semponius was killed. If he was slain in the battle end the DM still wishes to use him, he can be encountered later. If this happens, explain that Semponius was badly wounded but somehow survived the ordeal.

**Next.** Proceed to 1F.

Part One:  
E—Battle at the Caravan (cont.)

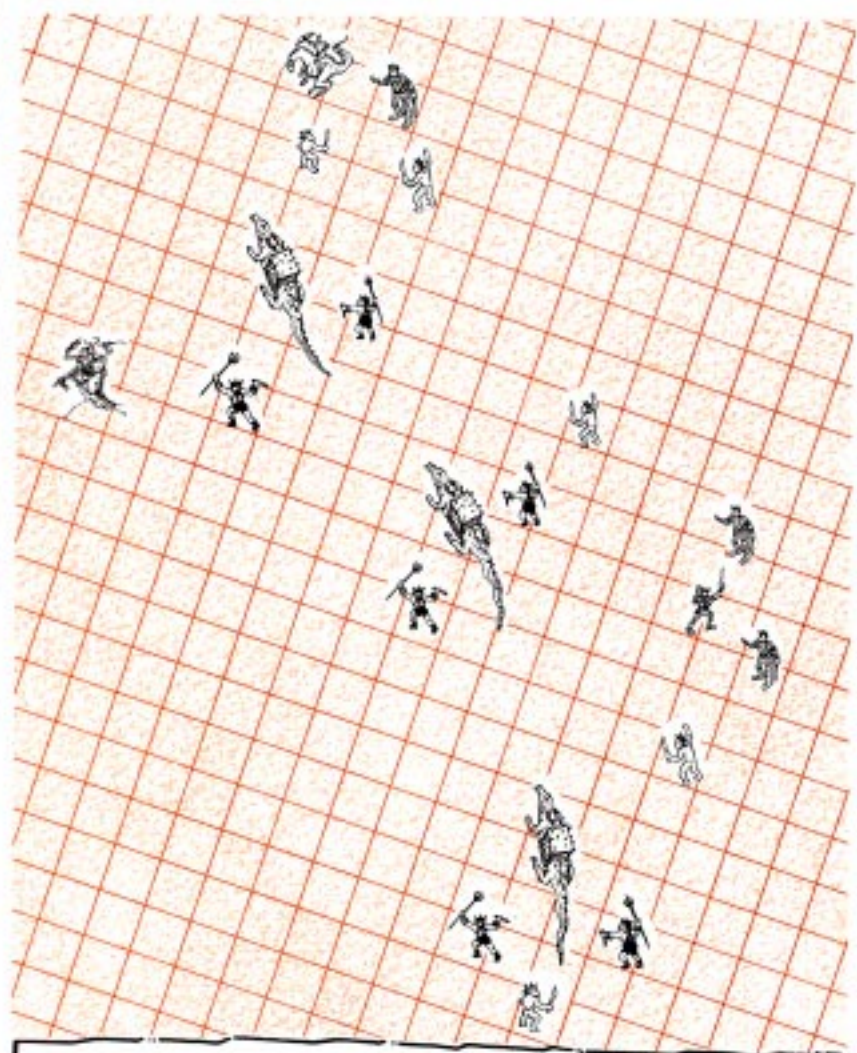

Human guard



Human raider



Inix



Elven raider



Thri-kreen raider

Semponius



1 square = 6 feet

## Part One: F—Mogadisho!

**Setup.** If the PCs are being defeated, this encounter occurs just before the PCs are defeated. If the battle at the caravan goes well for the PCs, then Mogadisho and his warriors arrive just after the raiders have fled. Al so, this encounter can occur if the PCs are attempting to carry off the necklace, in which case Mogadisho's troops attack, to capture the party. Tell the players to turn to page 14—Mogadisho.

**Start.** If the PCs are being defeated in the battle at the caravan, read the following: Most of the caravan guards have died or fled, and the screaming raiders are closing in on you. Suddenly, a hail of arrows cuts down several raiders, and over a dune you see crodlu-mounted warriors. When they see the crodlu riders, the raiders suddenly lose heart and flee. Most are cut down, but the robed leader is captured.

If the PCs won the battle, read the following:

As you rest in the aftermath of the battle, a group of crodlu riders appears, followed by dozens of human warriors. "Hail, the caravan!" shouts a voice. "We have come from Gulg to escort you to the most sacred and beloved Forest Queen!"

**Encounter.** Realizing the importance of the shipment from Mingon, Lalali-Puy sent a column of troops under her war leader Mogadisho to meet the caravan.

**Role-playing.** Mogadisho is an arrogant, brutal templar, used to serving his queen in the most direct and violent way possible. He will be highly critical of the party's handling of the battle, regardless of outcome.

**Dialogue.** "Who deployed your forces? A anakore could have done better!"

**Statistics.** The number of warriors and crodlu at Mogadisho's disposal is up to the DM—essentially, he has enough warriors to accomplish his goals in this encounter.

**Warriors:** AL N; AC 8; MV 12; HD 2; hp 8; THAC0 13; #AT 1; Dmg 1d6+1 maces); SZ M; ML 11; XP 35

**Mogadisho, Warlord of Gulg.** AL NE; AC 8 (-3 due to dexterity); MV 12; Te 5; hp 50; THAC0 12 (+3 due to strength); #AT 1; Dmg 2d4 (*bronze broad sword* +1, +7 due to strength); Str 19; Dex 17; Con 14; Int 11; Wis 10; Cha 17. Wild Talent: Know Location; PS 11; Cost 10; PSPs 40. Spells—1st level: *animal friendship, create water, cause light wounds, curse, light*; 2nd level: *aid, barkskin, flame blade, speak with animals, spiritual hammer, silence 15' radius*; 3rd level: *animate dead, create food & water, dispel magic, locate object, summon insects*; 4th level: *animal summoning 1, cloak of bravery, produce fire, rejuvenate, sticks to snakes*; 5th level: *animal summoning 11, cause critical wounds, flame strike*; 6th level *blade barrier, wall of thorns*; 7th level: *firestorm*.

**Outcome.** Mogadisho will remain surly but escorts the party back to Gulg. If the party was trying to steal the necklace, Mogadisho's troops will make short work of them. Any who are not killed outright are transported to the dungeons of Gulg.

**Next.** Proceed to 2A.

## Part Two: A—Entrance to Gulg

Having successfully defended Mingon's gift to the sorcerer-queen Lalali-Puy, the party now arrives in the city state of Gulg, where they are greeted as heroes. Needless to say, their heroic status does not last long, and they soon fall afoul of the treachery and double-dealing of Gulg's court.

This first encounter of Part Two, 2A, details the PCs encounter with Lalai-Puy herself, the presentation of Mingon's gift, and the queen's generous (but dangerous) offer of hospitality.

The main purpose of Part Two is to expose the PCs to palace life, and (less benevolently) to land them in the dungeon. Part 2B should accomplish this easily. Although Part Two allows numerous opportunities for role-playing, the PCs will end up in the dungeon regardless of their actions.

**Setup.** Tell the players to turn to page 9—Gulg, where they can find a picture and read a general overview of the city-state of Gulg.

**Start.** The encounter begins with the characters' entrance into Gulg. Read the following out loud.

You are awestruck by the lushness of Gulg and its surroundings. Nowhere save the Forest Ridge are there so many green and growing things. Gulg is surrounded by a thick hedge of thorns, and the city itself consists of circular mud and thatch huts. As a party of templars meets with the caravan master, two other templars conduct you toward the center of the city, where grows a gigantic agafari tree. Perched in its highest branches is a wondrous sight—Lalali Puy's palace. You enter through the trunk of the mighty tree, and are led up winding stairs.

At length, you enter a gleaming white, high-ceilinged chamber. Various slaves, courtiers and soldiers stand around the room, and at one end you see several large, gnarled trees. Wizards recognize these as *Trees of Life*— this is how Lalali-Puy casts her defiler magic without damaging her precious forest, or her leafy home.

"Abase yourselves in the presence of the Forest Queen!" bellows a voice. At the other end of the room, seated on a throne carved from the wood of the agafari tree, is the Forest Queen herself.

Tell the players to turn to 33—Lalali-Puy, where they can see a picture and read some general information about the Forest Queen.

**Encounter.** The PCs are now in the presence of one of the most powerful beings on Athas, the Forest Queen Lalali-Puy. This encounter will introduce the PCs to their hostess and allow them to turn over the item they are carrying for her.

Lalali-Puy, while evil to the core, does not stand on ceremony as much as some other sorcerer-monarchs. If the PCs conduct themselves with suitable humility, she will put down any social gaffes to their barbaric origins. Characters are not relieved of their weapons because they all should now that it is absolute suicide to use them. If the PCs do not immediately comply by laying face down on the floor, a pair of mul guards will force each PC to do so. If the PCs cooperate, willingly or not, Lalali-Puy will request the coffer that the PCs have been guarding (see below for dialogue).

## Part Two: A—Entrance to Gulg (cont.)

A mul will come forward to accept the coffer, then proffer it to the oba, eyes averted. If the PCs do not turn over the coffer, Lalali-Puy will become angry and order the party to be taken to the dungeon.

If the PCs turn the item over, read the following out loud:

The Forest Queen accepts the coffer and opens it greedily. When she sees what is inside, her eyes light up. She reaches in and withdraws a necklace made of silver wire and gleaming grey-black stones. It does not look like an item of any great value, but the Forest Queen is certainly impressed.

“Ah!” she breathes. “It is everything we had hoped for. Please, brave adventurers, accept our hospitality for a few days as an expression of our gratitude.”

Instruct the players to turn to 38—The Necklace for an illustration of the item.

**Role-playing.** Lalali-Puy uses the royal “we” when referring to herself. She is everything one might expect in a sorcerer-queen-distant and imperious.

She extends her invitation primarily because the outlanders amuse her, and she does retain some slight gratitude for their actions. She expects them to end up in the dungeons eventually, but wants them to enjoy themselves in the meantime.

### *Dialogue.*

“Welcome, bold adventurers! Our templars have told us of your bravery, and how you defended our property with your lives! You may present it to us now.”

“Enjoy your stay in our palace. Everything you see is for your use and pleasure.”

**Reactions.** While minor social misconduct (forgetting the proper form of address, etc.) will be tolerated, direct insults or blatant defiance will not be. Should the party refuse a direct order from the Forest Queen, start a fight, or engage in any similar behavior, she will not hesitate to have them taken away to the dungeons.

To this end, she will utilize as many mul guards and templars as she needs. Should these prove inadequate, she will use psionics and defiler magic to subdue the party. She will have no qualms about killing party members, but will want to keep several alive for the Red Moon Hunt. As Lalali-Puy’s psionic and magical abilities are, in the context of this encounter, unlimited, the DM may use any spells or powers.

All muls and templars encountered in Gulg for the remainder of the adventure use the following statistics.

**Statistics. Mul Guards:** AL N; AC 10; MV 12; F 4; HD 4; hp 32; THAC0 17; #AT 1; Dmg 1d6 (spears); SZ M; ML 16; XP 270

**Templars.** AL NE; AC 8 (leather armor); MV 12; Ta 4; hp 15; THAC0 18 (-2 penalty for obsidian weapons); #AT 1; Dmg 1d6-1 (obsidian short sword); ML 15; Str 10; Dex 12; Con 13; Int 12; Wis 10; Cha 12. Spells—2 1st level, 1 2nd level

**Outcome.** If the PCs insulted Lalali-Puy, the survivors are carried off to the dungeons. If the PCs accept the Forest Queen’s offer of hospitality, they are conducted to luxurious quarters, and allowed free run of the palace.

**Next.** If the PCs are taken to the dungeons, proceed to Part Three. If the PCs were sensible and agreed to whatever Lalali-Puy said, go to 2B.



## Part Two: B—Trouble in Paradise

**Life in the Palace.** The purpose of the following scenes is, essentially, to land the PCs in Lalali-Puy's dungeons, if they are not there already. Although the outcome each scene is the same, the DM should allow the players to follow whatever course action they desire. Above all, do not let them think that their eventual fate—internment in the Forest Queen's prisons—was inevitable.

Have the players turn to page 17—The Palace for a picture and information about Lalali-Puy's home. The PCs are free to roam the palace to their hearts' content. Describe a lush, tropical paradise amid the broad branches of the oba's agafari tree—large, luxurious huts, vast meeting chambers, pleasant sitting chambers, and a magnificent view of Gulg and the Crescent Forest beyond. Colorful birds fill the air with song, and iridescent lizards and insects decorate the mighty tree's trunk and branches.

The party is housed in great luxury, and are offered numerous delicacies and as much water and wine as they can drink. Other features of the Sunlight Home are too numerous to describe fully, and the DM is encouraged to invent additional areas of interest, such as a vast library, art gallery, solarium, or menagerie.

Several of the huts that perch amid the leafy growths of the tree are forbidden, heavily guarded by Lalali-Puy's mul slaves. They contain various important individuals, or the Forest Queen's private shrines or quarters. Forced entry into any of these areas will result in immediate apprehension and imprisonment.

Otherwise, allow the PCs to roam the tree for as long as they wish. After the party has sufficiently sampled life in the sorcerer-queen's palace, proceed to one or more of the following scenes.

### Scenes in the Palace

**Setup.** The following scenes serve to both introduce the party to the various individuals who inhabit the queen's palace, and to get the party into sufficient trouble to land them in prison. Allow the characters to indulge in the everyday decadence of the palace, and introduce one or more of the following scenes when action begins to slacken. While not all of the of the following scenes will necessarily end with the party in the dungeon, be certain to keep introducing scenes until they do.

**Spunt the Jester.** Tell the players to turn to page 3—Spunt the Jester. A brightly-clad halfling begins to follow the party around, occasionally running up to pinch or otherwise annoy a PC. When the party eventually turns its attention to the halfling, he dances briefly along a branch and cries out in a singsong voice, "Outlanders! Outlanders! The Forest Queen has brought new animals to add to her menagerie! What sort of animals are you?" If this fails to elicit a response he will pelt the party with rocks and twigs.

The jester will continue in this vein until he gets bored or until the party responds physically, in which case he will unleash his considerable psionic abilities against them, laugh merrily at their discomfiture, and vanish, to reappear at another time to further annoy the party. He will simply see all this as good, clean fun, and will not complain to Lalali-Puy or call for help unless he seems to be losing a fight.

## Part Two: B—Trouble in Paradise (cont.)

If the party proves more powerful than Spunt, he will cry for help, bringing mul guards and templars to his defense. This will result in the party's arrest and internment.

*Spunt the Jester.* AL CE; AC 10; MV 6; Ps8; hp 38; THAC0 17; #AT 1; Dmg 1-3 (jester's rod); Str 9; Dex 11; Con 11; Int 15; Wis 19; Cha 18. Psionics: Sciences—domination (15), mindlink (14), telekinesis (16), teleport (15); Devotions—animate object (12), contact (13), create sound (8), ego whip (16), ESP (15) id insinuation (15) invisibility (10), levitation (16), mind thrust (17), repugnance (14) teleport trigger (16), time shift (15), truthhear (19); Att Modes: EW, II, MT; Def Modes: M-, TS, MB, IF; PSPs 140.

**Habban-Puy the Fetish Keeper.** Lalali-Puy's chief defiler and official guardian of her personal idols and fetishes, has noticed the party's presence. Always concerned about his possession, he is jealous of anyone who catches the Forest Queen's eye, and conspires to catch the party in a trap.

After several days, Habban will have figured out which of the PCs are spellcasters. With this in mind, he will approach the magic-using characters and attempt to talk shop. Have the players turn to page 36—Habban-Puy. What sort of magic do they do? What components do they use? How do they record spells?

Should the PCs be reluctant to discuss this (remember, spellcasting is a crime in the cities of Athas), Habban will assure them that his lips are sealed—spellcasters have to stick together, after all. He will seem quite sincere in this.

If the characters stick to their guns and refuse to discuss the matter, Habban will eventually give up, but will harbor a grudge against the party, and will tell the palace slaves to keep an eye out for illicit spellcasting.

If the PCs warm to Habban, he will eventually suggest a little friendly workshop. He will cast a few spells, then ask the PCs to cast a few, so he can study their techniques. If the PCs do this, Habban will immediately summon the guards and have the party arrested. Hidden slaves will swear that the PCs used illegal magic.

*Habban-Puy, fetish keeper of Gulg.* AL NE; AC 10; MV 12; D15; hp 24; THAC0 16; #AT 1; Dmg 1d4+Poison Type L (bone dagger); Str 8; Dex 12; Con 15; Int 20; Wis 11; Cha 13. Spells—1st Level: *affect normal fires, armor, burning hands, magic missile, wall of fog*; 2nd Level: *darkness 15' radius, flaming sphere, invisibility, knock, summon swarm*; 3rd Level: *dispel magic, fireball, fly, haste, lightning bolt*; 4th Level: *dimension door, ice storm, minor globe of invulnerability, polymorph others, wall of fire*; 5th Level: *chaos monsters, cloudkill, monster summoning 111, passwall, wall of stone*; 6th Level: *chain lightning, stone to flesh*; 7th Level: *finger of death*

**Taibela, Chief of Thieves.** All types of characters find a place in Lalali-Puy's court, including thieves. Should the Forest Queen require a certain item, she sends her thieves to steal it. Supreme among all thieves is Taibela, and the appearance of "exotic" foreigners gives her the chance to hone her skills.

## Part Two: B—Trouble in Paradise (cont.)

Taibela takes great pride in her ability to work alone, and will wait until the party's guard is down (at a meal, at night, etc.) before attempting to steal one or more of the PCs' valued items. If caught, she will fight and attempt to escape. If she fails, she will raise the alarm, bringing muls and templars running, and accuse the party of assaulting her.

If she succeeds in stealing one or more items, there are several possible outcomes. she finds evidence that any of the party are wizards (spell-strings, material components, wizardly magical items, etc.) she will immediately have the party condemned as rogue spellcasters, resulting in their imprisonment.

If Taibela steals nothing magical, she will prominently display the items she stole at an official function, daring the PCs to accuse her of theft. Of course, if they do so, she will respond as above, summoning the guards and accusing the party of assault. If the PCs actually see her, have the players turn to page 42—Taibela.

**Taibela, Chief of Thieves.** AL CE; T14; AC 8 (+1 leather armor, -4 due to dexterity); MV 12; HD 14; hp 54; THAC0 14 (+1 due to strength); #AT 1; Dmg 2d4 (steel broad sword, +1 due to strength); Str 17; Dex 17; Con 15; Int 14; Wis 7; Cha 12. Wild Talent: Flesh Armor; PS 12; Cost 8/4; PSP 60

**Mogadisho the Warlord.** Tell the players to turn to page 14—Mogadisho, but note that the warlord is currently not mounted on a crodlu. The queen's greatest general is a firm believer in the warrior ethic. In his view, only warriors are worthy of glory and success, and (although he is actually of the templar class) he considers himself the greatest and most powerful warrior of them all.

To this end, he is somewhat incensed at all the attention the party 'is getting. He will approach the party, asking them about their past adventures, and denigrating their fighting skill with knowing comments ("I've fought gaj before—they're no great challenge to a warrior who knows what he's doing;" "Only a fool would fight elves in that fashion!" and so on.)

After sufficiently annoying the party, he will challenge its best fighter to a contest of arms—he will even handicap himself by agreeing not to use his spells. If the party refuses, he will condemn them as cowards and stalk off, to later heap abuse on them when they are hauled before Lalali-Puy in 2C.

If the PC agrees to fight Mogadisho, he insists they face off against each other with clubs. Several court members watch the battle that can occur anywhere in the palace.

Mogadisho is a skilled warrior, but he is out of practice, used to directing battle from the back of an inix. After initial success, he begins to tire. Beginning on the fifth round of combat, if the PC is still on his feet, subtract one from Mogadisho's attack rolls. On each subsequent round, subtract one more. If the PC shows a little determination, Mogadisho will probably be defeated. When he reaches five hit points or less, he will grow red in the face and shout for the guards. He will then accuse the PC of assaulting him, and have the entire party arrested.

## Part Two: B—Trouble in Paradise (cont.)

**Mogadisho, Warlord of Gulg.** AL NE; AC 8 (-3 due to dexterity); MV 12; Te 15; 50; THAC0 12 (+3 due to strength); #AT 1; Dmg 2d4+1 (*bronze broad sword +1*, +7 due to strength); Str 19; Dex 17; Con 14; Int 11; Wis 10; Cha 17. Wild Talent: Know Location; PS 11; Cost 10; PSP 40. Spells—1st level: *animal friendship, create water, cause light wounds, curse, light*; 2nd level: *aid, barkskin, flame blade, speak with animals, spiritual hammer, silence 15' radius*; 3rd level: *animate dead, create food & water, dispel magic, locate object, summon insects*; 4th level: *animal summoning I, cloak of bravery, produce fire, rejuvenate, sticks to snakes*; 5th level: *animal summoning II, cause critical wounds, flame strike*; 6th level: *blade barrier, wall of thorns*; 7th level: *firestorm*.

**Shala, Hunt Mistress.** Shala, a gifted but thoroughly evil woman sees the party as excellent challenge for the upcoming Red Moon Hunt, and arranges for them to be imprisoned. There is an illustration of Shala on page 41 of the **Player's Book**, but the characters will probably not actually see her until the hunt begins.

Her scheme is simple enough, and will only be put into action if none of the other plans for the party's downfall are effective. She will merely have some of her friends and allies in the court begin spreading rumors to the effect that the characters are as from the slave-king of Tyr, sent here to gather intelligence and possibly start a r-style revolt in Gulg. Eventually, these rumors will reach Lalali-Puy's ears. Whether she believes the rumors or not is irrelevant—their mere existence is, at least in the Forest Queen's eyes, evidence that the characters are dangerous. She will dispatch guards to arrest the characters, and they will be condemned before they are fully aware even of what they are charged with.

**Shala, Hunt Mistress of Gulg.** AL NE; AC 10 (-4 due to dexterity); MV 12; F15/Ps10; hp 66; THAC0 6 (+1 due to strength); #AT 2; Dmg 1d8 (steel scimitar; +1 due to strength)/1d8 (longbow); Str 17; Dex 20; Con 18; Int 17; Wis 15; Cha 13. Psionics: Sciences (5)—disintegrate (11), mindlink (10), psychic crush (11), superior invisibility (14), telekinesis (12) Devotions (15)—animate object (16), attraction (11), awe (11), ballistic attack (16), ego whip (12), esp (11), inflict pain (14), invincible foes (12), invisibility (14), levitation (12), life detection (17), mind thrust (13), molecular agitation (15), psionic blast (10), soften (17) Att Modes: PsC, EW, MT, PB; Def Modes: M-, TS, MB, IF, TW; PSPs 227.

**Outcome.** One or more of these encounters will end in an NPC calling for the party's arrest. When this happens, as many mul guards and templars as are necessary to subdue the party will arrive and attempt capture. An encounter may be fought out, but the PCs must eventually be defeated. If necessary, have Habban-Puy appear to add magical muscle to the attack.

**Next.** Proceed to 2C to mete out the queen's justice.

## Part Two: C—The Queen is Displeased

**Setup.** This encounter takes place in the queen's audience chamber after one or more of the characters have run afoul of palace intrigues. The PCs are stripped of their weapons and equipment and escorted by an overwhelming number of muls and templars to an audience with the queen. Have the players turn to page P-The Queen is Displeased for a picture.

**Start.** Read the following out loud:

"So," she says, "you have chosen to reject the hospitality that we so generously offered. You have behaved with all the politeness and reserve of halfling crodluherders! Explain yourselves!"

**Encounter.** The court members who the PCs encountered in the previous scenes—Spunt, Mogadisho, Tabeila, etc.—are present in the audience chamber, and will egg the queen on with their own accusations.

Each time the PCs attempt to explain themselves, their accusers interrupt, shouting new charges, making a terrible racket. Eventually, the queen will grow weary of the entire matter and condemn the PCs to the dungeons.

Then, Shala the Hunt Mistress will slyly interject her own scheme. "Perhaps her majesty would like to give the prisoners a fighting chance. The Red Moon Hunt is in two nights, and I am sure they will make fine sport." At this Lalali-Puy will smile, nod, and order the PCs taken away.

**Role-playing.** The queen is as imperious as ever, but her anger is only barely restrained. The court members who accuse the PCs are plainly having a good time—tormenting outsiders is rare fun for them. They are rude, abrasive, and sarcastic, and barely let the PCs get a word in edgewise. No one will elaborate on just what the "Red Moon Hunt" might be.

### *Dialogue*

"These ruffians have no respect for your majesty! Show them how we treat impolite foreigners!"

"Show them the inside of the dungeons, majesty! They will learn proper respect there!"

"Listen to them babble with their strange accents! Foolish foreigners — speak like civilized beings or do not speak at all!"

**Reactions.** If the PCs attempt to fight, Lalali-Puy, her court members, templars and muls will render them helpless in the most direct way possible. They will be most interested in keeping the PCs alive, but will have no qualms about slaying one or two.

**Outcome.** The PCs are hustled down into the dungeons, guarded heavily enough so that they cannot escape, and given no opportunity to effectively plead their cases.

**Next.** Proceed to Part Three.

## Part Three: A—Down to the Dungeon

**Setup.** The PCs, having had all their weapons and equipment confiscated, are escorted under heavy guard down into Lalali-Puy's dungeons. Tell the players to turn to page 32—The Dungeon.

**Start.** Read the following out loud:

The Forest-Queen's guards escort you deep into the interior of the great tree, down narrow stairs carved from the living wood. Its corridors are numerous, and your ability to observe or mentally map them is limited. Finally, you reach the dungeon-twisted corridors and gnarled passageways that follow the giant tree's roots. In places mud and entangling roots hang from the ceiling, and the dampness is most unusual. Against one wall you approach a heavy, guarded door. The door itself is made of thick wood and reinforced with a fortune in iron bars. The mul guards sport steel armor, and keep a grim eye on you as you are led past.

"Eyes down, prisoner!" barks one of your guards, cracking a whip. "That's not for you to see!"

**Encounter.** The purpose of this encounter is to get the party members into their cell in the dungeon and to allow them to see the heavily guarded door. This is where Lalali-Puy's necklace is held, which will become more important in Part Four of this adventure. Point out to those PCs who haven't already noticed that a door made entirely of iron is an extremely rare thing, as is the armor that the mul guards wear. If you feel that the party really needs a heavy hint, tell them to turn to page 39—The Iron Door.

Emphasize the brutality of the guards and the weird nature of the dungeon, carved from the roots of the palace.

### *Dialogue*

"Move, prisoners! Faster, or you get the whip!"

"Don't tarry! The Red Moon Hunt awaits!"

"Here's your cell! Try to get some rest—you've got a busy day coming!"

"Don't think you are the first of the Forest Queen's guests to end up down here!"

**Outcome.** The PCs are escorted to a heavy stone door and shoved inside. Any resistance from the PCs will result in a severe response from the guards in the form of merciless strokes of the lash. None of the guards will elaborate on the Red Moon Hunt, and instead chortle knowingly among themselves if asked.

**Next.** Go on to 3B.

## Part Three: B—Scenes in the Dungeon

**Setup.** The PCs have been placed in a cell reserved for future victims of the Red Moon Hunt. As they encounter the various other occupants of the cell, show them the illustrations indicated.

**Start.** The PCs are not the only ones in Lalali-Puy's dungeon. The DM may use one or more of the following scenes. None are required, but the encounter with Semponius Asticles will provide the party with new information regarding the Mingon faction and their plot against Agis. This and the other encounters may also be used to provide the party with NPC allies during the coming hunt.

Players who have had characters killed earlier in the adventure may also be allowed to introduce other characters from their character tree as prisoners in Lalali-Puy's dungeon.

**Encounter.** Choose one or more of the following scenes.

**Renegade Halfling.** Have the players turn to page 15—Renegade Halfling. A dirty, grim-looking halfling sits in one filthy corner of the cell. If approached, he will speak to the characters in a disgusted tone. "So, more fodder for the tree-hugging nobles, eh? You're bound for the Red Moon Hunt as well, are you? Well, we're trapped in the same sandpit, so we might as well make the most of it. I've been well fed for the Hunt, so have no fear. My name's Sark."

If asked for more information about the Red Moon Hunt, Sark will respond, "Oh, I'm told that it's some sort of initiation for Gulg nobles. They set us loose in the forest, then hunt us. We'll just see how well they do against a halfling of the Kawuli tribe!" Sark, being a rather proud halfling, will not agree to directly accompany the party, but may appear during the Red Moon Hunt, distracting the hunters with taunts, and occasional shots from a short bow that he will steal from one of the less competent Gulg hunters.

*Sark, halfling hunter.* AL LN; AC 10 (-4 due to dexterity); MV 6; F8; hp 35; THACO 13; #AT 3/2 rounds; Dmg\*; Str 10; Dex 18; Con 15; Int 11; Wis 7; Cha 8. \*Sark has no weapon currently. During the hunt he will be armed with a stone short sword and a short bow (see above).

**Thri-kreen.** A tall, majestic mantis warrior sits impassively near the center of the room. If approached, it will speak in brief, clicking sentences.

"So... click... hunter becomes hunted, yes? No? Soft-shell humans hunt the great hunter... click-click... Hunter needs pack... This hunter has no pack now... click... You be my pack for hunt? Click... Maybe we hunt hunters, yes? No? Click-click."

If the PCs agree, the thri-kreen will accompany them during the Red Moon Hunt. Its name is Krr'ikk.

## Part Three: B—Scenes in the Dungeon (cont.)

*Krr'ikk, thri-kreen warrior.* AL N; AC 5; MV 18; HD 6+3; hp 40; THAC0 13 (+2 due to strength); #AT 5; Dmg 1d4/1d4/1d4/1d4/1d4+1\* (+4 due to strength); Str 18/76; Dex 14; Con 14; Int 10; Wis 12; Cha 13. \*Krr'ikk will not be given any weapons by the Gulg templars. During the hunt it will have to rely only on its natural weaponry.

**Elf prisoner.** Have the players turn to page 37—Elf Prisoner. An elf in filthy rags stands to his full height, contemplating a necklace in the form of a wire-frame pyramid.

“Curse the Gulg-dwellers and their wicked queen,” she says. “Dune runners consume their black souls.”

If approached, the elf woman will confide in the PCs that the hunters have an unwelcome surprise coming during the hunt. Her tribe, the Black Spears, is coming to rescue her, she says, and they will kill all the Gulg nobles who come after her. Whether this is true or not is up to the DM. If it is, a raid by elven tribesmen may be used as a convenient *deus ex machina* to get the PCs out of a jam. The elf woman is too proud to join the party during the hunt, and has a superstitious dread of revealing her name.

*Elf of the Black Spear Tribe.* AL CN; AC 10; MV 12; F5; hp 22; THAC0 16; #AT 1; Dmg\*; Str 12; Dex 13; Con 16; Int 12; Wis 10; Cha 13. Wild Talent: lend health; PS 15; Cost 4; PSP 24 \*The elf has no weapon currently. She will be given a bone dagger before the hunt.

**Human Merchant.** Tell the players to turn to page 4—Sylos. A portly human in the remains of what was once rich finery approaches the PCs. “I am Sylos of House Kulik,” he says, “a simple merchant. For some reason that blasted queen accused me of smuggling spell components. The very idea! I’m innocent, of course, but I’ve been condemned to this vile hunt of hers. I don’t stand a chance, of course. If you help me escape and get me back to my household, I can make it worth your while. Is it a deal?”

If the PCs agree, Sylos will accompany them during the hunt. He is not a whiner or particularly incompetent, but he is certainly no warrior, and his presence will slow the party down considerably. If the party helps him reach safety, he will be good to his word. His house is a small one (which is why Lalali-Puy could afford to harass him), but he will see to it that each character is paid 500 sp.

*Sylos, merchant of House Kulik.* AL LG; AC 10; MV 12; Tr8; hp 25; THAC0 17; #AT 1; Dmg\*; Str 10; Dex 11; Con 12; Int 16; Wis 15; Cha 16. \*Sylos has no weapon. He will be given an obsidian dagger before the hunt.



## Part Three: B—Scenes in the Dungeon (cont.)

**Semponius Asticles.** If the PCs helped Semponius attack the caravan, they are all incarcerated here together. If, on the other hand, the party was defending the caravan, Semponius will greet them warmly. Tell the players to turn to page 18 for an illustration. Read the following as his dialogue.

“Ah! We meet again! You were defending the caravan, weren’t you? Fine fight, that! I see that the Forest Queen’s well-known fickle nature has asserted itself. Ah, well, that’s the way of the world. What say you we combine forces? You’re all bully fighters! We can give those dratted Gulg nobles a run for they money!”

Semponius will go on to inform the PCs that Mington is an imposter, and has no connection with the Asticles family whatsoever. The necklace that the PCs brought Lalali-Puy was a bribe. It is an item of considerable value, although he has no idea what that value is.

If the party can avoid being sickened by Semponius’ insufferably jolly nature and agree to accompany him, he will help them to avoid several ambushes and other tricky situations and will himself prove to be a “bully” fighter. Later on, if they reunite him with his family, they will be suitably rewarded (see Epilogue).

*Semponius of Asticles, leader.* AL NG; AC 10 (-4 due to dexterity); MV 12; F6; hp 30; THAC0 15 (+1 due to strength); #AT 1; Dmg\*; Str 17; Dex 18; Con 11; Int 12; Wis 9; Cha 18. \*Semponius has no weapon. He will be given an obsidian shortsword before the hunt.

**Outcome.** If the DM wishes, the party now has several NPC allies. This group is taken from the dungeon the next night, and escorted to the Crescent Forest for the Red Moon Hunt.

**Next.** Proceed to 3C—The Red Moon Hunt.



## Part Three: C—The Red Moon Hunt

### **About the Red Moon Hunt**

The Red Moon Hunt is a rite of initiation for would-be Gulg nobles. On the one night of the year in which the moon Ral is alone and full in the sky, a group of slaves, armed with crude weapons, is released into the Crescent Forest, and a group of aspiring nobles is sent in after them. After the hunt, the Queen awards the winners with the highest number of slaves, as well as some to those who accomplished the hunt in a distinguished fashion. Those who have already become nobles often participate as well, for the “sport.”

While the slaves are only minimally equipped, there are no restrictions on what the nobles may carry, or how many attendants may accompany them. Despite this, there is great prestige in taking slaves with minimal equipment and few attendants. The greatest prestige is awarded to the Gulg noble who takes one or more slaves alone, with the same armament as the slaves themselves. Style often counts for more than substance in the Red Moon Hunt—an individual with a low number of slaves, who ventured alone and unarmored in to the forest, may earn more respect than another noble who ventured into the forest accompanied by hunting beasts and slaves, and succeeded in taking many.

### **PCs in the Hunt**

As the sun sets, party members are hustled out of the dungeon by a large number of heavily armed muls accompanied by a pair of high-level templars. They are shackled together, and taken outside the city limits and escorted to the edge of the Crescent Forest, where a Templar reads from a scroll in a sing-song voice. Read the following out loud.

The great, dark sun is just slipping beneath the horizon, and the vast disk of the moon Ral is rising alone as the templar speaks.

“Her Radiance, our beloved oba, the Forest Queen, Lalali-Puy—whose name you are not fit to utter—has, in her benevolence, given you, the condemned criminals and slaves of Gulg, a single chance for life and freedom.

“Behold! As the Red Moon rises, you shall be set loose in the Crescent Forest, and given a thousand pulse-beats of freedom before the nobles and aspiring nobles of Gulg are sent after you. Should one of these nobles capture you, your life is forfeit. If, on the other hand, you should survive the hunt until dawn, you shall be free, on the single condition that you never return to Gulg.

“Soon, the hunt shall begin. As a further symbol of our sacred oba’s greatness and mercy, you will each be provided with a weapon, which you may use to defend yourself in any way you choose. Now, prepare to depart. May you be blessed with swift and merciful death. In the name of the Forest Queen, begone!”

## Part Three: C—The Red Moon Hunt (cont.)

At this point, the prisoners are freed one at a time, given a stone, bone, or obsidian dagger or shortsword, and allowed to dash into the forest. Thri-kreen and half-giants, due to their formidable natural weaponry, will not be given weapons. Any prisoners who fail to run directly into the forest are instantly attacked and slain by overwhelming numbers of muls.

### DMing the Red Moon Hunt

At this point, the PCs are on their own, unarmored and armed with only the most minimal of weapons. The flowchart on the following page charts the course of the hunt, and enables DM to easily guide the PCs through the Crescent Forest.

Begin at the space marked "Start." Roll 1d10, and follow the arrow in the direction indicated. If you roll a 1-5, go to the left. If you roll a 6-10, go to the right. This will bring you to a circle marked with a letter. The letter governs what happens to the party. Play out whatever encounter or scene is indicated, then roll 1d10 again, progressing along the chart as described above.

The letters D, E, F, and G correspond to a number of events during the hunt, as described below. When a letter is indicated, turn to the appropriate section. Each entry gives several different possibilities—neutral, beneficial, or dangerous—for the party, which the DM is free to choose or modify.

**D—Scene.** A brief scene that provides color, mood, and possibly an important bit of information for the PCs.

**E—Location.** A specific location that may have good or bad effects on the party. The adventurers are free to investigate each location as they encounter it, or to avoid it altogether, unless otherwise specified.

**F—Encounter.** This may be a normal wilderness encounter, as listed under Forest in the DARK SUN™ *Monstrous Compendium* (for convenience, this table is reproduced in Section E), or it may be one of the pregenerated encounters listed in the section.

**G—Hunters.** The party encounters one of the hunting parties now stalking through the Crescent Forest. Statistics for several such groups or individuals are given in Section F, or the DM may come up with different ones.

When the entry marked "End" is reached, the PCs have survived the night, and are now in Nibeni territory. Go to 3H.

If the PCs are caught in a loop, taking high casualties, or seem to be getting through the hunt too easily as a result of good die rolls, feel free to move the action back or forward to any part of the flow-chart you desire.

### Allies

If the PCs befriended any of the other prisoners in the previous Encounter, they will be alternately helped and hindered by their new allies, as described in 3B.



Part Three:  
C—The Red Moon Hunt (cont.)

**The Crescent Forest**

As the largest stretch of uninterrupted greenery outside the Forest Spine, the Crescent Forest is jealously guarded by Lalali-Puy and her nobles. While defiling magic is practiced by the Forest Queen, she is careful to use Trees of Life to power her spellcasting, lest she damage her precious forest.

And a beautiful, terrible forest it is—thick, tangled vegetation, rich loamy soil, insects and birds everywhere. Here is Athas as it once was, and as it may yet be again. The isolated nature of the forest makes it a highly competitive environment, and each creature in it is prepared to fight to survive. Many life-forms not normally found elsewhere—water drakes, bog waders, cistern fiends, carnivorous plants, etc.—may be encountered here in abundance.

Releasing the slaves into the Crescent Forest during the Red Moon Hunt is no mercy. As many die from the forest's wildlife as from the hunters of Gulg. Few if any survive a Red Moon Hunt. The forest is also hard on the hunters; those who do not return are not mourned, for the lack of survival in the forest indicates that they were not destined to be nobles in the first place.

Part Three:  
Red Moon Hunt Flow Chart

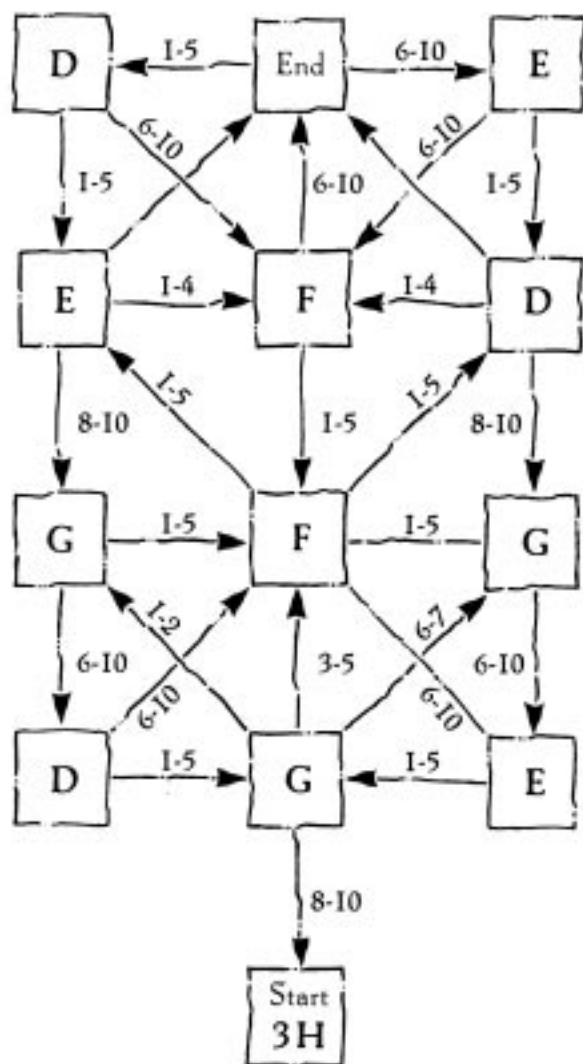

## Part Three: D—Scenes

The following brief scenes provide sights and sounds may or may not assist the party during the hunt. When the letter D is indicated on the Red Moon Hunt flowchart, select one of the scenes below.

**Minor Sounds.** The PCs hear something—the crack of a twig, the sound of a falling branch, hurried footsteps, the sounds of battle, the warbling call of a crodlu, hushed conversation, etc. The party has the chance to approach the sounds or move away from them. This may lead them into a normal encounter, a confrontation with hunters (see 3G) or other fleeing slaves (see 3F), or nothing at all, at the DM's discretion.

**Minor Sights.** A PC catches a glimpse of motion in the distance. Others may or may not have seen it. This may be used to keep the party on its toes, or it may actually lead to an encounter.

**Recent Passage.** The trees and undergrowth have been visibly disturbed, as if a large number of man-sized individuals have passed by. If the PCs follow the path, it may disappear, or it may lead them to other fleeing victims of the hunt, or even a party of hunters.

**Bodies.** The bodies of several muls and humans lie here. They are well equipped, indicating that they were from the retinue of a hunter. PCs may obtain clubs, bone swords and shields here if they desire, although the total number obtained can be limited by the DM.

**Signs of Battle.** Blood, torn up vegetation, and perhaps a discarded arrow or two litter a clearing. There are no bodies, but a tracker might be able to follow the individuals who took part in the fight, leading to other victims or to hunters.

**Spooked Herd.** A small group of wild or feral erdlu sits quietly in a clearing. Before the party can approach, they spook, rushing off in every direction. What this means is up to the DM. It may be an unnerving incident to make the party fearful, or it may be a warning that hunters or other dangerous opponents are approaching.

**Fleeing Slaves.** A small group of freed slaves, clad in rags, carrying their bone daggers, runs past, shouting, "Run! They're right behind us!" The DM should decide whether the slaves are really being pursued, and, if the party decides to follow them, whether the fleeing slaves disappear into the forest or join the party as NPCs.

## Part Three: E—Locations

These are specific places in the forest that may provide the party with assistance, or may get them in trouble. When entry D is indicated on the Red Moon Hunt flowchart, select one of the locations listed below and describe it to the party.

**Clearing.** A pleasant, grassy gap in the trees appears, shining silvery-red in the moonlight, a gentle breeze wafting the pleasant smell of exotic wildflowers. This may simply serve as a break in the hunt, or it may hold a group of slaves or hunters, taking a rest from the pursuit. In any event, the PCs are free to bypass it if they so desire.

**Forest Trail.** A hunter's or animal trail appears before the PCs. This trail may lead out of the forest, or it may simply be a convenient place for an ambush. Parties traveling along a trail may be attacked by hunters, encounter other slaves, or may set up an ambush of their own. If this is the case, select a hunting party from Scene G.

**Spring.** A wondrous sight greets the party--fresh, cool water gushing almost magically from the ground. The spring may provide the party with fresh water, it may be poisoned, or it may be an illusion or ambush by hunters.

**Hill.** The ground begins to slope upward. As the party climbs, the characters see that they are on a substantial rise, from that they can get a good view of the surrounding forest. This may be used to reconnoiter, check on the hunters' progress, or be used as a place to ambush pursuers. There is also a possibility that other slaves or hunters are using the hill for the same purpose.

**Cave.** Scrambling through rugged terrain, the party discovers an opening in the ground. This may simply provide a place to hide for a time, it may harbor a hostile creature, or it may lead to a network of tunnels that can emerge anywhere within the forest.

**Stream.** A narrow, rushing stream crosses the party's path. As above, the stream could be used as a source of fresh water, or may be used by the hunters for ambush. The stream may also contain a hostile creature such as an elemental, water drake, or cistern fiend.

**Fruit Tree.** A lush green tree bears brightly colored fruits. These may be nutritious (and the party is likely to be quite hungry by this time), or they may be poisonous, causing anything from minor discomfort to actual physical damage. If the fruits are poisonous, they should not be fatal, and should not cause more than 1d8 points of damage. A saving throw vs. poison should halve this damage.

**Hut.** A small thatch hut sits in the middle of the forest. It may be in disrepair, long abandoned, in which case it will at least offer shelter for a time, or it may be a hunter's cabin, in which case it may contain food, weapons or water. The DM may also decide that the hut is actually occupied by a hunter of other wilderness character such as a ranger, who may or may not be of assistance to the party.

## Part Three: F—Encounters

The PCs have a normal wilderness encounter. Use the encounter tables for Forest, located in the DARK SUN™ *Monstrous Compendium*, or select one of the pregenerated encounters that follow.

### Pregenerated Encounters

If the DM desires, the following pregenerated encounters may be used. Some may be used in combination with the locations table above.

**Other Slaves.** Another group of victims is encountered, also fleeing from the hunters. Roll 2d4 to determine the number encountered, then roll 1d10 on the following table to determine each slave's race. Consider the slaves to be first level with no armor and only bone daggers for weapons. If the DM wishes to make the encounter more useful or challenging, slaves of higher level may be encountered.

Roll	Race
1-3	Human
4-5	Elf
6	Halfling
7	Dwarf
8	M u l
9	Half-giant
10	Thri-kreen

Roll a standard encounter reaction (*Dungeon Master's Guide*, Chapter 11) to see what the slaves' attitude is toward the party.

**B'roh.** Have the PCs turn to page 8. This dangerous creature is one of the hunted, but it was released separately from the others. Confused and frightened, the B'roh will attack anyone he encounters.

**B'roh:** AL N; AC 10; MV 15; HD 5+3; hp 25; THAC0 15; #AT 4; Dmg 1d8+10; SA special; SD special; SZ H; ML 10; XP 650

**Bog Wader.** A shallow pool of apparently potable water harbors this horrific creature. If a PC stoops to drink the bog wader will attack in the fashion described in the DARK SUN™ *Monstrous Compendium*. If the party is attacked, instruct the players to turn to page 16.

**Bog wader:** AL CE; AC 4; MV 3, Sw15; HD 4+3; hp 13; THAC0 15; #AT 5; Dmg 1-3x4/1d4; SA Impale; SZ M; ML 11; XP 420



## Part Three: F—Encounters (cont.)

**Cistern Fiend.** What appears to be a spring with a pool of crystalline, drinkable water harbors one of these horrific predators. Nearly invisible in the water, the cistern fiend will immediately attack any characters who attempt to drink from the water. Characters so attacked receive a -3 penalty to their surprise rolls. If the party is attacked, instruct the players to turn to page 44.

*Cistern Fiend:* AL N; AC 0; MV 12; HD 10+10; hp 56; THAC0 9; #AT Special; Dmg Special; SA Special; SD Regeneration; SZ G; ML 15; XP 10,000; Psionics: Sciences—mindlink, psionic blast; Devotions—contact, ego whip, inflict pain, life detection (no cost), mind thrust, synaptic static, thought shield; Att Modes: PsC, MT Def Modes: IF, MB, TS; Score 16; PSPs 100.

**Dwarf Banshee.** The product of a dwarf slain in the Red Moon Hunt before he could complete his focus, this sad, angry creature rises up each year during the hunt, exacting vengeance upon hunters and hunted alike.

*Dwarf Banshee:* AL NE; AC 0; MV 12; HD 10; hp 60; THAC0 11; #AT 1; Dmg 1d2+10; SA Gaze, malediction, psionics; SD Steel or +1 or better to hit; SZ M; ML 17; XP 4,000; Psionics: Sciences—death field, shadow form; Devotions—body weaponry, cause decay, chemical simulation, double pain; Att Modes: nil; Def Modes: IF, MB; Score 15; PSPs 110.

**Esperweed.** Experienced wilderness adventurers who are keeping an eye out for beneficial flora will notice a cluster of these bright red flowers. As described in the DARK SUN™ *Monstrous Compendium*, Esperweed adds the equivalent of 5 levels to any psionist who eats its root, as well as increasing all power scores by +1. These effects last only one turn. These plants will yield 2-8 roots.

**Halflings.** A small party of 2-12 halfling hunters is in the forest, and has been having fun picking off Red Moon Hunt participants—hunters and victims alike. The halflings will shoot at the party from ambush, then attack as a group. The halflings' morale is brittle; check each round after any halfling loses half or more of his hit points.

*Halflings:* AL LN; AC 7; MV 6; HD 1; hp 4; THAC0 19; #AT 1; Dmg 1d6 (shortswords)/1d6 (short bows); SD Special resistances; SZ S; ML 9; XP 65

**Half Giant.** A lone half-giant wanders aimlessly through the forest, somewhat confused at the purpose of the Red Moon Hunt. Currently the half-giant is at a true neutral alignment, mostly due to the fact that there is no one around for him to emulate. If approached in a friendly manner, he will begin to move toward a lawful alignment, and speak politely to the party, telling them if any hunters are near, and then wander off into the forest. If the party attacks, or approaches in a stealthy manner, the giant will immediately go extremely chaotic and attack them with maximum noise and fury, attracting the attention of at least one hunting party (see 4G).

## Part Three: F—Encounters (cont.)

**Half Giant:** AL N; AC 10; MV 15; HD 3+12; hp 26; THAC0 17; #AT 1; Dmg 1d6; SZ H; ML 11; XP 120

**Muls.** The PCs encounter 3-12 muls. These may be slaves, or ordinary muls traveling through the forest. Whatever their origin, the muls are hostile, and will attack immediately if encountered.

**Muls:** AL N; AC 10; MV 12; HD 1+4; hp 8; THAC0 19; #AT 1; Dmg 1d6; SZ M; ML 16; XP 35

**Plant, Carnivorous-Blossomkiller.** One of these vast killer plants occupies the region in which the party is walking. Any character who treads on a root will be attacked by a spray of quills, as described in the DARK SUN™ *Monstrous Compendium*. Those who fail their saving throw vs. paralysis are paralyzed for two turns while the blossomkiller tries to consume them.

**Blossomkiller:** AL N; AC 9; MV 0; HD 9; hp 42; THAC0 11; #AT 1; Dmg 1d6; SA Paralysis; SD Special; SZ H; ML nil; XP 2,000

**Sloth, Athasian.** A group of 1-4 of these rapacious beasts is encountered. Lurking the thick vegetation, the sloths attack as soon as the party passes. If encountered this fashion, instruct the players to turn to page 48.

**Athasian Sloths (4):** AL N; AC5; MV 24; HD 11; hp 48, 40, 35, 32; THAC0 9; #AT 3; Dmg 2d4x2/2d10; SA Surprise; SD Resistant to poison; SZ L; ML 9; XP 2,000

**Zombie Plant.** The party encounters a plant that bears rich red berries. Any character who approaches the plant will be subjected to its attraction ability; if the plant succeeds in attracting the character, he or she will immediately want to eat berries from the plant. PCs who eat its berries must save vs. poison (-1 for every berry eaten) or fanatically defend the plant from anyone nearby, including other party members!

**Zombie Plant:** AL N; AC 7; MV 0; HD 3; hp 11; THAC0 17; #AT 0; Dmg 0; SA Berries; SD Berries; SZ M; ML nil; XP 120; Psionics: Devotions-attraction; Att Modes: nil; Def Modes: nil; Score 8; PSPs 20.

## Part Three: G—Hunters

The characters have encountered one of the numerous hunting parties that are now stalking them through the Crescent Forest. When an encounter with hunters is indicated, select one of the parties below. If the DM desires, new groups of hunters may be generated using the groups below as models.

**Tovril the Green.** This vain would-be nobleman leads a small army of slaves, hoping that his sheer number of kills during the hunt will offset his utter lack of skill. In Gulg, Tovril is widely considered a buffoon, and many nobles laugh at him behind his back for his unorthodox hunting procedures. If he is encountered, tell the players to turn to page 45.

Four halflings precede Tovril, searching for prey, then report back to their master if they catch sight of fleeing slaves. Tovril will then send his muls forward to deal with the slaves while he watches from the comparative safety of his Inix. He has participated in nine hunts, and has yet to attain the nobility, although he has not yet even considered dispatching with his unusual hunting style.

*Tovril the Green.* AL CE; AC 7; MV 12; F7; hp 31; THAC0 13. #AT 3/2 rounds; Dmg 1d8 (bronze battleaxe); Str 13; Dex 14; Con 11; Int 9; Wis 7; Cha 6.

*Halflings (4):* AL LN; AC 7; MV 6; HD 1; hp 6, 4, 4, 3; THAC0 19; #AT 1; Dmg 1d6 (clubs); SD Special resistances; SZ S; ML 9; XP 65

*Muls (8):* AL N; AC 10; MV 12; HD 1+4; hp 12, 11, 10, 10, 9, 8, 8, 6; THAC0 19; #AT 1; Dmg 1d6; SZ M; ML 16; XP 65

**Yandor of the Bow.** One of the finest archers in Gulg, Yandor hunts armed only with his bow and a bone dagger. A skilled tracker, Yandor favors stealth; he likes to sneak close to a party, loose a few poisoned arrows, then vanish. He will continue to shadow the party, checking to see if his arrows have had any effect, and launching more if they haven't. He will also use his clairsentience to hear the party from a distance and gain clues as to their location. If the party actually manages to catch 5 glimpse of Yandor, tell the players to turn to page 10.

Anyone struck by Yandor's arrows must save vs. poison or take 4d10 points of damage immediately, and 1d6 points per turn for 1d6 turns thereafter. A successful save halves the initial damage, and eliminates the subsequent damage altogether.

Yandor is accompanied by two trusted slaves whose primary job is to dress and carry his victims back to the edge of the forest. They are not permitted to participate in the hunt in any way, although they are very loyal, and will fight if their master is in danger of being killed.

*Yandor of the Bow.* AL LN (evil tendencies); AC 10 (-3 due to dexterity); MV 12; F14; hp 78; THAC0 7(+3 due to strength); #AT 2; Dmg 1d8 (steel scimitar +7 due to strength)/1d8 (longbow + poison—see above); Str 19; Dex 17; Con 13; Int 11; Wis 13; Cha 16. Wild Talent: Clairaudience; PS 10; Cost 6+4/round; PSPs 78.

## Part Three: G—Hunters (cont.)

**Durrus, human slave.** AL LN; AC 10; MV 12; F8; hp 35; THAC0 13 (+1 due to strength); #AT 3/2 rounds; Dmg 1d6 (club; +1 due to strength); Str 17; Dex 12; Con 15; Int 9; Wis 10; Cha 8.

**Margos, dwarfslave.** AL N; AC 10; MV 9; G10; hp 76; THAC0 11 (+3 due to strength); #AT 3/2 rounds; Dmg 1d6 (club; +8 due to strength); Str 20; Dex 14; Con 17; Int 9; Wis 9; Cha 5.

**Iynara.** A young, ambitious woman with a talent for the hunt, Iynara rides a specially trained crodlu through the forest. She has little patience for hit-and-run tactics, and prefers to attack all-out, slaying as many slaves as she can and driving the rest off. If threatened, she will flee, then return later to pick up the bodies of her victims.

**Iynara.** AL LE; AC 10 (-4 due to dexterity); MV 12; F12; hp 60. THAC0 9; #AT 3/2 rounds; Dmg 1d8 (obsidian broadsword); Str 13; Dex 18; Con 14; Int 16; Wis 11; Cha 19. Wild Talent: All-around vision (8), catfall (16); danger sense (8); PSPs 90.

**Crodlu:** AL N; AC 4; MV 24; HD 4+4; hp 25; THAC0 15; #AT 5; Dmg 1d4x2/1dbx2/1d8; SA Grapple; SZ L; ML 6; XP 270

**Warakari Redeye.** Another skillful would-be noble, Warakari revels in the thrill of the hunt, but is a poor tracker himself. He lets his slaves and retainers do the actual tracking, then moves in for the kill alone. If he appears to be threatened, his slaves and companions will move to assist him. Otherwise, he hates to share his kills. If attacked by Warakari, tell the players to turn to page 13.

Warakari's other flaw is his considerable overconfidence. A good fighter himself, he is confident that he can handle his slaves if they should turn on him during the hunt. If the DM desires to get the party out of a jam, Warakari's slaves may decide to overwhelm their master and escape. Some may actually join the PCs.

**Warakari Redeye.** AL NE; AC 9; MV 12; F10; hp 62; THAC0 11; #AT 3/2 rounds; Dmg 1d6 (obsidian shortsword)/1d6 (short bow); Str 15; Dex 13; Con 17; Int 12; Wis 15; Cha 14.

**Human slaves (10):** AL N; AC 10; MV 12; HD 1; hp 8, 8, 7, 6, 5, 5, 5, 4, 3, 3; THAC0 19; #AT 1; Dmg 1d6 (clubs); SZ M; ML 12; XP 15

**Ulyua, human slave tracker.** AL LN; AC 10 (-3 due to dexterity). MV 12 F5 THAC0 16; #AT 1; Dmg 1d6 (stone shortsword), Str 14; Dex 17; Con 12; In: 13; Wis 10; Cha 10.

## Part Three: G—Hunters (cont.)

**Shala the Hunt Mistress.** Lalali-Puy's chief hunter participates in the Red Moon festivities every year, more to demonstrate her superiority than for any other reason. She hunts alone, with only the most minimal of equipment. Despite this, Shala alone will be more than a match for the entire party, using her formidable combat skills and psionics to best advantage. Should she be threatened, the DM should allow her to escape by utilizing her superior invisibility. If the PCs have not yet encountered Shala, or if they wish to refresh their memories, instruct the players to turn to page 41.

*Shala, Hunt Mistress of Gulg.* AL NE; AC 10 (-4 due to dexterity); MV 12; F15/Ps10; hp 66; THAC0 6 (+1 due to strength); #AT 2; Dmg 1d8 (steel scimitar; +1 due to strength)/1d8 (longbow); Str 17; Dex 20; Con 18; Int 19; Wis 15; Cha 13. Psionics: Sciences (5)—disintegrate (11), mindlink (10), psychic crush (11), superior invisibility (14), telekinesis (12); Devotions (15)—animate object (16), attraction (11), awe (11), ballistic attack (16), ego whip (12), ESP (11), inflict pain (14), invincible foes (12), invisibility (14), levitation (12), life detection (17), mind thrust (13), molecular agitation (15), psionic blast (10), soften (19) Att Modes: PsC, EW, MT, PB; Def Modes: M-. TS, MB, IF, TW; PSPs 227.

## Part Three: H—Hunt's End

**Setup.** After the PCs have had a long, dangerous, and possibly fatal night, they emerge on the Nibeneni side of the Crescent Forest just as dawn is breaking.

Alternately, this encounter may also be used to rescue the party if it looks as if they are going to be wiped out during the Red Moon Hunt.

**Start.** Read the following out loud:

Overhead, the sky begins to lighten. Dawn is coming. The evil, dark sun of Athas never seemed so welcome. You have survived the hunt, and you are free!

Unfortunately, your freedom is short-lived. As you emerge from the forest into a clearing, you are confronted by a large number of well-armed warriors. A woman in templar garb steps forward.

"Halt!" she shouts. "I am the templar Marika of Nibenay! You are prisoners of my liege the Shadow King!"

**Encounter.** Have the players turn to page 5. The Shadow King has caught wind of the PCs mission and of their fate, and has sent his warriors into the forest to retrieve them. He has put the expedition under the command of Marika, one of his most trusted templars.

The warriors are Nibenay's finest. They are accompanied by several defilers, who will use whatever spells are required to subdue the party, despite its effect on surrounding vegetation. The Nibenay force has been given orders to capture the party alive. To this end, they will give the party a chance to surrender before attacking. Spells such as sleep will be used to render party members unconscious, while warriors are armed with sleep-poisoned arrows. Any character hit by one of these arrows must save vs. poison or fall asleep. The arrows do 1d4 points of damage in addition to the poison effects.

**Role-playing.** The Nibeneni are not especially hostile to the party, but they will not allow them to escape.

### *Dialogue*

"We mean you no harm! We know you are enemies of the Forest Queen, and only wish to escort you to meet with our king!"

"Give yourselves up, for your own sakes!"

"This is your final warning. We wish no harm to come to you, but will do what we have to!"

## Part Three: H—Hunt's End (cont.)

### Statistics.

*Nibeni warriors (16):* AL N; AC 8; MV 12; HD 1+2; hp 6; THAC0 15; #AT 1; Dmg 1d6 (shortswords)/1d4 + poison (short bows; see above) SZ M; ML 13; XP 65

*Nibeni defilers (3):* AL NE; AC 10; MV 12; D6; hp 12, 14; THAC0 19; #AT 1; Dmg 1d4 (bone daggers) SZ M; ML 15; XP 650 Spells—First level: *detect magic, magic missile (x2), shield*; Second level: *flaming sphere, invisibility*; Third level: *lightning bolt (x2)*.

*Marika, templar of Nibenay.* AL NE; AC 8 (-3 due to dexterity); MV 12; Te12; hp 48; THAC0 14; #AT 1; Dmg 1d6 (stone-headed mace); Str 10; Dex 17; Con 11; Int 16; Wis 17; Cha 15. Spells—First level: *create water, cause light wounds, detect magic, purify food & drink*; Second level: *aid, dust devil, flame blade, spiritual hammer*; Third level: *animate dead, dispel magic, prayer*; Fourth level: *giant insect, neutralize poison, rejuvenate*; Fifth level: *sandstorm*.

**Reaction.** As noted, the Nibeni warriors will give the PCs every chance to surrender peacefully. If the party fights, the Nibeni will attempt to capture them unharmed, but will not be above killing or badly wounding characters. If the PCs try to flee back into Gulg territory, they will discover that the Nibeni have circled around behind them.

**Outcome.** This encounter must end with the PCs—under protest if necessary—on their way to Nibenay for a fateful meeting with representatives of the mysterious Shadow King.

**Next.** Go to Part Four, Prisoners of the Shadow King.

## Part Four: Back to Gulg A—Prisoners of the Shadow King

**Setup.** This scene takes place after the PCs have been taken by the warriors of Nibenay.

**Start.** Tell the players to turn to page 7 for a picture and brief description of Nibenay. Read the following out loud:

You are escorted through the lush growth of the Crescent Forest. After several hours of marching, you reach the city of Nibenay. It is a vast, walled settlement, with every structure intricately carved with dancing figures, fantastic monsters, and elaborate scenes. In the center of the city you see the fantastic form of the Shadow King's palace, carved in the shape of an enormous head—the bust of the ruler, you have heard.

**Encounter.** This encounter serves primarily to introduce the PCs to Nibenay, and to give them a little local color as they travel through the streets. Nibenay is all abustle with citizens, and its wide streets are all paved. Nibenai stare curiously at the PCs—foreigners are a curiosity in Nibenay.

Characters who look down will note that even the paving stones are carved individually, although most of their decorations have been worn away by centuries of traffic.

As the PCs approach the palace, one of the king's female templars snaps, "No mortal may enter the Shadow King's demesne. His majesty will speak with you in one of his lesser palaces." She then leads the characters to a vast, intricately carved building of many rooms.

**Role-playing.** The templars and warriors are all very businesslike, answering questions with monosyllables, or telling the PCs that all their inquiries will be answered presently.

**Reactions.** The templars will continue on in the manner described above unless the PCs do anything foolish such as attack or attempt to escape, in which case they will render the offending characters helpless in the most efficient manner possible.

### **Dialogue.**

"Hurry along. The Shadow King awaits your arrival."

"Silence. All questions will be answered by the Shadow King."

"Behold, the home of our illustrious monarch. All hail the Shadow King!"

**Outcome.** Except in the highly unlikely event that the party decides to fight (in which case they will be rendered helpless and carried on), the group proceeds into the minor palace for its meeting with the Shadow King.

**Next.** Proceed to 4B.



## Part Four: B—Meeting the Shadow King

**Setup.** This scene begins in the Shadow King's minor palace, outside of his walled inner city. Tell the players to turn to page 34 for a picture of the interior and the Shadow King's talking statue.

**Start.** Read the following out loud.

The interior of the palace is every bit as impressive as its exterior. You find yourself thinking that if this is a "lesser" palace, the Shadow King's main palace must be grand indeed.

At one end of the chamber is a massive statue. You recognize its face as that of the Shadow King from the gigantic bust that makes up his palace.

With awe and horror, you realize that the statue's eyes glow with an eerie blue light. Its stone lips begin to move, forming words in a deep, booming voice.

"So, you are the Forest Queen's enemies. Tell me of your mission. Do not lie, or you will be instantly destroyed."

**Encounter.** As the Shadow King is rarely, if ever, seen outside his palace, and no lesser mortals are allowed in, he must do all his business through intermediaries such as the mighty statue to which the PCs are now speaking.

The Shadow King is not kidding. His psionic skills are active even here, and he will know if a character is lying. The PCs must tell their story without falsehood, or a party member will be struck with 5d10 points of damage from a white-hot beam originating in the statue's eyes. If the PC survives this warning shot, any further lies will be punished with 10d10 points of damage.

Word of the Astician plot and Lalali-Puy's role in it has reached Nibenay, and the Shadow King is concerned. He has suspicions about the Forest Queen's necklace, and the PCs' story has confirmed it.

At the conclusion of the party's story, the statue will be silent, and the glow in its eyes will dim, but not vanish altogether. It is almost as if the statue is thinking.

After several moments of silence, the eyes will glow brighter, and the statue will speak.

"You have been duped, foolish mortals," it says in a voice that combines amusement and contempt. "The necklace you brought to Lalali-Puy, may zhakals feed upon her death-agonies, is a powerful device that was made for her many centuries ago. It was said that it could double both her magical and psionic abilities, but before she could activate the device, The Dragon arrived and demanded the necklace for his own use. She had no choice but to obey, or risk destruction.

"The necklace is keyed to Lalali Puy's magical aura alone, and will work for no one else, not even The Dragon. He must have discarded it as soon as he discovered that it would not work. Now, after all these years, it has returned to us.

"The Mingons are even bigger fools than you are. They hope that this gift will bring Lalali-Puy's favor upon them, for they plan to overthrow Tithian and offer Tyr up to her as a vassal state. They hope that out of gratitude, Lalali-Puy will grant their faction rulership over the city. Ha! Sorcerer-monarchs do not become powerful by trusting traitors! They will be destroyed along with anyone else who the Forest

## Part Four: B—Meeting the Shadow King (cont.)

Queen finds troublesome! I do not like either this Tithian or his toadies the Asticles, but I see that it is in my interest to support them in this matter.

“I see from your mental images of Gulg’s dungeons that she has placed the item there under guard. We are fortunate, at least, that the item is dormant after all these centuries. It will require extensive magical and psychic procedures for its power to be reawakened.”

The statue pauses, and its glowing blue eyes stare directly at the party. “You have knowledge of Lalali-Puy’s dungeons! You know where the device is kept! I charge you to return to Gulg and destroy the item, or be responsible for the destruction of both “Nibenay and your beloved Tyr!”

**Role-playing.** The Shadow-King is everything a sorcerer-monarch should be—imperious, bombastic, evil, and used to getting his way. He will not tolerate impertinence or defiance, but will answer any questions that the party has.

**Reactions.** The party must discuss and respond to the Shadow King’s offer. He will agree that the characters may keep any loot they happen to pick up along the way, and as soon as they complete their mission they will be free to return to Tyr.

Should the party refuse, the Shadow King will be upset, threatening them with dire consequences. Should the characters continue to hold out, the king will resort to placing a *geas* upon the party, to compel them to do his bidding. Note that compulsion of this sort should be a last resort, only after the DM determines that the players are completely dead-set against the idea.

**Outcome.** By the end of this scene the party will have agreed, or been compelled to agree, to return to Gulg to destroy Lalali-Puy’s necklace.

Once the party has agreed—one way or the other—to carry out the task, the Shadow King will speak again.

“You may eat and drink, and rest for a day. Return at this time tomorrow, and I will send you to Gulg.”

The PCs will be allowed to refresh themselves and rest. Templars will heal any damage the party has taken. The Nibeni will give the PCs stone or bone weapons to replace any lost equipment, but cannot replace armor or magical items (see C—Return to the Dungeons). As the Shadow King has declared the characters his agents, the templars are willing to look the other way if PC spellcasters wish to memorize spells or go in search of spell components.

If Sempontius Asticles is with the party, he will be held, alive and comfortable, as a guarantee of the party’s return. If they succeed in their mission, the entire group will be escorted back to Tyr. While the Shadow King is not fond of the freed slaves and others who have taken control of Tyr, it is in his interest to stay on their good side. For the time being, anyway.

If the PCs try anything funny, such as escaping or defecting to Lalali-Puy, Sempontius will be killed and the party will be framed for the crime, making them hunted fugitives from three Athasian city-states.

**Next.** Proceed to 4C.

## Part Four: C—Return to the Dungeons

**Setup.** This scene takes place one day after the party's meeting with the Shadow King. The PCs should all be rested and fed, with wounds healed and spells renewed.

The Nibeni will provide weapons and equipment to PCs who require them. Have each player roll on each of the following tables for each character. Only one roll per table is allowed for each PC, so if a useless item is obtained, too bad. PCs can, of course, swap equipment. The equipment obtained is of average or poor quality, and will not be distributed until immediately before the party leaves for Gulg.

### Weapons (1d8)

- 1: Obsidian dagger (dmg 1d4-1; -2 to hit)
- 2: Bone dagger (dmg 1d4-1; -1 to hit)
- 3: Wooden club (dmg 1d6-2; -3 to hit)
- 4: Obsidian short sword (dmg 1d6-2; -2 to hit)
- 5: Wood/obsidian club (dmg 1d8-8; -2 to hit)
- 6: Bone/obsidian club (dmg 1d8-1; -1 to hit)
- 7: Bone short sword (dmg 1d6-1; -1 to hit)
- 8: Bone broadsword or axe (dmg 1d8-1; -1 to hit)

### Armor (1d6)

- 1: None
- 2: Small shield (AC9)
- 3-4: Padded armor (AC8)
- 5-6: Leather armor (AC8)

**Start.** The PCs return to the Shadow King's minor palace. Several templars are there, and the talking statue is fully active, its eyes glowing an especially bright blue. Read the following out loud.

As soon as you approach, the statue speaks. "Lalali-Puy's magical defenses are low as she prepares to fully activate her necklace. I will be able to teleport you into her dungeons, but finding and destroying the item will be up to you. I will be aware when the item is destroyed, and will teleport you back to Nibenay at that time. Stand in front of this statue."

**Encounter.** The PCs must stand near the Shadow King's statue in order to be teleported. As soon as they are in position, the statue's eyes glow brighter and brighter, finally coalescing into a pair of beams that shoot out of the eyes to envelop the party in a blinding blue haze.

There is a moment of disorientation and dizziness as the party feels the sensation of traveling at extremely great speed. Then, the blue glow dissipates, and the party sees the familiar shapes of Gulg's dungeon.

**Outcome.** The PCs are now back in Gulg. They must now navigate through the dungeon in order to find the room where Lalali-Puy's necklace is held.

**Next.** Proceed to 4D, and the dungeon flow-chart.

Part Four:  
Dungeon Flow Chart

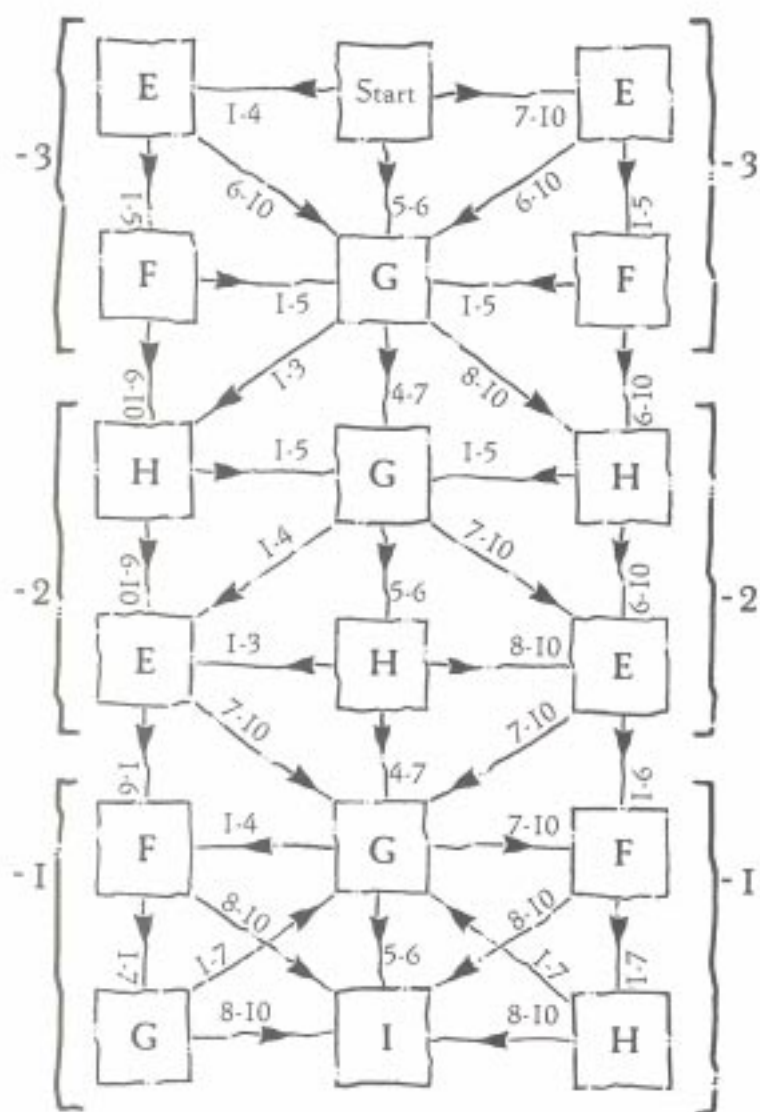

## Part Four: D—The Search

### Dungeon Flow Chart

This section plays similarly to the Red Moon Hunt. On the following page you will find a flow chart. Begin at the circle marked "Start, and roll 1d10. Follow the arrows as you did during the Red Moon Hunt.

There is one additional rule to simulate the PCs' memories of the dungeon. Before you roll 1d10 to determine which area you will move to, have each PC roll 1d20 vs. intelligence. Each section of the flow chart corresponds to a modifier (listed along the right edge of the chart- -1, -2, -3). This simulates the fact that the farther they are from their goal, the worse the PCs memories will be. Subtract this modifier from the characters' 1d20 rolls. For each successful roll vs. intelligence, add one from the 1d10 roll on the chart. The better the intelligence rolls, the faster the party will find the necklace's hiding place.

Each d10 roll brings you to a space marked with a letter. This letter corresponds to a scene. These scenes are described below.

**E—Guards.** Several guards are encountered. If any are allowed to escape they will raise the alarm. Encounters after the alarm has been raised will be more deadly.

**F—Other Encounter.** The PCs encounter one of the dungeon's other inhabitants.

**G—Room.** A side-room or opening in the corridor is encountered. The DM may make this encounter optional if the party is too badly beaten up.

**H—Trap.** The dungeon bristles with traps for escaping convicts. Guards are aware of the location of all (well, most anyway) the traps and are always careful to avoid them.

**I—End.** The PCs have found the room where the necklace is kept. Proceed to 5E in order to play out the final confrontation with Lalali-Puy's minions.

### Encounters in the Dungeon

**E-Guards.** The PCs encounter 2d4 of Lalali-Puy's human guards if the alarm has not yet been raised. If the PCs allow even one of the guards to escape them, he will immediately raise the alarm.

If the alarm has been raised, there will be 2d8 normal guards, 1d4 officers, and 0-2 templars.

**Gulg Guards:** AL N; AC 8; MV 12; HD 2; hp 8; THAC0 18; #AT 1; Dmg 1d6 (maces); SZ M; ML 11; XP 35

**Officer:** AL NE; AC 7; MV 12; HD 5; hp 20; THAC0 16; #AT 1; Dmg 1d6 (mace); ML 13; XP 175

**Templar:** AL NE; AC 8; MV 12; HD 5; hp 15; THAC0 18; #AT 1; Dmg 1d6 (mace); SZ M; ML 13; XP 270

Spells: First level: *cause light wounds, detect magic, commend*; Second level: *aid,*

## Part Four: D—The Search (cont.)

**F—Other Encounter.** The PCs encounter a minion of Gulg's dungeon. When this result is obtained, select one of the encounters from below.

**Agony Beetles.** Several of these deadly insects have escaped from one of the dungeon's torture chambers. The beetles will drop from the ceiling onto the characters, and attack as described in the DARK SUN™ *Monstrous Compendium*.

**Agony Beetles (3):** AL N; AC 6; MV 3, Fl6, Jp3; HD 1+5; hp 12, 11, 9; THAC0 19; #AT 1; Dmg 1; SA Spinal tap, psionic drain; SZ T; ML 7; XP 270; Psionics: Sciences—mindlink; Devotions—contact, cannibalize other (no cost), psionic drain (no cost during spinal tap); Att Modes: nil; Def Modes: M-; Score 15; PSPs 30.

**Rock Golem.** This sorcerous automaton has been left in the passage to guard against intruders. It will attack the party automatically and never check morale.

**Rock Golem:** AL N; AC 4; MV 6; HD 10; hp 50; THAC0 11; #AT 1; Dmg 2d10; SD Special; SZ L; ML 20; XP 3,000

**Cerebral Parasites.** Unknown to the jailers, a swarm of near-invisible parasites has occupied this section of the dungeon, feeding off the psionic powers of those who pass nearby.

**Cerebral parasites (6):** AL N; AC nil; MV nil; HD nil; hp nil; THAC0 nil; #AT 0; Dmg 0; SA Psionic; SD Only affected by cure disease spell; SZ T; ML nil; XP 35; Psionics: Sciences—Probability travel; Devotions—Ectoplasmic form, immovability; Att Modes: nil; Def Modes: nil; Score 18; PSPs Unlimited.

**Brain Mole.** One of these creatures is tunneling in the roots of the great Agafari tree, attracted by the psionic activities in the palace.

**Brain Mole:** AL N; AC 9; MV 1, Br3; HD 1 hp; THAC0 nil; #AT nil; Dmg nil; SA Psionic; SD Psionic; SZ T; ML 6; XP 35; Psionics: Sciences—mindlink, mindwipe (30 foot range); Devotions—amplification (no cost), contact, mind thrust, psionic sense; Att Modes: MT Def Modes: M-; Score 12; PSPs 100.

**Centipedes.** A swarm of 2-24 giant centipedes is hiding in this section of the corridor. They will emerge to attack anyone who disturbs their privacy. There is an additional 25% chance that 1-4 megalocentipedes are nearby, and will attack along with its smaller brethren.

**Giant centipedes:** AL N; AC 9; MV 15; HD 2 hp; THAC0 20; #AT 1; Dmg nil; SA Poison; SZ T; ML 6; XP 35

**Megalocentipedes:** AL N; AC 5; MV 18; HD 3; hp 15; THAC0 17; #AT 1; Dmg 1-3; SA Poison; SZ M; ML 10; XP 175

## Part Four: D—The Search (cont.)

**Sitak.** A single bird waits in the trees. It was the pet of a Gulgese merchant, but escaped. It knows roughly twenty words of common. See Story Book for MC entry.  
**Sitak:** AL N; AC 8; MV 3, 18 Fl (C); HD 1-3 hp; hp 2; THAC0 20; #AT 2; Dmg 1 hp/1 hp; SZ T; ML 3; XP 15; Psionics: Sciences—mindlink; Devotions—contact; Score 20; PSPs 5.

**G—Room.** Room encounters may either be optional—the PCs find a door and have the option to open it—or mandatory, in which case the PCs must pass through the room in order to continue.

**Guardpost.** This room contains 2d6 human guards. There is a 25% chance that there is an officer in addition, and a 10% chance of a templar.

**Gulg Guards:** AL N; AC 8; MV 12; HD 2; hp 8; THAC0 18; #AT 1; Dmg 1d6 (maces); SZ M; ML 11; XP 35

**Officer:** AL NE; AC 7; MV 12; HD 5; hp 20; THAC0 16; #AT 1; Dmg 1d6 (ace); ML 13; XP 175

**Templar:** AL NE; AC 8; MV 12; HD 5; hp 15; THAC0 18; #AT 1; Dmg 1d6 (ace); XP 270

Spells\*: First level: *cause fight wounds, detect magic, command*; Second level: *aid, spiritual hammer*

\*The DM may replace these spells with any that are deemed more appropriate, if desired.

**Storage.** Various supplies are stored here, some of which may be of assistance to the PCs. Sacks of dried food grains such as wheat and rice are stored here, along with dried meat, preserved fruits and vegetables, and other items needed for times of shortage or war. Some ordinary weapons, such as bone or obsidian daggers and spears may be found here also.

If the party is in need of healing, this room might be a good spot to place a few *fruits of healing*.

**Cell.** This is a standard Gulg dungeon cell, built into the wood of the agafari roots. These doors are generally locked or bolted from the outside. Cells may be empty, or contain prisoners, in which case the DM should generate an appropriate victim of Lalali-Puy's justice. The prisoners in the cells will not be in good physical shape (they were all sent out on the Red Moon Hunt), and will not be capable of assisting the party combat, psionics, or magic. They may, however, have some information on the layout of the dungeon. If the party asks the right questions, simulate the additional information by jumping a square or more ahead on the dungeon flowchart.

**Abandoned.** The PCs have entered an abandoned room or section of the dungeon. In this case, "abandoned" simply means abandoned by Lalali-Puy's followers. This room may or may not be actually occupied. If the DM wishes it to be occupied, select occupant from the "Encounter" section above.

## Part Four: D—The Search (cont.)

**Sealed.** This room or section has been, for various reasons, sealed up and isolated from the rest of the dungeon. The DM may allow the PCs to bypass the sealed section, go back one square on the dungeon flow chart, and roll again. Alternately, the DM may tell the players that there is no other route that they can find, requiring them to go through the sealed room.

The sealed-off section will have a locked wooden door, stone wall, or barricade blocking access to and from the area. The PCs will have to figure out a way of getting through the barrier in order to continue.

Once past the barricade, the DM should determine exactly why the section was sealed, and what, if anything, lies ahead. Select from the following suggestions or come up with something on your own.

**Nothing.** Self-explanatory. The section is dusty and empty, with no apparent reason for the abandonment.

**Old Bones.** Rebellious prisoners, slaves, or guards were walled up here. The section is filled with bones in various states of contortion. The bones may harbor scavengers and parasites, as well. If you desire, select from the following to determine what sort of scavengers the PCs encounter.

*Ankheg (1-6):* AL N; AC 2/4 underside; MV 12/Br 6; HD 1d6 +2; hp 6; THAC0 16; #AT 1; Dmg 3d6 (crush) + 1d4 (acid); SA Squirt acid; SZ H; ML 9; XP 1,400

*Giant Centipedes (2-24):* AL N; AC 9; MV 15; HD 2; hp 10; THAC0 20; #At 1; Dmg nil; SA poison; SZ T; ML 6; XP 35

*Giant Rats (5-50):* AL N; AC 7; MV 12; HD 1d4; THAC0 20; #AT 1; Dmg 1-3; SA Disease; SZ T; ML 6; XP 15

*Insect Swarm:* AL N; AC 8; MV 6/Fl 18; HD 1hp/20 insects; hp special; THAC0 special; #AT 1; Dmg 1; SZ special; ML 6; XP special

**Old, Hostile Bones.** The bones are old and in the various contorted positions described above, but they are not entirely dead. Select from the following undead creatures, with higher power levels for powerful parties.

*Skeletons (3-30):* AL N; AC 7; MV 12; HD 1; hp 4; THAC0 19; #AT 1; Dmg 1d6; SD Magic resistance, half damage from edged or piercing weapons; SZ M; ML special; XP 5

*Zombies (3-24):* AL N; AC 8; MV 6; HD 2; hp 8; THAC0 19; #AT 1; Dmg 1d8; SZ M; ML special; XP 65

*Dwarf Banshee (1):* AL NE; AC 0; MV 12; HD 8; hp 30; THAC0 13; #At 3/2 rounds; Dmg 1d2+10; SA Gaxe, malediction, psionic; SD Steel or +1 or better weapon to hit; SZ M; ML 17; XP 2,000

Psionics: Sciences—death field, shadow form; Devotions—Body weaponry, cause decay, chemical stimulation, double pain; Att Modes: nil; Def Modes: IF, MB; Score 15; PSPs 110.



## Part Four: D—The Search (cont.)

**Dune Runner (1):** AL NE; AC 10; MV 18; HD 8; hp 32; THAC0 13; #AT 3/2; Dmg 1d6; SA psionic; SZ M; ML 16; XP 2,000

Psionics: Sciences—mass domination (always on, no cost), mindlink; Devotions—attraction (always on, no cost), contact, life detection (always on, no cost); Att Modes: nil; Def Modes: MB, TW; Score 14; PSPs 100.

**It's big, it's mean.** A large, unpleasant creature decided to lair in the area. Rather than risk messy death at the hands of the creature, or an even messier fate for disturbing Lalali-Puy with trivalities, the templars simply sealed off the offended beast's lair and pretended nothing was there. Select one of the following nasty beasts.

**Braxat (1-2):** AL NE; AC 0; MV 15; HD 10; hp 45; THAC0 11; #AT 1; Dmg 1d6+10; SA Breath Weapon; SD Hit only by magical or steel weapons; SZ H; ML 18; XP 5,000

Psionics: Sciences—psychic crush, tower of iron will; Devotions—mind thrust, psionic blast, intellect fortress, mental barrier, mind blank, thought shield, awe, contact, inflict pain, invincible foes; Att Modes: MT, PB, PsC; DefModes: IF, MB, M-, TS, TW; Score 15; PSPs 80

**Gaj (1-2):** AL NE; AC 2; MV 12; HD 7; hp 32; THAC0 13; #AT 1; Dmg 1d6; SA special; SD special; SZ L; ML 15; XP 2,000

Psionics: Sciences—domination, mass domination, probe, tower of iron will; Devotions—aversion, contact, ego whip, esp, false sensory input, id insinuation, inflict pain, intellect fortress, life detection, mental barrier, mind blank, psionic blast, send thoughts; Att Modes: II, EW, PB; Def Modes: IF, MB, M-, TW; Score 17; PSPs 120

**Tembo (1):** AL CE; AC 4; MV 15; HD 4; hp 20; THAC0 17; #AT 5; Dmg 1d4 (x2)/1d6(x2)/1d8; SA Level drain; SD Dodge missiles; SZ M; ML 20; XP 975

Psionics: Sciences—death field, life draining, shadow form; Devotions—chameleon power, displacement, ectoplasmic form, heightened senses, immovability; Att Modes: Nil; Def Modes: IF, M-; Score 10; PSPs 80

**Short Cut.** For the generous DM. The section is simply a disused area. For the PCs, however, it's a stroke of luck, for it moves them closer to their goal. Skip one or more boxes ahead on the dungeon flow chart, depending on how magnanimous you feel. Just don't make it easy—spring a few false alarms on the party as they move through the dusty, abandoned corridors.

## Part Four: D—The Search (cont.)

**H—Trap.** All the following traps can be detected normally by thieves, but only if they are actively looking for them.

**Pit.** This open pit in the middle of the corridor does not require a detect traps roll to find. It presents more of an obstacle to forward progress than anything else; PCs can avoid it by going back one box on the dungeon flow chart. Otherwise, party members may jump across the pit with a successful d20 roll vs. Dexterity. Failure can have various consequences—2d6 from basic falling damage, and additional damage from spikes and possible poison.

**Scythe.** A spring-loaded obsidian blade snaps out, doing 3d10 points of damage to the first party member who passes. A successful save vs. petrification halves this damage. In addition, there is a percentage chance equal to the amount of damage inflicted that one piece of the PC's armor will be permanently destroyed. Select the armor piece randomly, and adjust the character's AC based on the Piecemeal Armor rules in Chapter 9 of the DARK SUN™ Rules Book.

**Psionic Trap.** A powerful anti-psionic spell has been cast on this portion of the dungeon. Psionics have a flat 20% chance of detecting the bizarre mental vibrations sent out by the spell, giving the party the chance to go back one box on the flow chart. Wild talents may not detect the spell.

If the party does not detect the presence of the spell, then all psionic characters (including wild talents) must save vs. spells at with a -3 penalty, or lose 3d10 PSPs. In addition, for the next 1-4 hours, each character who lost psionic points must make all power checks with a penalty equal to the number of points lost divided by 10, rounded down (i.e., if the PC lost fewer than 10 PSPs, there is no penalty). For example, if a character suffered a 22 PSP loss from the trap, he would suffer a -2 penalty on power checks for 1-4 hours after encountering the trap.

**Spell trap.** A delayed action spell has been placed in the area, and will be set off by the first character to pass by. It will affect the lead character, and as many others as its area of effect allows. Roll 1d6 to determine the spell.

- 1—*Eight-die fireball*
- 2—*Eight-die lightning bolt*
- 3—*Twelve magic missiles*
- 4—*Improved slow (duration 20 rounds)*
- 5—*Ice storm*
- 6—*Chain lightning (12d6 damage)*

**Beast.** As the party passes by, a door opens, releasing one of the beasts listed under *It's big, it's mean* in the *Room* encounter section above. This trap can be found and avoided with a successful detect traps roll, but only if the character is actively searching for traps.

## Part Four: Finale

**Setup.** Play this encounter when the party reaches the space marked “E” on the Dungeon Flow Chart. Have the players look at page 39—The Iron Door.

**Start.** If the alarm has not yet gone out, there are four armored mul guards outside the door. If the alarm has been given, there are 2d4+4.

**Encounter.** The door has been *wizard locked* at 20th level. Once the PCs are in the room, they see Lalali-Puy’s necklace, placed in the center of the room on an elaborate altar. There are also bags and chests, as well as what the PCs will recognize as their own confiscated equipment carelessly tossed in one corner. The PCs can retrieve their equipment and grab as much loot as they can, as stated in the Epilogue.

Should a character approach within 20 feet of the altar, a 15-foot diameter *wall of fire*, centered on the altar, will immediately appear. If the wall is dispelled or moved through, a 10-foot diameter *wall of force* appears, also centered on the altar. These walls are not permanent, but will last 1-6 turns each.

Once the two walls have been activated, Lalali-Puy will be aware of what is happening, and will dispatch her troops to attack the vault in a desperate attempt to save the necklace. One to six turns after the activation of the first wall, guards will begin arriving, 1-4 per turn. These may be either human or mul guards. One to six turns later, templars will begin arriving, 1-2 per turn (see above for statistics). If the party has barricaded the door, the attackers will try to force it with a *chime of opening*. When this happens, have the players turn to page 46, Battle in the Vault.

Have the PCs distribute themselves on the map on page 12, and proceed with the encounter. The enemy will keep coming as long as the encounter goes on, but the DM may have them slack off now and then to give the party a respite.

When the walls are gone, the necklace may be taken and easily destroyed (as it is not yet fully activated, it has no magical protection). If the necklace is smashed or otherwise destroyed, an unearthly scream of rage echoes through the room. This is the cry of Lalali-Puy herself, who takes a personal interest in punishing the PCs.

Once the necklace is destroyed, the Shadow King, true to his word, will attempt to bring the PCs back to his palace. He will succeed eventually, but roll 1d20 several times as if his attempt is running into resistance.

At last, after what you consider a suitable period of suspense, the crowd of guards at the door parts, and the Forest Queen appears, anger and hatred burning in her eyes. She begins to chant and make appropriate hand motions, and the PCs feel the tearing, painful sensation of defiler magic. The DM might even allow her to get off a minor spell or two and badly injure the party before the Shadow King’s teleport “finally” works.

At this point, the PCs are surrounded by a familiar blue glow and, with the Forest Queen’s shriek of rage in their ears, are flung back across the distance to Nibenay.

**Armored muls:** AL N; AC 6; MV 12; HD 1+4; hp 10; THAC0 19; #AT 1;

Dmg 1d6 (maces); SZ M; ML 16; XP 35

**Normal muls:** AL N; AC 10; MV 12; HD 1+4; hp 8; THAC0 19; #AT 1;

Dmg 1d6; SZ M; ML 16; XP 35

**Next.** If the party survived, proceed to the epilogue.

Part Four:  
Finale, Vault Map

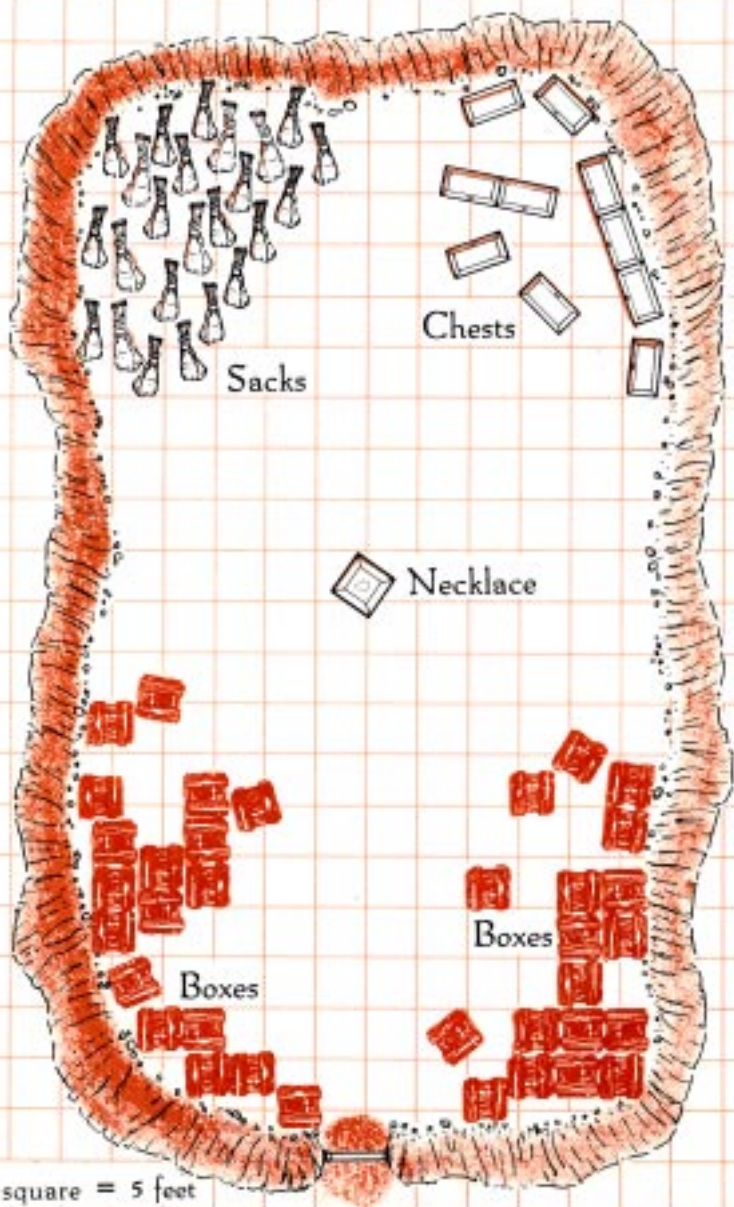

## Epilogue: Back in Nibenay

### **Tying up Loose Ends**

This section serves simply to bring the players up to date, inform them of what they have accomplished, and who they have managed to offend. If the PCs choose to return to Tyr with Semponius, they then meet briefly with Agis of Asticles. In this case, have the players turn to page 47 for a picture and description of the meeting.

### **Friends and Enemies**

If the PCs succeeded in destroying the necklace, Lalali-Puy of Gulg is now their sworn enemy. While it is not good to have a sorcerer-monarch as an enemy, the party can also count the House of Asticles and Tithian of Tyr as friends in exchange for their help in frustrating the Mingons' plots.

As for Mingon, after the truth of her scheme comes out, she and her faction are exposed as traitors and slain or driven out, although no one knows what happened to Mingon herself.

In addition to the gratitude of Agis and Tithian, the PCs have—at least for the moment—the good graces of the Shadow King of Nibenay. Exactly what this is worth is not certain, for sorcerer-monarchs are almost as dangerous when they are friends as when they are enemies.

If the party failed to destroy the necklace, they are now the enemies of both the Shadow King and the Forest Queen. With her magical powers enhanced by the necklace, Lalali-Puy will have a distinct advantage in the struggle against Nibenay. Exactly what this means for the future of the conflict is up to the DM.

Should Semponius of Asticles be dead, reaction from Tyr will vary according to the PCs involvement. If they made every effort to save him, and acted bravely, Agis will forgive them and still be positively inclined toward them. If, on the other hand, the party did little or nothing to help him, or—worse yet—if the Shadow King kills Semponius and then frames the party, they will also be enemies of the House of Asticles, thoroughly reviled in three city-states, and in dire peril. While this will not make the players terribly happy, it will provide limitless opportunities for future adventure as the characters try to clear their names.

### **Treasure and Experience**

Characters should receive experience based on the number of foes defeated, as well as for good role-playing and individual accomplishment. A bonus of 1,000-4,000 xp should be given if the party succeeds both in bringing Semponius back to Tyr and in destroying Lalali-Puy's necklace.

If the party wished to bring any of the items found in the treasure vault back with them, use the following guidelines. Chests contain 1d6x1,000 sp, while bags contain 5d6x100 sp. As on Athas, some equipment is worth far more than money, there is a 25% chance that each sack or chest will contain a useful item such as a box of spell components, metal weapon, or a small amount of gold (1d6x100gp maximum). In addition, there is a 10% chance that each sack or chest contains a randomly-generated magical item.



# Boneyard Lights

by Allen Varney  
and  
Aaron Allston

For a second night the hunters sought the fugitive. On the first night, prisoners' cries had echoed through the Crescent Forest as, one by one, they fell to the Red Moon hunters. Smiling warriors emerged from the woods bearing the heads of their victims and accepted the praise of their fellows. With the dawn, at the Sunlight Palace, they gained greater rewards: titles of nobility, gifts of the sorcerer-queen herself.

Yet one prisoner escaped every hunter. When morning came, the unlucky searchers—those who had not claimed a head—camped and waited sullenly. They expected him to stumble out of the woods at any moment, tired but triumphant, to claim his freedom. But as the hours passed, they decided he must have died, fallen prey to some colleague who hunted on four feet instead of two.

Then the thin and nervous boy who served as mind-messenger caught a sending. The hunters fell deathly silent as the child's eyes rolled back, his bone-thin limbs shook, and he spoke in sharp tones. "A court storyteller, old and lame, and you cannot find him!" came the queen's scornful words. "But We are generous. The prisoner has not claimed his freedom, and so We declare it void. You who failed have a second night to avoid shame."

The hunters muttered among themselves. Two Red Moon Nights! Unprecedented! Yet none spoke above a whisper for fear of angering Lalali-Puy. She was cruel as the sandstorms that swept across the Athasian tablelands. The fugitive himself, now condemned to death not once but twice, had merely made one thoughtless jest about her new sunbird-plume headdress.

So they held to their camp, and when darkness fell they moved out again. They crossed and recrossed the pathless forest north of Gulg's Mopti Wall. Increasingly desperate, they ventured farther north, risking the vicious night patrols from Nibenay. They traveled in shadows, moving so quietly they could not hear each other. Still the old man, or his body, eluded them.

Until, at last, Bareel found the trail.

Page 1 . . . . .	<i>Boneyard Lights</i>
Fiction by Allen Varney and Aaron Allston	
Page 12 . . . . .	Sitak
Page 13 . . . . .	<i>Astilican Gambit</i> Nonplayer Characters
Page 13 . . . . .	Habban-Puy
Page 14 . . . . .	Mogadisho
Page 15 . . . . .	Shala
Page 16 . . . . .	Taibela

This material is protected under the copyright laws of the United States of America. Any unauthorized use of the material or artwork contained herein is expressly prohibited without the written consent of TSR, Inc. Copyright ©1992 TSR, Inc. All rights reserved. Printed in the U.S.A.  
Random House and its affiliate companies have worldwide distribution rights in the book trade for English language products of TSR, Inc.  
Distributed to the book and hobby trade in the United Kingdom by TSR Ltd.  
Distributed to the toy and hobby trade by regional distributors.

ADVANCED DUNGEONS & DRAGONS is a registered trademark owned by TSR, Inc. DARK SUN and the TSR logo are trademarks owned by TSR, Inc.

All TSR characters, character names, and the distinctive likenesses thereof are trademarks owned by TSR, Inc.



## Boneyard Lights

\* \* \*

Urgati, the moon that outlanders called Ral, rose high. Its orange light dappled the ground like the coat of Kheera the jaguar. Enormous cashew and silk-cotton trees, festooned with ferns and lianas and red orchids, stood all about like decorated guardsmen. Far away, a touraco screamed in fright and beat its way into the sky.

Bareel waited in a patch of darkness. He stood tall and straight as the hunter's spear he held, and his features were hard and merciless as the angles of the spear head. The kilt he wore was not bright and cheery after Gulg's fashion, but a mottled forest brown, invisible to prey as he stalked the woods. His build-lean and graceful, with muscles suited for combat and not for show -made women think of a panther. His eyes, too, gleamed like those of a great cat . . . just before a kill. They passed over the night's beauty and sought only prey.

The winds, like courtiers offering tribute, brought Bareel the scents of the forest: the watery smell of toadstools, sharp and delicate scents from loose tufts of cord moss, a predator's kill, acrid vapors near an orange rash of tree mold. The hunter paused to rub his fingers in the mold, then smear its moisture on his arms. The smell helped fend off gnats.

Moving in a careful silence, Bareel passed near a gigantic pink blossom, wider than his height and rank with the odor of carrion. Bareel smiled to see the stinkflower. It lured scavenger insects with its scent and then drowned them in the water trap within its petals. Hunters took it as a good omen.

He saw no sign of his quarry. But Bareel knew he was out there, not far.

The others were stupid. They sought an old man who fled blindly, smashing his way through underbrush, leaving strips of his prison tunic on every thorn-bush and protruding twig. And they found nothing, because that man did not exist.

Bareel sought a different prey. True, the fugitive was old, and only a court storyteller. But in his youth he must have been a fine hunter. Bareel stalked him as he would a peer.

He crept along the banks of creeks, seeing where the prey might have taken to the water to throw off pursuers. He looked for a stump where a branch had been hacked off to make a staff, for signs that small game had been brought down by crude weapons instead of predator teeth. He moved in a back-and-forth pattern that took him gradually toward the distant town of Nibenay—for if the old man wanted to live, he would need ultimately to live among people again.

And Bareel found the signs he sought. By his reckoning, the old man had entered the first stream he'd found, emerged from it half an hour's walk downstream, and then headed deeper into the woods, making himself a stout staff at his first opportunity. But smart or not, he was still an old man. That, and the efforts he took to throw off pursuit, meant he was moving very slowly.

The hunter had to be nearing his prey. He bared his teeth in a smile. He would chide the others for misjudging the old man, and they would know him for their better.

He heard a cry, sudden and loud, and he froze. But at once he recognized the "Caw!" of greeting. The sitak glided out of the darkness to land on his leather shoulder pad. The white bird, parrot-beaked and crested with spiky feathers, peered at Bareel's hair, hopefully seeking a choice beetle or grub. Its thought glided smoothly into Bareel's mind: *Food?*

The hunter moved forward, keeping to darkness, alert for his prey. *You get no food yet. Find the thoughts of the man.*

The bird sulked. *No man-prey here. No mouse here. No snake. Go far, find food?*

Bareel ignored it. He prized the sitak, for it let him communicate with an ally without alerting others





nearby. But it was a selfish and ravenous little beast. He had never named it.

Something in the bird's message pecked at him. *Wait. No mouse here? No snake?*

*No food. Go food now?*

The hunter looked around. Nothing seemed unhealthy about this patch of forest. Nothing except fire would drive away all the animals. Fire, or-?

It took Bareel a moment to phrase another question, for the sitak could not follow complex thoughts. *Where is there much food?*

The sitak turned its crested head halfway around, staring back toward Gulg.

*And where is the worst place to find food?*

The bird looked ahead and to the left. Bareel moved in that direction. The sitak squawked in anger, so Bareel gave it a swat to shut it up. The bird flapped up onto a branch overhead, silently scolding him.

A dozen steps farther on, Bareel found a gouge in the earth. It took him another moment to find a tree-root bruised where it protruded above the ground. The old man was walking on the tree-roots so he wouldn't leave footprints in the forest loam. He had slipped and used his crude staff to keep from falling. Bareel's teeth showed in a predatory grin. Silently he continued forward. More marks—the old man was getting tired and making mistakes.

Intent on the trail of his prey, Bareel only gradually realized that all the trees around him were dead.

Swiftly he backtracked, moved by sudden terror. He found no sharp border, but fifty paces back the trees looked unhealthy. Farther on they bent like sickly men. Where he had just stood, they were hollow, blackened shells, stark against the moonlit sky. Nothing grew on their twisted limbs, and no fungus ate at the peeling bark. The gnats had long since vanished.

Fear clutched Bareel. He struggled to control his shaky breathing. *Weakling!* he thought. *You tremble like a young girl!* But he knew that this was dark magic. He had no way to fight whatever blighted this

place. No way, except. . . .

He fingered the patch of black fur hanging from his beaded belt. At the touch, he heard in his mind the distant roar of a panther.

No. What he *did* have, he could not risk using. Where the old man had gone, Bareel dared not follow.

He turned back toward Gulg. But he could not move.

Indecision gripped him like Hiassi, the python. The old man's head meant a title of nobility. Bareel thought of his father, Onra, sweating on a dirty cot as illness stole his strength and life. As a noble, Bareel could bring in healers to cure Onra. He thought of his father's quick barking laugh, his incisive mind, his great gift for teaching even the dullest hunters, as he had taught Bareel.

"Think with your prey's mind," his father often said. "See with its eyes. But never, never feel with its heart. Do not pity your prey, nor fear what it fears. We, the hunters, must kill fear as we kill the prey."

Bareel started forward again, leaving Gulg behind. He would not let cowardice condemn his father to death! But as he walked on, cold sweat filmed his dusky skin.

A light flickered far before him, and he felt a brief warmth of triumph. The fugitive's camp! But that made no sense—if the canny old man could evade Gulg's best hunters, he would not foolishly build a campfire in the middle of the forest. Bareel gripped his spear and walked on in silence.

Past a screen of skeletal trees, he found a lighted clearing. And Bareel knew why no one had found the old man.

Here stood the Bone Village.

\* \* \*

Angry mothers used it to frighten ill-behaved children. "We will take you there and you will never come



## Boneyard Lights

back," they said, and the children's eyes grew round.

Then the children grew up and learned the tale was true. As old as Gulg, the Bone Village was indeed a place of punishment. Ancient druids once brought enemies of the forest here and killed them. Now Lalali-Puy carried on the tradition with her own most hated enemies.

The spirits of those who died here could not leave while their bones remained. Trapped in undeath, they would never be reborn to harm the forest in another life. Mad animals, that killed wantonly from the rage of injury or disease, were destroyed here for the same reason.

Here stood the Bone Village, stark and lifeless. In this huge clearing, white bones were assembled in cairns, tombs, and sarcophagi. Skulls like eggshells and like boulders, a serrated skyline of ribcages, weathered mastodon tusks, jawbones big as a doorway, teeth and fangs thick on the ground like pebbles—the bones of millennia, of a hundred king's ages, lay in piles or were strewn at random.

Lights danced above the clearing—pale balls of light that drifted like butterflies, resting on the bone piles, flitting from tower to pedestal to upthrust rib. Yet they never passed beyond the clearing's edge.

Bareel knew them: the trapped spirits of the men and beasts who had died here. The stories had described them this way, and now he believed. Until their bones could be buried intact beyond the Bone Village, they would be eternal prisoners. But he was surprised to count only a dozen. If the stories were true, hundreds of spirits should flicker here.

He did not intend to join them. Quietly, so the spirits would not notice, he backed a few paces away. Only then did he breathe again. He would circle the Bone Village as the old man must have done, pick up the trail of his prey on the other side. . . .

Then he heard a croaking whisper that formed no words Bareel could understand. The skin prickled on the back of his neck. The speech of ghosts?

No—he began to make out a few words: ". . . placed his back against the wall . . . forth Tarahar, the shining blade . . . men of the horde came . . ."

The Epic of Cathdar. All men and women of Gulg had heard the story of the hero and the sword Tarahar, who slew a hundred warriors of Nibenay, but perished on their spears. This was no ghost speaking—the storyteller was here! Yet though Bareel moved all the way around the Bone Village's boundary, he could not see the man he sought.

Come now, he told the sitak.

A thought flew in from the darkness. *Food now? Come now. Find man-prey.*

Irritated, the bird fluttered in, veering away from the Bone Village. But Bareel ordered it over the clearing before it settled again on his shoulder.

*Man in hole*, the bird said, preening itself. By *big-many bones*.

The sitak meant the largest heap of bones at the clearing's center. Bareel sighed. He edged into the clearing, moving silently, hoping the flitting ghost-lights would not notice him.

Pale greenish-yellow light flicked across the ground in wavering aurora bands. Dry marrow scented the still air. He circled intrusive mounds of remains, many of them tied together to resemble statues, miniature citadels, or trees. Not one of the bones showed a predator's teeth marks. It unnerved him.

As he neared the pit, the old man's speech became clear.

". . . The ninety-ninth fell numb and nerveless  
As our soldier's sword split his scale.  
He said, 'My skill with sword and spear  
Has laid the lives of lordly legions,  
But Cathdar, king of courage and craft,  
Has braved the battle, battered and beat me.'"

Cathdar's saga was nearing its end. The great hero of Gulg would taunt the last of Nibenay's warriors,



then they would die on one another's weapons. Yet the old man did not continue. "Nay, give me a rest. My throat fails me," he said. His voice rasped like saw-teeth on wood.

Bareel heard the answer—an insectile rustling, like no human or animal sound. His skin tingled and his hands shook. He had to force himself onward.

It took him long minutes, creeping with a cat's stealth, to cross the last twenty feet of bony ground. Finally, beneath the yellow-white tower of bones, he could look down into the pit. When he saw the decaying brick walls and smelled the stale water pooled below, he knew the place.

The Ghost Trap. Here, in the heart of the Bone Village, Lalali-Puy had turned this place's magic to her own ends. In this half-buried chamber she held the spirits of those sad victims she had tortured beyond death.

And here lay Fanzior the storyteller, propped against a brick wall, his face contorted in exhaustion. His long white beard, no longer neatly trimmed, was sodden with mud and twigs. Cuts on his arms, legs, and face looked black in the moonlight . . . and in the light of his audience.

Bareel nearly bolted and ran when he saw the listeners. Not human, nor animal, nor insectile—not alive—the glowing hosts of the Bone Village's trapped spirits, hundreds of them, clustered together in an ever-shifting mass. Pale white, whitish-blue, a sickly green: Each spirit shone a slightly different hue, for they looked as distinct as the bodies they once inhabited. But all glowed bright and menacing as a candle-flame toppling into a straw floor.

Then he saw a murder.

Deep in the glow he saw the stoop-shouldered Raamian assassin creep up behind his victim and strike with a glinting obsidian blade. The image dissolved. Now a radiant mother held her wrinkled newborn for the first time, then faded to a pastel blur. A nut-brown boy ran through the streets of a village, past

granaries and mud-thatch homes . . . a warrior in red, spear outthrust, leapt from the low branches of an almendro . . . lovers wandered together in the shroudlike shadows of Gulg's thorn wall. Each vision passed like sand in the wind.

Bareel finally tore his gaze away from the mesmerizing lights and the stories they told. Fanzior was as good as dead. Tale-tellers said that these spirits had gone mad from boredom and undeath, and their touch caused freezing pain. One spirit was not dangerous . . . alone. But below floated an army. If Bareel took away their toy, the spirits would swarm over him, biting away his warmth and his life. Dying here in the Bone Village, with no one to bury his remains in proper fashion, he would join them for eternity. He must return to Gulg, leaving Fanzior to die.

Then, once home, he could watch his father die.

Bareel shut his eyes. *Do not pity your prey, nor fear what it fears. We must kill fear. . . .*

He tried to think it through as Onra would. He faced two obstacles before he could pull Fanzior out of the pit. First, Fanzior would not cooperate with a Red Moon hunter waiting to kill him. So Bareel had to take on another trade to trick the old man.

Next, the spirits. He had to lull them, or persuade or frighten them, into letting the old man escape.

*Frighten. . . .* Again Bareel fingered the patch of panther fur hanging from his belt. He turned his thoughts away from the panther fetish . . . but no better idea came to him.

*Talk to the man,* he told the sitak. *Say the words I say.* Again he looked down at Fanzior. The storyteller sprawled across one of the pit's black pools of water, greedily scooping water into his mouth. The spirit-lights slowly edged toward him, moving more and more restlessly. *Old man, can you hear me?*

Fanzior spat out his last draught and looked wildly around.

*No, don't stir them! I'm speaking to you from outside the pit, through my sitak.*



## Boneyard Lights

Fanzior shrank away from the spirit-lights before him. *Who art thou?* His was the lofty High Speech of Lalali-Puy's court. Bareel would have to practice it, once he gave the old man's head to the queen and received his grant of nobility.

Bareel knew that gaining the man's trust would take time. *I am Askagel, a hermit. Walking through the forest, I heard you recite—*

*Never mind all that. Get me out of here!*

Bareel stumbled. *—uh, the Epic of Cathdar. My heart went out to you when I realized—*

Fanzior's thought came as a shout. *Silence, halfwit! Take me safely from this ghastly hole, and I vow I will listen to thy tedious story until the moons shatter!*

Bareel paused. *Umm—if you insist. But why do the spirits hold you here? I must know what they want if I am to deal with them.*

The old man's tone fell back into despair. *I came here fleeing . . . well, an animal. Fear burned through me like the poison of the serpent's fang, yet even in my crisis I conceived a wild scheme to achieve safety. I knew my pursuer would be too frail of heart to follow me into the dreadful Bone Village. All seemed well, until, misled by a vagrant light, I fell in this noisome pit. The spirits swarmed upon me to steal my life away.*

The old man took another swallow of water and continued. *I begged them to cease, and promised them stories such as they had never heard—for I am by trade a storyteller. And oh, how they have listened. For a night and a day and a night they have lapped up my tales like a starving cat drinking fine erdlu milk from a carved punchbowl of polished mahogany. But I am so tired! My voice is a ruin, my stories are all used and gone. I have only muddy water to drink, and my stomach cries for meat and bread. I do not want to die here, hermit, and join these dismal ghouls in their eternity of boredom and hatred!*

Bareel sent back the thought: *I swear you will not, storyteller.* He did not send the private thought: *At*

*least, not until you are in my hands.*

Bareel knew what to do. He sent: *Finish Cathdar's tale; keep the spirits from your throat. Give me time, and I will save you.* His words were confident, but he felt icy fear as he looked down at his panther fetish.

\* \* \*

Hangati, the second moon, passed overhead like a funeral ship sailing across a sea of black dust. Bareel was glad for the extra light. It helped him distinguish between human bones and the ones he wanted.

Fanzior croaked on, taking long-dead Cathdar through his boasting-match with the hundredth Nibeni, to the bloody exchange of spear- and sword-blows that would end both lives. Bareel strained to hear as the old man's voice faded. He chanted his own words as he worked, making it harder to track Fanzior's progress.

Then the ghosts in the pit chattered, and the sitak relayed Fanzior's words: *I have done with Cathdar's tales, and the spirits will take me now!*

*Tell them another story, old man. I need more time.*

Fanzior's thought was frantic. *I have no more tales. They have stolen all my stories! Do not let me die here, to be trapped as a ghost in loneliness forever!*

So strong was the despair in Fanzior's plea that it almost shook Bareel from his meditation. *Then make up a tale, storyteller. Tell them of—of the great hunter, Onra, who hunted a monster but found a wife.*

"Wait!" Amid the echoing gabble of the ghosts, desperation strengthened Fanzior's voice. "Be of good cheer, immaterial friends, and hear a tale told by my grandfather's grandfather, which brought a smile even to the stern visage of Lalali-Puy—the tale of Onra, greatest hunter of a dozen generations, and the monster which led him to beauty." The chattering quieted at once. In the expectant silence, Bareel heard the old man's frantic thought: *What comes next, hermit?*



Bareel moved among the bonepiles seeking a shoulder bone. *An id fiend was killing people in Gulg and in the forest.*

"It befell in the Year of Enemy's Fury, the time of ill omen for peaceable villages, that a fearsome id fiend, that lizard that brings forth the bravest fighter's deepest fears, rolled upon Gulg like a sandstorm. The king of its kind, it slew right and slaughtered left, feasting on blood, mocking the strength of the city's warriors. . . .

The story continued. While the hunter Onra, mourning his slain friend Barakur, forged deeper into the forest in search of the lizard-thing, Bareel completed his own search. Here was the shoulder bone he needed; there, the lower jaw; and from one misshapen column of a bone temple he pried the last thigh bone.

When he had all the bones, he unravelled thread from his kilt and began laboriously tying the bones together. He looked at the fetish with mingled wonder and dread. The patch of fur looked sharper, more real than the bones all around. With each word he chanted, every bone he added, the moonlit clearing grew pale and the panther fur blacker and more lustrous. Bareel's own earth-brown skin looked vague and indistinct beside the fetish. He shuddered.

Time to pass along his next cue. *The fiend guarded a servant woman, Hara, who was lost in the forest.*

"The greatest gem of the fear-lizard's glittering treasure hoard was the Princess Hara, whose spectacular beauty enfeebled the most fulsome blandishments of poem and song—whose suitors, rather than settle for mortal flaw, had wandered heartbroken into the stony wastes when she would not have them—"

The moons sailed across the sky. Bone by bone, Bareel threaded the skeleton together. He whispered ancient words over every knot.

*He fought the id fiend and wounded it in the foreleg with his spear. It ran off Onra and Hara fell in love. And they were still in love. Without Hara's tender*

caring, Onra's fever would have sweated away his life by now.

A terrible curse, the wasting sickness. Borne by bad air or spoiled food, it struck the forest villages in each year's season of high sun. The skin flaked and pulled tight, eyes gazed dully from hollow sockets, the tongue swelled, and a thick sugary odor filled the sickroom as the illness broke down the body's organs. Yet Lalali-Puy's templars could cure all with a pass of their hands, if the victim came of noble family.

Would Onra still live when Bareel returned to Gulg? The hunter hurried with his knots.

"The most puissant hero of Gulg faced the ferocious king of the id fiends, and they stared at one another with ancient understanding, knowing that only one of them would leave this place alive, that the fiend's cave would soon be a grave. . . ."

In time, skeleton and story were both done. Though crude, the construct looked powerful, with bunching shoulders, sharp teeth, and wicked claws unconcealed by flesh or fur. And the great Onra had speared the fiend and was exchanging tokens of love with the Princess Hara.

Bareel sent, *Keep talking. I need a minute or two more.*

*I have more to tell, O hermit.* The old man's voice rang surprisingly strong after all this time. Hope must have revived him. "Onra lived on as Champion of Gulg, and the Princess Hara brought beauty and grace to the court of the city. In the lengthening years she bore him a son, night-walking Askagel, silent as a forest spirit, rescuer of strangers, friend of animals . . ." *Quick, boy, describe thyself.*

Startled, Bareel looked at the pit. The old man showed the cleverness of Onra himself. And in only minutes he would die at Bareel's hand. Bareel stared up into the moonlight and tried to reply. There was a tightness in his throat, and he was grateful he need not speak aloud. *I could not make myself as fine or noble as you will, storyteller. Make me up. Then you*



## Boneyard Lights

will not be unhappy with the result.

"A fine son, tall and straight of limb, blessed with keen eyes and a graceful walk. . . ."

Bareel stroked the panther fetish, recalling the time he'd made it, years ago now. That time of pain and rebirth, the ancient rite of passage from boyhood to manhood: He remembered the day not long after his voice broke, when the village chief chased him between twin rows of villagers. At every step they beat his naked back with stinging vines. Their chant: "Not boy, not man, leave our home." The last and hardest blow raised tears for many reasons, for the vine belonged to Onra. And then the boy fled into the forest.

Three hungry days. By law he cannot eat. He finds puddles, but their water cramps his stomach. Fear growing in him like the creeper, haze in his eyes, he seeks help, seeks understanding. He moves light-headed along the game trails. The spirit of Panther pounces. How the boy's heart beats! Hot blood-scented air in his face, slitted pupils, a measuring look. *You will do. Hear the words of summoning.* He repeats them. Panther nods and vanishes into the brush.

He staggers back to the village. Onra greets him with tears in his eyes. His parents present him to the chieftain, saying, "A man from another place seeks a home here." The chieftain nods as Panther nodded. Everyone cheers. At the feast he sits on the chieftain's right. And in his dreams that night he sees the crouching black shape, hears again the words. . . .

He was repeating them now, his heart pounding as before. The realization startled him out of his memory. Words came to Bareel's lips unbidden, and his breath stank like the bloody breath of the Panther spirit. In a fresh sweat, he bent to complete his task.

With his last thread he tied the patch of panther skin onto the ribcage of the skeleton. As he stepped back, the fetish fluttered in a wind Bareel could not feel. It bobbed in a slow rhythm, like a heartbeat.

Whatever spoke inside Bareel stopped. He felt something pass from his body. Seconds crawled by.

Like a housecat stirring from sleep, the skeleton stretched.

A round it, Bareel dimly perceived the muscled fur of the panther. The Bone Village's light gleamed at its edges like black glass. Bareel's sitak shrieked and flew away into the trees.

The panther-thing sat halfway up and looked sleepily at Bareel—a just-awakened king blinking tolerantly at an intrusive courtier. Its words echoed in Bareel's mind, speech different from, far deeper than, those thoughts the sitak relayed: "It is the little lost hunter-boy. I hope thou hast brought me here to feed, Bareel Onra's son."

"No." Bareel pointed to the pit. "To chase, but not to feed. There are spirits there, and one old man. You must chase the spirits away . . . but do not touch the man in the pit."

The panther-thing snarled, and the deep tones of its growl rattled bones on nearby piles. "I do what I do, hunter-boy. I will taste flesh ere I go. Whose will it be?"

"Not that of the old man in the pit. You are bound by a compact older even than you. I command; you must obey. Now go." Bareel felt like a slave commanding a king, but he hid his fear. He gestured again at the pit.

The panther growled again and launched itself—a heart-stopping instant—into the pit. It landed with a clatter of bone on brick, and Bareel could feel its roar in his teeth. Fanzior cried out. Ghost-spirits erupted like birds from the pit, spinning and fleeing across the clearing, then winking out of existence at its edge.

Bareel ran to the pit's edge. Fanzior pressed himself into the shadows against the brick wall, away from the panther spirit. The roaring skeleton flailed at the glowing cloud, a cat pawing at smoke. And the smoke screamed.

"Old man!" Bareel called, and Fanzior looked up at



Bareel's extended hand. "Jump. We have little time."

"I fear I have bad news for thee then, hermit." Groaning, Fanzior clambered to his feet—to one foot. The other leg hung at an angle the hunter knew was wrong. The old man could never jump high enough to reach his hand. Bareel cursed, debated, and dropped into the pit.

He landed badly, slipping on a patch of water, and felt pain shoot through his knee. A mere spear-length away, the panther spirit swung its paws to trap a ghost-light, biting it as a cat would bite the neck of a erdlu. The light screamed in a very human voice and then vanished.

"The panther broke your leg?"

"Nay, when I fell yesterday-I did not want to tell thee, lest thou—"

"Not now!" Bareel got one hand on Fanzior's arm, the other on his good leg, and heaved him to the pit's edge. But now the panther crept toward him, bones rattling, with a growl that echoed in the pit. "No!" Bareel screamed. "Back! I order you!" His voice sounded shrill and powerless. The skeleton drew closer as Bareel fought against panic. *Kill fear as we kill our prey—*

Without warning the panther veered away and resumed its attacks on the ghost lights. Letting out his breath, Bareel shoved until the storyteller, screaming in agony, struggled out of the pit. Bareel's strong leap took him to the top of the wall, and he scrambled onto solid ground.

Fanzior gasped. "Young man, thou hast my undying thanks. For all the years I have remaining, thou mayest come to me and ask anything; I will grant it. I owe thee my life."

Bareel felt sick. "I . . . cannot accept your thanks or your favor. My duty compelled me to save you."

"Thy modesty becomes thee." They glanced into the Ghost Trap. The panther still ran from side to side, trapping and extinguishing the last of the fleeing spirits. As the lights faded, darkness descended on

the Bone Village.

"If I am to leave this place without stumbling o'er every bone," Fanzior declared, "I will need light. Happily, I have a power of the mind to help us. Quickly, find a branch, if you can, or my staff where I dropped it." He turned to look through a pile of bones.

His heart heavy, Bareel recovered his spear and moved toward Fanzior. The old man would never see the blow.

Fanzior came up with a dry piece of wood and stared at it. After a long moment the stub-end smoldered. Surprised, Bareel paused to watch the old man's mind-talent in action. Another few seconds and the wood burst into flame. "A shame I had nothing to burn down there," Fanzior said, turning to face Bareel. For the first time Bareel saw the old man clearly.

Despite his broken leg, Fanzior stood tall and straight as a spear. Though lined, his features looked hard and strong. Shrunken with age and exertion, his frame was still large, with good muscle still on it. His eyes, dark and thoughtful, gazed alertly like those of a forest cat.

Bareel stopped, gazing in wonder at a man who could be his father's brother—who could be himself in forty years. Thirty!

One step, one thrust, and nobility would be his. The best healers of Gulg would come to see Onra.

Bareel could not take that step.

The last light disappeared from the pit. Bareel could not see the panther spirit in the blackness. Hope flamed like firelight in Bareel's heart. Could it have returned to its—?

The skeleton sprang gracefully to the pit's edge, landing between Bareel and Fanzior. Fanzior, with a hoarse cry of alarm, tried to step back . . . but his bad leg gave way, and he fell hard on a pile of bones.

The panther-thing growled silently in Bareel's mind. "All the footling smoke-wisps are gone. They



## Boneyard Lights

will not return for some time. The old man is out of the pit. I have done all thou hast commanded, Onra's son.

Bareel nodded. "Then you are free to go."

The skeleton coughed and Bareel heard laughter. "No, little hunter-boy, I am free to act. I taste flesh ere night is done." Its lifeless eye sockets gazed on the hunter, and Bareel tensed. But the skull turned to Fanzior. "A hunter takes the straggler of the pack. His flesh will do."

Bareel brought his spear up. His silent challenge: "No. He is mine."

The panther stared again, and a reply stole into Bareel's mind. "Hunter, we are one. Thy thoughts hide not from me. Thou needest only his head. I will leave that. Be glad that I share this kill." And it leaped on the storyteller.

Fanzior shrieked. His torch, struck from his hand, landed yards away. In its orange light the panther-thing loomed over him, its hollow shadow dancing across the bone towers.

Bareel stood transfixed. A moment's wait, and the sated panther-spirit would return where it belonged. Bareel could take the proof of his victory back to Lalali-Puy. A moment's wait.

*Never, never feel with your prey's heart. . . .*

Bareel threw himself on the panther's back, crashing onto the bones he himself had woven together. A pain both hot and cold burned his thighs and arms. His spear drove straight through the skeleton, harmlessly.

The panther-thing roared and arched, nearly throwing the hunter off. The spear went flying. Bareel hung on with a strength he had never known before. "You and I are one," he said, or tried to say. "I have your strength!" Yet the words felt false and hollow.

The skeleton thrashed and rolled, crashing into a dome of bones. Broken shards jabbed into Bareel's back as the dome collapsed. The thing was so strong -one more wrench and it would surely throw

Bareel free—

"Ayahh! Turn, foul feline, and face your conqueror!" The panther's hindquarters jerked as Fanzior pulled at the long string of tail vertebrae. But he did not have the spirit bond, as Bareel did. The old man jerked his burned hands back with a cry, and the panther turned with a roar. Still, the distraction gave Bareel a second to regain his hold.

In panic Bareel saw the broad paw rise, glint darkly in the moonlight, and fall. Fanzior screamed again. Bareel sought madly for some weapon, anything. . . .

Through the ribcage Bareel saw the panther fetish, still fluttering in rapid rhythm. He jammed his hand through the ribs and grabbed for it.

Abruptly he was upright again as the panther-thing reared backwards. His seeking hand fell on the patch of fur and he yanked it free. The skeleton roared a final time and flew to pieces. Amid a shower of bones, Bareel fell into the Ghost Trap.

\* \* \*

### *Food?*

Bareel opened one eye. He saw moonlit sky, framed by the four brick walls of the pit. The sitak perched on his chest, rising and falling with his breath. His back hurt—no, his back hurt *worst*. Everything hurt. Cautiously he rose, hoping nothing was broken. No *food*. *Food soon*. Every movement brought pain.

It was harder getting out of the pit the second time. Urgati and Hangati had fallen almost to the horizon. Bareel called, "Fanzior?"

"Here." The old man still lay where he'd fallen; his torch still guttered, out of reach. "I am glad thou art alive."

"And I, you." Bareel approached the storyteller, now heedless of the bones crunching beneath his feet.

"I did not say my name, hermit-or, shall I say, hunter. Not thy first mistake, I would say. I have known many hunters and their ways. Wilt thou kill me





now?"

"Not now." Bareel sighed. "Not ever. Though it cost me my own father's life, I cannot murder you."

The old man's chuckle was like a moist cough. "Then thou art no Red Moon hunter."

I came here a hunter. Now I am a betrayer. What am I to this world, that I must draw lots for two lives?" He tried to guess his future and found it blank, dark. "I suppose I will have to learn."

"That is not quite a good ending." Fanzior sounded sleepy. "Not like a tale I would tell. I fear I must give thee a better one. How nice to be part of one last story." He breathed out one more time. Bareel knew that rattle.

He brought the torch near Fanzior. The storyteller's eyes were still open, and torchlight showed the bloody tracks of panther-claws across his dirty tunic. His life's blood pooled beside him, black in the torchlight.

Then a new light flickered into life, a pastel-silver globe mere feet above the storyteller's head—another spirit trapped in the Bone Village.

Bareel stared. In it he saw the images of the spirit's life: tales of heroes and adventures spun to charm children, tales of import and precedent intoned before the court of Gulg. He watched in silence, and at last he saw himself, spear in hand, staring at Fanzior's burning torch. The light drifted to him. Near it he suddenly knew terror, a fear not his own but the spirit's. He hid his face in his hands and wept.

He was surprised that he resisted his next thought.

True, he might bury the body outside the Bone Village . . . without the head. The tales said this would not lay the spirit to rest; the body must be whole.

He knew nothing about it, but perhaps the tales were wrong. He needed the head. Why not take it? After all, as a hunter he had trifled with life and death for years.

Again he felt sick. He told the light, "No, old man. You will not be imprisoned here, in loneliness forever.

\* \* \*

Far outside the circle of dying trees, Bareel spoke a ceremonial eulogy by torchlight. The panther's skull, set atop the storyteller's staff, marked the grave.

Then he said his own farewell. "I suppose I am still a hunter, old man. But now I hunt a new way to heal my father . . . and me, I suppose. I hope you wish me well, wherever you go."

Carrying nothing but his spear and Fanzior's torch, he turned toward Gulg, already rehearsing the story of his failure to locate the prisoner. *Well, at least we will get food*, he thought to the sitak. The bird cawed in triumph.

Behind them, the last light over the Bone Village rose high, past the ancient barriers, and vanished in the dawn.

<b>CLIMATE/TERRAIN:</b>	Athasian forest
<b>FREQUENCY:</b>	Very rare
<b>ORGANIZATION:</b>	Flock
<b>ACTIVITY CYCLE:</b>	Usually night
<b>DIET:</b>	Omnivore (insects, fruit)
<b>INTELLIGENCE:</b>	Animal (see below)
<b>TREASURE:</b>	Nil
<b>ALIGNMENT:</b>	Neutral
<b>NO. APPEARING:</b>	1-12
<b>ARMOR CLASS:</b>	8
<b>MOVEMENT:</b>	2, Fl 18 (C)
<b>HIT DICE:</b>	1-3 hp
<b>THACO:</b>	20
<b>NO. OF ATTACKS:</b>	2
<b>DAMAGE/ATTACK:</b>	1 hp
<b>SPECIAL ATTACKS:</b>	Nil
<b>SPECIAL DEFENSES:</b>	Nil
<b>MAGIC RESISTANCE:</b>	Nil
<b>SIZE:</b>	T (1')
<b>MORALE:</b>	Unreliable (2-4) (see below)
<b>XP VALUE:</b>	15
<b>PSIONICS:</b>	Contact, mindlink (20), 5 PSPs

The sitak is a forest bird of Athas. Its bears a close relation to the parrot and cockatoo (both of which also exist on Athas), evident in its sharp, curved beak, wicked talons, and bright feathers, as well as its gift for mimicry. However, the sitak imitates sounds telepathically, not audibly.

Sitak coloring varies across the spectrum. Many are bright green or red with yellow throats, but light blue, gray, white, and black varieties are almost as common. Feathers grow in a spiky crest atop the head, and observers may mistake a white sitak for a cockatoo until it begins chattering psionically.

The sitak has the psionic abilities of contact and mindlink, though in a unique and limited form. It pays no PSP cost for using its abilities—but they work line-of-sight only, and the sitak has poor vision beyond 30'. Any resistance by the target automatically breaks contact, and the bird cannot contact life forms lower than birds. Also, the sitak's mindlink does not cross language barriers, because it is simply mimicking sounds it does not understand. (However, see below.)

**Combat:** Sitaks frighten easily and seldom attack unless cornered. The sitak strikes first with its talons, then its beak, doing 1 hp damage with each successful attack. It instinctively strikes for an opponent's eyes. If the sitak succeeds in a strike with a natural attack roll of 20, it has hit the victim's eyes (if they are unprotected), blinding the victim for 2d10 rounds.

A pet sitak defending its owner, or a parent defending its nest, has a morale score of 12 (Steady).

**Habitat/Society:** Sitaks can make good pets. If confined in isolation, they go mad, but otherwise they are loyal (if rather demanding) companions. Wild sitaks have animal intelligence, but careful training from hatching can increase this to Semi- (2-4) in a pet. The pet always learns the word for "food" quickly and may understand up to 20 other simple words such as no, danger, animal names, and the like,



Trained sitaks can relay mindlink communication between two people telepathically. This silent dialogue works like the mindlink ability, except that it cannot cross language barriers. Also, the bird cannot handle more than two voices at a time, and it quickly tires—especially when hungry or quarrelsome, as it usually is.

**Ecology:** Sitaks are thought to mate for life, though information is scarce. The female lays one egg a year, in a huge nest of branches far larger than one would think necessary. A communal sitak nest may house several pairs in different "rooms," which can be large enough to harbor a halfling or dwarf.

Few predators attack sitaks, for their flesh tastes foul and stringy, but they are prone to both disease and parasites. "Sitak fever" can be passed to humans and demihumans who fail a Constitution check. It resembles severe influenza, and it can recur in one-week episodes indefinitely whenever the victim enters a forest or jungle habitat. A *cure disease* spell removes the sitak fever permanently.

Sitaks live throughout the Forest Ridge and (in much smaller numbers) in the Crescent Forest between Gulg and Nibenay. For some tribes of halflings, sitaks represent bad luck; explorers with pet sitaks suffer a -6 penalty to reaction rolls by halflings. Other tribes regard sitaks as harmless, but few take them for pets and none for food.

The hunters of Nibenay prize sitak feathers, and they have hunted the bird almost to extinction in the Crescent Forest. Nibeni merchants pay 1-3 ceramic pieces per crest feather. In contrast, Gulg's hunters value sitaks as pets, and they regard killing a sitak as an omen of bad luck.

## Nonplayer Characters



### Habban-Puy, Fetish Keeper of Gulg

Human Male Defiler

15th Level

Neutral Evil

Str 8                      Dex 12                      Con 15

Int 20                      Wis 11                      Cha 13

hp: 24

AC: 10

#AT: 1

THACO: 16

Dmg: 1d4 + poison type L (bone dagger)

Spells—1st Level: *Affect normal fires, armor, burning hands, magic missile, wall of fog*; 2nd Level: *Darkness 15' radius, flaming sphere, invisibility, knock, summon swarm*; 3rd Level: *Dispel magic, fireball, fly, haste, lightning bolt*; 4th Level: *Dimension door, ice storm, minor globe of invulnerability, polymorph others, wall of fire*; 5th Level: *Chaos monsters, cloudkill, monster summoning 111, passwall, wall of stone*; 6th Level: *Chain lightning, stone to flesh*; 7th Level: *Finger of death*

Habban-Puy is distantly related to the Forest Queen, though the latter is far, far older than her cousin (exactly how much older, even he does not know). As Fetish Keeper, he is Lalali-Puy's chief defiler and official guardian of her personal idols and magical items. A number of the fetishes that Habban-Puy keeps for the Oba are, in fact, magical in nature. Many others are not. For purposes of ceremony, the matter of true magical enchantment is unimportant.

#### *During Astician Gambit*

Habban-Puy feels he is in a very tenuous position. In his mind, the Forest Queen could reconsider his position at any time, and he might find himself on the wrong end of a Red Moon hunter's spear. To keep his position secure, Habban-Puy is very jealous of those who gain the Oba's ear, and so takes extreme measures to keep newcomers away from his queen. He will



see to it that the PCs are arrested and sent to the dungeons during this adventure.

#### *After Astician Gambit*

Assuming the PCs survive the Red Moon Hunt and the rest of this adventure, Habban-Puy's attitudes toward them will be very different. Should he ever again meet and recognize the PCs, he will be quite impressed by their longevity. Always in need of able hirelings, Habban-Puy may approach and offer employment, most likely without the knowledge of the Forest Queen. Finding and securing new fetishes is Habban-Puy's never-ending task.



## Astician Gambit

### Mogadisho, Warlord of Gulg

Human Male Templar  
15th Level  
Neutral Evil

Str 19            Dex 17            Con 14  
Int II            Wis 10            Cha 17

hp: 50

AC: 8 (-3 due to dexterity)

#AT: 1

Dmg: 2d4 (*bronze broad sword +1*)

Wild Talent: Know Location; PS 11; Cost 10; PSP 40.

Spells—1st level: *Animal friendship, create water, cause light wounds, curse, light*; 2nd level: *Aid, barkskin, flame blade, speak with animals, spiritual hammer, silence 15' radius*; 3rd level: *Animate dead, create food & water, dispel magic, locate object, summon insects*; 4th level: *Animal summoning I, cloak of bravery, produce fire, rejuvenate, sticks to snakes*; 5th level: *Animal summoning II, cause critical wounds, flame strike*; 6th level *Blade barrier, wall of thorns*; 7th level: *Firestorm*.

In the cities of the sorcerer-kings, it is the templars who command the armies. Mogadisho is Lalali-Puy's chief warlord, the man she sends on important or sensitive tasks. His men are fanatically loyal to him, or they are put to the sword.

### During Astician Gambit

Mogadisho's tasks are assigned by the sorcerer-queen herself, and he carries them out to the letter. During this adventure, his task is to secure the necklace. Mogadisho's arrogance keeps him at a distance from the PCs—even if they perform well in battle, the warlord has nothing but scorn and mekillot spit for them. Mogadisho has no real concern with the court, so he avoids it whenever possible.



### After Astician Gambit

Mogadisho has no regard for any discipline other than his own. In future encounters Mogadisho may consent to speak with warrior PCs, but he'll treat all others as slaves. If the Oba might still be angry with the PCs, he will turn them all over to her palace guards.

It may be possible to join Mogadisho's personal bodyguard as one of the few non-native Gulgese troops. The PC would have to show great skill and no pity in the presence of the warlord to gain such an invitation. There's only one way out of Mogadisho's service—death.

## Nonplayer Characters



### Shala, Hunt Mistress

Human Female Fighter/Psionist  
15th/10th Level  
Neutral Evil

Str 17            Dex 20            Con 18  
Int 17            Wis 15            Cha 13

hp: 66

AC: 10 (-4 due to dexterity)

#AT: 2

THAC0 6 (+1 due to strength)

Dmg: 1d8 (steel scimitar, +1 due to strength)  
1d8 (long bow)

Psionics:

Sciences (5)—disintegrate (II), mindlink (I0), psychic crush (II), superior invisibility (I4), telekinesis (I2).

Devotions (I5)—animate object (I6), attraction (II), awe (II), ballistic attack (I6), ego whip (I2), ESP (II), inflict pain (I4), invincible foes (I2), invisibility (I4), levitation (I2), life detection (I7), mind thrust (I3), molecular agitation (I5), psionic blast (I0), soften (I7)

Att Modes: PsC, EW, MT, PB

Def Modes: M-, TS, MB, IF, TW

PSPs 227.

Lalali-Puy's chief hunter participates in the Red Moon festivities every year, more to demonstrate her superiority than for any other reason. There are dozens of nobles who would enjoy besting her and taking her place in the Oba's eyes, but so far none have managed to do so.

### *During Astician Gambit*

As the hunt progresses and, one by one, the other prisoners become accounted for, Shala realizes that the PCs are the best prisoners in the hunt. Toward maintaining her position as chief hunter, Shala tracks the PCs to prove herself. She has no regard for their lives, but may come to respect their cunning.



### *After Astician Gambit*

Should the PCs escape the Red Moon Hunt, they will be among the few ever to have done so. Shala will be most impressed, and she'll do everything she can to recapture the PCs and bring them to the hunt again. Shala is not terribly subtle, and neither are most of her hirelings. In time it will become clear to the PCs that "brutes from Gulg came through here looking or you." If it isn't quite time for the hunt, Shala may organize a game all for herself instead.



## Astician Gambit

### Taibela, Chief of Thieves

Human Female Thief

14th Level

Chaotic Evil

Str 17            Dex 13            Con 15

Int 14           Wis 9            Cha 12

hp: 54

AC: 8 (*leather armor +1, -4 due to dexterity*)

#AT: 1

THAC0: 14 (+1 due to strength)

Dmg: 2d4 (steel broad sword, +1 due to strength)

Wild Talent: Flesh Armor; PS I2; Cost 8/4; PSP 60

Taibela's duties to the sorcerer-queen are common knowledge. When the Oba sees an item she would like to own, she sends her chief of thieves to steal it. Then the sorcerer-queen displays the item in the presence of the original owner, who doesn't dare comment on the theft. This is just one part of Lalali-Puy's childish court maneuverings, a punishment for those she flees are too weak or are becoming too ambitious.

Other thieves in the city are considered criminals. When brought to the dungeons, Taibela often consults with them, convincing the condemned that she can get them released if they cooperate. After stripping their minds for skill and information (with the help of the court psionicists), Taibela invariably leaves the victims in the dungeons anyway.

### During *Astician Gambit*

Taibela's first goal during this adventure is one set up by the sorcerer-queen. She wants Taibela to steal a valued item from the PCs, then display it to see their reaction. Her skills are such that she will most likely be successful. The reaction of the PCs becomes unimportant, since they are accused and sent to the dungeons quickly after the theft.

Taibela may visit any PC thieves in the dungeon prior to the Red Moon Hunt. She only gets the chance to initiate a "friendship" before the Red Moon Hunt begins.



### After *Astician Gambit*

Taibela will want to interrogate any PC thieves if they ever come back to Gulg. To accomplish this, she will frame the PC with some item, claiming he stole it from her servants. Once placed in the dungeon, the PC will be confronted and psionically investigated under the false promise of freedom.

# Master NPC List

Name	CL	AC	MV	HD/hp	#AT	Damage (penalties and bonuses included)	AL	THAC0 <sup>1</sup>
Anakore <sup>2</sup>	-	8	9/ 15 Br	3d8	2	1d4/1d4	NE	17
Belgoi	-	7	12	5d8	2	1d4+2/1d4+2	LE	15
Caravan Guards, human	F4	10	12	4d10	1	1d6 (mace)	N	17
Elf of Black Spear Tribe	F5	10	12	5d10	1	by weapon	CN	16
Gith	-	8	10	3d8	1	1d6	CE	17
Gulgesse mul guards	F4	10	12	4d10	1	1d6	N	17
Gulgesse templars <sup>3</sup>	Te4	8	12	4d8	1	1d6-1	NE	18
Habban-Puy, Fetish Keeper <sup>3</sup>	D15	10	12	10d4 + 5	1	1d4 + poison (bone dagger)	NE	16
Jozhal <sup>23</sup>	-	3	18	4d8	1	1d6	CN	17
Krr'ikk, thri-kreen warrior	-	5	18	6d8+3	5	1d4/1d4/1d4/1d4/1d4+1	CN	13
Kru'ist, thri-kreen	-	5	18	6d8+3	5	1d4/1d4/1d4/1d4/1d4+1	CN	13
Mogadisho, Warlord of Gulg <sup>23</sup>	Te15	5	12	9d8 + 12	1	2d4 +8 (bronze broad sword)	NE	12
Mogadisho's warriors	F2	8	12	2d10	1	1d6+1	N	19
Raiders, elven	F5	10	12	5d10	1	1d6	CN	16
Raiders, human	F4	10	12	4d10	1	1d6 (mace)	N	17
Raider, thri-kreen	-	5	18	6d8+3	5	1d4/1d4/1d4/1d4/1d4+1	CN	13
Sark, halfling hunter	F8	6	6	8d10	3/2	by weapon	LN	13
Semponius of Asticles	F6	5	12	6d10	1	1d8	NG	15
Shala, the Hunt Mistress <sup>2</sup>	F15/ Ps10	6	12	66 hp	2	1d8 + 1 (steel scimitar)	NE	6
Spunt the Jester <sup>2</sup>	Ps8	10	6	8d6	1	1d3	CE	17
Sylos, merchant	Tr8	10	12	8d8	1	by weapon	LG	17
Taibela, Chief of Thieves <sup>2</sup>	T14	3	12	10d6+8	1	2d4 + 1 (steel broad sword)	CE	14

<sup>1</sup>Does not include penalties or bonuses due to Str or weapon materials

<sup>2</sup>Possess wild talents or other psionics

<sup>3</sup>Possess spells

## How to Use Astician Gambit



The two spiral bound books here contain the role-playing adventure *Astician Gambit*. The *DUNGEON MASTER™ Book* contains each encounter the DM needs. Other parts of the *DUNGEON MASTER Book* provide background material the DM needs to run a series of encounters. The *Player's Book* contains maps, illustrations, and text the players need for reference. Players should not casually look through the *Player's Book*— the *DUNGEON MASTER Book* indicates when the players should turn to a page, and what page they should turn to. The *Story Book* contains a short story that broadens your understanding of the world of Athas. At the back of this booklet are detailed descriptions of various NPCs.

Each encounter in the *DUNGEON MASTER Book* contains information arranged under the following headings.

**Setup.** This section tells the DM how to prepare for the upcoming encounter, including what page or pages of the *Player's Book* will be used.

**Start.** This section tells how to begin the encounter and usually includes a section to be read to the players.

**Encounter.** The main action of the encounter is detailed in this section.

**Role-Playing.** Descriptions of NPC personalities and tips on role-playing, including sample lines of dialogue are given here.

**Statistics.** Vital game statistics are given here or the DM is referenced to the Master NPC Table on the inside cover of the module.

**Reactions.** This section occasionally appears, when the anticipated reactions of PCs and NPCs are important to the encounter.

**Outcome.** This section indicates what should result from the encounter.

**Next.** This section tells the DM what encounter to run next.



# Astician Gambit

by Anthony Pryor



The palace of the Forest Queen contains treasures unimaginable. To the sons and daughters of Athas's harsher climes, Gulg and the Crescent Forest seem almost perversely lush, a jumble of green and growing things hording precious water for the benefit of the few. But while basking in the glow of Lalali-Puy's gratitude, your characters have the richness of the forest at your beck and call.



Of course, the Oba's sensibilities are easily bruised, and her nature is notoriously unforgiving. Gulg's dank dungeons are only a staging area to a deadly ceremony, where the young nobles of the city chase prisoners through the forest to earn their places as lords of their city—the Red Moon Hunt.

Designed for four to six characters of 7th to 10th level, *Astician Gambit* makes them pawns in a dangerous game between the Oba of Gulg, the Shadow King of Nibenay, and mysterious representatives of the Asticles family of Tyr. A stand-alone adventure, *Astician Gambit* can also be played as the sequel to *Freedom, Road to Urik*, and *Arcane Shadows*.

TSR, Inc.  
POB 756  
Lake Geneva  
WI 53147  
U.S.A.



TSR Ltd.  
120 Church End  
Cherry Hinton  
Cambridge CB1 3LB  
United Kingdom

U.S. \$12.95  
CAN \$15.50  
U.K. £7.99

ADVANCED DUNGEONS & DRAGONS is a registered trademark owned by TSR, Inc.  
DARK SUN, DUNGEON MASTER and the TSR logo are trademarks owned by TSR, Inc.  
Copyright ©1992 TSR, Inc. All Rights Reserved. Printed in the U.S.A.



Official Game Adventure

