

Castle Farkinwald



By Collin Terrell



This game references the *Savage Worlds* game system, available from Pinnacle Entertainment Group at www.penguin.com. *Savage Worlds* and all associated logos and trademarks are copyrights of Pinnacle Entertainment Group. Used with permission. Pinnacle makes no representation or warranty as to the quality, viability, or suitability for purpose of this product.

Acknowledgements:

Inspired by classic modules such as *Tomb of Horrors*, *Lost Caverns of Tsojcanth*, *Ghost Tower of Inverness*, *Into the Unknown* and more obscure favorites such as *Buffalo Castle* and the *Deathtrap Equalizer Dungeon*.

Cover picture by the great Erol Otus; originally printed on the back jacket of *Keep on the Borderlands*.

Setting:

The locals won't speak of it. Animals shun it. Adventurers share whispered rumors about it over the campfire's last embers. It is Castle Farkinwald. Built long ago by an intensely perverse wizard named Farkinwald the Fantastic, the castle that bears his name occupies a lonely mountain range in the middle of an uninhabited plain. Farkinwald never stirs from his lair giving rise to the notion every ten years or so that he's finally passed away, leaving his piles of incalculable wealth unattended. Adventurers, braggarts and drunks, fired by visions of becoming as wealthy as sultans, invariably risk everything to explore the truth of these rumors, never to return. The only question that matters however is: will *you* dare to brave the forlorn fastnesses of Castle Farkinwald?

This dungeon is supposed to kill you. Don't be discouraged by dying early, often and gruesomely. It's not intended to be fair; sometimes you will be killed simply for taking the wrong *Hindrances* or *Edges*. That's the way Farkinwald rolls.

Castle Farkinwald is intended to work with whatever swords-and-sorcery setting you'd like to run. Feel free to adapt it as you need to so that it will fit within your campaign of choice.

Why even attempt a dungeon like this? Well, it was designed as a one-shot so if you're just looking for something ridiculous to play with your gaming buddies for a night, this'll give you some laughs. If you're of a more serious frame of mind, you can play this tournament style and see who amasses the most points by the end of the night. If your campaign allows for easy resurrection magic, you could place this dungeon in your world as a sort of "sports dungeon" that adventurers go through while fans watch via crystal balls and other divination magic.

Getting Started:

This adventure is recommended for parties of *Seasoned* rank or higher.

The dungeon is randomly constructed. Every time you enter it, the layout of corridors and rooms changes. If you're the planning type, you can pre-generate the full dungeon before play begins. Alternatively, if you like to fly by the seat of your pants, you can also randomly generate the dungeon as the party explores it. If you are going to generate the dungeon as it runs, remember to map it out as you go in case the party decides to backtrack.

Prepare two decks of playing cards to serve as your *Encounter Deck*. You will want these two decks to be visually distinctive from each other (I use a blue deck and a red deck). Shuffle the two decks together, including the Jokers. This is the deck you will use to generate new rooms when the party explores a new hallway.

Adventurers always enter Castle Farkinwald through the *Entrance Chamber* encounter. As they uncover new rooms you will draw them randomly from the *Encounter Deck* and draw them on the map. Each room is connected to the others by a 10' wide corridor of no less than 60' in length.

Play continues until a *Joker* is pulled from the *Encounter Deck*. At that point, three more encounter cards are drawn. After those three rooms are explored, the fourth room that the party will encounter is the *Dragon's Den*, which represents the end of Castle Farkinwald.

Adventure Notes:

Complications & Twists:

Assuming you end up running this dungeon more than once, some suggestions for how you can switch-up an encounter are provided in the "Complications & Twists" section of each room.

Dealing with overly cautious Dungeon Delvers:

Players will often try very strange things to get out of scenarios that seem hopeless. One tendency that often emerges when you realize you're in a dungeon full of traps is to slow down and test each brick in the floor, walls and ceiling with a 10' pole before stepping anywhere. This type of caution, while laudable, can kill the momentum of the game. To discourage parties from performing a forensic analysis of every square inch of the dungeon, the Game Master is strongly encouraged to throw Wandering Monsters at parties that are too cautious.

Another favorite tactic is for the party to hole up in a dungeon room, iron spike all the doors shut and rest up to replenish power points and heal wounds. This is guaranteed to attract the attention of a Wandering Monster, several of which are either able to bypass solid obstacles or bash a door to smithereens.

If the party is desperate to replenish themselves, the best way is to send some of the party out of the dungeon to rest outside while others remain inside to keep the dungeon from resetting. This, of course, is incredibly risky. There are one or two rooms within Castle Farkinwald where a character can receive medical aid but these are few and far between by design.

Disbelieving Illusions:

At various points within the Castle characters may come into contact with illusory effects. Under ordinary circumstances an illusion is undetectable until it is interacted with. In some cases, the illusion is so potent that it even stands up under tactile inspection. These sorts of illusions can cause real harm to an adventurer unless they are able to disbelieve the effect. A character attempts to disbelieve an illusion by making a *Smarts* roll opposed by the *Spellcasting* skill of the illusionist. Unless otherwise stated, assume that all illusions in Castle Farkinwald have d12 potency.

Doors:

The doors in this dungeon are all double doors of exceptionally sturdy construction. In a number of instances the doors will self-lock and bar themselves, forcing the party to choose alternative exits. If someone is persistent in their desire to break a door down, they must succeed a *Strength* -8 check.

The party will learn very quickly that listening at doors is a good policy. Usually some audio clue will give them an idea of what they might face on the other side. Each room description includes a section that elaborates on what can be heard through the door. To listen at a door simply make a *Notice* check. Some doors may impose a penalty because the sounds, if any, are very faint or indistinct.

To avoid having everyone listen at every single door delegate the person with the best *Notice* skill to check for the entire party.

Gaming Aids:

You will need several decks of cards handy to play this adventure. Easy access to a chessboard is also recommended. In Appendix D you will find some additional cut-outs and player aids that may come in useful during your session.

Number of Exits:

Each room has a certain number of exits listed in its description. Unless specifically noted in the text, assume the exits are laid out like the diagrams below.

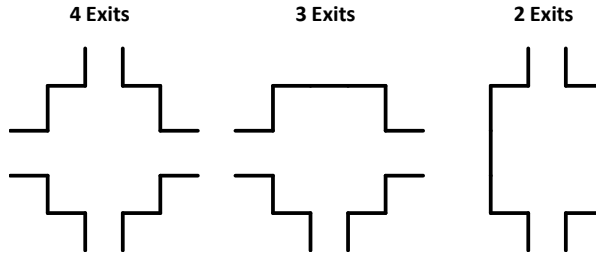

Unnatural Aging:

If a character should happen to run afoul of magic that alters their age, consult the table below for age-related statistical adjustments (assumes that the affected character was in the prime of their lives before the aging event occurred):

Years	Modifiers
0-15	Two die step decrease to <i>Strength</i> and a one die step decrease to <i>Spirit</i>
15-35	Normal; no modifiers
35-50	Suffer a -1 penalty to <i>Natural Healing</i> checks and a +1 to all rolls on the <i>Injury</i> table
50-70	One die step decrease to <i>Vigor</i> and a +2 to all rolls on the <i>Injury</i> table
70-80	Suffer a -2 penalty to <i>Natural Healing</i> checks and a +3 to all rolls on the <i>Injury</i> table
80-90	-2 to <i>Pace</i> and a +4 to all rolls on the <i>Injury</i> table
90+	Two die step decrease to <i>Vigor</i> and a +5 to all rolls on the <i>Injury</i> table

Rewards:

If a room has some sort of specific reward or treasure within it, the *Rewards* section of the encounter text will describe it.

Room Size:

Unless specifically indicated in the text, consider each room to be 50' by 50' in size (10 squares by 10 squares on a standard battle mat) with a 10' high ceiling.

Visibility:

Unless specifically noted in the text, consider the entire dungeon to be lit by magical ever-burning torches.

Weight Matters:

There are certain situations in this dungeon where a character's weight may come into play (for example, determining whether or not a character triggers a pressure plate). It is recommended that each player has a rough idea how much his or her character weighs, at least to the closest 50 pounds (22.5 kilograms). Here are some guidelines to help you determine average weights:

Avg. Male Weight	Avg. Female Weight	Full Plate Armor	Leather Armor	Gold
166	144	50	15	1 (per 16 coins)

Encounter Summary:

Card	Room	Synopsis	Page
Blue 2 ♣	The Kennels	Room lined with cages containing Farkinwald's feral pets. Wouldn't it be a shame if they got out?	13
Blue 3 ♣	The Abattoir	Various torture implements line the walls of this blood-splattered room. A hooded torturer eyes you maliciously!	14

Blue 4 ♣	The Armory	Racks of arms and armor fill this area. Several suits of armor animate when you enter.	15
Blue 5 ♣	The Smithy	A roaring forge bathes this room in uncomfortable heat. You've interrupted a burly smith with an improbably large hammer. He turns to pound some sense into you.	16
Blue 6 ♣	Farkinwald's Lab	An arcane laboratory filled with beakers, alembics and vessels containing strange, colorful liquids. Sample them at your own risk.	17-18
Blue 7 ♣	Torture Garden	Elaborate topiaries, shrubs and exotic flowers populate this open air walled garden. Sure looks peaceful, doesn't it?	19-20
Blue 8 ♣	The Jail	Dry bones and bedraggled prisoners occupy a number of jail cells here. Lording over them is a cruel, whip-wielding demonic jailor.	21
Blue 9 ♣	Garbage Pit	The floor of this room is recessed by 10' and is filled to the brim with smelly garbage. Parasites and scavengers lurk in the filth.	22
Blue 10 ♣	Gladiator Arena	This vast room contains a fighting pit. A number of gladiators battle one another to the death. To pass this room the party must appoint a champion to defeat the gladiators.	23-24
Blue J ♣	Throne Room	An impressive, gem-studded throne occupies the center of this room. Why don't you take a load off and have a seat?	25
Blue A ♣	The Harem	A boudoir festooned with silks and satin. Three veiled concubines turn languidly toward you as you enter.	26
Blue Q ♣	Room of Mysterious Pools	This large chamber contains a number of soaking pools filled with an assortment of strange liquids. Sample them at your peril.	27
Blue K ♣	The Chessboard	The floor of this large room is patterned in black and white chequy. Arrayed on the far side are two ranks of man-sized statues carved from black onyx. How well do you know the game of kings?	28-29
Blue 2 ♦	The Zoo	This menagerie contains an assortment of exotic creatures collected by Farkinwald during his travels. Don't feed the animals!	30-31
Blue 3 ♦	The Golem Factory	A baroque machine churns out new golem soldiers for Farkinwald's personal army. Try to shut it down before things get out of control.	32
Blue 4 ♦	Hall of Mirrors	A floating Eye Tyrant has made this mirrored room its lair. Watch out for deflections from its eye beams!	33
Blue 5 ♦	The Slammer	The walls of this room are crusted with dried gore. Anyone who attempts to cross the room triggers a wall crushing trap.	34
Blue 6 ♦	The Crypt	Grave dirt covers the floor of this sepulcher. Take care not to disturb the tenants.	35
Blue 7 ♦	Summoning Chamber	A powerful demon is trapped inside a summoning circle. He promises to fulfill a single wish for the person who frees him.	36

Blue 8 ♦	The Drain	The entire floor of this room is funnel-shaped. A steady stream of water from the ceiling pours down the funnel's sides.	37
Blue 9 ♦	Courtyard of Stampedes	This large courtyard is filled with herd animals. As you open the door, the animals become spooked and stampede toward you!	38
Blue 10 ♦	The Storage Room	A room that is densely packed with crates, barrels and sundry goods. Hidden somewhere in here might be another way out.	39
Blue J ♦	The Barracks	A number of bunks line the walls of this room. A detachment of guards are sleeping here. If you're careful you might be able to avoid them.	40
Blue A ♦	Guard Room	Armed and armored guards are on duty here. They've been given strict orders to deny all intruders.	41
Blue Q ♦	The Runic Gate	The only other exit from this room is a runic arch filled with shimmering energy. Perhaps if you could translate the runes you'd learn something of its purpose?	42
Blue K ♦	The Museum	Six valuable artifacts rest here on marble plinths. Two imposing iron golems maintain a silent watch.	43-44
Blue 2 ♥	The Banquet	Noldrath the Mad Lich is hosting a special dinner party and you are his honored guests! It would be impolite (and dangerous) to refuse.	45-46
Blue 3 ♥	Sphere of Death	A bowl-shaped room containing an ominous looking black sphere that floats menacingly in the center. You don't think touching it would be such a good idea.	47
Blue 4 ♥	The Birdcage	Two crystal cages suspended by a pulley system hang over a pool of caustic acid. You will need to get from one to the other somehow to cross this room.	48
Blue 5 ♥	Thieves' Gauntlet	This hallway is filled with an array of lethal traps. It'll take someone nimble and alert to survive the gauntlet.	49
Blue 6 ♥	The Tiled Hall	This garishly tiled hallway is entirely rigged with pressure plates. Step carefully!	50
Blue 7 ♥	The Cloak Room	The walls of this room are lined with cloaks and jackets hanging on hooks. There are no apparent exits from this dimly-lit chamber.	51
Blue 8 ♥	Room of False Doors	The entire perimeter of this room is filled with doorways. Most of the doors are false and conceal traps.	52
Blue 9 ♥	Teleportation Chamber	This chamber appears to be completely empty save for a shaft of light in the room's center. Anyone who steps into the beam teleports to a random location.	53
Blue 10 ♥	The Kitchen	A food preparation area with fully stocked pantry. The kitchen is staffed by monstrous minions in the service of a foul demon called "The Chef".	54
Blue J ♥	Courtyard of Soldiers	This open courtyard is filled with soldiers armed for battle. Upon seeing you they charge	55
Blue A ♥	The Rope Bridge	A bottomless chasm splits this room in twain. Spanning it is a rickety rope bridge. Surely it will hold your weight?	56

Blue Q ♥	Fungus Forest	A large chamber filled with towering mushrooms and a profusion of colorful fungi. The spores cause unusual allergic side effects.	57
Blue K ♥	The Shaft	The recessed floor of this room is filled with sharp spikes. You must climb a series of bars and ledges to make it to a trap-door in the room's ceiling high above.	58
Blue 2 ♠	The Pantheon	This is a quiet place of worship dedicated to a trio of random deities. You can pray to receive boons.	59-63
Blue 3 ♠	The Duelists	Two knights are doing battle with one another in this sparring chamber. One is dressed in black plate mail and the other is dressed in white scale. Both promise rewards in exchange for assistance.	64
Blue 4 ♠	The Champion	An imposing, plate mail clad warrior guards the only other exit from this room. He booms a challenge at you.	65
Blue 5 ♠	The Treasure Vault	A pile of glittery, tantalizing treasure lies just out of reach beyond a barred gate. I wonder if it's trapped?	66
Blue 6 ♠	Anti-Gravity Chamber	This spherical chamber has been enchanted with an anti-gravity field. The strange tentacled beasts dwelling here seem to have an affinity for zero-g.	67
Blue 7 ♠	The Magnetic Chamber	Anyone using metal armor or weapons is swept off their feet and slammed into a magnetized meat grinder. The party's mage chuckles.	68
Blue 8 ♠	Monster Explosion	This room is packed to the ceiling with a bunch of random monsters. As soon as you open the door they come spilling out.	69
Blue 9 ♠	Farkinwald's Bedchamber	This lavishly appointed bedchamber must belong to Farkinwald himself! His fetching mistress eyes you speculatively.	70-71
Blue 10 ♠	Wheel of Fortune	A large wheel divided into colorful segments dominates this room. It looks like you may have to spin it if you want to unlock the room's other door.	72
Blue J ♠	The Watchers	Six large gargoyles hold sentinel over this room. Their eyes glow with an arcane light that suggest the work of magical bla bla	73
Blue A ♠	Chamber of Eternal Darkness	This room is blacker than the blackest black times infinity. All light sources are permanently extinguished. Be careful: you're likely to be eaten by a grue.	74
Blue Q ♠	Wind Tunnel	Gale force winds knock you off your feet and propel you toward a spiked wall. Your only way out is a 3' wide hole. Think skinny thoughts!	75
Blue K ♠	Chamber of Discs	The floor of this large chamber is filled with sharp, poisoned spikes. You must ride glowing energy discs to make it to the other side.	76
Blue Joker	Three more rooms to go!	Draw three more cards. After these 3 rooms are defeated, move on to the final encounter: <i>The Dragon's Den</i> . If you draw another Joker, add 3 more rooms.	

Red 2 ♣	Poison Gas Chamber	Unhealthy looking green vapors seep into the hallway when you open the door to this room. Holding your breath would be advisable.	77
Red 3 ♣	Blazing Inferno	This passageway is filled with roaring illusory flames! Better bring your illusory fire extinguisher with you!	78
Red 4 ♣	The Freezer	The walls and floor of this room are covered with a thick layer of ice. You see the distinctive forms of frozen humanoids. Every moment you spend here increases the risk of freezing to death.	79
Red 5 ♣	The Door Golem	The only other exit from this room is barred by a smart-aleck door golem. It refuses to let you pass.	80
Red 6 ♣	Murder Holes	You must scale a fortified position guarded by hobgoblin soldiers if you want to pass this room.	81
Red 7 ♣	The Downward Spiral	A spiral staircase descends into darkness. Bad things tend to live in dark places.	82
Red 8 ♣	The Proving Ground	A band of mischievous kobolds have managed to get their paws on some experimental wands and they're blasting everything that moves.	83
Red 9 ♣	Golem Boxing	The door opens to a 40' drop. Standing near the doorway is a 40' tall golem. Across the way is another, equally tall golem. It looks like there may be some kind of control system on the golem's head...	84
Red 10 ♣	The Infirmary	Clean beds, bandages and unlabeled potions are located here. The party can take their ease to heal non-critical wounds.	85
Red J ♣	The Riddler	A carved sphinx guards the only exit from this room. You must answer its riddles to pass.	86
Red A ♣	The False Treasure Vault	A pile of glittery, tantalizing treasure lies just out of reach beyond a barred gate. Too bad it's fake!	87
Red Q ♣	The Anti-Magic Room	This room is deadly to all magic. Magic items are at risk of being permanently nullified.	88
Red K ♣	Gates and Levers	A number of lever-actuated portcullis gates divide this room into a grid. Several monsters are trapped in the grid. You will need to risk releasing some to get to the exit.	89
Red 2 ♦	The Flood	At first glance this room seems normal, but the exits are damp to the touch. What will be released when you open them?	90
Red 3 ♦	The Blender	A room filled with magical whirling blades. It will take a gymnast's agility to make it through unscathed.	91
Red 4 ♦	Courtyard of the Damned	The door opens upon a large courtyard filled with clinging mists. This area has been turned into a graveyard. Shambling figures lurch toward you.	92
Red 5 ♦	Hall of Archers	Six archers behind an archery blind hold watch over this long hallway. Can you reach them before becoming a pin-cushion?	93
Red 6 ♦	Hall of Illusions	This room isn't what it appears to be. A devious arachnid illusionist has woven a phantasmal web.	94
Red 7 ♦	The Beer Cellar	This cool cellar is filled with large casks of beer. Feel free to sample Farkinwald's Private Reserve, but mind any drunk demons you might bump into.	95

Red 8 ♦	The Tumbler	This entire room is rigged to flip once a pressure plate is activated. Occupants sustain falling damage as “up” and “down” get assigned new addresses.	96
Red 9 ♦	Hall of Chains	The floor of this room drops off beyond your field of vision. Numerous lengths of chain hang suspended from the ceiling. You will have to swing from chain to chain to cross the room.	97
Red 10 ♦	The Magic Cube	A strange, metallic cube floats in the center of this room. The top face of the cube yawns open as if waiting for something to be placed inside of it.	98
Red J ♦	Drowning Pool	The floor of this room is filled with brackish water. You will need to swim to the bottom to find the way out.	99
Red A ♦	Slime Chamber	The entire walls, floor and ceiling of this room are covered with viscous green slime. Wonder if it’s dangerous to touch?	100
Red Q ♦	The Stone Lady	An exquisite statue lies on what appears to be a funeral bier. A work of such magnificent detail could fetch a tremendous price from the right collector.	101
Red K ♦	The Magma Cave	The floor of this room is filled with molten lava. You will have to jump on several basalt pillars to make it across.	102
Red 2 ♥	The Crystal Chamber	This chamber is carved from solid quartz crystal. The torches lighting this place sting your eyes with blinding reflections.	103
Red 3 ♥	Lord of Bones	A multi-limbed bone golem leading a pack of skeletal minions guards this room. All must pay respects to the Lord of Bones!	104
Red 4 ♥	Slide Chamber	The floor of this room is greased and sharply sloped toward three chutes that drop you unceremoniously into a random room.	105
Red 5 ♥	The Ascent	The other exit from this room is a narrow tunnel that can only be reached by scaling a 40’ wall.	106
Red 6 ♥	The Invisible Bridge	A bottomless chasm separates you from the room’s other exit. There is no apparent way to cross.	107
Red 7 ♥	Chamber of Faces	Giant carved stone faces adorn the three walls of this room. They are carved in the likenesses of a dragon, a demon and a man.	108
Red 8 ♥	Chamber of Mists	This room is filled with swirling silver mist. Visibility is virtually nil.	109
Red 9 ♥	The Soul Organ	This room is occupied by a huge pipe organ constructed out of bones and ebony wood. You don't see any exits from this chamber.	110
Red 10 ♥	Dealing with Death	A robed skeletal figure sits alone at a table with a deck of cards and a stack of black chips near at hand. It slowly turns its gaze to you as you enter.	111
Red J ♥	The Catapult	The party must use a catapult to launch themselves up onto a high ledge where the exit sits. A moat of green slime waits below for those that miss.	112
Red A ♥	The Scrambler	A wall of crackling energy divides this room into two halves. You will need to step through transmogrifying	113-114

		devices to make it to the other side.	
Red Q ♥	The Sand Chamber	A treasure chest occupies the center of this cylindrically shaped room. Far above you see a trap door in the ceiling. You'd need to fill this room with something like, I don't know, sand to reach that.	115
Red K ♥	The Cursed Blades	You've heard the one about the "Sword in the Stone" right? Well this room has three of 'em.	116
Red 2 ♠	Burn Notice	The floor of this room is covered with viscous lamp oil. It sure would be a shame if someone dropped a match.	117
Red 3 ♠	The Troll Machine	A hole in the ceiling drops troll parts into a time trap that accelerates aging. Unless the mechanism can be stopped the whole room will fill with trolls.	118
Red 4 ♠	Time Bomb	Another room with an unattended chest sitting in the center? Yeah, we're not falling for that one again! Wait, why did that magic mouth just say the room is going to self-destruct?	119
Red 5 ♠	Broken Elevator	The only way this room is going is down.	120
Red 6 ♠	The Shocker	A persistent buzzing sound tells you that the floor of this room is electrified. Did you bring any rubber boots by chance?	121
Red 7 ♠	The Hole in the Wall	The main feature of this room is a mysterious black hole in one of the walls. Real adventurers aren't afraid to stick their arms into mysterious black holes!	122- 123
Red 8 ♠	Thin Ice	A collapsing staircase deposits the party in a room floored with thin ice. It doesn't take much to cause it to break.	124
Red 9 ♠	The Balance Test	Thin planks, beams and ramps criss-cross a room filled with sulfuric acid.	125
Red 10 ♠	The Great Underground River	The party must pilot a skiff down a treacherous underground river to make it to the next door.	126- 127
Red J ♠	Hand Locks	All of the doors exiting this room have hand-sized slots in the place where door handles should be. It looks like the party's thief has their work cut out for them.	128
Red A ♠	Second Exit	At last! Another way out from this crappy dungeon!	129
Red Q ♠	Empty Room	This room is totally empty. Seriously, there's nothing going on here.	130
Red K ♠	Farkinwald Lives!	A surly old wizard glares at you over the rim of his spectacles when you enter this room. You don't think he's happy to receive visitors.	131- 132
Red Joker	Three more rooms to go!	Draw three more cards. After these 3 rooms are defeated, move on to the final encounter: The Dragon's Den. If you draw another Joker, add 3 more rooms.	

Wandering Monsters:

There's a 5% percent chance of running into a wandering monster when you enter a hallway space. If you attempt to camp within the walls of Castle Farkinwald there is a 100% chance of having an encounter.

You can find full statistics for all Wandering Monsters in Appendix C. If this encounter table gets stale, feel free to build your own from the monster list at the end of the module.

Card	Encounter Name	Encounter Description
2	The Janitor	A massive Gelatinous Cube slurps toward you as it does the rounds picking up trash.
3	Clay Golem	This Golem is immune to damn near everything. Try bad language.
4	Black Pudding	The Black Pudding slithers up to you, spreading itself out to block your escape.
5	Rust Monster	You hear a skittering noise and then the Rust Monster is upon you!
6	Magic Eater	You hear a skittering noise and then the Magic Eater is upon you!
7	Umber Hulk	You thought that loud clacking sound was just your imagination until this 10' tall insect came barreling into your picket.
8	Xorn	Pursuing the scent of tasty gemstones, the Xorn burrows its way up into the party's midst.
9	Spectre	Evil and cunning, the spectre attacks the party from within the walls and floor of the dungeon.
10	Owl Bear	You hear a strange bellow between a hoot and a roar and then see the Owl Bear as it comes trundling toward you
J	Intellect Devourers (1d3+1)	Ravenous Intellect Devourers come bounding toward you like a pack of over-enthusiastic golden retrievers.
Q	Mind Flayer	The Mind Flayer will attempt to <i>Stunning Blast</i> the party from stealth and then stroll in for some leisurely brain eating.
K	Invisible Stalker	Unheard and unseen, an Invisible Stalker glides into your camp and begins rending the weakest party members.
A	Balrog	The temperature suddenly rises and a red glow fills the passageway. You hear the ominous, booming footsteps of something huge heading your way!
Joker	Farkinwald the Fantastic	The man himself has decided to take a turn about the grounds. He's none too happy to find transients loitering in his hallways. Better make a good impression or you'll get Zotted! (Refer to the <i>Farkinwald Lives!</i> encounter for details)

Entrance Chamber

Listen: You hear nothing.

You descend down a long, gently sloping passageway that is well-lit by flickering torches placed at regular intervals. After traveling about one hundred paces, you come into a simple looking room with doorways leading to the north, west and east.

This room is about as safe as any room gets in Castle Farkinwald. Even so, if the party tries to rest in here they will attract the attention of a wandering monster.

Complications & Twists:

- Seriously? OK how about this: you don't manage to find the entrance. Adventure over!

Number of Exits: 4

Rewards: None

The Kennels

Listen (-2): You hear muffled barking.

Three large cages line the left and right hand walls of this room. They are sealed with some kind of glass that muffles the baying of the hounds contained within. The hounds themselves are about the size of mastiffs but have unnatural looking green, rubbery skin and jet-black eyes. A door at the far end of the room appears to be the only other exit.

The glass walls of the cages are made of *Glassteel*, a magical material with a *Toughness* of 15.

A pressure plate in the middle of the room causes all of the cages to open, releasing the hounds. The plate is very sensitive, requiring only 50 lbs. of weight to set it off.

Complications & Twists:

- *The Kennelmaster* is here! This dog-headed mutant releases the hounds at once and attacks the party.

Number of Exits: 2

Rewards: One of the Trollhounds is wearing a nice dog collar encrusted with semi-precious stones. It is worth about 100 gold pieces.

Trollhounds (6)

Strength: d8	Smarts: d6 (A)	Agility: d8	Spirit: d6	Vigor: d8
Pace: 8	Parry: 6	Toughness: 6(5)	Fighting: d8	
Gear & Weapons: Bite (STR + d4)				
Edges & Powers: <i>Fleet Footed</i> (d10 <i>Sprint</i> die); <i>Go for the Throat</i> (attacks most vulnerable area on a <i>Raise</i>); <i>Fast Regeneration</i> (make a <i>Vigor</i> check each round to heal 1 <i>Wound</i> ; Fire and Acid prevent this); <i>Rubbery Hide</i> (Armor +1)				

"The Kennelmaster" Dog Mutant (WC)

Strength: d10	Smarts: d6	Agility: d6	Spirit: d6	Vigor: d8
Pace: 6	Parry: 6	Toughness: 8(7)	Fighting: d8	
Gear & Weapons: Flail (STR + d6; ignores Shields); Boiled Leather (Armor +1)				
Edges & Powers: <i>Scent</i> (+2 to <i>Notice</i> and <i>Tracking</i> rolls)				

The Abattoir

Listen (-4): You hear what may be a chain rattling and a blade being sharpened.

The contents of this room leave no doubts as to its purpose. Various implements of torture line the walls including an iron maiden, a stretching rack, a brazier of hot coals and an assortment of wall-mounted manacles. A number of wicked looking knives, pokers, pincers and hammers lay spread across a broad oak table. The most eye-catching sight in the room, however, is the 15' tall misshapen brute standing before you in an executioner's hood. Buboes, warts and visible tumors cover his pale skin. He clutches a hot iron poker in one meaty fist and bellows incoherently as he spins to face you.

The ceiling in this room is 20' high to accommodate the Torturer. He cannot be reasoned with.

Complications & Twists:

- Replace the Torturer with three *Cenobites*
- Replace the Torturer with a *Blood Golem*
- A human prisoner is being tortured in the iron maiden. If they are rescued, healed and safely escorted out of the Castle the party will gain 1 Experience Point.

Number of Exits: 3

Rewards: None

"The Torturer" Fomorian Giant (WC)

Strength: d12+3	Smarts: d4	Agility: d6	Spirit: d6	Vigor: d10
Pace: 7	Parry: 6	Toughness: 12(11)	Fighting: d6	
Gear & Weapons: Leather Armor (Armor +1); Hot Poker (STR + d4; 1 in 6 chance of combusting)				
Edges & Powers: <i>Improved Sweep</i> ; <i>Clueless</i> (-2 to all <i>Knowledge</i> rolls);				

The Armory

Listen: You hear nothing.

This room is clearly some sort of Armory; it is filled with all manner of melee weapons, bows, ammunition and suits of armor. As you enter the room, there's a clattering noise and you see several suits of armor float up from their stands and drift toward you eerily. Blades bob and weave in the grasp of disembodied gauntlets.

The walls of this room are completely lined with racks of weapons and armor stands. Characters can find any non-magical armor or weapon they wish.

Complications & Twists:

- A *Rust Monster* managed to find its way in here. It ate everything! All of the weapons and armor are gone and the Rust Monster is currently sleeping in the middle of the room.
- The *Armored Phantoms* are surrounded by an aura of *Cold Fire*. This damage shield inflicts 2d6 points of Cold damage against anyone who strikes it.
- Double the number of *Armored Phantoms*

Number of Exits: 3

Rewards: If a careful search is conducted (*Notice -4*) the party will find a nice suit of plate mail that has been painted with cheap gray enamel. It's actually *Plate Mail of the Sky*, a suit of sky blue plate that weighs half as much as regular plate mail. If reconditioned the armor would be quite eye-catching. During the search there's a 10% chance that a Wandering Monster may drop in.

Armored Phantoms (6)				
Strength: d6	Smarts: d4	Agility: d6	Spirit: d4	Vigor: NA
Pace: 6	Parry: 5	Toughness: 8 (2)	Fighting: d6	
Gear & Weapons: Short Sword (STR + d6); Plate Mail (Armor +6)				
Edges & Powers: <i>Undead</i> (+2 to recover from <i>Shaken</i> ; +2 <i>Toughness</i> ; immune to called shots)				

The Smithy

Listen: You hear the clang of metal on metal and the sighing of a bellows.

As you open the door to this room a wave of heat washes over you. You see a broad-chested, red haired giant working a massive forge. He seems oblivious to the heat with nary a bead of sweat appearing on his bronze skin. Everything in this room is proportioned to suit the giant smith: the ceiling is at least 25' high and the forge stands 10' tall. The giant pauses from his labors to note your entrance and measures you with a glance. You get the distinct impression that you don't rate very high in his estimations.

The Smith does not wish to be disturbed. He speaks the common tongue well enough and will tell the party to go back the way they came and leave him to his work. If they refuse or try to dissemble, the giant will grow impatient and attack.

This room is uncomfortably hot for anyone that lacks *Fire Resistance*. If the party remains here for more than 3 rounds they must make a *Vigor* check each round or gain a *Fatigue* level.

The Smith will only use his *Potion of Diminution* if he needs to escape or if he thinks he can pursue and finish off the party.

Complications & Twists:

- Replace the *Fire Giant* with a *Balrog* smith.
- Replace the *Fire Giant* with a *Gold Golem*.

Number of Exits: 3

Rewards: If you defeat the Smith and have a d12+1 or better *Strength*, you can wield his mighty hammer. Also, if anyone searches inside the forge (*Notice* -2) they will find a piping hot ingot of adamantium worth about 1000 gold pieces. Lastly, among the giant's personal affects is a bronze flask containing a *Potion of Diminution (Shrinking)*.

"The Smith" Fire Giant (WC)

Strength: d12+4	Smarts: d6	Agility: d6	Spirit: d6	Vigor: d10
Pace: 8	Parry: 6	Toughness: 14(12)	Fighting: d8	
Gear & Weapons: Oversized War Maul (STR + d12); Chain Mail (Armor +2)				
Edges & Powers: <i>Fire Aura</i> (all adjacent targets take 2d6 Fire damage per round and have a 1 in 6 chance of combusting); <i>Immune to Fire</i> ; <i>Improved Sweep</i> ; <i>Weakness: Cold</i> (Cold attacks inflict +4 damage)				

Farkinwald's Lab

Listen (-2): You hear a gentle bubbling sound as if a pot of water was boiling.

You have come across a fully stocked alchemical laboratory. The room is full of tables, cabinets and shelves storing glass vessels of every description. Liquids and powders of every hue fill these vessels. Your eye is drawn to an island in the center of the room upon which you can see what appear to be several recently distilled concoctions.

If any characters examine the table in the center of the room, they see the concoctions listed below. Anyone who tries to "pinky test" the potions by dipping their small finger into them and tasting them should refer to the appropriate entry below:

Potion Name	Pinky Test	Effect
Green Alembic	You are burned for 1d6 points of acid damage	<i>Aqua Regia</i> : super-strong acid that inflicts 2d10 points of damage. If consumed the imbiber must also succeed a <i>Vigor -2</i> check or die.
Red Erlenmeyer	No effect	This potion cures <i>Petrification</i> .
Black Phial	No effect	<i>Antidote</i> : this potion will negate the effects of any <i>Poisons</i> or <i>Diseases</i> that the imbiber is afflicted with.
Purple Beaker	No effect	<i>Potion of Polymorph</i> . Imbiber is transformed into a random creature for 1d4 hours (see <i>Polymorph Results</i> table below)
Golden Demijohn	Tastes like beer	One of Farkinwald's hobbies is brewing beer. This Demijohn (Carboy) holds his latest creation. It's truly excellent and very strong (<i>Vigor -2</i> to avoid getting drunk).
Clear Bath	Tastes like water	It's just water, people. Move along!
White Powder	Your finger becomes glued to your lips. Tearing it away causes you to temporarily suffer <i>-1 Charisma</i> due to the unsightliness of the wound.	When mixed with water, this powder creates a powerful adhesive.
Blue Retort	No effect	Roll on the <i>Potion</i> table in the <i>Savage Worlds Fantasy Companion</i> to determine the effect

Characters who have *Knowledge* of alchemy or magic can use the lab equipment to attempt to discern the effects of a potion without consuming a full dose (with a successful skill check). In addition, there's enough raw material here for a skilled potion maker to produce 1d6 *Potions of Healing* if they knew what they were doing.

If the laboratory is smashed or more than three potions are combined with one another, the mixture produces an *Arcane Ooze*, which appears in a puff of acrid smoke.

Complications & Twists:

- Randomly switch up the potions and their effects.

Number of Exits: 3

Rewards: Any of the potions can be removed from this room and used elsewhere.

Polymorph Results Table:

Card	Effect	Description
2	<i>Bunny</i>	Your <i>Strength</i> , <i>Agility</i> and <i>Vigor</i> dice are all reset to d4-2. Gain a +2 <i>Dodge</i> bonus and reduce your <i>Pace</i> by -2.
3	<i>Wolf</i>	Your <i>Strength</i> and <i>Vigor</i> dice are reset to d6. Your <i>Agility</i> is reset to d8. Gain a <i>Bite</i> attack (STR+d4) and increase your <i>Pace</i> by +2.
4	<i>Bird</i>	Your <i>Strength</i> , <i>Agility</i> and <i>Vigor</i> dice are all reset to d4-2. Gain a +2 <i>Dodge</i> bonus and the ability to <i>Fly</i> at <i>Pace</i> 12.
5	<i>Serpent</i>	Your <i>Strength</i> and <i>Vigor</i> dice are reset to d4. Your <i>Agility</i> is reset to d8. Gain a <i>Poison</i> attack (all targets bitten must succeed a <i>Vigor</i> -2 check or become incapacitated). Reduce your <i>Pace</i> by -2.
6	<i>Bison</i>	Increase <i>Strength</i> and <i>Vigor</i> by two die steps. Your <i>Agility</i> is reset to d6. Gain a <i>Gore</i> attack (+4 damage when charging)
7	<i>Cat</i>	Your <i>Strength</i> and <i>Vigor</i> dice are reset to d4. Your <i>Agility</i> is reset to d8. Gain <i>Night Vision</i> and a +2 bonus to all <i>Climbing</i> and <i>Leaping</i> checks.
8	<i>Ethnic Swap</i>	Statistics are unchanged. You skin, hair and eye color change, as well as your morphological features (i.e. face shape, body type, etc.)
9	<i>Elf</i>	One step die increase to <i>Agility</i> ; acquire the <i>All Thumbs</i> Hindrance. Gain <i>Night Vision</i> . +1 <i>Charisma</i> .
10	<i>Hobgoblin</i>	Statistics are unchanged. Gain <i>Night Vision</i> .
J	<i>Dwarf</i>	One step die increase to <i>Vigor</i> ; -1 <i>Pace</i> . Gain <i>Night Vision</i> .
Q	<i>Kobold</i>	Decrease <i>Strength</i> by two die steps; -2 <i>Toughness</i> . Gain <i>Night Vision</i> and a +1 <i>Dodge</i> bonus.
K	<i>Gargoyle</i>	Traits are unchanged. Gain <i>Flight</i> (can fly at your normal <i>Pace</i>) and <i>Armor</i> +2.
A	<i>Ogre</i>	Increase <i>Strength</i> by two die steps; +2 <i>Toughness</i> .
Joker	<i>Cambion Demon</i>	Gain <i>Demon</i> sub-type (+2 to recover from <i>Shaken</i> ; immune to disease and poison; 1/2 damage from normal weapons)

Torture Garden

Listen: You hear nothing.

This open air courtyard is filled with a colorful assortment of exotic plants. A well-maintained path winds between the beds, linking the room's four exits. In the center of the garden stands a very large willow tree with drooping branches. Each of the room's corners features another variety of plant: you can see roses, an apple tree, some orange poppies and kudzu.

Climbing Out:

Characters who wish to scale the 50' high walls can climb out of Castle Farkinwald. They'll find themselves somewhere within the grounds of the castle and will need to scale another 100' high wall to truly break free (since all of the gateways are underground). It is impossible to gain access to any other rooms of the castle by climbing out of this room -- from the outside the buildings of the castle are just windowless, door-less stone slabs for as far as the eye can see.

Location	Plant Type	Effect
A	Hangman Tree	See below for statistics
B	Dire Poppies	Hits nearby targets with orange pollen over a Large Blast Template area. Targets must succeed a <i>Vigor -2</i> check or fall asleep for 2d6 hours.
C	Strangle Ivy	See below for statistics
D	Golden Apples	Eating a Golden Apple heals 1 <i>Wound</i> . The tree can only produce 1d4+1 apples per season.
E	Vampire Roses	See below for statistics

Complications & Twists:

- Replace the *Golden Apples* with *Red Apples*. If anyone eats a Red Apple they must succeed a *Vigor -4* check or fall asleep for 2d6 hours.
- Replace the *Strangle Ivy* with *Blackthorne*, a virulently poisonous purple flower with a black, thorny stem. *Blackthorne* has the same statistics as *Strangle Ivy* but inflicts a *Poison* attack (*Vigor -2* or suffer one *Wound*) instead of a *Life Drain*.
- Replace the *Dire Poppies* with *Deadly Nightshade*. These purple mushrooms exude a lethal contact poison. Anyone who touches them with bare flesh must succeed a *Vigor -4* check or become *Incapacitated* by anaphylactic shock. If a second *Vigor -4* check fails, the victim dies of suffocation.

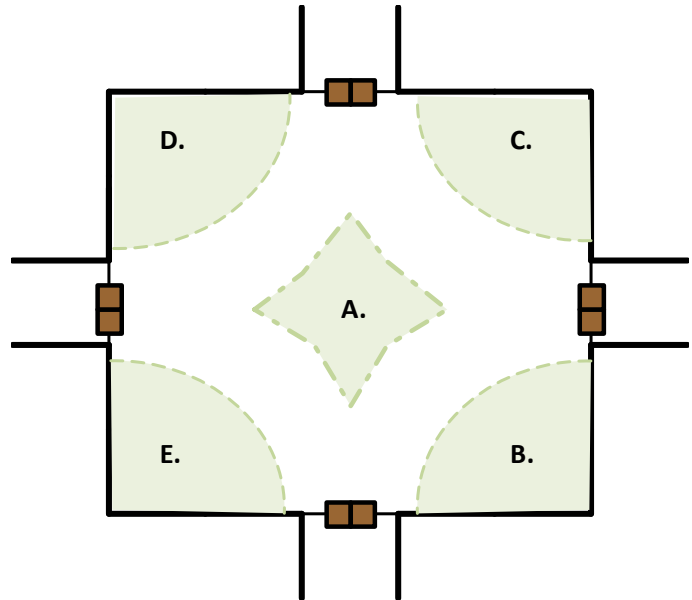

Number of Exits: 4

Rewards: None

Hangman Tree				
Strength: d12+1	Smarts: d4(A)	Agility: d6	Spirit: d10	Vigor: d10
Pace: 0	Parry: 6	Toughness: 15(13)	Fighting: d8	

Gear & Weapons: Bash (STR + d6)
Edges & Powers: <i>Reach +3; Bark Skin (Armor +2); Multiple Limbs</i> (can make 4 melee attacks per round with no multi-action penalty); <i>Grapple +4; Weakness: Fire</i> (sustains an extra 1d6 damage from Fire)

Strangle Ivy				
Strength: d8	Smarts: d4(A)	Agility: d6	Spirit: d10	Vigor: d6
Pace: 0	Parry: 5	Toughness: 10	Fighting: d6	
Gear & Weapons: Bash (STR)				
Edges & Powers: <i>Reach +2; Grapple +4; Weakness: Fire</i> (sustains an extra 1d6 damage from Fire)				

Vampire Roses				
Strength: d4	Smarts: d4(A)	Agility: d6	Spirit: d10	Vigor: d6
Pace: 0	Parry: 5	Toughness: 10	Fighting: d6	
Gear & Weapons: None				
Edges & Powers: <i>Reach +2; Life Drain</i> (+2 to hit; make a <i>Vigor -2</i> check or sustain 1 <i>Wound</i> ; Vampire Rose heals 1 <i>Wound</i>); <i>Weakness: Fire</i> (sustains an extra 1d6 damage from Fire)				

The Jail

Listen: You hear nothing.

Six large, glass-sealed cells line the walls of this room. You can make out the shapes of humanoid figures in some of the cells but from where you're standing you can't tell if they're alive or dead. A control panel of some kind occupies the far wall, next to the room's other exit. Barring your way is a large, corpulent figure with small horns and a barbed tail wearing a pair of spiked gloves.

Draw cards to randomly determine the occupants of the six jail cells:

Card	Cell Occupant
2-5	Bones
6-10	Nothing
J	An <i>Adventurer</i> . Will offer to join the party if rescued.
Q	A <i>Hobgoblin</i> . Will try to run away if freed.
K	A <i>Madman</i> in a straight jacket. Has the same statistics as an <i>Evil Human</i> . A foaming at the mouth lunatic.
A	A <i>Damsel</i> . Will earn the party 1 extra Experience Point and a 500 gold piece reward if safely escorted from the Castle.
Joker	<i>Invisible Stalker</i>

Using the Control Panel:

The control panel consists of three switches colored **Red**, **Green** and **Blue**. The **Blue** switch will open the cells and release the prisoners. The **Red** switch releases chlorine gas inside the jail cells and the **Green** switch releases chlorine gas in the room (but not in the cells). Victims must pass a *Vigor* -2 check or suffer 2d10 points of poison damage. The demon, of course, is immune to the gas.

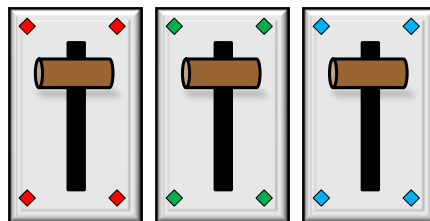

Complications & Twists:

- If any party members are subdued and captured, they will end up here in one of the cells.
- Replace one of the prisoners with a *Doppelganger*

Number of Exits: 2

Rewards: None.

"The Jailor" Demon (WC)				
Strength: d12	Smarts: d6	Agility: d10	Spirit: d8	Vigor: d12
Pace: 4	Parry: 7	Toughness: 8	Fighting: d10	
Gear & Weapons: Spiked Gloves (STR + d4)				
Edges & Powers: <i>Demon</i> (+2 to recover from <i>Shaken</i> ; immune to disease and poison; 1/2 damage from normal weapons); <i>Weakness: Cold Iron</i> (takes normal damage from Cold Iron); <i>Improved Frenzy</i> (2 attacks per round)				

Garbage Pit

Listen: You hear nothing but the smell of garbage is intense.

This room contains a large pit filled with garbage: body parts, food waste, bits of metal, some broken furniture and nightsoil. The only way out appears to be a chute located in the ceiling at least 40' above you. You can see a large red button on the wall on the other side of the refuse pile.

Activating the Compactor:

Once the large red button is pressed the door shuts behind you and the walls of the Garbage Pit begin to slowly close in. The garbage level in the room is pushed up by 5' every round. Each round the adventurers need to pass both a *Climb* and *Agility* check to stay on top of the trash heap. If you fail either check you become partially buried in the garbage, suffering a -2 penalty to all subsequent rolls. If you fail a second time you become completely buried and suffer a -4 penalty to all subsequent rolls. Fully buried characters become infected with a disease.

Eventually the garbage will be compacted high enough to allow the party members to reach the trap door in the ceiling.

Die Roll (d4)	Affliction
1	<i>Brain Eater Parasite:</i> This small <i>Dermaptera</i> (resembling an Earwig) hides itself in the host's clothing and waits until they go to sleep. It then wiggles its way into the host's ear canal so that it can lay eggs. The host gets to make a <i>Notice -4</i> check to detect the parasite before it can cause any harm. Once the Brain Eater is in the host's ear canal, the only way to flush it out is to use strong alcohol. The eggs take about a month to hatch. During that time, the host is subjected to excruciating headaches and suffers a -1 to all rolls. When the eggs hatch, the Brain Eater larvae feed on the host's brain tissue before exiting via the ear canal. The host suffers a permanent two step decrease to their <i>Smarts</i> die.
2	<i>Rot Grubs:</i> These thick maggots burrow tenaciously through living flesh. The host suffers 2d6 points of damage per round for 1d6+2 rounds as the grubs burrow toward the host's heart. If the grubs reach the heart, the host dies in agony. The only way to stop the Rot Grubs is to cut them out of the host. They have a collective <i>Toughness</i> of 4 (but any damage to the grubs also affects the host).
3	<i>Dire Fleas:</i> Not your garden variety fleas. These obnoxious pests feed on the blood of their hosts and leave itchy, inflamed sores all over the host's body. The host suffers a -1 to all rolls while they deal with the constant discomfort. The only way to truly get rid of the Dire Fleas is for the host to ingest something poisonous; the contamination of the host's blood puts the Fleas off for good.
4	<i>Filthy Shakes:</i> You've contracted the Filthy Shakes. After 1d6 hours you begin to feel feverish. Each day thereafter you gain a <i>Fatigue</i> level until you are incapacitated. After a day of incapacitation, the fever breaks and the character returns to normal (after receiving nourishment and bed rest, of course).

Complications & Twists:

- Instead of a Trash Compactor, the Garbage Pit is occupied by a Garbage Golem -- a massive construct made from the waste in the pit. The Golem rises up when the party opens the door. It is possible to try and climb up the golem's body to reach the trap door in the ceiling.

Number of Exits: 2. The only other exit from this room is a trap door located in the ceiling. Once the trash is compacted this room cannot be re-entered.

Rewards: A thorough search of the garbage (*Notice -4*) reveals a number of gold coins equal to the searcher's *Notice* roll x10. For each *Raise* the searcher also finds one random miscellaneous *Magic Item* (consult the *Savage Worlds Fantasy Compendium*). Searching the garbage exposes the searcher to a random disease (see above).

Gladiator Arena

Listen: You hear nothing.

This huge room contains a sand-floored fighting pit surrounded by rows of stone benches on risers. You can see three other exits from this room. As you enter, a stone mouth emerges from one of the walls and shouts, "SEND FORTH YOUR CHAMPION!"

Nothing else happens until one or more party members step into the pit. Once the contestants have entered the pit, a field of magical energy springs up around the perimeter of the arena preventing anyone outside the pit from interfering with the match. The mouth then bellows, "PREPARE TO FACE YOUR CHALLENGERS!" Roll a d6 on the table below for each contestant to determine who their challenger will be. A portcullis opens up and the challengers emerge, ready to fight.

Challenger Round:

Die Roll (d6)	Challenger
1	<i>Minotaur</i>
2	<i>Ogre</i>
3	<i>Hobgoblin</i>
4	<i>Evil Human</i>
5	<i>Owl Bear</i>
6	<i>Troll</i>

The party members can team up to take down the challengers or square off 1 on 1 if they wish. Once all of the challengers are defeated, the energy field will dissipate. Then read the following:

As you clean your weapons on the fallen gladiators, the magic mouth reappears and says, "CONGRATULATIONS ON SURVIVING THE CHALLENGER ROUND. YOU MAY NOW LEAVE THE ARENA IF YOU WISH. HOWEVER, IF YOU WOULD LIKE TO HEAP GLORY UPON YOUR NAME, STAY AND FACE THE CHAMPIONSHIP ROUND."

If the contestants choose to remain in the arena, the energy field once again raises to prevent outside interference, but there is sufficient time for additional party members to join the fight if they wish. Roll a die once on the table below to determine who the contestants will face in the "Championship Round".

Championship Round:

Die Roll	Champion
1	<i>Malagaunt the Black:</i> Black Knight (WC). Instead of a Greatsword, Malagaunt carries a Longsword and a Tower Shield (STR + d8 damage; +2 <i>Parry</i> /+2 <i>Armor</i> vs. Ranged)
2	<i>Ammoth-Magog the Soul-Feeder:</i> Balrog (WC). Any time Ammoth-Magog inflicts a <i>Wound</i> , he heals one <i>Wound</i> .
3	<i>Orbilax the Undying:</i> Eye Tyrant (WC). Orbilax is <i>Undead</i> (+2 to recover from <i>Shaken</i> ; +2 <i>Toughness</i>)
4	<i>Lord Balemourn of the Thunder Wastes:</i> Skeleton Knight (WC). Lord Balemourn carries a Lance and is mounted on a Nightmare (2d6 damage; double damage when charging; <i>Reach</i> +2)
5	<i>Giliad God-Touched:</i> Gold Golem (WC). Giliad can make a <i>Sonic Blast</i> attack that inflicts 3d6 points of Sonic damage over a Large Blast Template area. If it strikes with a <i>Raise</i> , the targets are deafened for 3 rounds and cannot cast spells.
6	<i>Thorgrim Thrallhammer:</i> Frost Giant (WC). Any combatants slain by Thorgrim are raised as <i>Zombies</i> who serve his bidding.

If the party wins the "Championship Round" they will be rewarded (see *Rewards* below).

Complications & Twists:

- None. The combatants are randomized.

Number of Exits: 4. The other exits remain locked until the "Challenger Round" is defeated.

Rewards: Survivors of the "Championship Round" are rewarded on a sliding scale depending upon how many combatants participated in the battle. The fewer the number of the combatants, the sweeter the reward. The reward is delivered by living statues who carry it out on stone platters.

# of Combatants	Reward
6+	500 gold pieces each and a laurel crown
5	600 gold pieces each, a laurel crown and a <i>Benny</i>
4	750 gold pieces each, a laurel crown, a <i>Benny</i> and <i>Wine of Heroism</i> (+2 to recover from <i>Shaken</i> and ignore 1 point of <i>Wound</i> penalties for 6 rounds)
3	1000 gold piece each, a laurel crown, a <i>Benny</i> , <i>Wine of Heroism</i> and <i>Finbar's Ointment</i> (heal 1 <i>Wound</i> or ingest to cure <i>Poison</i> or <i>Disease</i>)
2	1500 gold pieces each, a laurel crown, a <i>Benny</i> , <i>Wine of Heroism</i> , <i>Finbar's Ointment</i> and a <i>Rudius</i> (wooden sword that inflicts STR + 6d6 points of damage but is destroyed after use)
1	3000 gold pieces, a laurel crown, a <i>Benny</i> , <i>Wine of Heroism</i> , <i>Finbar's Ointment</i> , a <i>Rudius</i> and a <i>Cuirass of the Champion</i> (Armor +4; Immune to Fear)

Throne Room

Listen: You hear nothing.

You have entered a large, airy hall. Two rows of pillars flank a red carpet that spools all the way out to the base of an ornately carved stone throne. You can see the glitter of some gemstones on the throne's armrest. In the shadows of the pillars you see two other exits from the room.

Once a character sits upon the throne, they are immediately bound by steel straps around their arms, legs, waist and neck. The only thing within easy reach is a console of gemstones on the armrest. It is clear to the throne occupant that these gemstones are actually buttons which can be pressed. Pressing a gemstone button causes it to light up.

Each gemstone is keyed to a particular letter based on the name of the stone: D = Diamond; R = Ruby; S = Sapphire; E = Emerald; A = Amethyst; T = Topaz. The throne occupant needs to try and spell words by inputting certain gemstone combinations to activate the throne's effects. *Example:* Pressing the combination *Emerald - Amethyst - Sapphire - Topaz* would spell the word "E-A-S-T" which would unlock the room's exits. If an invalid combination is entered, the stones all go dark and the occupant can attempt to type another word.

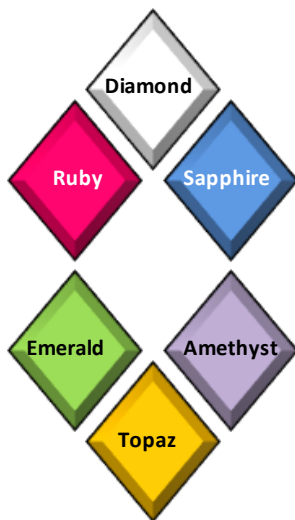

Combination	Effect
EAST, DESTRA, TREAD, STRADE, DARE	The exits unlock but the occupant remains trapped by the throne.
REST, READ, DEAR, RATE, ARE, STEAD, DATE	The bindings on the throne release the occupant
TRADE, STAR, ART, EAR	The secret treasure cache in the back of the throne unlocks (see <i>Rewards</i>)
EAT, SAT, ATE	The throne flips over and deposits the occupant in <i>The Jail</i> .
RED, SAD, TEAR	A blade lashes out and decapitates the occupant. They are instantly killed.
DART, DRAT	Darts fire from the pillars in the room!
SEAR, ARSE, TAR	An explosion is triggered in the room! All targets must make an <i>Agility</i> -2 check or suffer 3d6 points of damage. The throne occupant is spared.
TASE	The throne occupant is shocked for 2d6 points of Electricity damage (+1d6 if they are wearing metal armor)

If the gemstone console is defiled in any way, the throne becomes unusable.

Complications & Twists:

- Some of the gemstones have been switched out and now the codes are all different.

Number of Exits: 3. The other exits remain locked and barred until the correct code is entered into the throne.

Rewards: If the treasure cache on the throne is opened the adventurers find the following: six gems worth 500 gold pieces each (Diamond, Ruby, Sapphire, Emerald, Amethyst, Topaz)

The Harem

Listen: You hear the sound of whispering voices and low laughter.

This room is lavishly decorated with heavy curtains, sheer drapes and thick rugs. The center of the room is recessed and filled with overstuffed cushions. Reclining languidly on these cushions are three shapely women in very brief attire. Their faces are veiled and they appear to be gossiping with one another. When you enter one of them glances over her shoulder in your direction and asks, "Did the Master send you to play with us?"

If any characters in the party have a *Charisma* greater than zero the concubines will make suggestive entreaties toward those individuals. If everyone in the party has a *Charisma* of zero or less, the concubines will hiss and attack. Characters who accept the concubines' advances will run the obvious risks associated with their choices.

Complications & Twists:

- Replace the concubines with *Flesh Golems* (special "pleasure" models that don't have the usual cosmetic defects)

Number of Exits: 2

Rewards: A small chest buried in the cushions of the pillow pit contains a *Potion of Growth* and a vial of oil.

Succubus

Strength: d10	Smarts: d8	Agility: d8	Spirit: d10	Vigor: d8
Pace: 6	Parry: 6	Toughness: 6	Fighting: d8	Charisma: +6
Gear & Weapons: Claws (STR + d4)				
Edges & Powers: <i>Demon</i> (+2 to recover from <i>Shaken</i> ; immune to disease and poison; 1/2 damage from normal weapons); <i>Glamor</i> (can make an opposed <i>Spirit</i> roll against a member of the opposite sex to charm them; effect is indefinite but can only affect one target at a time); <i>Weakness: Cold Iron</i> (takes normal damage from Cold Iron); <i>Life Drain</i> (+2 to hit; target must make an opposed roll (<i>Vigor</i> vs. <i>Succubus' Spirit</i>) or lose one die step of <i>Vigor</i>)				

Gorgon

Strength: d8	Smarts: d8	Agility: d8	Spirit: d8	Vigor: d8
Pace: 6	Parry: 5	Toughness: 6	Fighting: d6	
Gear & Weapons: Bash (STR); Serpent Bite (d4+2)				
Edges & Powers: <i>Petrifying Gaze</i> (make an <i>Agility</i> -4 check or be turned to stone; can blind-fight to avoid making eye contact); <i>Serpent Hair</i> (can attack all adjacent targets; bitten targets must make a <i>Vigor</i> -2 check or become Incapacitated by <i>Fatigue</i>)				

Vampiress (WC)

Strength: d12+3	Smarts: d10	Agility: d8	Spirit: d10	Vigor: d12
Pace: 6	Parry: 7	Toughness: 10	Fighting: d10	
Gear & Weapons: Bash (STR)				
Edges & Powers: <i>Undead</i> (+2 to recover from <i>Shaken</i> ; +2 <i>Toughness</i> ; immune to <i>Wound</i> penalties); <i>Glamor</i> (can make an opposed <i>Smarts</i> roll against a member of the opposite sex to charm them; effect is indefinite but can only affect one target at a time); <i>Improved Frenzy</i> (2 attacks per round); <i>Invulnerability</i> (can only be wounded or killed by their weaknesses); <i>Weakness: Sunlight, Holy Water, Stakes, Holy Symbols</i> ; <i>Sire</i> (targets killed by a vampire become vampire thralls in 1d4 days); <i>Level Headed</i> (act on best of 2 initiative cards); <i>Mist Form</i> (make a <i>Smarts</i> -2 check to turn into a fog)				

Room of Mysterious Pools

Listen: You hear nothing.

Six large pools are spaced evenly in this room. They are filled with different liquids [consult the table below] and each appear to be about 3' deep.

Draw six cards and consult the table below to determine which pools are actually in play. If a result is repeated then that pool is empty. Characters who try to do the "pinky test" by just dipping the tiniest part of their body in the pool will feel a diminished version of the "Soak Effect".

Card	Description	Soak Effect	Imbibe Effect
2	Milky, pink liquid	Removes all dirt, grime, cuts and scratches	Heals all <i>Wounds</i> . You can only gain this effect one time.
3	Clear, fizzing liquid with an incredibly sharp aroma	2d10 points of Acid damage	2d10 points of Acid damage + <i>Vigor</i> -2 check or die
4	Cloudy, gray liquid	Leaves a foul-smelling residue	After 1d4 hours, make a <i>Vigor</i> -2 save or become <i>Anemic</i> .
5	Perfectly clear liquid	Bracingly cold water	Refreshing!
6	Deep red colored liquid with a fruity aroma	You smell like you just bathed in wine. Clothes are stained.	Excellent vintage! Make a <i>Vigor</i> -2 check or become instantly intoxicated for 1d6 hours.
7	Hot steam rises from the surface of this pool	Relaxes stiff muscles	Tastes like hot water
8	A shimmering pool of iridescent liquid	Your body glows with soft light for the next 1d6 hours	Gain a one step increase to your <i>Spirit</i> die for 1d6 hours.
9	Swirling mixture of light and dark green liquid	You feel drowsy. Make a <i>Spirit</i> check or fall asleep for 2d6 hours.	Tastes fruity! You immediately fall asleep for 2d6 hours.
10	Perfectly clear liquid	No effect	Become mute for 1d6 hours. Spellcasting is impossible.
J	A nearly empty pool with a trace of clear liquid remaining at the bottom	No effect	Become ravenously thirsty. Compelled to drink from all the other pools.
Q	Clear liquid with gold fish swimming in it	Fish will nibble dead skin from your body	Tastes like a fish bowl
K	Thick white vapor billows from this pool	Freezing! Suffer 2d6 points of Cold damage	Gah! Cold! Suffer 2d6 points of Cold damage but become immune to the effects of cold for the next 1d6 hours.
A	In the pool's reflection you see a vision of your home	The image is spoiled	Water that is flavored to remind you of your favorite drink.
Joker	Perfectly clear liquid	A <i>Water Elemental</i> attacks you!	A <i>Water Elemental</i> attacks you!

Complications & Twists:

- None. The pools are randomly determined each time you visit this room. Feel free to add additional pools of your own creation.

Number of Exits: 4

Rewards: None

The Chessboard

Listen: You hear nothing.

The floor of this large room is patterned in black and white chequy. Arrayed on the far side are two ranks of man-sized statues carved from black onyx. Most are carved in the shape of spear-carrying footmen but the figures in the back row have more elaborate forms: Kings & Queens, Knights & Priests and Earth Elementals.

Note: This encounter requires a working knowledge of Chess. If you have no idea how Chess is played (shame on you) discard this encounter and draw another one.

As soon as a character steps on one of the white-lettered chessboard squares (see below) a white force field surrounds them and prevents them from moving. A disembodied voice informs them what their role will be (*Example:* "You are the Queen!") Once all of the party members have selected a role the game will begin.

The black side moves first, making legal chess moves. Once every piece on black goes, the players will be permitted one by one to make a move. The force field surrounding them will dissipate and they are free to move on any squares they wish. If they attempt to move into a square that would be illegal based on their role (for example: if a Rook tries to move diagonally), then the square the character is standing on will glow red and they will immediately suffer one *Wound*. The force field traps the character once again and their move is finished until next turn.

If a character ends their move on a square occupied by a black piece, a one on one battle ensues between the player and the chess piece. It is a fight to the death.

Play continues in this fashion until the Black King is slain. Once this is done, the remaining black chess pieces collapse into rubble and the force fields trapping the players disappear. The door at the far end of the room audibly unlocks.

Complications & Twists:

- None

Number of Exits: 2. The other exit will not unlock until the King has been defeated.

Rewards: If the party goes to the extra effort of eliminating all the black chess pieces, they will all receive 1 extra *Experience Point*.

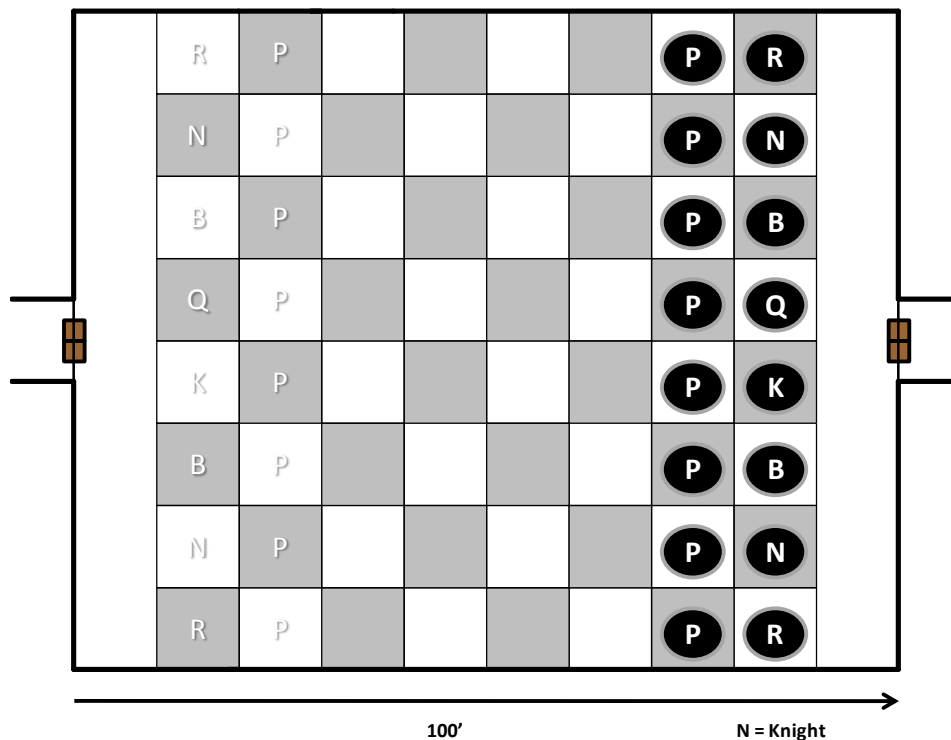

Chess Piece	Modifier
<i>Pawn</i>	No modifier
<i>Knight</i>	<i>Fighting: d10; Parry: 8</i>
<i>Bishop</i>	<i>Spellcasting: d12; Arcane Bolt (2d6 damage; 12 square range)</i>
<i>Rook</i>	<i>Strength: d12; Vigor: d12; Toughness: 8</i>
<i>King</i>	<i>Wild Card</i>
<i>Queen</i>	<i>Fighting: d12; Parry: 9; Strength: 12; Wild Card</i>

Living Statues (16)				
Strength: d10	Smarts: d4	Agility: d6	Spirit: d8	Vigor: d8
Pace: 4	Parry: 5	Toughness: 10 (6)	Fighting: d6	
Gear & Weapons: Bash (STR)				
Edges & Powers: <i>Armor +4; Construct (+2 to recover from Shaken; immune to called shots, disease and poison; 1/2 damage from piercing); cannot Sprint</i>				

The Zoo

Listen: You hear a rather strange cacophony of animal sounds (i.e. roars, growls, hoots, etc.)

You enter a spacious open air courtyard that is at least 100' by 100' in size. Six large cages occupy a manicured lawn. They contain an assortment of strange beasts. Each cage has a small placard attached to it which you cannot read from where you are standing. You can, however, clearly see a sign driven into the grass that says in several languages, "DO NOT FEED THE ANIMALS".

One of the cages is occupied by an *Adventurer* who will gladly assist the party if he is freed. Roll a d10 for each of the 5 remaining cages to determine what sort creature is kept there. If you roll the same result more than once, consider that particular cage to be empty. The placard on each cage names the beast it contains and includes some mundane facts about its preferred habitat, dietary habits and reproductive behaviors.

Die Roll (d10)	Creature	Description
1	<i>Unicorn</i>	The Unicorn, <i>Equum Benedixit</i> , is a distant cousin of the common horse that can often be found sipping dew drops in some rainbow-lit glade.
2	<i>Manticore</i>	The <i>Homo Leonis</i> prefers to hunt in places such as canyons where it can use a high perch to rain tail spikes down upon its prey.
3	<i>Owl Bear</i>	One night an exceptionally inebriated owl came across a very broad-minded bear. The product of this union was <i>Ursa Noctuae</i> , the dreaded bear-owl.
4	<i>Nightmare</i>	Contrary to popular opinion, <i>Equum Malis</i> is not actually related to horse-kind at all. It is in fact a proper demon in equine form.
5	<i>Arachnaur</i>	The species <i>Homo Aranea</i> is the improbable crossing of a human man and a spider. Various primitive cultures worship these abominations as gods.
6	<i>Demonic Ape</i>	<i>Simia Diabolus</i> is a species of ape that has, as a result of unspeakable acts perpetrated by succubi and incubi, obtained a certain measure of demonic heritage.
7	<i>Intellect Devourer</i>	The <i>Cogitatio Comedentis</i> is one of the only animals known to sustain itself purely on mental energy. Researchers have spent lifetimes attempting to understand this process but have always seemed to forget what little they manage to learn.
8	<i>Hellcat</i>	This is no ordinary <i>Felis Domesticus</i> .
9	<i>Umber Hulk</i>	An enthusiastically large insect, <i>Bruta Brunnea</i> is happiest when it can burrow in soft earth. It prefers to lay its delectable eggs in the carcass of a fresh kill.
10	<i>Rust Monster</i>	In prehistoric times the <i>Aerugo Monstrum</i> could grow as large as an olyphant but a lack of readily consumable surface metals has precipitated a decline not only in their stature, but of their population as well.
--	<i>Adventurer</i>	A common example of <i>Homo Periculum</i> , noted for its boorish behavior and avarice. These creatures feed primarily on a metaphysical substance called "Experience Points".

If any object is thrown or fired into one of the cages, it is annihilated by a static-electric barrier and the cage is unlocked, permitting the creature contained within to roam free (and attack, of course).

Climbing Out:

Characters who wish to scale the 50' high walls can climb out of Castle Farkinwald. They'll find themselves somewhere within the grounds of the castle and will need to scale another 100' high wall to truly break free (since all of the gateways are underground). It is impossible to gain access to any other rooms of the castle by climbing

out of this room -- from the outside the buildings of the castle are just windowless, door-less stone slabs for as far as the eye can see.

Complications & Twists:

- Replace the *Adventurer* with a *Doppelganger* who is pretending to be an *Adventurer*. If freed he will wait for an ideal time to betray the party.

Number of Exits: 4

Rewards: None.

The Golem Factory

Listen: You hear the sounds of rhythmic metallic clanking and whooshing air.

Against the far wall of this room you see some sort of bizarre contraption that's about 50' long and 20' tall. It is a complex mass of brass pipes, tubes and valves that looks like nothing you've ever seen. The device is vibrating and shooting jets of steam into the air. Standing in vats located at the base of the machine you see an Iron Golem, Clay Golem and Stone Golem. As you enter, the golems stir and begin moving toward you with arms outstretched.

The machine will continue to manufacture a new golem (Iron, Clay or Stone) every 10 rounds until it is disabled. There is a lever in the center of the machine that can be pulled to cease its operation. Alternatively, if the machine sustains a *Wound* (or is *Shaken* twice) it will break down; it has a *Toughness* rating of 12 and is immune to fire damage.

Complications & Twists:

- Replace the golems with a *Gold Golem* who is performing some kind of maintenance on the machine.

Number of Exits: 3

Rewards: None

Iron Golem				
Strength: d12+3	Smarts: d4	Agility: d6	Spirit: d8	Vigor: d12+1
Pace: 6	Parry: 6	Toughness: 15 (9)	Fighting: d10	
Gear & Weapons: Bash (STR+d6)				
Edges & Powers: <i>Armor</i> +6; <i>Construct</i> (+2 to recover from <i>Shaken</i> ; immune to called shots, disease and poison; 1/2 damage from piercing); cannot <i>Sprint</i> ; <i>Improved Arcane Resistance</i> (+4 <i>Toughness</i> vs. Magic); <i>Improved Sweep</i> (can make <i>Sweep</i> attacks with no penalty)				

Clay Golem				
Strength: d12+4	Smarts: d4	Agility: d4	Spirit: d12	Vigor: d10
Pace: 6	Parry: 6	Toughness: 14(9)	Fighting: d8	
Gear & Weapons: Bash (STR)				
Edges & Powers: <i>Improved Arcane Resistance</i> (+4 <i>Toughness</i> vs. Magic); <i>Construct</i> (+2 to recover from <i>Shaken</i> ; immune to called shots, disease and poison; 1/2 damage from piercing); cannot <i>Sprint</i> ; <i>Cursed Wounds</i> (any <i>Wounds</i> inflicted by a Clay Golem can only be healed by magic); <i>Armor</i> +5				

Stone Golem				
Strength: d12+2	Smarts: d6	Agility: d6	Spirit: d8	Vigor: d12
Pace: 5	Parry: 7	Toughness: 13(9)	Fighting: d10	
Gear & Weapons: Bash (STR+d6)				
Edges & Powers: <i>Armor</i> +4; <i>Construct</i> (+2 to recover from <i>Shaken</i> ; immune to called shots, disease and poison; 1/2 damage from piercing); cannot <i>Sprint</i> ; <i>Improved Arcane Resistance</i> (+4 <i>Toughness</i> vs. Magic)				

Hall of Mirrors

Listen: You hear nothing.

The walls of this room are entirely covered by mirrors. Floating near the center of the room is an abominable monstrosity: a chitinous orb with a large central eye, slavering maw and eight small eyestalks waving on its dorsal side. It roars eagerly as its eyestalks begin to glow.

If any of the Eye Tyrant's eye beams miss their intended target, they will deflect off the mirrored wall at a congruent angle and could potentially hit a different target on the rebound. Beams will only deflect one time before they lose their potency.

Complications & Twists:

- Replace the Eye Tyrant with Simulacra of the party members. These copies are statistically identical to the party members in every way except that they can only be killed by shattering the mirrors.

Number of Exits: 3. One of the exits is hidden behind a mirror.

Rewards: None

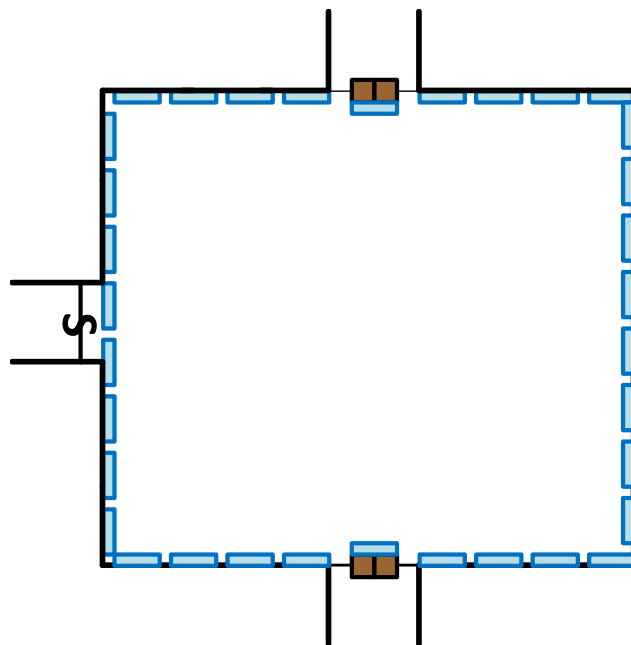

Eye Tyrant (WC)				
Strength: d6	Smarts: d12	Agility: d6	Spirit: d10	Vigor: d8
Pace: 6 (Fly)	Parry: 5	Toughness: 9 (6)	Fighting: d6	
Gear & Weapons: Bite (STR + d4)				
Edges & Powers: <i>Eye Beams</i> (12 square range; target must make an <i>Agility</i> -2 check to dodge a beam; see below for beam effects); <i>Anti-Magic Gaze</i> (generates a cone-shaped anti-magic field from its center eye; all magic and magic items are suppressed in this field); <i>Level Headed</i> (act on best of 2 initiative cards); <i>Quick</i> (redraw any initiative card that is equal to or less than 5); <i>Fly</i> (Pace 6); <i>Armor</i> +3				

The Slammer

Listen: You hear nothing.

The walls of this room are crusted with dried gore. There appears to be one other exit from this room directly across from where you're standing.

A cursory inspection of the room reveals that the entire floor is a pressure plate. If a character carefully inspects the room before entering (*Notice -4*) they will be able to estimate the pressure plate's weight threshold.

As soon as 150 lbs. of weight is placed on the floor of this room a crushing wall trap is activated, instantly killing anyone who stands in the room. After activation, the trap will reset in 3 rounds, giving people time to quickly move through the room.

Complications & Twists:

- None

Number of Exits: 2

Rewards: None

The Crypt

Listen: You hear nothing.

The floor of this room is covered with densely packed dirt. A baleful looking statue stands against one wall depicting a robed corpse with long, sharp nails. Six stone sarcophagi are arranged in ordered rows, all of them sealed by their heavy stone lids.

The statue is actually a *petrified* Grave Guardian set to watch over this crypt.

The stone slabs sealing the sarcophagi require a *Strength -2* check to remove. Inside each sarcophagus is a richly dressed mummified body. You can see that most have been buried with some valuable personal possessions.

If any of the mummies are disturbed, the *Grave Guardian* will animate after 1d4+1 rounds. It will pursue the party to the death.

Complications & Twists:

- When disturbed the *Mummies* in the sarcophagi animate.
- If the mummies are disturbed, 2d8 *Skeletons* come bursting out of the floor.
- Replace one of the mummies with a *Skeleton Knight*.

Number of Exits: 2

Rewards: For each sarcophagus that is looted, consult the table below:

Die Roll	Treasure
1	<i>Magic Weapon:</i> the sarcophagus contains a random +1 magic weapon (+1 to <i>Fighting</i> rolls and damage)
2	<i>Magic Armor:</i> a random piece of +1 magical armor
3	<i>Scrolls:</i> 1d4 random spell scrolls
4	<i>Miscellaneous Item:</i> a random miscellaneous magic item
5	<i>Wand:</i> a random magical wand with 2d20 charges
6	<i>Magic Clothing:</i> a random piece of magical clothing
7-8	Nothing

Grave Guardian				
Strength: d12	Smarts: d6	Agility: d6	Spirit: d10	Vigor: d12
Pace: 6	Parry: 7	Toughness: 10	Fighting: d10	Guts: -2
Gear & Weapons: Claws (STR + d6)				
Edges & Powers: <i>Undead</i> (+2 to recover from <i>Shaken</i> ; +2 <i>Toughness</i>); <i>Fast Regeneration</i> (make a <i>Vigor</i> check each round to heal 1 <i>Wound</i> ; Cold Iron prevents this); <i>Weakness: Cold Iron</i> (damaged normally by Cold Iron); <i>Arcane Resistance</i> (+2 <i>Toughness</i> vs. Magic); <i>Fearsome Appearance</i> (when someone sees a Grave Guardian for the first time they must succeed a <i>Guts -2</i> check or become <i>Shaken</i>)				
Spells (15 Power Points): <i>Armor, Burrow, Detect Arcana, Environmental Protection, Fear, Obscure</i>				

Summoning Chamber

Listen: A deep gravelly voice says, "COME IN, MORTAL".

The greater portion of this room is taken up by a massive summoning circle inscribed in the floor. Lines of red powder trace a pentagram and ever-burning candles lights the points of the star. Contained within this arcane geometry is a huge, red-skinned demon with hooved feet, powerful looking claws and ram's horns. The demon addresses you all saying, "HEAR ME, MORTALS! THAT ABOMINABLE WIZARD TRAPPED ME HERE AGAINST MY WISHES. I WOULD DEARLY WISH TO PAY HIM BACK WITH HIS OWN COIN. WHOSOEVER OF YOU FREES ME SHALL BE GRANTED A SINGLE BOON. WHAT DOST THOU SAY?"

The demon will grant a wish as promised but the wish must be carefully phrased; his gifts are often tainted in some way. If the wisher asks for something the demon cannot give, he will fairly warn them and give the wisher a chance to amend their request. Once he has discharged his boon, the demon will teleport away in a cloud of brimstone.

Character wishes for....	The Demon will....
Riches	Transfer all gold from every other character in the party to the wisher's backpack.
A Kingdom	Give the wisher a impressive looking gem-encrusted gold crown that is actually fake.
More Wishes	Refuse. Only a true God can do this.
Release from the Dungeon	Teleport the entire party outside of Farkinwald's Castle... 100 feet in the air.
Immortality	Refuse. Only a true God can do this.
Powerful Magic Items	Give the wisher a random <i>Miscellaneous Magic Item</i>
Statistical Increases	Increase the statistic of the wisher's choice by one die type while reducing another.
Magical Power	Restore your full complement of Power Points
Martial Power	Permanently enchant your primary weapon with <i>Balefire</i> . Targets struck by this weapon have a 1 in 6 chance of combusting.
Teleport to another location in the Castle	Refuse. Farkinwald's magical wards prevent this.
The death of a specific foe	Agree to assist the wisher if and when they do battle against this foe.
Experience	Magically touch the wisher's mind, showing them an array of strange and horrible things. The wisher gains 2 Experience Points.
Healing	Magically heals 1 <i>Wound</i>
Curse/Disease Removal	Magically removes the disease or curse
Resurrection of a comrade	Resurrect your comrade with 3 <i>Wounds</i> and lay claim to their mortal soul. The next time your comrade dies, it will be permanent.

Complications & Twists:

- Replace the Demon with an Angel. The Angel will heal the party's wounds if freed but nothing more.
- Replace the Demon with a Greater Elemental. The Elemental is incapable of bargaining and will go on a random killing spree if released.
- The summoning circle is empty. The first character to step into it becomes trapped in a bubble of force and is eventually moved to *The Jail*.

Number of Exits: 3

Rewards: None, beyond whatever gifts the demon may give you.

The Drain

Listen: You hear the sound of cascading water.

The entire floor of this room is funnel-shaped, terminating at a 3' wide hole in the center of the room. Four gargoyle statues are arranged in the corners of the room; each belches forth a torrent of water that makes the sides of the funnel slick with wetness and mildew growth.

Characters who fall or jump down the drain sustain 2d6 points of falling damage and end up in a hallway leading to the next room. A storm drain in the hallway carries off excess water. If any enterprising adventurers want to secure a rope to make the passage smoother, they will need 60' of rope to eliminate the possibility of incurring any falling damage. Once the party makes it through the drain their rope will either be pulled up or cut by mysterious hands.

Complications & Twists:

- One or more of the *Gargoyles* animate and attack.
- The *Gargoyles* have an *Acid Breath* attack that inflicts 2d10 points of Acid damage.

Number of Exits: 2. This is a one-way room. Once you proceed down the drain you will be unable to climb back up on account of the onrushing water and slick stones.

Rewards: None

Gargoyle (4)				
Strength: d10	Smarts: d4	Agility: d8	Spirit: d6	Vigor: d10
Pace: 4(10)	Parry: 6	Toughness: 9(7)	Fighting: d10	
Gear & Weapons: Claws (STR + d4)				
Edges & Powers: <i>Armor +2; Camouflage (+2 Stealth when in rocky terrain); Fly (can fly at a Pace of 10)</i>				

Courtyard of Stampedes

Listen: You hear hooves clicking on stone and the lowing of cattle.

This expansive courtyard is entirely filled by a herd of bison. As your unfamiliar smell fills their nostrils, the animals become spooked and begin stampeding toward you!

Why not? Farkinwald has to keep his pets fed somehow right? What better way than to raise your own cattle?

The bison will continue stampeding until they reach an impassable obstacle. They will bash through any doors that get in their way. In their agitated state, the bison will plunge suicidally into any danger.

If any party members attempt to impede the bison they will gored and trampled. By pressing themselves up against a wall, they suffer only half damage from the bison attacks.

Climbing Out:

Characters who wish to scale the 50' high walls can climb out of Castle Farkinwald. They'll find themselves somewhere within the grounds of the castle and will need to scale another 100' high wall to truly break free (since all of the gateways are underground). It is impossible to gain access to any other rooms of the castle by climbing out of this room -- from the outside the buildings of the castle are just windowless, door-less stone slabs for as far as the eye can see.

Number of Exits: 2

Rewards: As many buffalo steaks and hides as you can carry.

Bison (25)				
Strength: d12+2	Smarts: d4(A)	Agility: d6	Spirit: d8	Vigor: d12
Pace: 7	Parry: 4	Toughness: 10	Fighting: d4	
Gear & Weapons: Bash (STR)				
Edges & Powers: Gore (if the Bison moves its full Pace before attacking it can inflict +4 Damage)				

The Storage Room

Listen: You hear nothing.

This storage area is packed floor to ceiling with barrels and wooden crates. There's scarcely any room inside to stand. Strange lettering is stenciled on a number of crates. Who knows what could be buried in here?

Buried behind all of the crates, against the far wall, is a crawlspace that leads out of this room. Revealing the crawlspace takes a lot of manpower. Have the strongest member of the party make a *Strength* check, adding +2 for each party member that assists. Subtract this result from 50 to determine how many rounds it will take to clear a path to the exit. Make a *Wandering Monster* check every 10 rounds until something shows up.

Each crate weighs about 75 lbs. and has its contents printed on it in Dwarvish. Given enough time, just about any common item can be found in this store room. Searching for a particular item requires a *Notice* check. Subtract the result from 20 to determine how many rounds it takes to find the item. Make a *Wandering Monster* check every 10 rounds until something shows up.

Complications & Twists:

- A number of crates contain volatile explosives and have warnings stenciled on them in the Goblin tongue. Rough handling of these crates causes them to explode for 3d6 points of damage over a Large Blast Template area (causing a chain reaction in all likelihood)
- The crawlspace is rigged with a *Spike Trap* that impales a target for 2d6 points of damage.

Number of Exits: 2. The only other exit is a crawlspace that is revealed if all the crates are moved out of the way.

Rewards: Virtually any common item can be found here.

The Barracks

Listen: You hear snoring.

A number of bunk beds line the walls of this room. You can see a detachment of humanoid guards snoozing with weapons near at hand.

It is possible to sneak through this room without waking the guards, but there is an *Alarm Trap* set on the threshold of each door. A *Notice -2* check is required to detect the trap and a *Lockpicking -2* check is required to disarm it.

Die Roll (d6)	Guard Type
1	1d6 + 2 Hobgoblins
2	2d8 + 2 Kobolds
3	1d6 + 2 Evil Men
4	1d4 Ogres
5	1d4 Minotaurs
6	Guards are illusory; the bunkbeds are actually <i>Mimics</i> .

Complications & Twists:

- None. Guard type changes each time.

Number of Exits: 3

Rewards: Each guard carries 1d6+1 gold pieces (except for the illusory ones, obviously)

Guard Room

Listen: You hear muttering voices.

A detachment of guards in Farkinwald livery is pulling a shift here. They had been in the middle of a bull session when you showed up but snatch up their weapons immediately and command you to halt.

The guards have been given strict instructions to deny all intruders and to take prisoners alive if possible. Prisoners are escorted to *The Jail*.

Die Roll (d6)	Guard Type
1	1d6 + 2 Hobgoblins
2	2d8 + 2 Kobolds
3	1d6 + 2 Evil Men
4	1d4 Ogres
5	1d4 Minotaurs
6	1d2 Giants

Complications & Twists:

- None. Guard type is different each time

Number of Exits: 4

Rewards: Each guard carries 1d6+1 gold pieces

The Runic Gate

Listen: You hear nothing.

The only feature of note in this room is a large runic arch that occupies the far wall. A field of shimmering energy fills the archway. Unusual inscriptions are carved along the entire length of the arch.

It is possible to glean something of the gate's function by translating the carved inscriptions. If a character with an appropriate *Knowledge* skill makes a successful skill check at -2 they can figure out what kind of gate they're dealing with.

Die Roll	Effect
1	<i>Invisibility:</i> Passing through the energy field renders you invisible and inaudible for 1d6 hours
2	<i>Electricity:</i> You are zapped for 3d6 points of Electricity damage
3	<i>Diminution:</i> You shrink by one size category for 1d6 hours
4	<i>One Way Gate:</i> Once the gate is passed it is impossible to backtrack
5	<i>Prismatic:</i> You suffer 1d6 points of Fire, Electricity, Acid and Cold damage simultaneously
6	<i>Magebane:</i> You suffer 1 point of magic damage for every Power Point you currently have
7	<i>Enervation:</i> You gain 1 <i>Fatigue</i> level
8	<i>Random:</i> The gate effect changes every time someone goes through it

Complications & Twists:

- None. The gate effect should be different every time someone explores this room.

Number of Exits: 2. Under most circumstances the arch can be passed multiple times, but its effects are cumulative.

Rewards: None

The Museum

Listen: You hear nothing.

This large room contains six marble pedestals lit by magical spotlights. Upon each pedestal rests an old looking relic of some kind. Placards attached to the front of each pedestal appear to describe the artifacts in more detail. Two imposing iron golems stand watch at the back of the room, arms folded across their chests.

Draw cards to determine what relics are on display. If you draw the same card twice, consider that pedestal to be empty. If anyone acts as if they are going to touch one of the relics, the Iron Golems boom out a warning, "DO NOT TOUCH THE ARTIFACTS!" Characters who refuse this advise will be attacked by the golems.

Someone with a *Knowledge* of ancient history or a talent for *Appraisal* can attempt to discern the market value of the relics.

Card	Item
2	<i>The Bronze Helm of Ardin:</i> A stylish war-helm once worn by the legendary Myrmidons of Ardin. (800 gold pieces)
3	<i>Bust of Emperor Traxilant IV:</i> An amazingly well-preserved marble bust of the Emperor Traxilant. (7,500 gold pieces)
4	<i>Sabinian Necklace:</i> A piece of ladies jewelry from the Isle of Sabine. (6,000 gold pieces)
5	<i>Urn of Arqash:</i> Funerary urn containing the ashes of a bona fide Arqashian noble. (3,000 gold pieces)
6	<i>Flute of Porthca:</i> A musical instrument from an island of shepherds. (500 gold pieces)
7	<i>Eritian Drinking Goblet:</i> Ornate drinking vessel from an Eritian noble. (250 gold pieces)
8	<i>Fragments of Denshen Pottery:</i> Shards of pottery from the ancient Denshen people, known for their porcelain. (300 gold pieces)
9	<i>Sacrificial Dagger of the Lemnae:</i> Dagger used in human sacrifice rituals by the beast-loving Lemnae (2,500 gold pieces)
10	<i>Arlechian Doubloons:</i> Gold coins from the now destroyed City-State of Arlech. (1,000 gold pieces)
J	<i>The Girdle of Thysdrius:</i> Belt worn by the mythic hero Thysdrius. (5,000 gold pieces)
Q	<i>Tablets of Nainarv:</i> Crude stone tablets written in the language of a dead race. (500 gold pieces)
K	<i>Amulet of the Cinlu:</i> An elaborate necklace worn by the Priests of the Cinlu, an ancient jungle culture from the other side of the world. (7,500 gold pieces)
A	<i>The Doom of Hieronymous:</i> The wearer of the <i>Doom</i> gains a +2 bonus to <i>Charisma</i> and gains 25% more gold when treasure is handed out but takes a -1 penalty to all skill and trait checks. (10,000 gold pieces)
Joker	<i>An Artifact!</i> Consult Appendix B

Each pedestal is protected by a trap (randomly determined on the table below). The mechanism controlling the trap can be found with a *Notice* -2 check and disarmed with a *Lockpicking* -2 check.

Die Roll (d4)	Trap
1	<i>Targeting Dust:</i> All targets in a Small Blast Template radius are coating with sparkling dust that makes them easier to hit. Ranged attackers gain a +1 bonus when attacking someone covered in targeting dust.
2	<i>Shocking Trap:</i> Target is zapped by an arcing bolt of electricity that inflicts 2d6 points of damage (+1d6 if the target is wearing metal armor)
3	<i>Gas Trap:</i> A cloud of poison gas fills a Large Blast Template area. All targets in the area of effect must make a <i>Vigor</i> -2 check or become <i>Incapacitated</i> .
4	<i>Stun Ray:</i> Make an <i>Agility</i> -2 check or be struck by a beam of red energy that causes you to be <i>Paralyzed</i> for 3 rounds.

Complications & Twists:

- None. The museum objects and traps are randomized every time this room is explored.

Number of Exits: 3

Rewards: Any museum exhibits that are taken will have value to a collector of antiquities. Their auction price is listed but most trading houses will only pay half at most.

Iron Golems (2)				
Strength: d12+3	Smarts: d4	Agility: d6	Spirit: d8	Vigor: d12+1
Pace: 6	Parry: 6	Toughness: 15 (9)	Fighting: d10	
Gear & Weapons: Bash (STR+d6)				
Edges & Powers: <i>Armor</i> +6; <i>Construct</i> (+2 to recover from <i>Shaken</i> ; immune to called shots, disease and poison; 1/2 damage from piercing); cannot <i>Sprint</i> ; <i>Improved Arcane Resistance</i> (+4 <i>Toughness</i> vs. Magic); <i>Improved Sweep</i> (can make <i>Sweep</i> attacks with no penalty)				

The Banquet

Listen: You hear nothing.

A large table occupies the center of this room. Upon it is spread a white table cloth with some excellent looking place settings. Apart from the room's two other exits you see a dumbwaiter off in the corner. A variety of monsters are seated at the table [refer to the Dinner Guest List below] and at the head sits a skeletal figure in moldering robes that look to have been fine at one time. The skeletal host stands to greet you as you enter, "Oh excellent, the guests of honor have arrived! Please, seat yourselves at once so that the feast can begin!"

An insane Lich named Noldrath has been hosting dinner parties in Castle Farkinwald for centuries now. Every creature in Farkinwald's employ hopes to receive a coveted invite.

Three other dinner guest are already seated and waiting for the party when they arrive. If you roll a duplicate result then that spot at the table is empty.

Die Roll (d8)	Dinner Guest
1	<i>Eye Tyrant</i>
2	<i>Hobgoblin</i>
3	<i>Vampire</i>
4	<i>Succubus</i>
5	<i>Mind Flayer</i>
6	<i>Cenobite</i>
7	<i>Cambion</i>
8	<i>Arachnaur</i>

A phantasmal waiter will approach each dinner guest and present them with a menu. You can find a player friendly version of the dinner menu in Appendix D. The guests are asked to order something from each course.

The Menu		
Appetizer	Illithid Ceviche	Hmm... Chewy. You gain limited ESP for the next 1d6 hours. You can make an opposed <i>Spirit</i> check to hear the surface thoughts of any sentient creature.
	Charcuterie Plate	You think some of the sausages are still alive. Make a <i>Guts</i> -2 check to choke this down without being ill.
	Halfling Pate with Toast Points	Simply magnificent! Who knew Halfling livers tasted so good?
Salad Course	Spring Greens with Bloodgood's Special Dressing	The probably should have run the dressing through a strainer or something. You find unidentifiable hairs. Make a <i>Guts</i> check or become ill.
	Tossed Shambling Mound with Umber Hulk Roe	Mmm, nourishing! You heal 1 <i>Wound</i> .
	Githyanki Soulaw	Needs mayo. You keep hearing strange whispers in your head after you eat this. Suffer a one step decrease to your <i>Spirit</i> until you get a chance to sleep it off.
Main Course	Tablesides Roasted Human <i>au Poivre</i>	Ew, the head's still on it! If you are human you find this revolting. Make a <i>Guts</i> -4 check to eat this without having a crisis of conscience.
	Stuffed Rust Monster Nymphs	You'll want to keep the utensils away from this one.

		Surprisingly good! Tastes like crab.
	Wyvern Chops in Fireberry Sauce	Cripplingly spicy, but hearty nonetheless. You gain a +4 bonus to resist the effects of <i>Poison</i> and <i>Disease</i> until you go to sleep.
	Myconid Truffle Fettuccini	Oh whoa! You start experiencing wild hallucinations until you go to sleep. Suffer a -1 penalty to all rolls.
Dessert	Black Pudding	Don't worry about it, it's just a black licorice pudding.
	Candied Mandrake with Mint Compote	Your breath is now minty fresh! Gain +1 <i>Charisma</i> until you go to sleep.
	Brandy Poached Pixie Brains	Ugh, these are sickeningly sweet! Make a <i>Guts</i> -2 check to avoid throwing up.
Beverage	Asmodean Whiskey	Every sip is like drinking a thunderstorm. The cares of the world seem to wash away. Gain +2 <i>Toughness</i> until you go to sleep.
	Prismatic Wine	This mage-blended wine changes flavor as you drink it. It's pleasing to the palate. Make a <i>Vigor</i> check or become drunk for 1d4 hours. While drunk you must pass a <i>Vigor</i> check with each course to avoid throwing up.
	Undermountain Ale	Strong stuff! Brewed by psychotic dwarves. Make a <i>Vigor</i> -4 check or become seriously drunk for the next 1d6 hours. While drunk you must pass a <i>Vigor</i> check with each course to avoid throwing up.

During each course Noldrath expects everyone to exchange banalities. If people aren't eating, drinking and socializing the Lich will become irate. Anyone can choose to skip a single course but if they skip more than one, or become ill, they will incur their host's wrath. As long as the party remains well-behaved nothing bad will happen to them.

Dumbwaiter leads to *The Kitchen*, but only characters who are 1' in size can fit in it.

At any point the party can decide they've had enough and just attack Noldrath and his guests.

Complications & Twists:

- Change up the menu

Number of Exits: 3

Rewards: If anyone manages to make it all the way through every course, they are presented with an after dinner mint and gain 1 Experience Point.

Noldrath, Lich (WC)				
Strength: d10	Smarts: d12+2	Agility: d6	Spirit: d10	Vigor: d10
Pace: 6	Parry: 6	Toughness: 15(9)	Fighting: d8	Spellcasting: d12
Gear & Weapons: None				
Edges & Powers: <i>Magical Armor</i> +6; <i>Death Touch</i> (+2 to hit; each <i>Raise</i> inflicts 1 <i>Wound</i>); <i>Undead</i> (+2 <i>Toughness</i> ; +2 to recover from <i>Shaken</i> ; Immune to Called Shots; ignore <i>Wound</i> penalties); <i>Zombie Master</i> (any <i>Zombies</i> created by the Lich are permanent)				
Spells (50 Power Points): <i>Bolt</i> (2PP; 3d6 damage), <i>Blast</i> (6PP; 3d6 damage L.B.T.), <i>Puppet</i> (4PP), <i>Zombie</i> (3PP), <i>Dispel</i> (3PP), <i>Fly</i> (6PP; Pace 12), <i>Teleport</i> (3PP)				

Sphere of Death

Listen: You hear nothing.

This room is completely sphere shaped. At its center sits an ominous looking black orb that's about 5' in diameter. It seems to suck in all light.

The sphere is naturally attracted to the strongest life-force in the room. The character with the highest *Spirit* trait becomes the sphere's target. Each round the sphere will fly with a *Pace* of 3 in the direction of its target, disregarding all obstacles in its path. The sphere will not pursue anyone outside of this room.

Since the floor and walls of this room are curved characters must make an *Agility* check every time they move to maintain their balance. If characters try to move along the edges of the room, where the curve is steepest, they suffer a -2 penalty to their *Agility* check. Failing this check causes the character to fall prone and slide 2 squares toward the center of the room.

Touching the Sphere...

Is a really bad idea. Any object that comes into contact with the sphere is immediately annihilated. If a living being touches the sphere they must make a *Vigor* -8 check or be disintegrated. Those who pass this roll still sustain 3d10 points of damage.

Complications & Twists:

- Instead of annihilating all matter, the sphere is full of necrotizing energy that turns the living into undead.
- Instead of annihilating all matter, the sphere drains anything it touches of all emotion. Anyone touched by the sphere turns completely pale and their hair turns gray. They suffer a -2 *Charisma* penalty and become immune to *Fear*, but they also lose to capacity to care about anything.

Number of Exits: 2

Rewards: None

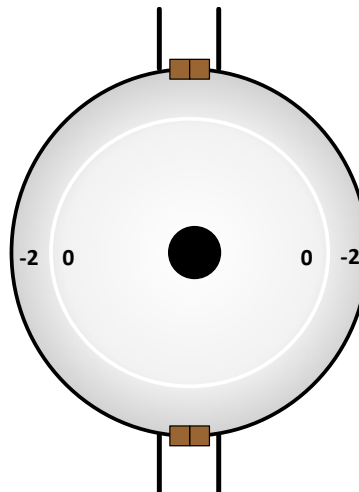

The Birdcage

Listen: You hear nothing but detect the aroma of strong acid.

This room is built like a shaft. The ceiling rises some 50' or 60' above you and the floor below you is filled with sizzling acid. Two crystalline cages hang on opposite sides of the room, one near where you're standing and the other above the room's only other exit. They are attached to one another by some kind of pulley system on the ceiling.

As soon as anyone steps into one of the cages their weight causes it to descend toward the acid below. The cages move at 5' per round. The pulley cables are long enough to immerse the cage occupant in the acid. The cage itself is immune to corrosion.

If anyone lands in the acid they sustain 2d10 points of damage per round.

If the party manages to put equal weight in both cages they can keep them neutrally balanced.

Climbing on the pulley cables requires a two *Climb* checks to reach the ceiling and another *Climb* check to traverse from pulley to pulley. Sliding down a cable requires no check.

Any attempt to leap from one cage to the other requires both a *Strength* -2 check (to leap the intervening distance) and an *Agility* -2 check (to catch the other cage)

Complications & Twists:

- None

Number of Exits: 2

Rewards: None

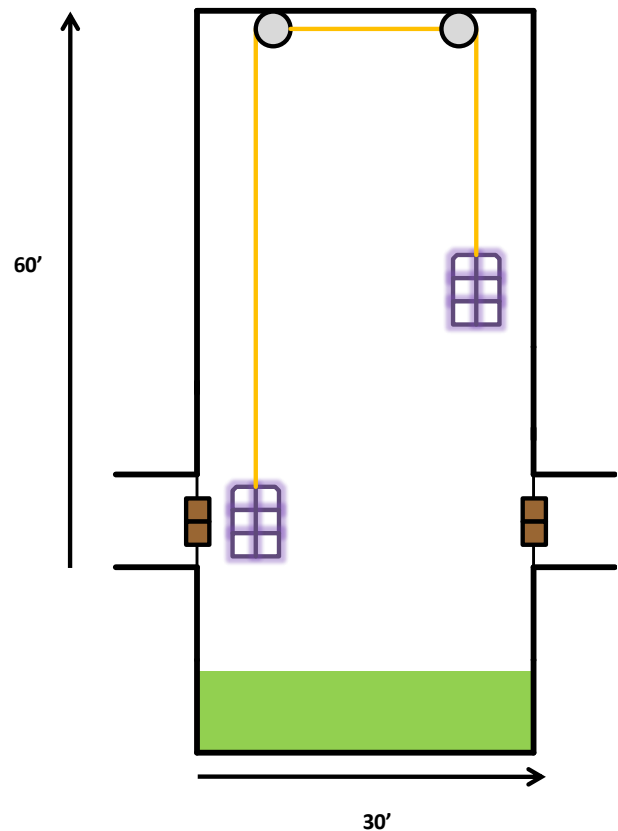

Thieves' Gauntlet

Listen: You hear nothing.

You are unable to see very far into this long, narrow room because a 10' high block of stone obscures your vision. You will have to scale the block to see what lies beyond.

As soon as a character steps into this room, a *Wall of Force* seals the entrance, preventing escape. Once the Climbing Block is scaled (see below) the *Wall of Force* begins to advance by 5' every round. If a character is hit by the *Wall of Force*, they are pushed along with it. If someone is at the bottom of the Pit Trap when they *Wall of Force* reaches them, they are crushed to death.

All of the traps in this room can be disarmed with a *Lockpicking* -2 check. Locating a trap's control box requires a *Notice* -2 check.

Climbing Block: Requires a simple *Climb* check to scale.

Pit Trap: This trap door reveals a 10' deep pit. Anyone jumping off the Climbing Block into the Pit sustains 2d6 points of falling damage. The trap can be easily circumnavigated if it is detected.

Blade Trap: Anyone who steps in the Blade Trap must pass an *Agility* -2 check or take 2d6 points of slashing damage.

Flame Trap: The Flame Trap is connected to a motion sensor instead of a pressure plate. Characters who trigger it must pass an *Agility* -2 check or sustain 2d10 points of fire damage (with a 2 in 6 chance of combusting)

Cold Trap: Anyone stepping on the Cold Trap must pass an *Agility* -2 check or take 2d6 points of cold damage and suffer -2 *Pace* for 3 rounds.

Sonic Trap: The Sonic Trap cannot be evaded. Anyone who triggers it takes 2d6 points of sonic damage and is deafened for 3 rounds, suffering a -1 penalty to all rolls.

Locked Door: The door can be opened with an unmodified *Lockpicking* check

Complications & Twists:

- Change the trap order or add new traps

Number of Exits: 2. This is a one-way room; the *Walls of Force* prevent adventurers from backtracking through the Gauntlet.

Rewards: The first person to successfully pass the *Thieves' Gauntlet* should receive one bonus *Experience Point*.

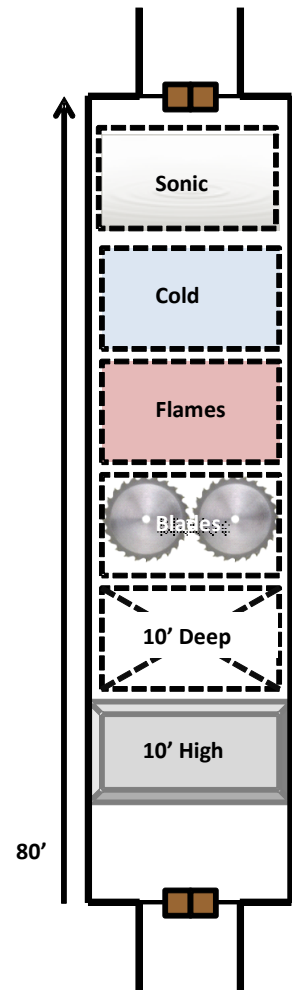

The Tiled Hall

Listen: You hear nothing.

The door opens to reveal a long narrow hall that looks to be about 80' long. The floor of the hall is colored with garish tiles in 10' by 10' sections: red, green, yellow and blue. You don't see any way to cross the room without stepping on the tiles.

Note: There is a player friendly version of the *Tiled Hall* map in Appendix D.

If any character has the presence of mind to check for traps, they see that all of the tiles are pressure plates. It is not possible to disarm any of these traps.

When a player steps on a numbered tile consult the reference below:

1. Monster Summoning Trap: A random monster appears in a puff of smoke! (Refer to Appendix C)

2. Spiked Pit Trap: The floor gives way revealing a 10'x10'x10' spiked pit. Make an *Agility* -2 check to avoid falling in. Characters who fall in take 1d6 points of falling damage and 2d6 points of piercing damage. 150 lbs. of pressure is required to activate the trap.

3. Safe: Nothing happens

4. Dart Trap: Poison darts shoot from the walls! Make an *Agility* -2 check to avoid begin hit. Characters that are hit take 2d4 points of damage and must make a *Vigor* -2 check or fall asleep for 1d4 hours.

Complications & Twists:

- Change up the number assignments of the floor tiles
- Add poison to the pit spikes (*Vigor* -2 or sustain 1 *Wound*)

Number of Exits: 2

Rewards: None

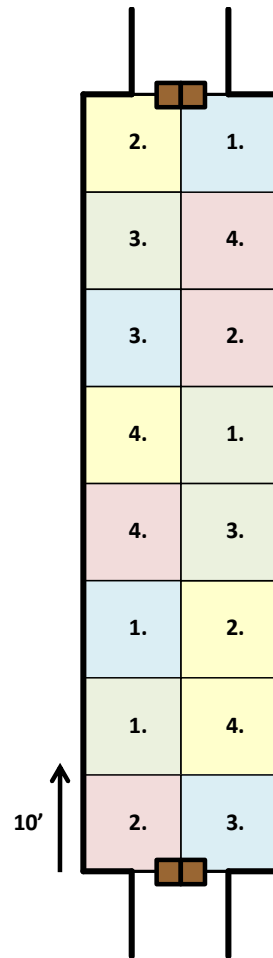

The Cloak Room

Listen: You hear nothing.

The walls of this dimly-lit room are covered with an assortment of cloaks and overcoats hanging from pegs. The garments come in all sizes and descriptions. Three torches mounted on central wall sconces provide minimal illumination. You don't see any other exits from this room.

If a person randomly selects a cloak and puts it on there's a 10% chance that it's a magical cloak (see *Rewards* below) and a 15% chance it's a *Cloak Wraith*. If possible the *Cloak Wraith* will wait until its host goes to sleep before attacking.

Characters who make a *Notice* check will detect the outline of the room's three secret doors but will discover no means of opening them. The only way to open the doors is to cover or extinguish the torch that faces it. Once the light is out, the door magically opens.

Complications & Twists:

- Replace the *Cloak Wraiths* with *Shadow Beasts*
- If all the torches are extinguished, 1d4 *Grues* show up

Number of Exits: 4

Rewards: There are a total of four magic cloaks in this room:

- *Cloak of Darkness:* This garment renders the wearer invisible to beings with night vision.
- *Cloak of Elvenkind:* +4 bonus to *Stealth*
- *Cloak of Defense:* Fabric stiffens when struck. Grants wearer *Armor +2* that stacks with other forms of armor.
- *Cloak of the Bat:* Grants the wearer the ability to safely fall from any height.

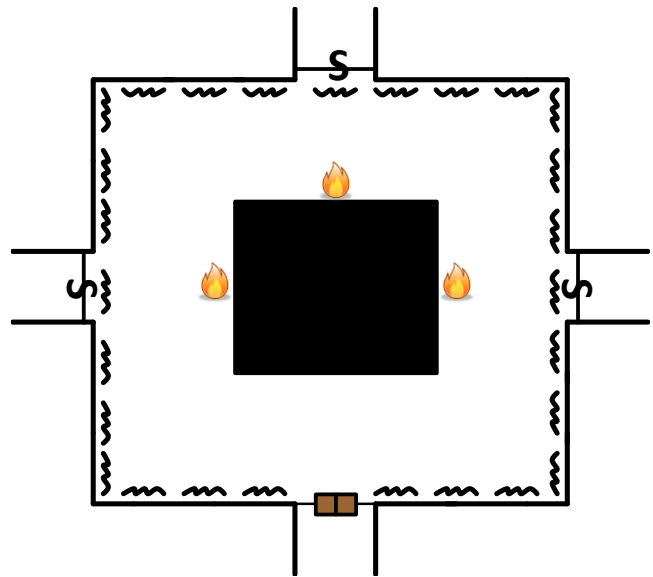

Cloak Wraith (6)

Strength: d8	Smarts: d6(A)	Agility: d6	Spirit: d6	Vigor: d8
Pace: 2	Parry: 5	Toughness: 6	Fighting: d6	Stealth: d12
Gear & Weapons: Choke (STR)				
Edges & Powers: <i>Drain Life</i> (+2 to hit; make a <i>Vigor</i> -2 roll or lose one die of <i>Strength</i> and gain a <i>Fatigue</i> level); <i>Magic Aura</i> (project an aura of magical enchantment); <i>Wall Walker</i> ; <i>Grapple</i> +4				

The Room of False Doors

Listen: You hear nothing.

The entire perimeter of this room is filled with identical looking doors.

All of the doors are locked, requiring a *Lockpicking* skill check to open. If the character opening the door succeeds a *Notice -2* check they will be able to determine whether or not the door is trapped (but will not be able to disarm it).

The doors labeled "B" are true exits. The doors labeled "A" lead to a trap-door pit in a short hallway. Characters must make an *Agility -2* check to avoid falling in; those that do fall 20' and sustain 2d6 points of damage. If any other door is opened consult the table below:

Die Roll (d6)	Effect
1-2	<i>False Door:</i> This doorway has been bricked up
3	<i>Crossbow Trap:</i> A loaded crossbow sits behind this door. It fires at you! Make an <i>Agility -2</i> check to dodge the bolt or sustain 2d6+1 points of damage.
4	<i>Fire Trap:</i> A blast of flame inflicts 2d10 points of damage to all targets in a Cone Template area. Targets have a 2 in 6 chance of combusting.
5	<i>Exploding Door:</i> Explosion inflicts 3d6 points of damage to all targets in a Small Blast Template area.
6	<i>Random Monster Spawn:</i> Refer to Appendix C

Complications & Twists:

- Add more door traps

Number of Exits: 4

Reward: None

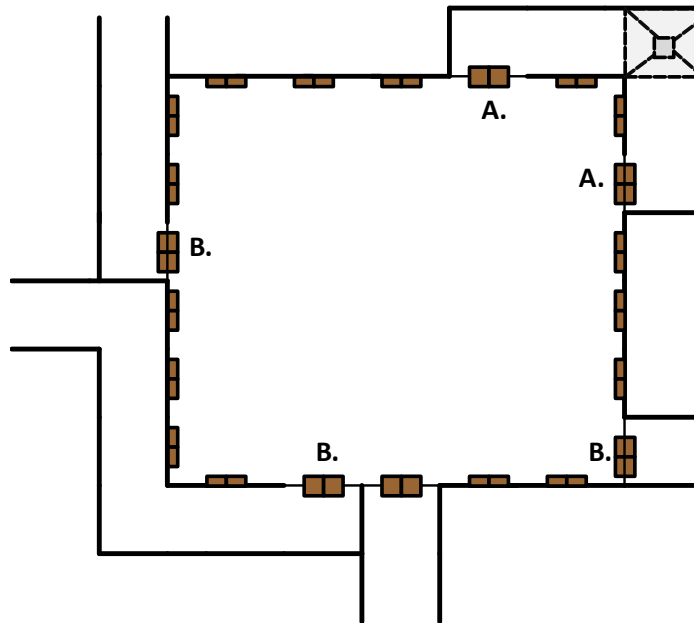

Teleportation Chamber

Listen: You hear nothing.

You have arrived at an apparent dead-end. The only feature in this otherwise completely unremarkable chamber is a shaft of white light that shines in the very center of the room. The beam is about 5' in diameter and extends from floor to ceiling. Small motes of sparkling light dance within the cylinder.

The moment that a character touches the shaft of light they are immediately teleported to another room. Draw a random room from the *Encounter Deck* and attach it to any available place on the map. If no unexplored hallways are available, place the new room off on its own in some remote corner of the map. The character appears in the exact center of this room (or as near to this as is possible taking solid obstacles into account). If appearing in the center of the room would plunge the character into some immediate peril (such as, say, a vat of acid) then such is their fate.

All other characters who touch the light appear in the same room in or around the same location as the first character.

For dramatic effect, do not describe the destination to any party members who refuse to step into the teleporter. If necessary, split the party to maintain the air of secrecy.

Complications & Twists:

- None. The destination is randomly determined every time.

Number of Exits: 2. The only other exit from this room is the teleporter. Once a character teleports through, they cannot teleport back.

Rewards: None

The Kitchen

Listen: You hear sizzling sounds and high-pitched voices.

The smells of someone moderately acquainted with the Art of Cookery assaults your nose as you open the door to this room. The place is outfitted to serve as a kitchen and pantry. Smoke from the cook fires drifts up through a hole in the ceiling. You see six kobolds and a hobgoblin in an apron doing prep tasks on a large, butcherblock table.

Grongdonk hates to be bothered when he's formulating culinary masterpieces. He orders his *sous* to attack and lunges at the party, whirling his cleaver like a madman.

Complications & Twists:

- Replace Grongdonk Blijosk with a visiting *Mind Flayer* chef, Slivith Hool
- Replace Grongdonk Blijosk with a visiting *Cambion Demon* chef, Drin Zarth

Number of Exits: 3. In addition to the two doorways leading into this room, it is possible to exit Castle Farkinwald by shimmying up the chimney here. The chimney is only 3' wide and is 100' tall but can be scaled if a character passes four consecutive *Climb* checks.

If someone is able to shrink themselves to 1' in size, they could also ride the dumbwaiter up to *The Banquet* (but they will be served as a course if they do this).

Rewards: Most of the food is disgusting but if someone searches the food preparation area they will find one week's worth of edible rations.

Kobolds (6)

Strength: d4	Smarts: d4	Agility: d10	Spirit: d6	Vigor: d6
Pace: 6	Parry: 4	Toughness: 4	Fighting: d4	Shooting: d8
Gear & Weapons: Kitchen Knife (STR + d4)				
Edges & Powers: <i>Infravision</i> (can see in the dark); <i>Sprint</i> (roll a d10 when <i>Sprinting</i>); <i>Cunning</i> (+2 to all <i>Stealth</i> and <i>Taunt</i> rolls); <i>Cowardly</i> (will only fight while the odds are in their favor)				

"The Chef" Grongdonk Blijosk, Hobgoblin (WC)

Strength: d8	Smarts: d6	Agility: d6	Spirit: d10	Vigor: d8
Pace: 6	Parry: 7(6)	Toughness: 7(6)	Fighting: d8	
Gear & Weapons: Cleaver (STR + d6); Leather Apron (Armor +1)				
Edges & Powers: <i>Infravision</i> (can see in the dark); <i>Frenzy</i> (can make 2 attacks per round at a -2)				

Courtyard of Soldiers

Listen: You hear low muttering and the clank of metal objects.

This expansive courtyard is filled with armed and armored soldiers making preparations for battle. A runic "F" is emblazoned on the soldiers' gear marking them as members of Farkinwald's private army. At the back stands a larger more impressively dressed soldier who, upon seeing you, calls his men to attention. It seems that matters will come to blows very shortly.

Roll a d6 to determine the type and quantity of soldiers camped out in the courtyard:

Die Roll (d6)	Soldier Type
1	25 <i>Hobgoblins</i> + 1 <i>Hobgoblin Captain (WC)</i>
2	40 <i>Kobolds</i> + 1 <i>Kobold Shaman (WC)</i>
3	25 <i>Evil Men</i> + 1 <i>Mercenary Captain (WC)</i>
4	10 <i>Ogres</i> + 1 <i>Ogre Chieftain (WC)</i>
5	10 <i>Minotaurs</i> + 1 <i>Minotaur Chieftain (WC)</i>
6	4 <i>Frost Giants</i> + 1 <i>Frost Giant Jarl (WC)</i>

The soldiers won't stupidly line up at a choke point (such as a doorway) and let the party burn them down one by one. If the party tries to hold a tactically advantageous position the soldiers will use missile fire or reach weapons to try and goad them into charging. If the party is using missile fire to great effect, the soldiers will try to move into blind spots to pull the ranged attackers forward. And, if all else fails, the soldiers will bull rush the party's position (using touch attacks and opposed *Strength* rolls) to try and crack their lines.

The soldiers are under orders to accept quarter and take prisoners if the party chooses to surrender. Prisoners are transported to *The Jail*.

Climbing Out:

Characters who wish to scale the 50' high walls can climb out of Castle Farkinwald. They'll find themselves somewhere within the grounds of the castle and will need to scale another 100' high wall to truly break free (since all of the gateways are underground). It is impossible to gain access to any other rooms of the castle by climbing out of this room -- from the outside the buildings of the castle are just windowless, door-less stone slabs for as far as the eye can see.

Complications & Twists:

- None

Number of Exits: 2

Rewards: Each soldier carries 1d6+1 gold pieces.

The Rope Bridge

Listen: You hear nothing.

A 40' wide chasm bisects this room into two halves. Spanning it is a rickety looking rope bridge that has seen better days. The only other exit from this room is located on the opposite side of the bridge. A cursory inspection reveals that the chasm descends at least as far as you can see.

Attempting to cross the bridge requires a simple *Agility* check, modified by the character's total weight. If more than 300 pounds are put on the bridge at once, it immediately breaks. Characters who are on the bridge when it breaks must make a *Strength* check to maintain their grip and then must make one or more *Climb* checks to reach the safety of the ledge. Any failures result in falling down the chasm.

Character Weight	Agility Modifier
<100	0
101-150	-1
151-200	-2
201-250	-3
251-299	-4
300+	Bridge Breaks

Those who slip and fall off the rope bridge are in for quite a ride. The chasm is approximately 100' deep; anyone who falls down it sustains 10d6 points of damage. The bottom of the chasm is strewn with broken bones, refuse and a number of opportunistic rats.

Complications & Twists:

- Anyone who falls down the chasm lands in the *Great Underground River*. They sustain 5d6 points of falling damage and must survive 6d6 rounds of submersion in the water before being deposited somewhere outside the dungeon.
- The chasm is seemingly bottomless. Anyone who has the misfortune of falling down it seems to plummet for an age before their rate of descent gradually declines to nothing. The fallen characters find themselves in a strange realm hidden in the center of the world -- but that's an adventure for another day!

Number of Exits: 2

Rewards: Digging through the refuse at the bottom of the chasm uncovers 4d20 gold coins.

Fungus Forest

Listen: You hear nothing.

This room has been completely overgrown by a riotous array of multi-colored mushrooms, toadstools, molds and other fungi -- some growing as high as 20' tall. A carpet of thick pink mold covers the entire floor, leaving no clear path to the door on the other side of the room.

At the slightest touch these fungi will release a cloud of spores. Every 5' square of the room will trigger its own spore cloud when stepped upon. Use the table below to randomly determine the spore effect.

If the characters elect to burn the fungi, they will enrage the *Mushroom King* who will attack at once!

Only those characters who are immune to *Poison* can resist the effects of the spores.

Die Roll	Spore Effect
1	<i>Hallucination:</i> Ooh! Pretty colors! You are tripping the light fantastic for the next 2d6 hours. Suffer a -1 penalty to all rolls.
2	<i>Intense Hunger:</i> You are overwhelmed by a sensation of gripping hunger. You immediately gorge yourself on 1d4 days worth of rations. If you have no rations you instantly suffer one <i>Fatigue</i> level.
3	<i>Narcolepsy:</i> Your eyelids feel extremely heavy and you're finding it really hard to stay awake. Succeed a <i>Spirit</i> -2 check or fall asleep for 1d6 hours.
4	<i>Rage:</i> Higher brain functions temporarily shut down and you become a raving, homicidal maniac for 2d6 rounds. You will attack anything that is in your line of sight, regardless of whether its a friend or a foe.
5	<i>Telepathy:</i> Your mind is suddenly filled with a torrent of whispering voices. You realize after a moment of disorientation that you are hearing the thoughts of your companions. Gain telepathic abilities for the next 1d4 hours.
6	<i>Fear:</i> A sensation of primal fear assaults your limbic system. It tells you to "Run!" Succeed a <i>Spirit</i> -2 check or sprint at full speed away from this room for the next 2d6 rounds, heedless of any dangers you may encounter.
7	<i>Stupidity:</i> Suddenly you..... Uhhhhh. Succeed a <i>Vigor</i> -2 check or suffer a two step decrease to your <i>Smarts</i> die for the next 1d6 hours.
8	<i>Delusional:</i> You're convinced that you are someone or something other than what you are. Succeed a <i>Spirit</i> -2 check or gain the <i>Major Psychosis</i> hindrance.

Complications & Twists:

- Add whatever random spore effects you see fit

Number of Exits: 2

Rewards: Someone who has specific *Knowledge* of herbs, plants or fungi can attempt to harvest 1d4 doses of spores for later use. These spores can be used as a touch attack to infect a target. Additionally, 1d4 days worth of edible mushrooms can be harvested.

Mushroom King (WC)				
Strength: d12+1	Smarts: d6	Agility: d6	Spirit: d8	Vigor: d10
Pace: 5	Parry: 5	Toughness: 10	Fighting: d6	
Gear & Weapons: Bash (STR)				
Edges & Powers: <i>Spore Blast</i> (can spray spores over a cone shaped area; see the "Fungus Forest" encounter for more details)				

The Shaft

Listen: You hear rattling chains and the occasional hoot of some animal.

The recessed floor of this shaft-like room is filled with sharp spikes. Looking up you can see an assortment of bars, ledges and hanging chains that lead up toward a trap-door in the ceiling. Two scaly, red-eyed apes holler at you as they swing effortlessly from ledge to ledge.

It will require a heroic show of *Climbing* to reach this room's exit. It takes three separate *Climb* checks to reach the room's ceiling. The apes, of course, will do their utmost to knock climbers down into the spikes. Any time a climber is *Shaken*, they must succeed a *Climb* -2 check to retain their grip (same goes for the apes).

If a character falls they are afforded a chance to make a desperation grab before plunging into the spikes. This second attempt is resolved as an *Agility* -2 check. If the character succeeds they manage to grab on to a bar or chain before hitting the bottom.

Landing on the spikes inflicts 2d6 points of piercing damage plus 1d6 points of falling damage for every 10' fallen.

Complications & Twists:

- None. This room always presents a physical challenge

Number of Exits: 2

Rewards: None

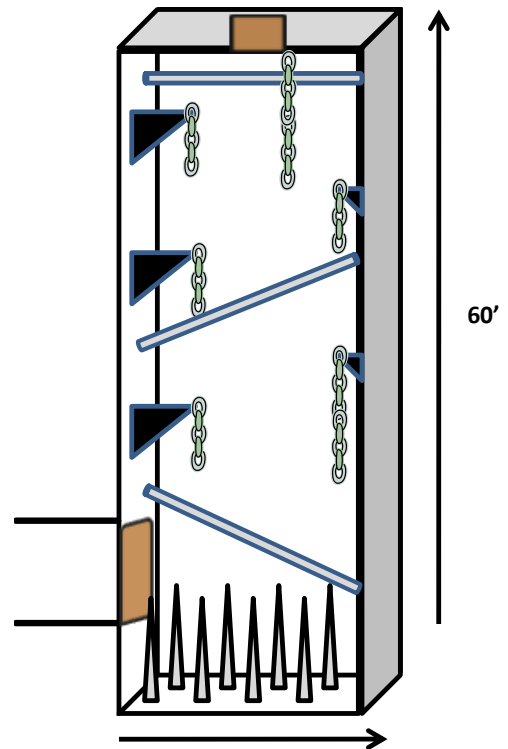

Demonic Apes (2)

Strength: d12+1	Smarts: d6 (A)	Agility: d8	Spirit: d6	Vigor: d8
Pace: 8(6)	Parry: 6	Toughness: 8	Fighting: d8	Climbing: d10
Gear & Weapons: Bash (STR)				
Edges & Powers: <i>Demon</i> (+2 to recover from <i>Shaken</i> ; immune to disease and poison; 1/2 damage from normal weapons); <i>Leaping</i> (can broad jump 4 squares +2 for every success and <i>Raise</i> on their <i>Strength</i> roll); <i>Brachiation</i> (can move via swinging at a <i>Pace</i> of 6)				

The Pantheon

Listen: You hear no sound whatsoever.

The door opens to reveal a quiet shrine dedicated to a trio of deities. Three large altars occupy the center of the room; upon them stand icons carved from stone *[insert icon descriptions here]*. Your eye detects the faint glint of precious stones embedded in the eye sockets of each statue. Prayer mats with offering dishes and candles are arranged in front of each altar.

Randomly determine which deities the shrines are consecrated to using the table below. Describe the aspect of each icon to the party. Characters with *Knowledge: Religion* can attempt to discern which deities the icons represent and what the likely boons and curses of those deities would be.

If a character wishes to pray before an altar they must make a *Faith* roll to try and appease that deity (characters without any ranks in *Faith* can attempt a *Spirit* -2 roll). If the character succeeds they receive a boon from the deity; if they fail they are cursed in some way (see below).

Any attempt to desecrate the icons results in failure for the entire party but defilers can pry 2 gemstones valued at 1d4x100 gold a piece from each statue.

You can only attempt to pray at an altar once per visit to Castle Farkinwald.

Card	Deity	Icon	Fail	Succeed
2♣	Finbar	Thin, bearded man holding a traveler's walking staff	Suffer a -2 <i>Pace</i> for the rest of the adventure.	Gain a +2 <i>Pace</i> for the rest of the adventure.
3♣	Shyessa	A slender young woman in scale mail drawing a great bow	Suffer a -2 penalty to all <i>Shooting</i> rolls for the rest of the adventure.	Gain a +2 bonus to all <i>Shooting</i> rolls for the rest of the adventure.
4♣	Polpero	A robust, robed man holding a bag of coins	All of your coin on hand disappears.	500 gold pieces magically appear in your backpack.
5♣	Cerdic	An old man, seated, reading a large book	Automatically receive disinformation from all <i>Knowledge</i> checks for the rest of the adventure.	Gain a +2 bonus to all <i>Knowledge</i> checks for the rest of the adventure.
6♣	Ducoda	Burly man with a smith's hammer swinging down on an anvil	A random metal item becomes brittle. 1 in 6 chance of shattering on contact.	Primary weapon gains a permanent +1 to damage.
7♣	Kyrene	A haloed woman clutching a book to her chest	Suffer a one step decrease to your <i>Spirit</i> die for the rest of the adventure.	Gain a one step increase to your <i>Spirit</i> die for the rest of the adventure.
8♣	Rowan	A woman dressed like an adventurer, holding a torch aloft.	Suffer a -2 penalty to all <i>Guts</i> and <i>Spirit</i> checks for the rest of the adventure.	Gain <i>Fear</i> immunity for the rest of the adventure.
9♣	Ransul	A craggy, stone-skinned man appraising a gem.	<i>Cursed!</i> You have acquired the Miser's Touch! Any gold you touch turns to lead for the rest of the adventure.	A gem valued at 1d6x200 gold pieces magically appears in your pack.

10♣	Halzar	A nude man with flaming hair holding a sword aloft	Become <i>Blind</i> for the rest of the adventure.	Weapon inflicts +1d6 points of <i>Fire</i> damage for the rest of the adventure.
J♣	Kelsi	An attractive nymph standing in a spray of water	Suffer a -2 penalty to resist the effect of any <i>Charms</i> for the rest of the adventure.	Immune to <i>Charms</i> and mental compulsion for the rest of the adventure.
Q♣	Vorist	A gaunt woman with unbound hair and long, dagger-like claws	Inflict -2 melee damage for the rest of the adventure.	Inflict +2 melee damage for the rest of the adventure.
K♣	Rilestu	A masked man wielding a rapier.	<i>Cursed!</i> You are overwhelmed by greed for the rest of the adventure.	Secretly take any item you wish from another party member.
A♣	Malos	A cloaked cripple with a mocking grin leaning on a walking stick	You contract a plague. Make a <i>Vigor</i> -2 check or die ugly.	Immune to hunger and disease for the rest of the adventure.
2♦	Jardox	A wild-haired, bearded man roaring with fists clenched.	A dreadful chill passes through you. Make 3 <i>Vigor</i> -2 rolls and suffer a <i>Fatigue</i> level for each failure.	Immune to <i>Cold</i> damage for the rest of the adventure.
3♦	Bansule	A motherly looking, robust woman holding a cornucopia	All of your rations on hand disappear.	Your rations on hand are doubled.
4♦	Skelper	A man holding a pair of dice in one hand and a wine goblet in the other	Lose one <i>Benny</i>	Gain one <i>Benny</i>
5♦	Asero	A man balancing on one foot with his hands steeped in prayer	You feel unnaturally sluggish. Suffer a one step decrease to your <i>Agility</i> die for the rest of the adventure.	You can <i>Jump</i> twice as far as normal for the rest of the adventure.
6♦	Quilessa	A serene looking robed woman forming a cradle with her hands.	Natural healing is suspended for one week.	All of your <i>Wounds</i> and injuries are healed.
7♦	Ardagon	An armored man down on one knee holding a massive tower shield aloft	Suffer -1 <i>Toughness</i> for the rest of the adventure.	Gain +1 <i>Toughness</i> for the rest of the adventure.
8♦	Tinual	An elfin-looking man playing a mandolin.	Permanently suffer -1 <i>Charisma</i>	Permanently gain +1 <i>Charisma</i>
9♦	Endatha	A mouth-less woman in a stole sitting cross-legged.	<i>Cursed!</i> Rendered mute for the rest of the adventure. Spellcasting is impossible.	You can see through all <i>Illusions</i> for the rest of the adventure.
10♦	Omard	A bald man in a toga examining an unrolled parchment.	The next time you return to a civilized area you will suffer a permanent -2 <i>Charisma</i> penalty with the citizens of that city.	The next time you return to a civilized area you will enjoy a permanent +2 <i>Charisma</i> bonus with the citizens of that city.
J♦	Danth	An athletic boy in a toga holding a discus tucked in	Suffer a one step decrease to your <i>Strength</i>	Gain a one step increase to your <i>Strength</i> die for

		one hand.	die for the rest of the adventure.	the rest of the adventure.
Q♦	Ilesso	A woman in a long gown with one perfect breast exposed and half her face obscured by a veil.	Lose all of your <i>Bennies</i>	For the rest of the adventure, when you use a <i>Benny</i> you have a 2 in 6 chance of keeping it.
K♦	Shar	A woman in a toga with a mane of wind-blown hair grown down to her feet. She points into the distance.	<i>Zot!</i> You are struck by a bolt of lightning for 3d6 <i>Electricity</i> damage.	Immune to <i>Electricity</i> damage for the rest of the adventure.
A♦	Hondmar	A man with a top-knot wearing a <i>Gi</i> and saluting with a blade.	Suffer a -1 to all <i>Fighting</i> rolls for the rest of the adventure.	Gain a +1 to all <i>Fighting</i> rolls for the rest of the adventure.
2♠	Nalb	A robed and bearded man holding a flask in one hand and a stone in the other.	<i>Cursed!</i> You completely lose your sense of taste for the rest of the adventure.	You can identify all magic potions by sight for the rest of the adventure.
3♠	Anwyn	A burly man in an antlered great helm with a spear poised for throwing.	<i>Cursed!</i> A random wandering monster begins to pursue you. It will arrive in 2d6 rounds.	You can spend <i>Bennies</i> to re-roll your damage for the rest of the adventure.
4♠	Jeruku	A wrinkled old crone with tears streaming down both cheeks.	<i>Cursed!</i> Every time one of your companions is <i>Shaken</i> , you're <i>Shaken</i> too!	Every time you <i>Wound</i> a target, all adjacent targets must pass a <i>Spirit</i> check or become <i>Shaken</i> .
5♠	Nomos	A thin man with long spiky hair wearing a billowing shroud.	You immediately fall into a coma-like slumber for 2d6+2 hours.	You no longer feel the need to sleep for the remainder of the adventure.
6♠	Shessik	A woman with a split face. One half smiles and the other half frowns.	<i>Cursed!</i> You are unable to utter any true statements for the rest of the adventure.	You can <i>Detect Lies</i> for the rest of the adventure.
7♠	Ghalorn	A man with a trimmed beard in workman's clothes holding a perfect dodecahedron in his hands.	Act as if you have the <i>All Thumbs</i> hindrance for the rest of the adventure	You inflict an extra 1d10 damage to all constructs and golems for the rest of the adventure.
8♠	Sholooth	A cloaked eyeless woman with six-fingered hands outstretched.	<i>Cursed!</i> Your gender is permanently changed to the opposite sex.	Can automatically open any single locked portal or chest.
9♠	Targamant	A heavily armored man wielding a sword and shield	-2 to recover from <i>Shaken</i> for the rest of the adventure.	+2 to recover from <i>Shaken</i> for the rest of the adventure.
10♠	Sulijess	A woman with arms outstretched, one thumb pointing up and the other pointing down.	<i>Cursed!</i> The next time you are in a civilized area, you will be arrested for breaking an obscure law.	'Get out of Jail free' card: You can avoid any single arrest or incarceration while in a civilized area.
J♠	Morwenna	A vampiric looking woman in a sleek dress and hooded cloak	<i>Cursed!</i> When your character dies, you will rise as a Vampire	Gain permanent night vision.

Q♠	Ygdra	An old crone holding an hourglass	You become elderly. Suffer a permanent one step die reduction to <i>Strength</i> , <i>Vigor</i> and <i>Agility</i>	Your lifespan is doubled and you are permanently immune to the effects of magical aging.
K♠	Ildrath	A tall figure in plate mail that appears to have been broken into pieces and then put back together badly.	The next time you are damaged in battle you sustain an extra 2d6 damage.	Your attacks gain +2 <i>Armor Piercing</i> for the rest of the adventure.
A♠	Cromlech	A cowed figure holding a key in one hand and pointing at you with the other.	You die!	You can "cheat death" one time, surviving with 3 <i>Wounds</i> .
2♥	Balmora	A crouching, three-eyed woman with writhing hair	You go insane! Gain the <i>Delusional Hindrance</i>	You can comprehend and translate any alien or foreign language for the rest of the adventure.
3♥	Belwyn	A slender young girl with fairy wings.	Suffer a one step decrease to your <i>Vigor</i> die for the rest of the adventure.	Gain a one step increase to your <i>Vigor</i> die for the rest of the adventure.
4♥	Rusk	A robust, hairy man wearing an animal skin and a laurel crown.	You are <i>Shape Changed</i> into an animal for the rest of the adventure.	Gain ability to <i>Speak with Animals</i> for the rest of the adventure.
5♥	Alesta	A modestly dressed young woman holding a swaddled infant.	If you were ever planning on having children, forget about it.	If female, you become pregnant; if male, you impregnate the next female you sleep with.
6♥	Winlock	A bearded man with wind-blown hair peering through a spyglass.	Become seasick. Suffer a one step decrease to <i>Agility</i> for the rest of the adventure.	Gain <i>Water Breathing</i> for the rest of the adventure.
7♥	Teldria	A stylishly dressed noble looking woman with a hand outstretched, palm up	<i>Cursed!</i> No matter what you say for the rest of the adventure, it comes across as a scathing insult.	All sentient monsters will initially be friendly toward you for the rest of the adventure.
8♥	Nyxera	A woman in a wolf skin standing before a full moon.	Contract <i>Lycanthropy</i> . Become a werewolf on the next full moon.	Your senses are heightened for the rest of the adventure. Gain a +2 bonus to all <i>Notice</i> checks.
9♥	Herebu	An old, one-eyed man standing with his back to you.	<i>Cursed!</i> You forget anything that's more than an hour old for the rest of the adventure.	Automatically identify the next <i>Magic Item</i> that comes into your possession.
10♥	Elora	A young, attractive woman holding a quill pen to her breast.	<i>Cursed!</i> For the rest of the adventure, anytime you speak it must be done in song.	Instantly gain 5 experience points.
J♥	Phalen	A blindfolded man in torn	Permanently gain the	Permanently gain the

		clothes standing in a cruciform pose.	<i>Poverty</i> Hindrance.	<i>Holy Warrior</i> Edge.
Q♥	Mikasti	A fabulously gorgeous nude woman with arms outstretched.	Fall madly and permanently in love with a random party member.	Gain a +2 <i>Charisma</i> with members of the opposite sex for the rest of the adventure.
K♥	Karn	A burly, bare-chested man with an axe in each hand.	Suffer a -4 penalty to all <i>Soak</i> rolls for the rest of the adventure.	Gain a +4 bonus to all <i>Soak</i> rolls for the rest of the adventure.
A♥	Arcanus	A robed, faceless man holding a staff in one hand and an orb in the other.	Lose all of your <i>Power Points</i>	Gain your full complement of <i>Power Points</i>
Joker	The Jongleur	A jester in fool's motley clutching a scepter.	Suffer a -2 penalty to <i>all rolls</i> for the rest of the adventure.	Gain a +2 bonus to <i>all rolls</i> for the rest of the adventure.

Complications & Twists:

None. You should encounter a different deity each time you run through the Castle. If not, feel free to re-draw until you do.

Number of Exits: 3

There are two exits from this room, the way you came in and a door located behind the altar.

Rewards:

None, beyond whatever divine boons get bestowed.

The Duelists

Listen: You hear the sounds of swordplay. *Listen (-2):* It sounds like two people having a sword duel.

You open the door to find two warriors earnestly trying to kill one another. One, suited in red-enameled plate mail, swings a Greatsword at another swordsman in white scale mail armor who dances just at the edge of the larger man's reach. The white warrior has his cloak wrapped around one hand and a gleaming longsword in the other; he is flicking his cloak at the red knight's eyes to try and distract him. Upon seeing you out of the corner of their eyes both men call out. "Aid me, friends!" yells the red knight. "Help me put down this backstabbing scoundrel!" The man in white counters, "Don't listen to him! He works for the wizard! Come, let's silence this dog!"

Play out the combat normally to determine a victor. The party can choose to do nothing, aid one versus the other, or kill both. Kelwin is using his cloak to try and fluster Sir Tristan. He's performing a *Smarts* trick and attacking every round (incurring a multi-action penalty).

If the Red Knight Wins:

He thanks the party for their efforts and let's them have Kelwin's stuff. He explains that he had fallen in some kind of suspended animation trap and has no idea how long he's been trapped here. If he is told what year it is he becomes visibly upset and indicates that he would like to leave as soon as possible, but that he's willing to aid the party until they can guide him to an exit.

If the White Warrior Wins:

He magnanimously lets the party have their pick of Sir Tristan's things and offers to tag along with the party. He claims to be a professional adventurer who had become separated from his party when Sir Tristan fell upon him. What he doesn't say is that he's a despicable scoundrel who murdered his previous companions over a loot division dispute. He likes to pretend that he's virtuous but he's really just in it to get as much treasure as he can. Kelwin will claim to know the location of a secret treasure stash (he'll know it when he sees it) and has offered to let the party in on it if they let him join. Of course he's just saying this to buy time to plot a fresh betrayal.

The Red Knight:

Sir Tristan Greyarch (WC)

Strength: d10	Smarts: d6	Agility: d8	Spirit: d10	Vigor: d10
Pace: 6	Parry: 7	Toughness: 13(7)	Fighting: d10	
Gear & Weapons: Knight's Plate (Armor +6); Greatsword (STR + d10); 2d10+5 gold pieces				
Edges & Powers: <i>Block, Command, Frenzy, Noble, Combat Reflexes, Fervor, Level Headed</i>				

The White Warrior:

Kelwin Brightblade (WC)

Strength: d10	Smarts: d8	Agility: d8	Spirit: d8	Vigor: d8
Pace: 6	Parry: 9	Toughness: 9(6)	Fighting: d12+1	
Gear & Weapons: Scale Armor (Armor +3); Longsword +1 (STR + d8 + 1); 4d10+10 gold pieces				
Edges & Powers: <i>Block, Combat Reflexes, Command, Fervor, Hold the Line</i>				

Number of Exits: 4

Rewards: Whatever loot is taken from the fallen duelist(s)

The Champion

Listen: You hear nothing.

This unadorned room has one other exit. Before it stands an imposing, 7' tall figure in black plate mail armor wielding a Greatsword that ripples with ebon fire. The dark knight raises a hand toward you and decrees, "THOU SHALT RETURN FROM WHENCE THOU CAME, MORTAL. THIS WAY IS CLOSED TO THEE."

So long as the Champion lives, the door he is guarding shall remain locked (it is soul-bound to him).

Complications & Twists:

- Replace the Black Knight with a Skeleton Knight.
- The Black Knight's helmet remains after he is destroyed. If anyone puts it on, they become a Black Knight and must take up the Champion's duty.

Number of Exits: 2

Rewards: The Black Knight erupts into flames when killed so you cannot loot his weapon and armor.

Black Knight (WC)

Strength: d12	Smarts: d6	Agility: d8	Spirit: d8	Vigor: d10
Pace: 6	Parry: 9	Toughness: 13(7)	Fighting: d10	
Gear & Weapons: Knight's Plate (Armor +6); Balefire Great Sword (STR+d10 damage; 1 in 6 chance of combusting)				
Edges & Powers: <i>Arcane Resistance</i> (+2 <i>Toughness</i> vs. Magic); <i>Demon</i> (+2 to recover from <i>Shaken</i> ; immune to disease and poison; 1/2 damage from normal weapons); <i>Weakness: Cold Iron</i> (take normal damage from Cold Iron weapons); <i>Improved Frenzy</i> ; <i>Improved Block</i> ; <i>Improved Sweep</i> ; <i>Level Headed</i> ; <i>Fast Regeneration</i> (make a <i>Vigor</i> check each round to heal 1 <i>Wound</i>)				

The Treasure Vault

Listen: You hear nothing.

A pile of glittery, tantalizing treasure lies just out of reach beyond an iron door. You can see a large pile of loose gold coins, several gemstones and a wooden chest.

The iron door is triple-locked and trapped. Each lock requires a *Lockpicking* -2 skill check to overcome. If any of the skill checks fail a poison needle trap is activated and the lock picker must succeed an *Agility* -2 check to avoid getting pricked. Victims of the trap need to pass a *Vigor* -2 check or die. If any *Lockpicking* check succeeds with a *Raise*, the trap is disarmed.

The instant the door is opened, hidden grates in the floor open up causing the gold and jewels in the vault to begin sinking out of sight. The party will need to act fast to grab what gold it can! It takes 5 rounds for the gold to disappear; each round a character can make an *Agility* roll to scoop up as much gold as possible. Multiply the result of the roll by 10 to determine how many coins the character collects. For each *Raise* rolled on the *Agility* check, the character also manages to grab one gemstone.

The Chest:

The chest is not trapped and can be opened normally.

Complications & Twists:

- Instead of sinking into the floor, the gold is illusory. As soon as the party leaves the dungeon it disappears.
- Instead of sinking into the floor, the gold has been tagged with a magical locator spell. Summoned *Invisible Stalkers* will hunt the owners of the gold until it is dropped.

Number of Exits: 3

Rewards: There are approximately 6000 gold pieces in loose coin and 2d12 gemstones valued at 500 gold pieces each on the floor of the vault. The chest contains a *Potion of Healing*, a *Bag of Holding* and *Bracers of Armor +1*.

Anti-Gravity Chamber

Listen: You hear nothing.

You feel a sensation of weightlessness as you open the door to this spherical room. Four, strange looking abominations float in the middle of the air. They look like man-sized floating brains with sharp beaks protruding from their undersides and six long tentacles trailing behind. From the look of things they are perfectly at home in this gravity free environment.

Movement in this room is very challenging. Character who try to "swim" in the zero gravity will only have a *Pace* of 1 and will suffer a -2 to all rolls. Characters who want to launch themselves off the walls of the room must make a successful *Piloting* check. This allows the character to travel at a *Pace* of 6 in a straight line with no penalties to their die rolls. Failing a *Piloting* check causes the character to careen recklessly into a wall, suffering 2d6 points of falling damage.

Tip: use a six-sided die to represent the altitude of each combatant in this room. Remember that characters with a higher altitude gain a +1 bonus to *Fighting* rolls against lower altitude targets.

The Grell will not pursue targets out of this chamber.

Complications & Twists:

- None.

Number of Exits: 4

Rewards: None

Grell (4)				
Strength: d6	Smarts: d10	Agility: d8	Spirit: d10	Vigor: d6
Pace: 6 (Fly)	Parry: 6	Toughness: 6	Fighting: d8	
Gear & Weapons: Bite (STR + d6)				
Edges & Powers: <i>Fly</i> (Grell can levitate at <i>Pace</i> 6); <i>Paralyzing Touch</i> (+2 to hit; make a <i>Vigor</i> -2 save or be paralyzed for 3 rounds); <i>Improved Frenzy</i> (can make 2 attacks per round); <i>Tentacles</i> (Reach +1)				

The Magnetic Chamber

Listen: You the sound of metal grinding on metal.

Against one wall of this room you see a fearsome looking contraption. It features two large spiked rollers grinding against each other. You can feel some invisible force perceptibly tugging at the buckles of your armor.

As soon as a character steps into the room they come under the influence of a powerful magnet. If they are holding any metal items they will have to win a tug-of-war every round with the magnet or lose the item permanently as it gets ground up by the machine. Anyone wearing metal armor runs the risk of being ground to pieces if they lose the tug-of-war battle.

The magnet has a *Strength* of $d12+2$. Metal-wearing characters must succeed an opposed roll against the magnet's *Strength* to pass through the room. If the character wins the roll, they can move at $1/2$ their normal *Pace*; if they fail, they are pulled toward the magnet by a number of squares equal to the difference between the rolls. Once a character is pulled all the way to the grinder they are instantly killed by crushing forces.

The only way to stop the grinder from crushing is to jam it by throwing an adamantium object into the works.

Complications & Twists:

- None

Number of Exits: 3

Rewards: None

Monster Explosion

Listen: You hear a cacophony of sounds. There are a lot of somethings in there.

This large chamber is practically packed to the ceiling with monsters of various types. They come surging toward you the moment you open the door.

Make the room as big as it needs to be to accommodate the number of monsters drawn below. The monsters will simply try to overwhelm the party by main force, chasing them until they are slain.

Draw 3 times on the table below to determine the type and quantity of monsters in the room:

Card	Result
2	1d12+2 Kobolds
3	1d12 Hobgoblins
4	1d12 Evil Men
5	1d8 Air Mephits
6	1d8 Living Statues
7	1d6 Arachnaurs
8	1d6 Xorns
9	1d4 Mind Flayers
10	1d4 Ogres
J	1d4 Owl Bear
Q	1d4 Trolls
K	1d4 Minotaurs
A	1d4 Umber Hulks
Joker	1d2+1 Eye Tyrants

Complications & Twists:

- Look, if you want to make it worse, just pretend to draw three *Jokers*.

Number of Exits: 4

Rewards: If you defeat all the monsters you receive 1 bonus *Experience Point* on the spot

Farkinwald's Bedchamber

Listen: You hear nothing.

This room has the appearance of being some sort of lounge. Comfortable looking chairs line the walls and thick rugs cover the floors. A heavy curtain conceals what appears to be another room. As you enter, a seductive woman with long, straight black hair, pointed ears and red eyes emerges from behind the curtain. She's wearing a diaphanous light green tunic that provides neither warmth nor modesty. Her expression is caught somewhere between being impressed and amused. "So," she asks, "I don't suppose you're here to rescue me from the clutches of that disgusting, old wizard are you?"

The woman's name is Lustriel Mellith. She is an accomplished sorceress and half-blooded demon. Lustriel has been Farkinwald's favorite mistress for the past several years and has begun to grow tired of her captivity. The party represents a welcome diversion from her dull day to day routine.

If the party is courteous and refrains from attacking Lustriel, she will let them leave unmolested. If any characters have a *Charisma* greater than zero, Lustriel will take a special interest in them and begin flirting. Given enough encouragement, she will invite the most charming suitor back into the bedchamber to get to know her better while the rest of the party takes their ease in the lounge. The liquor cabinet is well stocked and the chairs are indeed very comfortable.

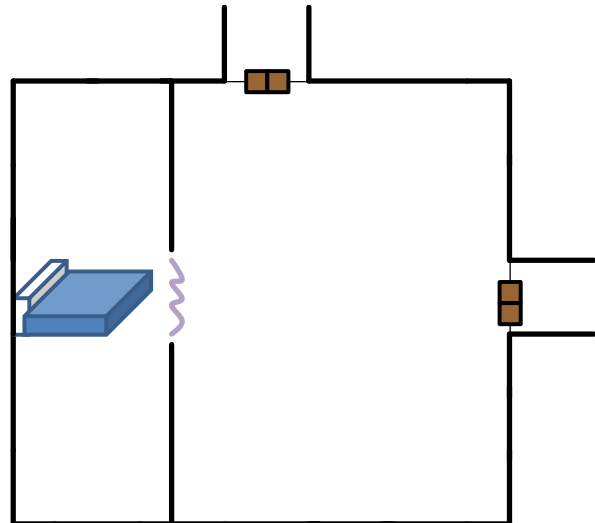

Lustriel's suitor has to prove that they are strong enough, clever enough, nimble enough, fit enough and determined enough to satisfy her. They must make a trait test for each attribute (*Strength, Agility, Smarts, Spirit* and *Vigor*), total up the number of successes and raises they roll and consult the table below:

# of Successes	Result
<1	You are the worst lover ever. Lustriel attacks you immediately!
1-4	You bore her, but she's decided not to kill you. Now GET OUT!
5-8	That was fun! Lustriel casts <i>Greater Healing</i> and on you and promises to mislead the guards if they ask her about you. Alternatively she will remove one <i>Curse</i> or <i>Disease</i> . Run along now before the Master comes home!
9	Oh take what you want, you cad! Lustriel confesses to being bored of Farkinwald and wants to come with you, if you'll have her.
10+	<i>Ooh-La-La!</i> You must be some kind of Love God! Lustriel is completely besotted with you. She insists that she joins you on your journeys and gives you a special gift, a <i>Ring of Second Chances</i>

Lustriel Mellith, Cambion Sorceress (WC)

Strength: d8	Smarts: d12	Agility: d8	Spirit: d12	Vigor: d8
Pace: 6	Parry: 6	Toughness: 6	Fighting: d8	Charisma: +6
Gear & Weapons: <i>Ring of Second Chances</i> (can self-resurrect from death 1 time with 3 Wounds); <i>Wand of Lightning</i> (20 Charges)				
Edges & Powers: <i>Demon</i> (+2 to recover from <i>Shaken</i> ; immune to disease and poison; 1/2 damage from normal weapons); <i>Very Attractive</i> (Charisma +4)				
Spells (30 Power Points): <i>Greater Healing</i> (10/20PP); <i>Draining Touch</i> (3PP); <i>Armor</i> (2PP); <i>Barrier</i> (1PP); <i>Bolt</i> (2PP; 3d6 damage); <i>Boost Trait</i> (2PP)				

Complications & Twists:

- If Lustriel has already been dealt with, Farkinwald will have a new plaything.

Number of Exits: 2

Rewards: None, apart from the gifts Lustriel may bestow.

Wheel of Fortune

Listen: You hear nothing.

A large wheel divided into twelve colorful segments hangs from one wall of this room. It looks as if it could be set to spinning with the slightest tug.

Someone with a high *Gambling* skill can attempt to "finesse" the wheel to get a desired result. On a *Success* they can bump the wheel's result up or down by one point; on a *Raise* they can bump it by up to 2 positions. If they *Fail*, the Wheel comes up Black. Each successive *Gambling* check incurs a cumulative -1 penalty (Lady Luck doesn't smile forever).

Die Roll	Color	Result
1	Black	The spinner of the wheel suffers a sudden heart attack. Pass a <i>Vigor -4</i> check or die.
2	White	The temperature in the room rises noticeably. It will continue to rise by 10 degrees every time the wheel is spun until a "Gold" result is rolled. After 5 spins the room will be uncomfortably warm. After 10 spins everyone will gain a <i>Fatigue</i> level. After 15 spins everyone will have to leave the room or risk death.
3	Red	A burning ray of fire shoots from the center of the wheel and sweeps the room. Everyone must make an <i>Agility -2</i> check or suffer 2d10 points of fire damage.
4	Blue	A pulse of blue light emanates from the wheel. It drains 1d6 Power Points from everyone in the room.
5	Yellow	The spinner is surrounded by a radiant aura that generates magical light over a Medium Blast Template radius. Anyone who strikes the aura must succeed a <i>Smarts -2</i> check or become <i>Shaken</i> by a flash of light. The aura lasts for 1d6 hours.
6	Green	A beam of green energy zaps the spinner, healing 1 <i>Wound</i> .
7	Purple	The spinner is struck by a purple beam of energy and gains the power of <i>Ultravision</i> for the rest of the adventure. With <i>Ultravision</i> you can see in absolute darkness, see invisible beings and see through illusions.
8	Orange	Hidden nozzles spray lamp oil on everyone. Soaked characters will immediately combust if exposed to flame.
9	Indigo	The spinner is surrounded by an indigo aura that drains 2 Experience Points. This cannot cause the loss of an <i>Advance</i> or a <i>Rank</i> but it makes it harder to reach the next level.
10	Copper	A bell sounds and 1d4x10 gold coins rain down from the ceiling
11	Silver	A bell sounds and 1d10 semi-precious stones rain down from the ceiling. Each is valued at 1d4x10 gold pieces.
12	Gold	You hear a loud <i>*Click!*</i> and the door at the far side of the room swings open

Complications & Twists:

- Change the results of the wheel

Number of Exits: 2. The other exit will not open until someone spins a "Gold" result on the Wheel.

Rewards: Nothing beyond what can be won from the Wheel.

The Watchers

Listen: You hear nothing.

Six large, ominous looking gargoyle statues crouch along the sides of this room. Their eyes gleam with magical energy, leading you to doubt that they are truly as inanimate as they appear to be.

Stealth is required to pass through this room without incident. Characters who attempt to pass the gargoyle statues must make a *Stealth* roll opposed against each gargoyle's *Notice* roll; if they fail the gargoyle fires a magical eye beam at them. The gargoyles have a *Notice* skill of d12.

Alternatively, characters can attempt to climb over the gargoyle statues by making a *Climb* check for each one. Gargoyles are unable to see adventurers that climb over them.

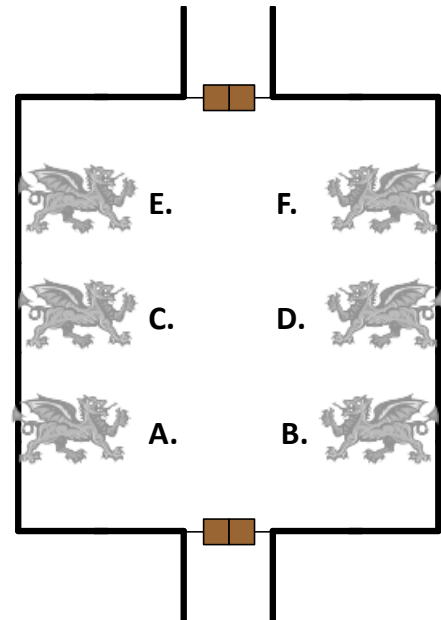

Statue	Effect
A	<i>Heat Ray:</i> Burns the target for 2d6 points of fire damage
B	<i>Force Ray:</i> Pummels the target for 2d6 points of force damage
C	<i>Polymorph Ray:</i> Target must make a <i>Vigor</i> -2 roll or be polymorphed into another creature for 1d6 hours
D	<i>Petrify Ray:</i> Target must make a <i>Vigor</i> -2 check or be turned to stone (permanently)
E	<i>Teleport Ray:</i> Target is teleported back to the front of the room
F	<i>Disintegrate Ray:</i> Target must make a <i>Vigor</i> -2 check or be disintegrated; characters that pass the check still sustain 2d10 points of damage.

Complications & Twists:

- Change the effects of the eye beams

Number of Exits: 2

Rewards: None

Chamber of Eternal Darkness

Listen: You hear nothing.

This room is completely pitch black. No torchlight is able to penetrate this unnatural darkness.

Any light source that is brought into this room (magical or otherwise) is permanently extinguished. Night vision and *Ultravision* still work normally. Characters who lack night vision capabilities suffer a -4 penalty to all rolls while they remain in pitch darkness.

The *Grues* will hang back against the far wall and watch the party fumble around in the dark a bit before ganging up on weak-looking targets.

Complications & Twists:

- Replace the *Grues* with *Shadow Beasts*

Number of Exits: 2. The only other exit from this room is a hole in the floor that drops you 10' to a hallway below.

Rewards: None

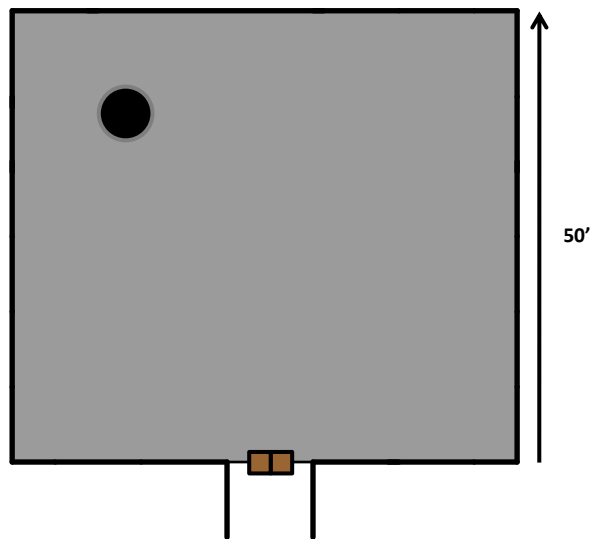

Grue (4)				
Strength: d10	Smarts: d6	Agility: d8	Spirit: d10	Vigor: d10
Pace: 6	Parry: 6	Toughness: 7	Fighting: d8	
Gear & Weapons: Claw/Bite (STR +d6)				
Edges & Powers: <i>Infravision</i> (can see in the dark); <i>Weakness: Light</i> (Grues run in fear from light; sunlight inflicts 2d8 points of damage per round); <i>Level Headed</i> (acts on best of 2 initiative cards); <i>No Infravision</i> signature (cannot be seen by <i>Night Vision</i>)				

Wind Tunnel

Listen: You hear nothing.

The door opens to reveal an 80' long, 10' wide hallway. At the end of the hall that is closest to you see a giant-sized carving of a man's face. The man has long, wild hair and his cheeks are puffed out as if he is frozen in the act of blowing. At the other end of the hall, you see a 3' wide hole in the wall surrounded by sharp yard long spikes.

As soon as anyone steps into the hallway, a tremendous gale of wind blows from the mouth of the carved face and sweeps the character off their feet toward the spikes at the end of the hall. The character must succeed an *Agility* -2 check to try and fit through the hole at the end of the hall. If they fail, they sustain 4d6 points of impalement damage. Characters that survive impalement can crawl safely through the hole.

Complications & Twists:

- None

Number of Exits: 2. This is a one-way room; the wind is so strong you cannot return the way you came.

Rewards: None

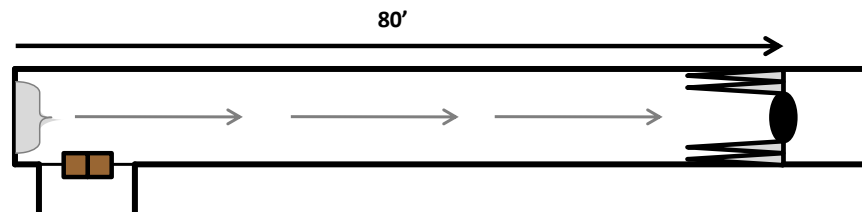

Chamber of Discs

Listen: You hear nothing.

The floor of this long chamber is filled with sharp spikes that are coated with some sort of oily resin. A small ledge projects out from the doorway; at foot-level you see a number of yard-wide discs of glowing pink energy floating in mid-air. Across the room you see six small imp-like beings on discs of their own. They laugh mockingly at you and spread out in a wide formation.

The party must ride on the discs to reach the other side of the room. The discs are powered by mental energy; a Disc Rider needs to make a *Smarts* check in order to move. The Disc Rider's *Pace* is equal to their *Smarts* die. Disc Riders suffer a multi-action penalty if they try to attack and make a *Smarts* check in the same round.

Tip: use a six-sided die to represent the altitude of each combatant in this room. Remember that characters with a higher altitude gain a +1 bonus to *Fighting* rolls against lower altitude targets.

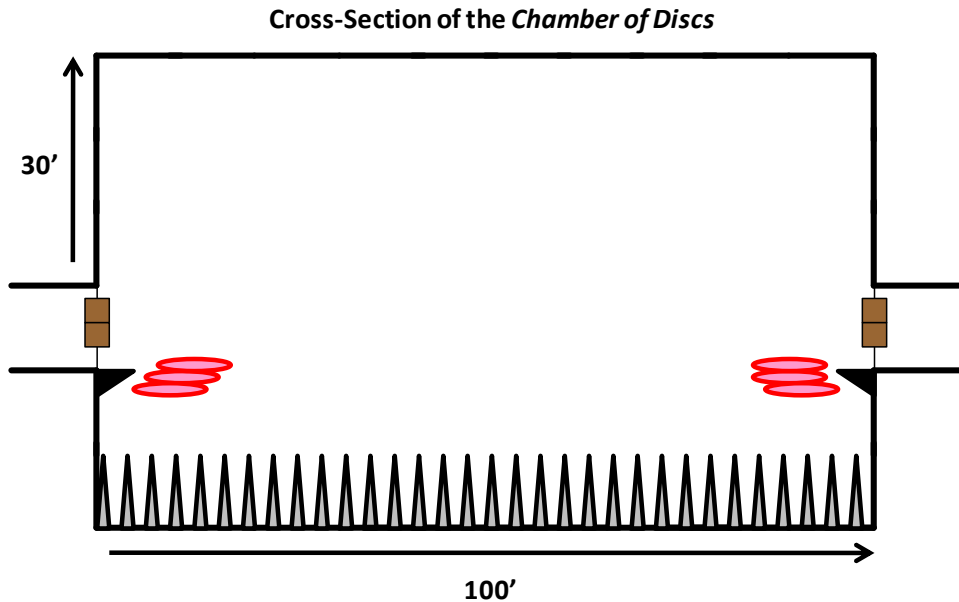

Every time a Disc Rider is *Shaken*, they must make an *Agility* check to remain standing on their disc. Those who fail take 1d6 points of falling damage for every 10' they fall and take an additional 2d6 points of damage from the spikes. Riders who take damage from the spikes must succeed a *Vigor* -2 check or suffer a *Wound* from the poison.

Complications & Twists:

- None

Number of Exits: 2

Rewards: None

Imps (6)

Strength: d4	Smarts: d8	Agility: d10	Spirit: d6	Vigor: d6
Pace: 6	Parry: 6(4)	Toughness: 4	Fighting: d4	Shooting: d8
Gear & Weapons: Short Bow (2d4 damage; 10/20/40 range)				
Edges & Powers: <i>Infravision</i> (can see in the dark); <i>Small</i> (+1 to <i>Dodge</i>); <i>Dodge</i> (+1 to <i>Dodge</i>); <i>Demon</i> (+2 to recover from <i>Shaken</i> ; immune to disease and poison; 1/2 damage from normal weapons)				

Poison Gas Chamber

Listen (-2): You hear a sibilant hissing sound.

As you open the door unhealthy looking green vapors seep into the hallway. The gas has a strong chemical smell that makes your nostrils burn and is as thick as proverbial pea soup. You can't see more than 5' into the room beyond.

This room is full of perpetually refreshing chlorine gas. Anyone who inhales the gas must make a *Vigor -2* check or suffer 2d10 points of poison damage. Characters can hold their breath for $1/2$ *Vigor* + 2 rounds to resist the effects of the chlorine

The only other exit from this room is a trap-door in the ceiling. It can be reached by someone who can vertically jump 10'.

For every 10 rounds that the party spends searching this room, make a *Wandering Monster* check.

Complications & Twists:

- Replace the chlorine gas with some other type of gas

Number of Exits: 2.

Rewards: None

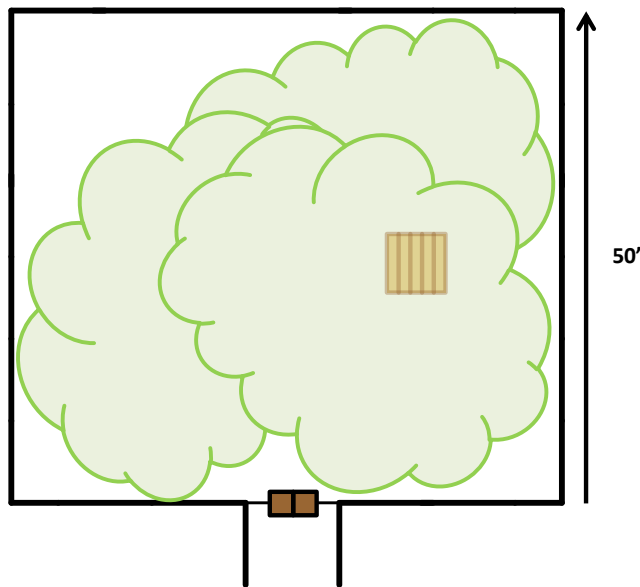

Blazing Inferno

Listen: You hear nothing. And feel nothing.

This entire room is filled with crackling flames. The heat rising off of them nearly singes your eyebrows. You think you spy another door on the other side of the inferno.

The flames are entirely illusory. Characters who successfully disbelieve them can move through them without harm. Characters who believe they are real will suffer 2d6 points of psychosomatic damage per round of exposure and will suffer *Fatigue* levels instead of *Wounds*.

Complications & Twists:

- Replace the flames with *Coldfire* -- blue and purple flames that inflict 2d6 points of cold damage

Number of Exits: 2

Rewards: None

The Freezer

Listen: You hear nothing but the door is extremely cold to the touch.

It takes some work to get this door open but when you do you see the walls and floor are covered with a prodigious layer of ice. Mixed in with icicles as thick as your wrist, you can see the distinctive forms of frozen humanoids. The room's other exit is similarly buried under inches of hard frost.

After spending 3 rounds in this room, characters must start making *Vigor* checks to avoid gaining *Fatigue* levels. Characters who take precautions against the cold can avoid this.

Chipping through the ice requires an attack roll. Thick ice has a *Toughness* of 8.

Complications & Twists:

- Raise the ceiling by 20' and put a *Frost Giant* in here

*Number of Exits:*2

Rewards: One of the frozen humanoids is wearing a *Ring of Fire Resistance*

The Door Golem

Listen: You hear nothing.

The key element in this otherwise bare room is a strange looking door. Or rather, it should be said a door looking strangely at you, for it seems to have a broad –featured face carved upon its woodwork. The door glares at you with black eyes and growls, “Go away! You don’t have permission to pass here!”

The door is obstinate and will only open if defeated in battle, *Intimidated* or *Taunted*. Any *Intimidate* or *Taunt* check that succeeds with a *Raise* causes the door to open.

Complications & Twists:

- The *Door Golem* has been replaced by an *Adamantine Door Golem* with an *Armor* value of +8

Number of Exits: 2. The only other exit is past the Door Golem. The Door Golem actually has a face on both sides of the door and will have to be defeated if anyone wishes to pass it a second time.

Rewards: None

The Door Golem (WC)				
Strength: d12+2	Smarts: d6	Agility: d6	Spirit: d8	Vigor: d12
Pace: 0	Parry: 7	Toughness: 12(9)	Fighting: d10	
Gear & Weapons: Bash (STR+d6)				
Edges & Powers: <i>Armor</i> +3; <i>Construct</i> (+2 to recover from <i>Shaken</i> ; immune to called shots, disease and poison; 1/2 damage from piercing); cannot move; <i>Improved Arcane Resistance</i> (+4 <i>Toughness</i> vs. Magic); <i>Paralyzing Touch</i> (+2 to hit; make a <i>Vigor</i> -2 check or be immobilized for 3 rounds)				

Murder Holes

Listen (-4): You hear the faint sounds of talking.

The door opens into the basement level of a tower. A spiral staircase ascends about 40' to a trap door far above. There appears to be no other way out of this room.

As soon as a character mounts the stairs, the hobgoblin guardsmen manning the tower will open several murder holes in the ceiling and begin raining counter-measures down on the party. The hobgoblins hurl a combination of caltrops, lamp oil and flaming arrows.

Caltrops reduce the victims *Pace* by 1 until they can be treated. Caltrop injuries are treated in the same manner that *Wounds* are.

The hobgoblins will bodily hold the trap door shut. To open the trap door an opposed *Strength* roll will need to be made but the hobgoblins will receive a +4 bonus to this roll.

Inside the tower the party finds some basic supplies including ammunition and rations.

Complications & Twists:

- None

Number of Exits: 2. The other exit is located at the top of the tower.

Rewards: Each hobgoblin has 1d6+1 gold pieces

Hobgoblin (4)				
Strength: d8	Smarts: d6	Agility: d6	Spirit: d10	Vigor: d8
Pace: 6	Parry: 7(6)	Toughness: 8(6)	Fighting: d8	
Gear & Weapons: Falchion (STR + d8); Splint Armor (Armor +2); Normal Shield (Parry +1); Heavy Bow (10/20/40 Range; 2d6+1 damage)				
Edges & Powers: <i>Infravision</i> (can see in the dark)				

The Downward Spiral

Listen: You hear nothing.

The door opens at the top of a spiral staircase that descends into darkness. You cannot tell how far the stairs go.

The stairs go down for 40' before stopping at a landing with a door. The *Shadow Beasts* will attack the party as they descend the stairs focusing their attentions on any characters holding light sources. Lurking at the bottom of the stairs are the *Grues*.

Complications & Twists:

- None

Number of Exits: 2

Rewards: None

Grue (2)				
Strength: d10	Smarts: d6	Agility: d8	Spirit: d10	Vigor: d10
Pace: 6	Parry: 6	Toughness: 7	Fighting: d8	
Gear & Weapons: Claw/Bite (STR +d6)				
Edges & Powers: <i>Infravision</i> (can see in the dark); <i>Weakness: Light</i> (Grues run in fear from light; sunlight inflicts 2d8 points of damage per round); <i>Level Headed</i> (acts on best of 2 initiative cards); No <i>Infravision</i> signature (cannot be seen by <i>Night Vision</i>)				

Shadow Beasts (2)				
Strength: NA	Smarts: d6	Agility: d10	Spirit: d10	Vigor: d10
Pace: 10	Parry: 5	Toughness: 7	Fighting: d6	
Gear & Weapons: None				
Edges & Powers: <i>Drain Life</i> (+2 to hit; make a <i>Vigor</i> -2 roll or lose one die of <i>Strength</i> and gain a <i>Fatigue</i> level); <i>Blend with Shadow</i> (can become invisible in any shadow); <i>Fleet Footed</i> (roll d10 when <i>Sprinting</i>); <i>Incorporeal</i> (can pass through solid objects; can only be hit by magic or magic weapons)				

The Proving Ground

Listen: You hear nothing.

This room smells like a mix of brimstone and ozone. Scorch marks and craters line the walls. A series of battered targets stand against the far wall of the room. They show evidence of being pounded by explosives. To your right you can see a number of arrow slits incised into the wall. From behind them you can hear the sounds of chittering, excited voices.

There are four kobolds holed up in a secured room from which they can fire magic wands at the party through the arrow slits. The secret door leading to this area can be found with a *Notice -4* check.

The kobolds are armed with the following wands:

- *Wand of Mini-Fireballs (22 Charges):* 12/24/48 Range; inflicts 2d6 points of fire damage; can fire 3 shots per action.
- *Wand of Lightning Bolts (20 Charges):* 12/24/48 Range; inflicts 2d6 points of electricity damage (+1d6 vs. metal targets)
- *Wand of Acid Jet (12 Charges):* affects all targets in a 12 square line; inflicts 2d6 points of acid damage
- *Wand of Ice Blast (20 Charges):* 12/24/48 Range; inflicts 2d6 points of cold damage to all targets in a Medium Blast Template area

Complications & Twists:

- None

Number of Exits: 2

Rewards: The four wands each have a few charges remaining on them.

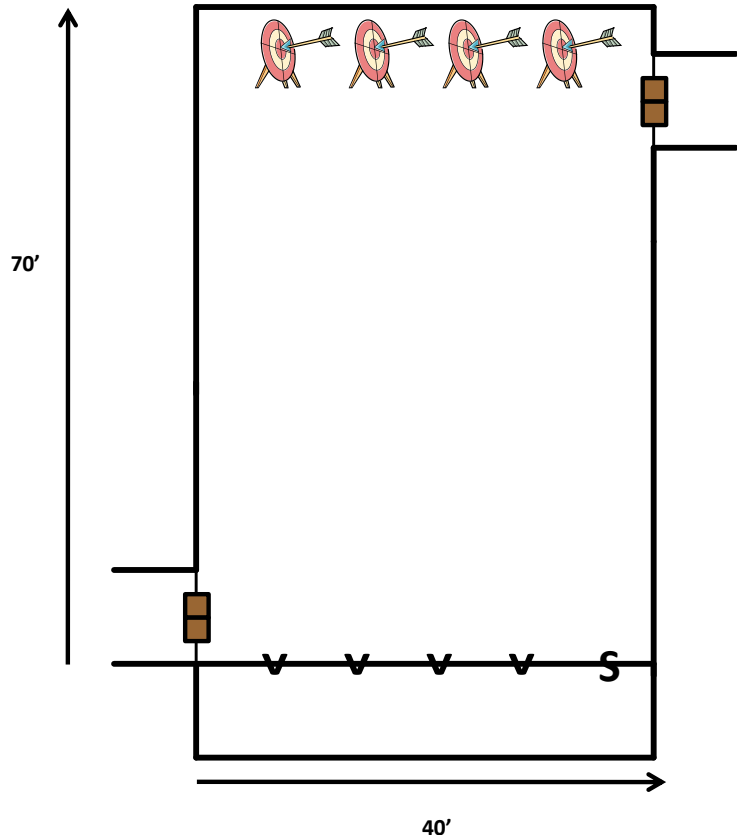

Kobolds (4)

Strength: d4	Smarts: d4	Agility: d10	Spirit: d6	Vigor: d6
Pace: 6	Parry: 4	Toughness: 4	Fighting: d4	Shooting: d8
Gear & Weapons: Short Bow (2d4 damage; 10/20/40 range); Javelin (STR+d4)				
Edges & Powers: <i>Infravision</i> (can see in the dark); <i>Sprint</i> (roll a d10 when <i>Sprinting</i>); <i>Cunning</i> (+2 to all <i>Stealth</i> and <i>Taunt</i> rolls); <i>Cowardly</i> (will only fight while the odds are in their favor)				

Golem Boxing

Listen: You hear nothing.

The door opens to a 40' drop. Standing near the doorway is a 40' tall stone golem. Across the way is another equally tall golem with a small crew of kobolds standing on its head. You can see a collection of wooden levers and wheels embedded in the head of the golem before you, along with some leather safety restraints. Perhaps it is some sort of control mechanism?

Controlling the golem requires a *Piloting* skill roll. On a success you can move and perform a standard action with the golem. On a *Raise* the golem gains a +2 bonus to its rolls for that round. When a golem is *Shaken* or *Wounded* the pilot needs to make a *Piloting* check to recover.

Anyone on board a golem when it takes damage must pass an *Agility* check to avoid falling off. If the pilot is strapped in he can disregard this check.

Complications & Twists:

- None

Number of Exits: 2

Rewards: None

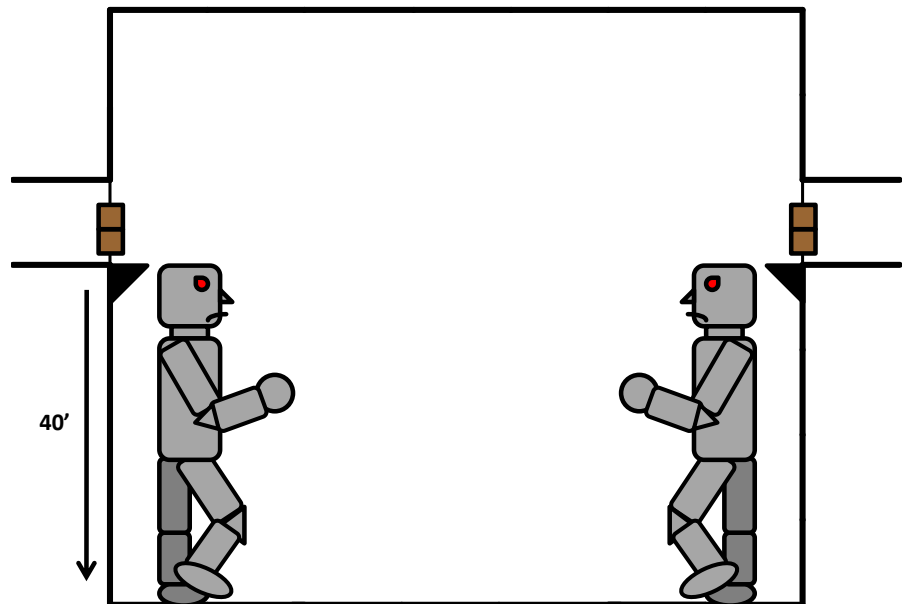

"The Pilot" Kobold (WC)

Strength: d4	Smarts: d4	Agility: d10	Spirit: d6	Vigor: d6
Pace: 6	Parry: 4	Toughness: 4	Fighting: d4	Piloting: d10
Gear & Weapons: Short Bow (2d4 damage; 10/20/40 range); Javelin (STR+d4)				
Edges & Powers: <i>Infravision</i> (can see in the dark); <i>Sprint</i> (roll a d10 when <i>Sprinting</i>); <i>Cunning</i> (+2 to all <i>Stealth</i> and <i>Taunt</i> rolls); <i>Cowardly</i> (will only fight while the odds are in their favor)				

Kobolds (4)

Strength: d4	Smarts: d4	Agility: d10	Spirit: d6	Vigor: d6
Pace: 6	Parry: 4	Toughness: 4	Fighting: d4	Shooting: d8
Gear & Weapons: Short Bow (2d4 damage; 10/20/40 range); Javelin (STR+d4)				
Edges & Powers: <i>Infravision</i> (can see in the dark); <i>Sprint</i> (roll a d10 when <i>Sprinting</i>); <i>Cunning</i> (+2 to all <i>Stealth</i> and <i>Taunt</i> rolls); <i>Cowardly</i> (will only fight while the odds are in their favor)				

The Infirmary

Listen: You hear nothing.

This room contains four clean beds and shelves holding an assortment of medicinal aids.

A cursory search of the shelves reveals a plentiful supply of bandages, three bottles of *Wine of Heroism* (+2 to recover from *Shaken* and ignore 1 point of *Wound* penalties for 6 rounds) and four jars of *Finbar's Ointment* (heal 1 *Wound* or ingest to cure *Poison* or *Disease*)

The party can pause here to take short breaks but if they try to sleep they will surely attract a Wandering Monster.

Complications & Twists:

- None. This room is actually safe.

Number of Exits: 4

Rewards: The healing potions and ointments can be taken from this room.

The Riddler

Listen: You hear nothing.

A large sphinx carved from red granite stands watch over the far side of this room. You can see no other exits. You hear a loud grinding sound as the sphinx turns its head to look at you.

Sample Riddles:

Riddle	Answer
What can bring back the dead; make us cry, make us laugh, make us young; born in an instant yet lasts a life time?	Memories
What can run but never walks, has a mouth but never talks, has a head but never weeps, has a bed but never sleeps?	A River
The Builder doesn't need me, the Buyer doesn't use me and the User never wants me. What am I?	A Coffin
Feed me and I live, but give me a drink and I die. What am I?	Fire
Poor men have me and rich men want me. What am I?	Nothing
Alive without breath, as cold as death; never thirsty, ever drinking, all in mail never clinking. What am I?	A Fish

Complications & Twists: None. The Sphinx should ask different riddles every time.

Number of Exits: 2. This is a one-way room; once the Sphinx is passed it moves to block the doorway again. It will only speak to people who approach it from the front.

Rewards: None.

The False Treasure Vault

Listen: You hear nothing.

A pile of glittery, tantalizing treasure lies just out of reach beyond an iron door. You can see a large pile of loose coins, several gemstones and a wooden chest.

The iron door is triple-locked and trapped. Each lock requires a *Lockpicking* -2 skill check to overcome. If any of the skill checks fail a poison needle trap is activated and the lock picker must succeed an *Agility* -2 check to avoid getting pricked. Victims of the trap need to pass a *Vigor* -2 check or die. If any *Lockpicking* check succeeds with a *Raise*, the trap is disarmed.

The pile of gold coins is actually a *Treasure Ooze* and the chest is a *Mimic*. They will wait until the party is very close before attacking.

Complications & Twists:

- None

*Number of Exits:*3

Rewards: 3d10x10 +100 gold coins and 1d4 gems valued at 250 g.p. can be harvested off the dead ooze.

Treasure Ooze				
Strength: d6	Smarts: d4(A)	Agility: d4	Spirit: d6	Vigor: d6
Pace: 2	Parry: 5	Toughness: 6	Fighting: d6	Stealth: d12
Gear & Weapons: None				
Edges & Powers: <i>Acidic Touch</i> (+2 to hit; 2d6 points of Acid damage; corrodes metal); <i>Paralyzing Touch</i> (+2 to hit; make a <i>Vigor</i> -2 check or become immobilized for 3 rounds); <i>Ooze</i> (+2 to recover from <i>Shaken</i>); immune to poison, disease, edged weapons, fire and cold; can squeeze through small openings); <i>Wall Walker</i>				

Mimic				
Strength: d8	Smarts: d6	Agility: d6	Spirit: d8	Vigor: d8
Pace: 4	Parry: 5	Toughness: 8(6)	Fighting: d6	
Gear & Weapons: Bash (STR)				
Edges & Powers: <i>Paralyzing Touch</i> (+2 to hit; make a <i>Vigor</i> -2 check or be immobilized for 3 rounds); <i>Superior Frenzy</i> (can make 3 attacks per round); <i>Armor +2</i> (Rubbery Body)				

The Anti-Magic Room

Listen: You hear nothing.

When you open the door to this room you notice some silver arcane lettering inscribed into the threshold of the doorway. You see nothing else within the room.

Anyone with *Knowledge: Arcane* can decipher the runes on the threshold which say, "DANGER: ANTI-MAGIC ZONE"

Spellcasting characters lose 1d6 Power Points for every round they spend in this room. This loss is accompanied by a sensation of acute illness.

Any *Magical Gear* that is brought into this room is temporarily suppressed and loses its magical abilities for 3 rounds per round of exposure. There is also a 10% chance per round that each item becomes permanently disenchanting.

Complications & Twists:

- None

Number of Exits: 4

Rewards: None

Gates and Levers

Listen: You hear nothing.

This room is entirely divided into a series of 10' by 10' cells. Through the bars you can see a number of trapped minotaurs, snorting with rage. Each cell contains levers that appear to actuate portcullis gates. All the way on the other side of these cages you spy the room's other exit.

The arrows on the diagram below show the direction that the gates lead to. If the minotaurs start taking missile fire they will activate the gate levers themselves and begin pursuing the party.

Complications & Twists:

- None

Number of Exits: 2. This is a one-way room; the gates will not permit you to backtrack the way you came.

Rewards: None

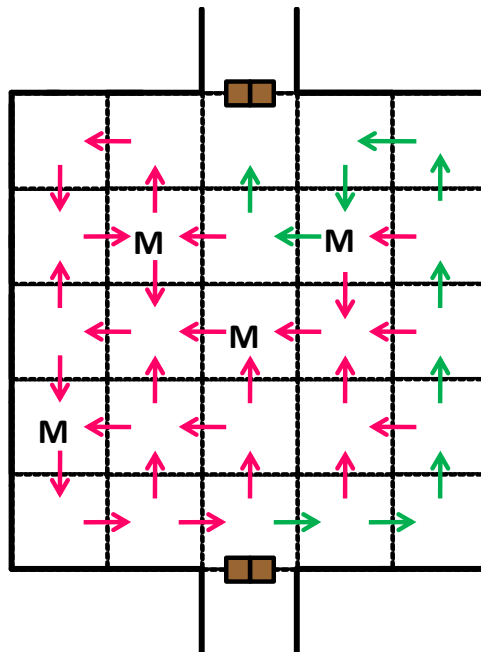

Minotaurs (4)

Strength: d12+2	Smarts: d6	Agility: d8	Spirit: d8	Vigor: d12
Pace: 8	Parry: 8	Toughness: 10	Fighting: d10	
Gear & Weapons: Bash (STR)				
Edges & Powers: <i>Fleet Footed</i> (rolls a d10 when <i>Sprinting</i>); +1 <i>Reach</i> ; <i>Gore</i> (if the Minotaur moves its full <i>Pace</i> before attacking it can inflict +4 Damage)				

The Flood

Listen: You hear nothing.

This room has every appearance of being empty. Four evenly spaced doors lead out in all cardinal directions.

In the event that anyone checks, the doors labeled "A" are damp and cold to the touch. If any of them are opened, the entrance door will slam shut and bar itself at the same moment that a violent torrent of water is unleashed into the room. This torrent knocks over all characters in a Cone Template area, causing them to be *Shaken*, and proceeds to fill the room with water at a rate of 5' per round. In 2 rounds the room is entirely filled.

Characters can hold their breath for $1/2$ *Vigor* + 2 rounds and will need to use their *Swimming* skill to reach an exit.

Complications & Twists:

- Add some aquatic monsters to this room, such as *Water Elementals* or *Merlings*

Number of Exits: 4

Rewards: None

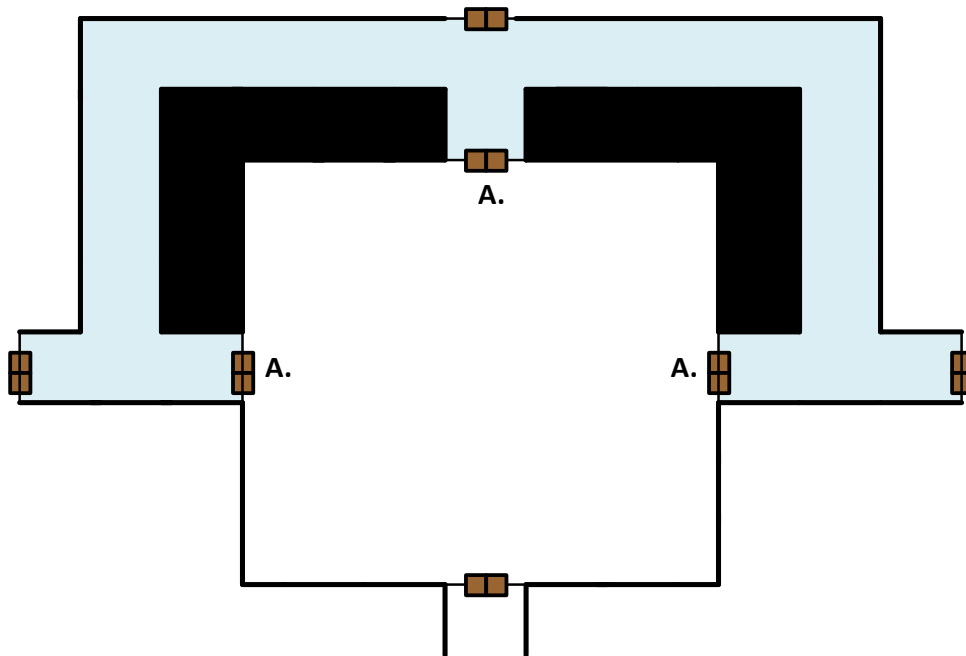

The Blender

Listen: You hear clicking, snapping and whirling sounds.

The entire room is filled with gleaming blades spinning in mid-air. To get to the exit on the other side you will need to carefully pick a path through this storm of razors. Off to one side of the room, you note what appears to be a badly slashed corpse lying against the wall.

Characters must make an *Agility* -2 check for each square they pass through in this room. If they fail they sustain 2d6 points of slashing damage. On a *Raise* the character is able to tumble through two squares instead of one. If a character rolls a *Critical Failure* (a natural 1 on both their trait and wild card die) they suffer 3d6 points of damage.

If a character casts *Dispel* they can neutralize a single square of blades (a 5' by 5' area), rendering them inert.

Complications & Twists:

- None

Number of Exits: 3

Rewards: If the body in the corner is examined the searcher recovers a slightly nicked *Short Sword* +1.

Courtyard of the Damned

Listen: You hear nothing.

The door opens upon a large courtyard filled with clinging mists. A skeletal warrior holding a glowing axe stands at the far end of the yard. At its command, a number of fresh corpses and bleached skeletons shamble to their feet

The undead shamble toward the party and attack immediately. They will take no prisoners.

Climbing Out:

Characters who wish to scale the 50' high walls can climb out of Castle Farkinwald. They'll find themselves somewhere within the grounds of the castle and will need to scale another 100' high wall to truly break free (since all of the gateways are underground). It is impossible to gain access to any other rooms of the castle by climbing out of this room -- from the outside the buildings of the castle are just windowless, door-less stone slabs for as far as the eye can see.

Complications & Twists:

- Substitute another type of undead creature for the *Skeleton Captain*.

Number of Exits: 2

Rewards: The *Skeleton Captain* is holding a +1 *Battle Axe*.

Zombies (10)				
Strength: d6	Smarts: d4	Agility: d6	Spirit: d4	Vigor: d6
Pace: 4	Parry: 5	Toughness: 7	Fighting: d6	
Gear & Weapons: Bash (STR)				
Edges & Powers: <i>Undead</i> (+2 to recover from <i>Shaken</i> ; +2 <i>Toughness</i>); <i>Weakness: Head Shots</i> (a called shot to the head inflicts +2 damage); <i>Fearless</i> ; cannot <i>Sprint</i>				

Skeletons (15)				
Strength: d6	Smarts: d4	Agility: d8	Spirit: d4	Vigor: d6
Pace: 7	Parry: 5	Toughness: 7	Fighting: d6	
Gear & Weapons: Bash (STR)				
Edges & Powers: <i>Undead</i> (+2 to recover from <i>Shaken</i> ; +2 <i>Toughness</i> ; immune to called shots)				

Skeleton Captain (WC)				
Strength: d8	Smarts: d4	Agility: d8	Spirit: d4	Vigor: d8
Pace: 7	Parry: 7	Toughness: 8	Fighting: d8+1	
Gear & Weapons: +1 <i>Battle Axe</i> (STR + d8 + 1)				
Edges & Powers: <i>Undead</i> (+2 to recover from <i>Shaken</i> ; +2 <i>Toughness</i> ; immune to called shots); <i>Block</i>				

Hall of Archers

Listen: You hear nothing.

The end of this long, narrow hall is barricaded by stone blocks, barrels and planks of wood. Behind this obstacle are two ranks of hobgoblin archers. They immediately fire warning shots.

The archers have more than enough ammunition (about 200 arrows) and will not waste it in a lost cause. The barricade has a *Toughness* of 10 and can be easily mounted. It provides a +1 *Cover* bonus to the archers.

Complications & Twists:

- None

Number of Exits: 2

Rewards: Each archer has 1d6+1 gold pieces

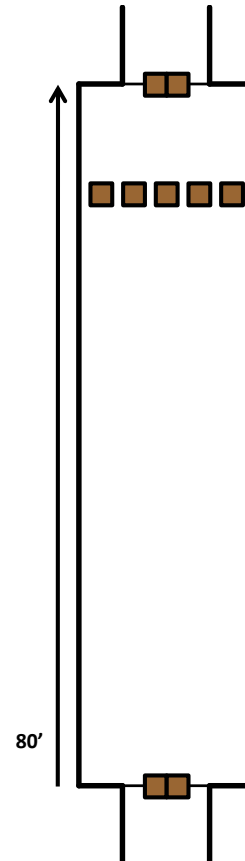

Hobgoblins (6)				
Strength: d8	Smarts: d6	Agility: d6	Spirit: d10	Vigor: d8
Pace: 6	Parry: 7(6)	Toughness: 8(6)	Fighting: d8	
Gear & Weapons: Falchion (STR + d8); Splint Armor (Armor +2); Normal Shield (Parry +1); Heavy Bow (10/20/40 Range; 2d6+1 damage)				
Edges & Powers: <i>Infravision</i> (can see in the dark)				

Hall of Illusions

Listen: You hear nothing.

Draw a random encounter from the deck and read the description to the party. This is the illusion that The Spinner is projecting.

This whole tableau is an elaborate illusion created by The Spinner, a powerful Archanid Illusionist. The Spinner will wait for the adventurers to begin interacting with the illusory room before attempting to snare people in its *Web Blast*. It will use *Phantasmal Nemesis* on tough looking characters.

Characters can attempt to disbelieve the Spinner's illusion by making a *Smarts* check opposed against its *Spellcasting* rating.

Complications & Twists:

- None

Number of Exits: 3

Rewards: None

"The Spinner", Archanid (WC)				
Strength: d10	Smarts: d12	Agility: d10	Spirit: d8	Vigor: d8
Pace: 6	Parry: 7	Toughness: 6	Fighting: d10	Spellcasting: d12
Gear & Weapons: Bite (STR + d6)				
Edges & Powers: <i>Poison</i> (targets that are bitten must make a <i>Vigor</i> -2 check or suffer 2d10 points of Acid damage); <i>Web Blast</i> (3/6/12 Range; Small Blast Template AoE; webbed targets are immobilized and make all rolls at -4; webs have a <i>Toughness</i> of 7); <i>Wall Walker</i>				
Spells (20 Power Points): <i>Phantasm</i> (4), <i>Puppet</i> (3), <i>Phantasmal Nemesis</i> (5), <i>Fear</i> (2), <i>Invisibility</i> (5)				

The *Phantasmal Nemesis* spell has the following statistics:

Phantasmal Nemesis

Power Points: 5

Range: *Smarts*

Duration: 3 (2/round)

The target is confronted with an image of their worst nightmare. They must make an opposed roll every round (their *Smarts* vs. the caster's *Spellcasting*) or become *Shaken*. If the target is already *Shaken*, they must make a *Smarts* check. If they fail they gain 1 *Fatigue* level of psychosomatic damage. If the target wins the opposed roll with a raise, they break the illusion.

The Beer Cellar

Listen (-2): You hear a belching sound.

You see a strange creature leaning up against one of the kegs in the far corner of the room. At first you think it's a statue but then you realize that it has stone skin and small horns like a gargoyle. The creature stands about five feet tall and has a blade as long as it is tall slung across its back. As you enter, the creature takes a pull off a tankard of ale, belches softly and says in a gravelly voice, "So you've come down for a bit o' the Private Reserve too, eh? You know any drinking songs?"

If spoken to, the creature identifies itself as "Shagrat the Rock Demon". He announces that he's currently off-duty but if no one will share a drink with him, he'll have to get back to work (meaning he'll have to attack the party). Shagrat challenges anyone who will drink to a contest: if you can put down more ale than he can, he'll let you skate on past and pretend he didn't see you.

For each beer consumed beyond the first one, a drinker must make a *Guts* check with a cumulative -1 penalty per beer or become sick. The first drinker to succumb loses the contest. *Example:* Collin drinks his fourth beer, he needs to pass a *Guts* -3 check to remain standing.

Shagrat will join up with the party if someone can produce a beverage more interesting than the ale in Farkinwald's cellar.

# of Beers	Effect
1	Tastes great!
2	You feel a buzz coming on
3	You are lightly toasted. Suffer a -1 penalty to all rolls for the next 1d6 hours
4	Gain <i>Arcane Resistance</i> until you go to sleep
5	You are pretty friggin' smashed. Suffer a -2 penalty to all rolls for the next 2d6 hours.
6+	Gain the <i>Juggernaut</i> Edge until you go to sleep (you are able to sustain one more <i>Wound</i> than normal before becoming <i>Incapacitated</i>).

Complications & Twists:

- None

Number of Exits: 3

Rewards: None

The Tumbler

Listen: You hear nothing.

This room has every appearance of being empty. Four evenly spaced doors lead out in all cardinal directions.

Once 600 pounds of weight is placed on the floor of this room, it violently tilts on its axis dumping all of the room's occupants for 2d6 points of falling damage. The room is now on its side; the exits are on the ceiling and in the middle of both walls. Characters will need to climb to reach the doorways out of here.

Complications & Twists:

- None

Number of Exits: 3. This is a one-way room; once the room tips over, you cannot exit via the door you entered through.

Rewards: None

Hall of Chains

Listen: You hear nothing.

The floor of this room plunges away into darkness. Hanging from the ceiling at 5' intervals are lengths of chain. Three twisted looking individuals bound in skin-tight leather stand supported by the chains, as if they were docile snakes. Their flesh appears to have been scarred and mortified by sharp blades – not unlike the ones they wield in their pale hands.

Characters will need to climb on the chains to make it to the room's other exits. A simple *Climb* check allows a character to swing from chain to chain at their *Pace*. If a character attempts to *Climb* and perform some other action in the same round, they will suffer a multi-action penalty.

Cenobites do not need to make *Climb* checks to move amongst the chains. Their latent telekinesis supports them.

Any character hanging from a chain that is *Shaken* or *Wounded* must make a *Climb* -2 check to maintain their grip.

Those unfortunate enough to fall from the chains suffer 10d6 points of falling damage.

Complications & Twists:

- Characters who fall into the abyssal darkness are transported to the Prison Plane that the Cenobites originate from. Victims are jailed in geometric prisons until the Cenobites come to torture them... But that's an adventure for another day.

Number of Exits: 3

Rewards: None

Cenobites (WC) (3)				
Strength: d8	Smarts: d12	Agility: d8	Spirit: d12	Vigor: d10
Pace: 6	Parry: 6	Toughness: 9 (7)	Fighting: d8	Guts: -2
Gear & Weapons: Blades (STR+d6); Spiked Leather (Armor +2); Spiked Chain (Reach +2; STR+d6 damage)				
Edges & Powers: <i>Pleasure in Pain</i> (<i>Wound</i> penalties provide bonuses instead); <i>Fear Aura</i> (when someone sees a Cenobite for the first time they must succeed a <i>Guts</i> -2 check or become <i>Shaken</i>); <i>Weakness: Holy Damage</i> (Holy Weapons inflict an extra 1d6 damage); <i>Demon</i> (+2 to recover from <i>Shaken</i> ; immune to disease and poison; 1/2 damage from normal weapons)				

The Magic Cube

Listen: You hear nothing.

Floating in the center of this room is an engraved metallic cube about 2' by 2' in size. The top of the cube yawns open as if waiting for an object to be placed inside of it. You can see one other exit from this room.

The cube cannot be moved -- strong telekinetic energies hold it in place.

When an item is placed in the cube, the top flap closes and the cube hums for a moment before spinning in place wildly. Gradually the rotations decrease and then one of the side faces of the cube hinges open, revealing whatever product the cube managed to produce (see below):

Item placed in the cube...	Produces...
Common Miscellaneous Item (i.e. rope, torch, bedroll, etc.)	A different randomly determined Common Miscellaneous Item.
Coins	Cashes out gold for gems on a 100:1 basis. Any fractions of 100 are lost as a "transaction fee".
Potion	A potion with the opposite effect
Magic Item	Destroys the item and produces a <i>Magical Essence</i> . This glowing gemstone contains whatever enchantment the item held and can be used to create other Magic Items.
Gems	Cashes out multiple lower value gems for a single higher value gem
Item + Magical Essence	Item becomes enchanted by the Magical Essence. An item cannot hold more than one Magical Essence at a time.
A piece of Ammunition (i.e. arrow, bolt, throwing dagger, etc.)	1d20 more pieces of identical Ammunition
Magical Essence + Gem	The key to unlock the room's other exit
Anything Else	The item is returned unchanged

Complications & Twists:

- None

Number of Exits: 3

Rewards: None

Drowning Pool

Listen: You hear nothing.

The floor of this room is entirely obscured by green, algae-filled water. You have no way of knowing how deep the pool is.

Visibility in the pool is reduced to 5'.

The two valves in this room open and close the portcullis gates at locations "A" and "B". When gate "A" is open, gate "B" is closed and vice versa. If both valves are put in the open position both gates "A" and "B" will close but the secret door will open.

Complications & Twists:

- Add some aquatic monsters to the room, such as *Water Elementals* or *Giant Eels*.

Number of Exits: 2

Rewards: If the secret chamber is opened, the party finds the bleached remains of a *Merling* lying on a small pile of 99 gold pieces with a *+1 Spear* and a *Coral Helm* (grants a +2 bonus to all *Swimming* checks and allows the wearer to hold their breath for twice as long)

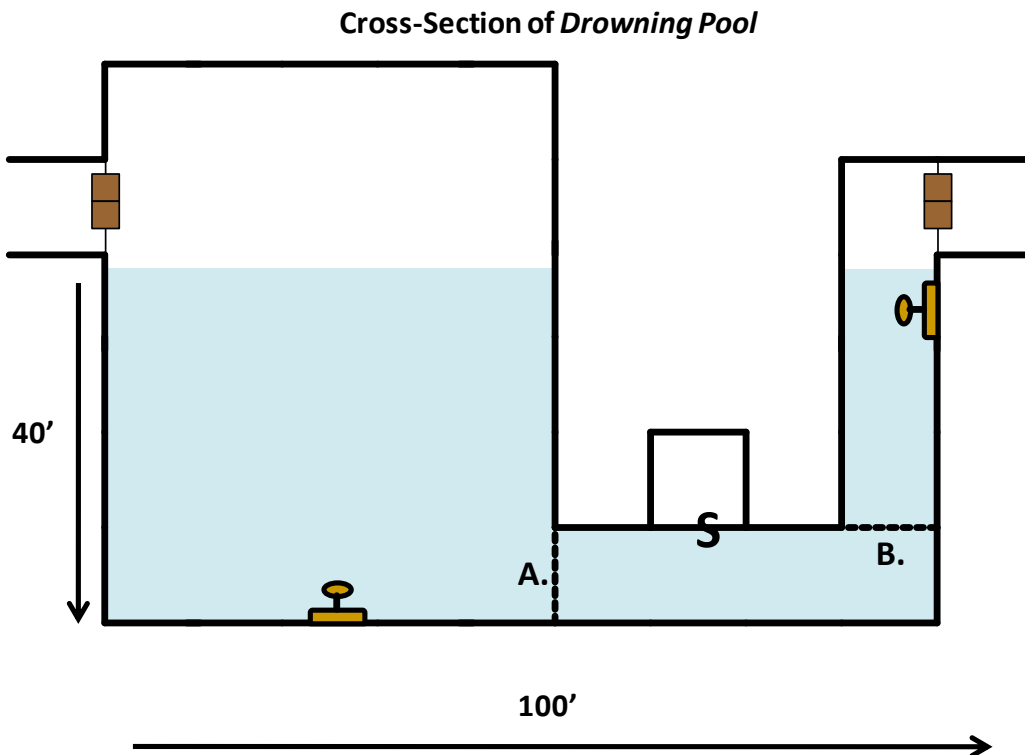

Slime Chamber

Listen: You hear what sounds like water droplets falling into a pool.

The entire walls, floor and ceiling of this room are covered with viscous green slime. There doesn't appear to be a way through the room that wouldn't involve getting slimed.

The green slime is your standard issue flesh-dissolving variety. It eats through leather and clothing in 1 round, metal in 3 rounds and inflicts 2d6 points of damage on contact with bare flesh. The slime will continue to dissolve flesh until it is treated. As it feeds the slime grows, inflicting an additional 1d6 points of damage every 3 rounds.

Due to the slipperiness of the slime, every time a character moves in the stuff they must make an *Agility* check at a cumulative -1 per square traveled beyond the first or fall prone.

The slime has a randomly determined weakness (determined below). When exposed to this weakness the slime is instantly destroyed:

Die Roll (d8)	Vulnerability
1	Fire
2	Cold
3	Electricity
4	Sonic
5	Alcohol
6	Water
7	Acid
8	Magic

Complications & Twists:

- The slime is actually a completely harmless type of mold. It has no effect beyond being slippery.
- The slime is harmless but produces an odor that is very attractive to Wandering Monsters. If anyone in the party gets coated in slime the party will be visited by a Wandering Monster in 2d6 rounds.

Number of Exits: 3

Rewards: It is possible to harvest the slime in a glass vessel if that's your thing.

The Stone Lady

Listen: You hear nothing but smell the distinct aroma of incense.

This candle-lit room is luxuriously decorated with heavy embroidered curtains, thick rugs and tapestries. Censers of burning incense stand in the corners of the room. A stone plinth occupies the center of the chamber; upon it lies an exquisitely carved statue of a strapping woman armed and armored like a warrior. The detail is truly remarkable; whoever carved her was surely a master.

The "statue" is actually the petrified body of Princess Kaizarine Nicendra, an adventuress that Farkinwald took a fancy to. When she refused his offer to become one of his paramours, he turned her to stone and placed her here

If Kaizarine is revived she will generously reward her rescuers (see *Rewards* below). If she is murdered for her gear word will eventually get back to her family who will place a sizeable bounty on the party's head. Reports of anyone not named Kaizarine carrying the Nicendra family sword will travel quickly.

Complications & Twists:

- Kaizarine is actually a vampire
- Kaizarine is actually a *friendly* vampire
- If Kaizarine has already been rescued then she will be replaced with Farkinwald's latest reluctant flame (one of the party members perhaps?)

Number of Exits: 4

Rewards: If Kaizarine is rescued and survives the adventure she will see to it that her rescuers are amply rewarded. The party members will be knighted in her home country and given lands to collect incomes from.

Princess Kaizarine Nicendra (WC)

Strength: d10	Smarts: d6	Agility: d8	Spirit: d10	Vigor: d10
Pace: 6	Parry: 8	Toughness: 9(7)	Fighting: d10+2	Charisma: +4
Gear & Weapons: <i>Bastard Sword</i> +2 (STR + d8 + 3); <i>White Dragon Scale Mail</i> (Armor +2; 1/2 damage from Cold)				
Edges & Powers: <i>Block</i> (+1 Parry); <i>Noble</i> ; <i>Frenzy</i> (can make 2 attacks per round at a -2); <i>Level Headed</i> (can act on best of 2 Initiative cards)				

The Magma Cave

Listen: The door is hot to the touch.

The floor of this room has fallen away into a pool of hot magma about 40-50' below you. Only a few resolute pillars of stone remain, creating a precarious pathway between where you're standing and the exit on the other side of the room.

The party will need to make *Strength* checks to jump from pillar to pillar. A character can normally jump about 10' with an additional 5' per *Raise*. Attempting to land on a smaller pillar will also require an *Agility* check

While the party leaps, *Fire Elementals* will take pot shots from below. They hurl *Fireballs* that explode over a Medium Blast Template area for 2d6 points of fire damage. This is mainly to discourage the party from bunching up on a pillar.

Anyone who falls in the lava suffers 3d10 points of fire damage per round.

Complications & Twists:

- None

Number of Exits: 2

Rewards: None

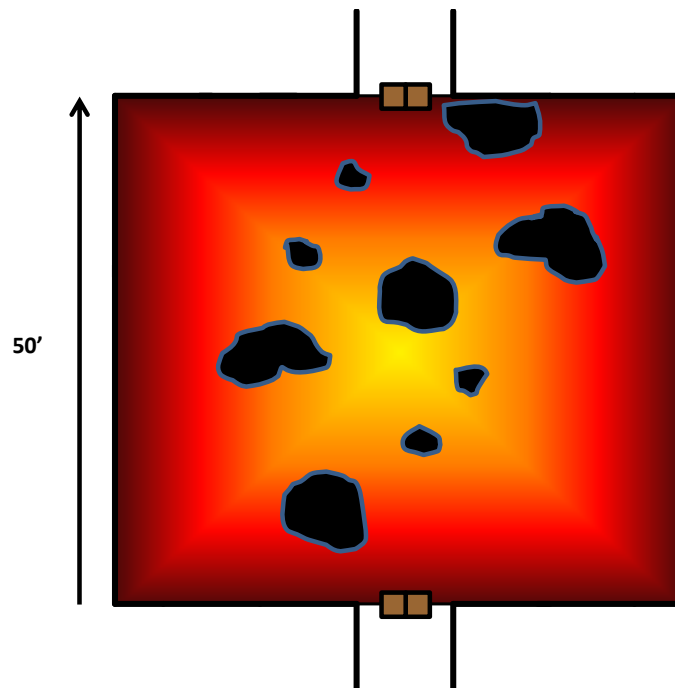

The Crystal Chamber

Listen: You hear nothing.

The walls, floor and ceiling of this room are made entirely of faceted crystal. Torches placed in the room throw blinding reflections off of each facet, searing your eyes. You will need to protect your vision somehow if you go in there.

Characters who step into this room will become light blind. This has the same effect of being in *Dark* conditions (-2 to all rolls). If the characters do not take the appropriate precautions to protect their eyes they will be temporarily blinded for 1d6 hours.

The *Crystal Statues* will move in to attack once the party is all the way into the room.

Complications & Twists:

- None

*Number of Exits:*3

Rewards: None

Crystal Statues (4)

Strength: d10	Smarts: d4	Agility: d6	Spirit: d8	Vigor: d8
Pace: 4	Parry: 5	Toughness: 10 (6)	Fighting: d6	
Gear & Weapons: Bash (STR)				
Edges & Powers: <i>Armor +4; Construct (+2 to recover from Shaken; immune to called shots, disease and poison; 1/2 damage from piercing); cannot Sprint</i>				

Lord of Bones

Listen: You hear a clicking and clattering sound.

This room is occupied by an 8' tall, four-armed skeleton and six man-sized minions. In each of its bony hands the skeletal brute clutches a curved falchion.

The Lord of Bones and its minions rush to attack!

Complications & Twists:

- Replace the Bone Golem with a Skeleton Knight

Number of Exits: 3

Rewards: None

Bone Golem				
Strength: d8	Smarts: d4	Agility: d8	Spirit: d8	Vigor: d8
Pace: 8	Parry: 7	Toughness: 9(7)	Fighting: d10	
Gear & Weapons: Falchions (STR + d8)				
Edges & Powers: <i>Armor</i> +2; <i>Construct</i> (+2 to recover from <i>Shaken</i> ; immune to called shots, disease and poison; 1/2 damage from piercing); <i>Arcane Resistance</i> (+2 <i>Toughness</i> vs. Magic); <i>Multiple Limbs</i> (can make 4 melee attacks per round with no multi-action penalty); cannot <i>Sprint</i>				

Skeleton				
Strength: d6	Smarts: d4	Agility: d8	Spirit: d4	Vigor: d6
Pace: 7	Parry: 5	Toughness: 7	Fighting: d6	
Gear & Weapons: Bash (STR)				
Edges & Powers: <i>Undead</i> (+2 to recover from <i>Shaken</i> ; +2 <i>Toughness</i> ; immune to called shots)				

Slide Chamber

Listen: You hear nothing.

The floor of this room is steeply tri-sected by sheer slides that terminate in three man-sized holes. The slides are polished in such a way that you do not think you could climb back up if you fell down one.

It is possible to tip-toe between the slides to reach a particular floor hole. Once a character slides down a hole, they will be dropped down a 10' chute into a random room. Draw a random room from the *Encounter Deck* and attach it to any available place on the map. If no unexplored hallways are available, place the new room off on its own in some remote corner of the map. The character appears in the exact center of this room (or as near to this as is possible taking solid obstacles into account). If appearing in the center of the room would plunge the character into some immediate peril (such as, say, a vat of acid) then such is their fate.

Complications & Twists:

- None

Number of Exits: 4

Rewards: None

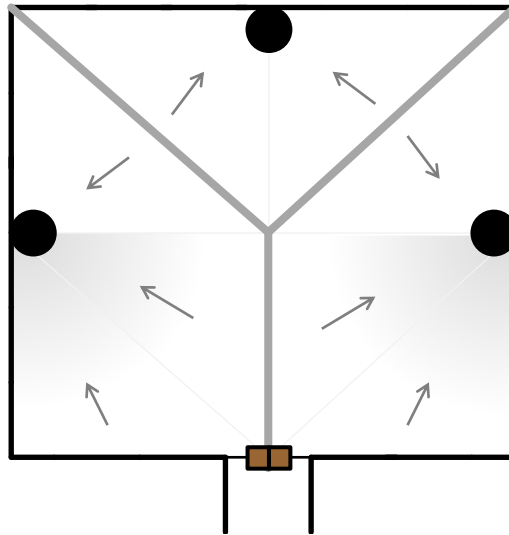

The Ascent

Listen: You hear nothing.

The ceiling of this room is about 50' high. Near the top of the far wall you can see a 10' by 10' opening that appears to lead to another hallway. You will need to scale the wall somehow to reach it. Blocky protrusions sticking out of the wall make the straight path seem to be the most challenging route to take.

Refer to the diagram below. Depending upon which route climbers take they will encounter different obstacles. For each *Climb* check that a climber makes, they can scale 30'.

If the climber treads upon one of the obstacles, use this table:

Obstacle	Effect
Climbing Block	This outcrop presents a challenge to even a skilled climber. Suffer a -4 penalty to your <i>Climb</i> check.
Slime Trap	A cascade of green slime falls on your head. It eats through leather and clothing in 1 round, metal in 3 rounds and inflicts 2d6 points of damage on contact with bare flesh. The slime will continue to dissolve flesh until it is scoured or burned. As it feeds the slime grows, inflicting an additional 1d6 points of damage every 3 rounds. The slime makes the wall slippery, imposing a -2 penalty on all <i>Climb</i> checks.
Air Trap	A sudden blast of air threatens to knock you off the wall. Make a <i>Strength</i> -2 check to hang on.
Oil Trap	Lamp oil sprays all over you making you highly combustible and imposing a -2 penalty on all <i>Climb</i> checks.
Fire Trap	A blast of fire burns you for 2d6 points of fire damage. If you are doused in oil you combust.

Complications & Twists:

- None

Number of Exits: 2

Rewards: None

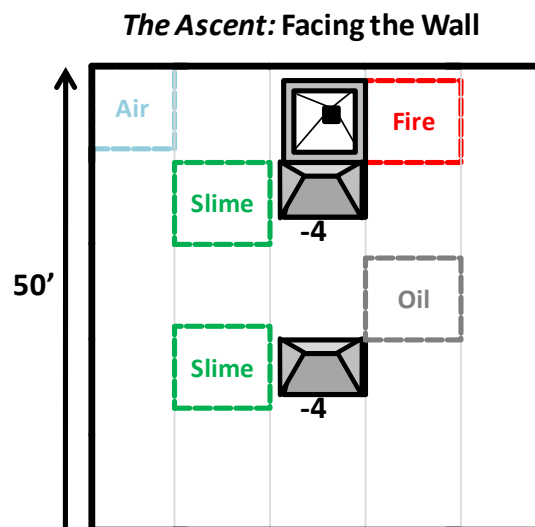

Chamber of Faces

Listen: You hear nothing.

The walls of this room are dominated by three giant-sized face carvings of a man, a dragon and a demon. The mouth of each gapes open slightly, revealing inky blackness within.

Offerings must be placed within the mouths of the face carvings to get them to react.

The Dragon Face: Dragons crave magic above all else. Placing a *Magic Item* in the Dragon's mouth will cause it to open.

The Demon Face: Demons seal all of their bargains in blood. If a character inflicts a *Wound* on themselves and pours fresh blood into the Demon's mouth, it will open.

The Human Face: The human lust for money is well documented. Placing even a single gold coin in the Human's mouth will cause it to open.

All items placed in the mouth cavities of the face carvings are permanently lost.

Complications & Twists:

- None.

Number of Exits: 4. When the proper offering is made to one of the face carvings, its mouth hinges open wide enough to allow man-sized individuals to pass through.

Rewards: None

Chamber of Mists

Listen: You hear nothing.

When you open the door to this room silvery mists come billowing out. The mist is impenetrably thick and cool on your skin.

Visibility is very poor inside the *Chamber of Mists*: characters can only see 5' (1 square) in any direction. The *Mist Vampire* will wait until its prey is several steps into the room before swooping in to attack.

The mist itself is magical in nature and cannot be burned away. It constantly regenerates itself.

Complications & Twists:

- None

Number of Exits: 2

Rewards: A careful search of the room (*Notice -4*) reveals the drained husk of a human corpse wearing a gold necklace valued at 300 gold pieces.

Mist Vampire (WC)

Strength: NA	Smarts: d10	Agility: d8	Spirit: d10	Vigor: d6
Pace: 6	Parry: 6	Toughness: 7	Fighting: d8	
Gear & Weapons: None				
Edges & Powers: <i>Incorporeal</i> (can pass through solid objects; can only be hit by magic or magic weapons); <i>Life Drain</i> (+2 to hit; make a <i>Vigor -2</i> check or sustain 1 <i>Wound</i> ; Mist Vampire heals 1 <i>Wound</i>); <i>Undead</i> (+2 to recover from <i>Shaken</i> ; +2 <i>Toughness</i> ; immune to called shots)				

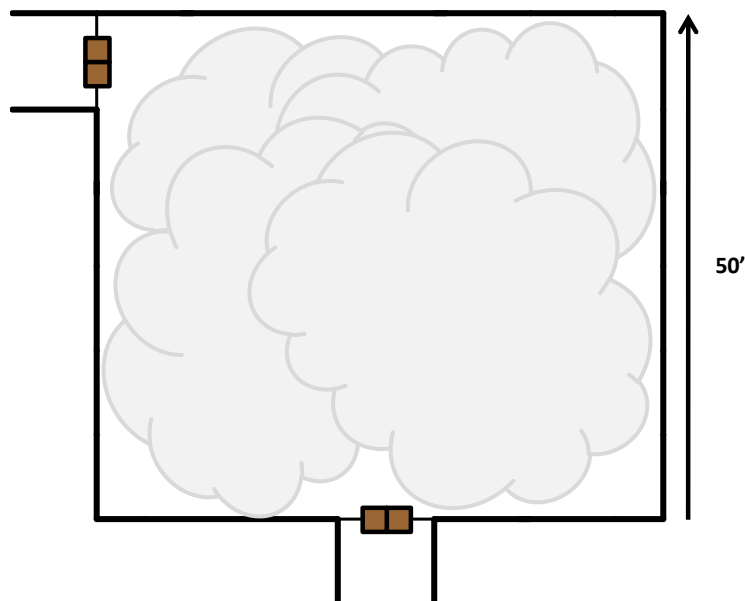

The Soul Organ

Listen: You hear nothing.

A baroque organ constructed out of ebony and bone occupies the far wall of this room. You can see reams of sheet music arranged on the music stand above the keyboard. There are no other apparent exits from the room.

If a character with the *Perform* skill sits down at the organ they can attempt to play the song written on the sheet music. It is a *toccata* with three movements. Make a *Perform* check for each movement; if all three are successes, the organ grinds to one side revealing the exit from this room. If two of the three checks result in *Raises*, a hidden compartment in the organ clicks open, revealing a special *Reward*. Lastly, for each failure a *Spectre* is summoned to attack the party. The song must be played in its entirety without mistakes to reveal the exit. There is no limit to the number of *Spectres* that can be summoned.

Complications & Twists:

- You can hear organ music being played through the door. When you open it, you see a *Lich* playing the organ masterfully. He will intentionally miss a few notes to summon *Spectres* to attack the party.
- The organ is actually a disguised *Bone Golem* who attacks the first person that sits down to play it

Number of Exits: 2. The only other exit from this room is behind the organ.

Rewards: Inside the hidden compartment is a bone *Wand of Necromancer*

Spectres				
Strength: N/A	Smarts: d6	Agility: d8	Spirit: d12	Vigor: d10
Pace: 6	Parry: 6	Toughness: 9	Fighting: d8	Stealth: d12+4
Gear & Weapons: None				
Edges & Powers: <i>Chilling Touch</i> (+2 to hit; <i>Vigor</i> -2 or lose a die of both <i>Strength</i> and <i>Vigor</i>); <i>Incorporeal</i> (can pass through solid objects; can only be hit by magic or magic weapons); <i>Undead</i> (+2 to recover from <i>Shaken</i> ; +2 <i>Toughness</i> ; immune to called shots)				

Dealing with Death

Listen (-2): You hear the sound of cards being shuffled.

This room is bare save for a table and two chairs located in the center. A skeletal figure in a black robe is seated in one of the chairs. It raises its sightless eye sockets in your direction as you enter. The skeleton is shuffling a deck of playing cards and has a small, neat stack of black chips resting near at hand. It gestures to you to take the other seat

Note: This encounter requires a working knowledge of Texas Hold'em style Poker.

When a character sits down in the available chair a stack of black poker chips will magically appear in front of them. They get four chips minus one for every *Wound* they currently have. These chips represent the character's remaining life force. The *Lich* has four chips in its stack.

The *Lich* will then explain the rules of the game, which is *No Limit Texas Hold'em* but is called *Royal Gambits* in this campaign setting. The person sitting next to the dealer is required to ante with one chip and can bet whatever additional amount they wish. For every chip that's lost, the loser suffers one *Wound*. The victor is determined when one player or the other dies.

A player can choose to step away from the table any time they want but they will still have whatever *Wounds* they received during the game

If no one is in the mood to play, the *Lich* can be attacked. If it is defeated, the door exiting this room unlocks.

Complications & Twists:

- Double the number of chips that the *Lich* has.

Number of Exits: 2. The other exit remains locked until the *Lich* is bested.

Rewards: If the *Lich* is beaten at cards, it will toss its last soul chip to the winner before expiring. This chip allows the wielder to cheat death one time, *Resurrecting* with three *Wounds*.

Lich (WC)				
Strength: d10	Smarts: d12+2	Agility: d6	Spirit: d10	Vigor: d10
Pace: 6	Parry: 6	Toughness: 15(9)	Fighting: d8	Spellcasting: d12
Gear & Weapons: None				
Edges & Powers: <i>Magical Armor +6; Death Touch (+2 to hit; each Raise inflicts 1 Wound); Undead (+2 Toughness; +2 to recover from Shaken; Immune to Called Shots; ignore Wound penalties); Zombie Master (any Zombies created by the Lich are permanent)</i>				
Spells (50 Power Points): <i>Bolt (2PP; 3d6 damage), Blast (6PP; 3d6 damage L.B.T.), Puppet (4PP), Zombie (3PP), Dispel (3PP), Fly (6PP; Pace 12), Teleport (3PP)</i>				

The Catapult

Listen: You hear nothing.

The door opens to reveal a vast chamber with an exceptionally high ceiling. A full-sized catapult sits before you; it is pointed toward a ledge high up on the far wall of the room where the room's only other exit is located. Beneath the ledge is a moat of viscous green slime. You don't see any catapult shot lying around -- I guess that means you're the ammunition!

The catapult is your standard siege model; anyone with experience in military artillery or a working knowledge of mathematics should be able to operate it without too much trouble. It takes a *Smarts* -2 trait check to fire the catapult. Any characters that have specific *Knowledge* of siegecraft or engineering gain a +2 bonus to this roll.

For every shot fired from the catapult, the operators can gradually "dial in" their aim, gaining a +1 cumulative bonus to their skill roll for each attempt.

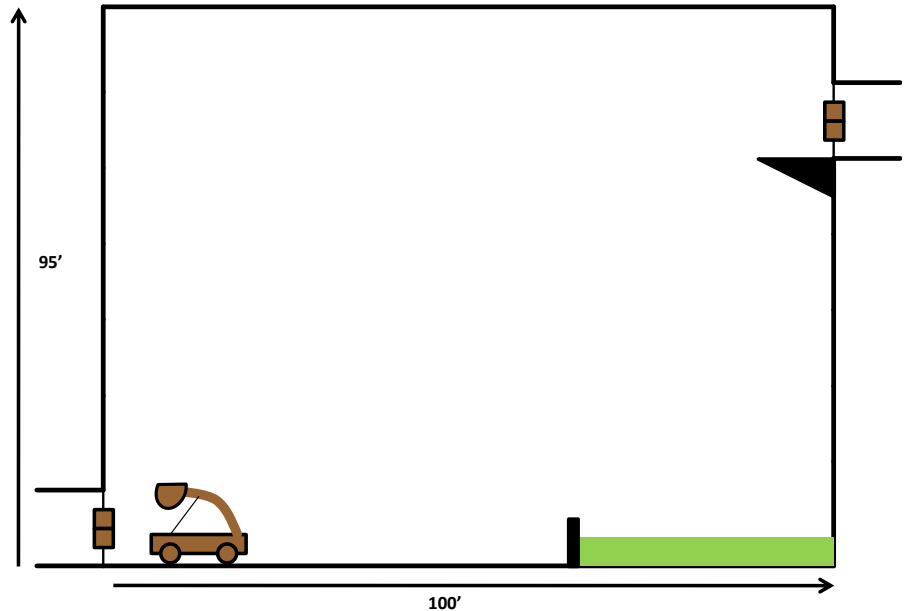

Consult the table below for the results of the catapult shot:

Smarts Check	Result
Critical Failure	Projectile misses low and strikes the wall at high velocity, sustaining 3d6 points of damage and falling into the slime moat.
Failure	Projectile fires short and lands in the slime moat
Success	Projectile hits the target zone at high velocity, sustaining 3d6 points of damage
Raise	Projectile lands perfectly in the target zone

Even though the catapult is on wheels, it will not fit in the hallways of Castle Farkinwald.

The moat of green slime is your standard issue flesh-dissolving variety. It eats through leather and clothing in 1 round, metal in 3 rounds and inflicts 2d6 points of damage on contact with bare flesh. The slime will continue to dissolve flesh until it is scoured or burned off. As it feeds the slime grows, inflicting an additional 1d6 points of damage every 3 rounds.

Complications & Twists: None

Number of Exits: 2. This is in all likelihood a one-way room. There's no way to safely return to this room without dealing with the green slime.

Rewards: None

The Scrambler

Listen: You hear a buzzing sound. *Listen (-2):* It sounds like an electrical buzzing.

This room is divided into halves by a crackling field of energy. On either side of the field are bizarre contraptions that look like oversized bird cages with glass windows. The cages look identical; both have latched doorways that appear to accommodate a single adult-sized human. The only other exit from the room is on the far side of the energy field.

Stepping into the Cage:

As soon as someone steps into one of the cages and closes the door behind them, the entire apparatus lights up and makes a loud humming noise. There's a sudden, blinding flash of light and the occupant is teleported to the other cage, but they are *Polymorphed* in the process (consult the table below). *Polymorphed* characters remain changed for 1d6 hours. If a character passes back through the Polymorph device they will regain their original form immediately.

Polymorph Results Table:

Card	Effect	Description
2	<i>Bunny</i>	Your <i>Strength</i> , <i>Agility</i> and <i>Vigor</i> dice are all reset to d4-2. Gain a +2 <i>Dodge</i> bonus and reduce your <i>Pace</i> by -2.
3	<i>Wolf</i>	Your <i>Strength</i> and <i>Vigor</i> dice are reset to d6. Your <i>Agility</i> is reset to d8. Gain a <i>Bite</i> attack (STR+d4) and increase your <i>Pace</i> by +2.
4	<i>Bird</i>	Your <i>Strength</i> , <i>Agility</i> and <i>Vigor</i> dice are all reset to d4-2. Gain a +2 <i>Dodge</i> bonus and the ability to <i>Fly</i> at <i>Pace</i> 12.
5	<i>Serpent</i>	Your <i>Strength</i> and <i>Vigor</i> dice are reset to d4. Your <i>Agility</i> is reset to d8. Gain a <i>Poison</i> attack (all targets bitten must succeed a <i>Vigor</i> -2 check or become incapacitated). Reduce your <i>Pace</i> by -2.
6	<i>Bison</i>	Increase <i>Strength</i> and <i>Vigor</i> by two die steps. Your <i>Agility</i> is reset to d6. Gain a <i>Gore</i> attack (+4 damage when charging)
7	<i>Cat</i>	Your <i>Strength</i> and <i>Vigor</i> dice are reset to d4. Your <i>Agility</i> is reset to d8. Gain <i>Night Vision</i> and a +2 bonus to all <i>Climbing</i> and <i>Leaping</i> checks.
8	<i>Ethnic Swap</i>	Statistics are unchanged. You skin, hair and eye color change, as well as your morphological features (i.e. face shape, body type, etc.)
9	<i>Elf</i>	One step die increase to <i>Agility</i> ; acquire the <i>All Thumbs</i> Hindrance. Gain <i>Night Vision</i> . +1 <i>Charisma</i> .
10	<i>Hobgoblin</i>	Statistics are unchanged. Gain <i>Night Vision</i> .
J	<i>Dwarf</i>	One step die increase to <i>Vigor</i> ; -1 <i>Pace</i> . Gain <i>Night Vision</i> .
Q	<i>Kobold</i>	Decrease <i>Strength</i> by two die steps; -2 <i>Toughness</i> . Gain <i>Night Vision</i> and a +1 <i>Dodge</i> bonus.
K	<i>Gargoyle</i>	Traits are unchanged. Gain <i>Flight</i> (can fly at your normal <i>Pace</i>) and <i>Armor</i> +2.
A	<i>Ogre</i>	Increase <i>Strength</i> by two die steps; +2 <i>Toughness</i> .
Joker	<i>Cambion Demon</i>	Gain <i>Demon</i> sub-type (+2 to recover from <i>Shaken</i> ; immune to disease and poison; 1/2 damage from normal weapons)

Passing through the Energy Field:

The energy field is designed to destroy any non-living matter it comes into contact with. Characters can pass freely through the field but all of their worn gear would be destroyed in the process.

Complications & Twists:

- Instead of destroying your gear, the Energy Field disenchant all of your magic items and drains 1d12 power points.
- Instead of destroying your gear, the Energy Field shocks you for 2d6 points of Electrical damage (+1d6 points of damage if you're wearing metal armor)
- Instead of destroying your gear, the Energy Field is impassable.

Number of Exits: 2

Rewards: None

The Sand Chamber

Listen: You hear nothing.

This room is shaped like a grain silo. It is about 60' tall and cylindrical. Far above in the ceiling you can see a trap door. In the middle of the floor is a closed chest.

As soon as the chest in the center of the room is opened, the door that the party entered by slams shut and is barred. Sand begins pouring in from vents located around the circumference of the ceiling. The sand fills the room at a rate of about 5' per round. After 2 rounds the chest will be buried. The sand continues to fall until it reaches the room's ceiling.

Characters must make a *Swimming* check each round to remain on top of the sand. This roll is modified by the character's weight -- they suffer a -1 penalty for every 25 lbs. they carry. Characters that fail a *Swimming* check become partially buried and suffer a -2 penalty to their next *Swimming* check. Characters that fail more than one check become fully buried, suffering a -4 penalty to all subsequent checks. Fully buried characters also run the risk of drowning; they can hold their breath for $1/2 \text{ Vigor} + 2$ rounds before falling unconscious.

Once the room fills halfway (6 rounds) a grinding sound can be heard and a *Sand Worm* is released into the room. This worm will target a random person every round and try to pull them down into the sand with a *Strength d10* grapple attack. The worm has a *Toughness* of 6 and will flee if it sustains any damage.

Complications & Twists:

- Add more *Sand Worms*
- Replace the sand with water

Number of Exits: 2. Once this room fills with sand it becomes impassible.

Rewards: The chest is full of 4000 gold pieces. Each round a character can make an *Agility* roll to scoop up as much gold as possible. Multiply the result of the roll by 10 to determine how many coins the character collects.

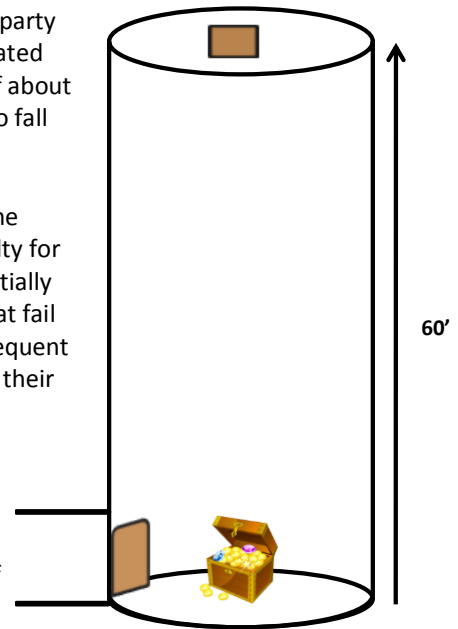

The Cursed Blades

Listen: You don't hear a thing.

In the center of this room is a block of granite. Three impressive looking swords are thrust into the block nearly to the hilts. The three other exits from this room appear to be sealed by energy fields: one is shimmering white, another looks like gray static and the third is impenetrably black. From where you are standing you can see that the blades are similarly color-coordinated.

If any characters examine the blades read them the descriptions below. The name of each blade is etched on the tang in a readable, albeit old, version of the Common tongue.

Drawing the swords is not as simple as grabbing on and pulling really hard. Each blade is attuned to a different trait and that trait must be used to pull the blade free. See the table below for each blade's draw requirement.

If one of the swords is swung against the energy field that corresponds to its color (Fellgrim for black, Glamglint for white and Mirthwane for gray) that energy field shatters and disappears, enabling the party to egress through that doorway. The energy fields are otherwise indestructible and cannot be removed by any magic the party knows.

Name	Draw Requirement	Description	Powers
<i>Fellgrim</i>	<i>Spirit -4</i>	A black-bladed long sword with an oversized grip	This blade inflicts an extra 1d8 points of damage per hit but the wielder sustains one half of all damage they inflict with it.
<i>Glamglint</i>	<i>Strength -4</i>	A chrome steel long sword with a handle wrapped in white leather.	Increases the wielder's <i>Strength</i> by 2 die steps but reduces their <i>Smarts</i> by 2 die steps. A successful <i>Smarts -2</i> roll is required to relinquish the blade.
<i>Mirthwane</i>	<i>Vigor -4</i>	A rather shabby looking dull gray long sword that has seen hard use.	The wielder of this sword gains a <i>Fatigue</i> level every time they inflict a <i>Wound</i> on a target, but that target is aged by 20 years. Only affects mortals (<i>Demons, Constructs, Undead, Elementals</i> and <i>Oozes</i> are immune).

Complications & Twists:

- If the adventurers have been in this room before, one or more of the blades are already gone.
- Sir Tristan Greyarch or Kelwin Brightblade from *The Duelists* is here. He has just drawn one of the blades.

Number of Exits: 4. Once one of the energy fields is removed it remains so permanently.

Rewards: Any and all of the swords can be kept if the party meets the draw requirements.

Burn Notice

Listen: You hear nothing.

Unlike most of the Castle, this room has a high, arching cathedral ceiling with a small chandelier burning in the center. Even by this very faint light, you can see that the ground before you glistens as if wet. The room is long and narrow; there doesn't appear to be any way across without stepping in the liquid.

The entire floor of this room is filled with 1' of lamp oil. The oil is extremely slippery; every time a character moves in the stuff they must make an *Agility* check at a cumulative -1 per square traveled beyond the first or fall prone.

Example: Lars the Lucky runs across the oil slick at his full *Pace* of 6. This means he needs to pass an *Agility* -5 check to remain standing.

Falling in the oil does two things: it startles the *Fire Bats* lurking above and it coats the character from head to toe with flammable oil. Oil-soaked characters will combust immediately when subjected to any open flame. Only prolonged immersion in water will dilute the oil's effectiveness.

If the party is stealthy and does not fall, they should be able to pass the room without disturbing the bats.

Complications & Twists:

- None

Number of Exits: 2

Rewards: None

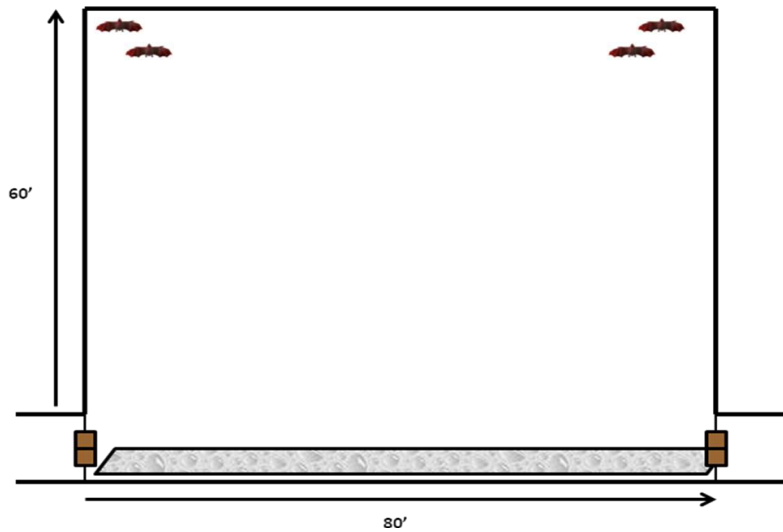

Fire Bats (4)

Strength: d4	Smarts: d4(A)	Agility: d8	Spirit: d6	Vigor: d6
Pace: 12 (Fly)	Parry: 4	Toughness: 2	Fighting: d4	
Gear & Weapons: Bite (STR)				
Edges & Powers: <i>Lesser Fire Aura</i> (all adjacent targets take 2d4 Fire damage per round and have a 1 in 6 chance of combusting); <i>Fly</i> (Pace 12); <i>Sonar</i> (bats can see in absolute darkness but suffer a -4 to hit stationary targets)				

The Troll Machine

Listen: You hear nothing.

As you open the door to this room you can see a small hole in the 20' high ceiling that irises open. Directly beneath it on the floor is some kind of a lever that audibly clicks into a locking position. Loud, bestial howling sounds can be heard from a hidden space above you and a goblet of green flesh falls from the hole, slapping wetly against the floor. In the blink of an eye the hunk of meat morphs into a 8' tall, green skinned brute with warty skin and a shock of jet black hair.

The hunks of troll meat are being dropped into an *Aging Trap* that instantly grows the troll into a fully formed adult. A new troll will be produced every 3 rounds until the lever in the center of the room can be pulled. If a character is exposed to the aging trap, they are unnaturally aged by 20 years (see "Adventure Notes" for more details on aging). A creative use of tools would allow the lever to be pulled without subjecting anyone to the effects of the trap.

Exiting and re-entering the room re-primed the trap.

If anyone manages to shrink themselves and travel into the ceiling hole (however unlikely that may seem) they will find themselves in a small cubicle filled with an ancient troll that is periodically slashed by a blade trap. Killing this troll will neutralize the threat.

Complications & Twists:

- Randomize the rate at which troll parts are dropped into the trap

Number of Exits: 4

Rewards: An early retirement, if you spend enough time in the *Aging Trap*.

Trolls				
Strength: d12+2	Smarts: d4	Agility: d6	Spirit: d6	Vigor: d10
Pace: 7	Parry: 6	Toughness: 10(9)	Fighting: d8	
Gear & Weapons: Claws (STR + d4)				
Edges & Powers: <i>Fast Regeneration</i> (make a <i>Vigor</i> check each round to heal 1 <i>Wound</i> ; Fire and Acid prevent this); <i>Rubbery Hide</i> (Armor +1); <i>Infravision</i> (can see in the dark)				

Time Bomb

Listen: You hear nothing.

A closed wooden chest sits in the middle of this room. It is suspiciously unattended.

All of the other exits from this room are locked and barred. As soon as any character steps on the pressure plate that surrounds the chest (shaded in gray below) a Magic Mouth appears and says, "THIS ROOM WILL SELF-DESTRUCT IN 5 MINUTES". The door that the party entered by also slams shut and locks.

The chest is not locked and contains a strange device (see visual aid below). The crystals in the device need to be manipulated in order to disarm the explosive. The correct code to disarm the bomb is to place the crystals in the following slots and pull the lever: R = 1; V = 2; O = 3; B = 4; G = 5; Y = 6. If the lever is pulled with any other arrangement of crystals, the bomb detonates immediately.

The party has about 50 rounds worth of time to figure out what they want to do. If the chest explodes it inflicts 6d6 damage to all of the room occupants (half damage if the party can produce some cover). Once the bomb is deactivated or goes off all the doors unlock.

Complications & Twists:

- Switch up the crystal sequence

Number of Exits: 4. The exits will only unlock once the bomb has been disarmed or detonated.

Reward: None

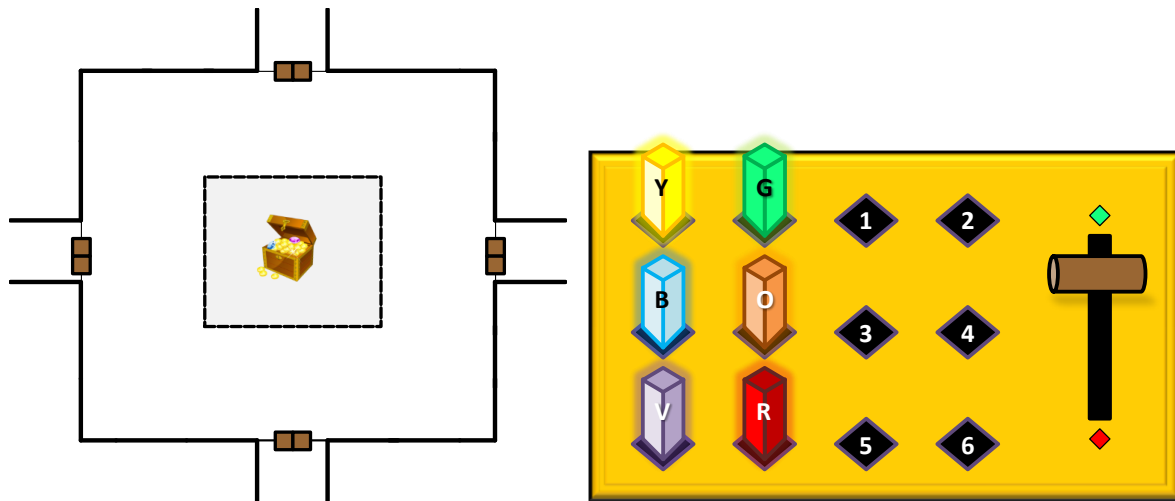

Broken Elevator

Listen: You hear nothing.

This room is barren save for a yard-long wooden lever that is mounted in the center of the floor. The frames of three doorways occupy the middle of the room's other walls, but instead of doors you just see blank stone.

As soon as the lever in the center of the room is pulled, the room shakes violently and begins to free-fall. All occupants of the room sustain 2d6 points of falling damage. Where you saw stone blocks before you can now see wooden doors in each of the door frames.

Number of Exits: 4. This is a one-way room. Once the lever is pulled the other 3 exits become available but it is impossible to go back through the way you came in.

The Shocker

Listen: You hear high frequency buzzing.

The floor of this room is inlaid with metallic gridlines. The air above it hums with energy. You can see a row of metal rings embedded in the ceiling that traverse from where you are standing to the room's other exit. It seems like you could swing from one to the other to cross this space.

It takes three consecutive *Climb* checks to safely swing through the room. If any one of the checks fails, the character falls and is shocked.

Anyone who touches the floor of this room sustains 2d6 points of Electrical damage per round (+1d6 damage if you are wearing metal armor).

It is possible to short-circuit the electrical grid if a sufficiently long (10') metal object can link the floor to one of the ceiling rings. This will negate the electrical charge and make the room safe to walk through. Alternatively, if any character is wearing insulated footwear (such as, say, the rubbery hide of a troll tied to their boots) they can safely traverse the room.

Complications & Twists:

- The floor is electrified with necrotizing energy that turns living beings into undead.

Number of Exits: 2

Rewards: None

The Hole in the Wall

Listen: You don't hear a thing.

The only unusual feature in this room is the 1' wide hole that you can see in one of the walls. It is impenetrably black and surrounded by some sort of silvery runic inlay.

Nothing happens in this room unless someone brave or stupid enough decides to put something in the mysterious hole. Most objects or man-sized appendages will fit in the hole.

An appendage or object can only be placed in the hole one time. Subsequent exposures have no additional effect.

Object Transformation Table:

Card	Result
2	<i>Disintegration:</i> The object is reduced to dust.
3	<i>Firebrand:</i> The object gains the <i>Flaming</i> descriptor. When wielded it is surrounded with a fiery aura that inflicts 1d6 points of additional fire damage.
4	<i>Ghostly:</i> The object becomes spectral and insubstantial. It no longer affects corporeal targets but can inflict damage against incorporeal ones.
5	<i>Star Forged:</i> The object turns into Cold Iron, retaining all other properties it once had.
6	<i>Venomous:</i> The object becomes slick with a poison coating that naturally replenishes itself. Any targets <i>Wounded</i> by the item must make a <i>Vigor -2</i> check or suffer an additional <i>Wound</i> .
7	<i>Brittle:</i> The object becomes unnaturally frail. Any time a 1 is rolled when the item is being used it breaks.
8	<i>Blessed:</i> The object gains the <i>Good</i> descriptor. It inflicts an extra 1d10 points of damage when used against <i>Undead</i> or <i>Demon</i> type creatures.
9	<i>Bollixed:</i> The object becomes unlucky. Any time a 1 is rolled when the item is being used something unfortunate happens (i.e. the wielder trips and falls, the object slips out of the wielder's hand, etc.)
10	<i>Frostbrand:</i> The object gains the <i>Cold</i> descriptor. When wielded it is coated with a layer of frost that inflicts 1d6 points of additional cold damage.
J	<i>Exploding:</i> The next time the object is used to strike something it explodes for 4d6 points of damage, affecting all targets in a Medium Blast Template area. The object is destroyed in the explosion.
Q	<i>Unholy:</i> The object gains the <i>Evil</i> descriptor. It inflicts an extra 1d10 points of damage when used against good-aligned creatures (such as Angels, Unicorns, Fairies, High Elves, etc.)
K	<i>Enchanted:</i> The object becomes enchanted. It receives a +1 bonus to <i>Fighting</i> , <i>Throwing</i> and <i>Shooting</i> rolls and inflicts +1 damage
A	<i>Adamantium:</i> The object turns into Adamantium, retaining all other properties it once had. It is now indestructible.
Joker	<i>Energized:</i> The item turns into an object of pure force. It is indestructible and gains +4 <i>Armor Piercing</i> .

Appendage Transformation Table:

Card	Result
2	<i>Disintegration:</i> Your appendage is painlessly disintegrated leaving nothing but a perfectly clean and cauterized stump.
3	<i>Crystallized:</i> Your appendage turns into diamond-hard living crystal. It is just as pliable and capable as an appendage made of flesh but is much tougher. The affected limb is immune to called shots and your overall <i>Toughness</i> is increased by +1. If your head is crystallized you die instantly.
4	<i>Midas Touch:</i> Your appendage turns into solid gold. If it is lopped off it is worth quite a bit (16 gold pieces per pound). Of course if your head gets the Midas treatment, you die -- but you die rich.

5	<i>Invisible:</i> Your appendage vanishes, becoming completely and permanently invisible.
6	<i>Monstrous:</i> The affected appendage becomes monstrous looking: scaly, horned and misshapen. Your <i>Charisma</i> is reduced by two.
7	<i>Armored:</i> Your appendage becomes covered with a thick, articulated exoskeleton. You gain <i>Armor +1</i> .
8	<i>Sparkly:</i> Your appendage glows and sparkles, emitting light over a Small Blast Template area.
9	<i>Enhanced:</i> Depending upon which appendage you put in the hole, your attributes are <u>enhanced</u> in some way: <ul style="list-style-type: none"> • <i>Hand</i> (one step increase to your <i>Agility</i> die) • <i>Arm</i> (one step increase to your <i>Strength</i> die) • <i>Foot/Leg</i> (<i>Pace +1</i>) • <i>Head</i> (one step increase to your <i>Smarts</i> die)
10	<i>Diminished:</i> Depending upon which appendage you put in the hole, your attributes are <u>decreased</u> in some way: <ul style="list-style-type: none"> • <i>Hand</i> (one step decrease to your <i>Agility</i> die) • <i>Arm</i> (one step decrease to your <i>Strength</i> die) • <i>Foot/Leg</i> (<i>Pace -1</i>) • <i>Head</i> (one step decrease to your <i>Smarts</i> die)
J	<i>Color Shift:</i> The skin of your appendage has changed color dramatically
Q	<i>Aquatic:</i> The skin of the affected appendage becomes damp and clammy. <ul style="list-style-type: none"> • <i>Hand/Arm/Leg/Foot</i> (the appendage becomes webbed. You gain a +1 bonus to all <i>Swimming</i> checks) • <i>Head</i> (you develop gills and can now breathe underwater. Gills must be kept moist at all times or you will gain <i>Fatigue</i> levels)
K	<i>Spectral:</i> The appendage becomes ghostly and incorporeal. It can no longer wear or hold physical equipment and cannot interact with physical objects without an act of extraordinary will on the character's part (a successful <i>Spirit</i> check allows the appendage to physically manifest for 1 round) The appendage can be used to strike other incorporeal beings normally.
A	<i>Animal Style:</i> The appendage takes on an animal-like appearance and characteristics. Your <i>Charisma</i> is reduced by 1 and: <ul style="list-style-type: none"> • <i>Hand/Arm:</i> Your arm turns into a forepaw. Gain a STR + d4 <i>Claw</i> attack. You can no longer wield weapons and common objects with this hand • <i>Foot/Leg:</i> Your leg turns into a hind paw. Gain a +1 bonus to <i>Pace</i>. You can no longer wear boots on this foot • <i>Head:</i> Your head turns cat, bear or dog-like. You gain a STR + d4 <i>Bite</i> attack
Joker	<i>Nightborn:</i> The skin of the affected appendage turns pale white. Hair and nails blacken and your eyes, if affected, turn deep purple. <ul style="list-style-type: none"> • <i>Hand/Arm/Foot/Leg</i> (no effect, beyond the cosmetic differences) • <i>Head</i> (permanently gain the power of <i>Ultravision</i>. You can see in the dark and see through both illusions and invisibility)

Complications & Twists: Nothing special. The random effects of the hole are complicated and twisty enough.

Number of Exits: 3

Rewards: None

Thin Ice

Listen (-4): You think you hear the sounds of flapping wings.

When the door opens a blast of chill air hits you full in the face. A staircase descends into a room which, you can see by the edge of your torchlight, is frosted over by ice.

As soon as someone steps on the staircase, all of the steps flatten and turn the stairs into a dangerous slide. The character stepping on the stairs must make an *Agility -2* check or fall into the room. Sliders sustain 2d6 points of falling damage from slamming into the far wall of the room and cause the ice beneath them to become *cracked* (see below for details). The *Air Mephits* then attack immediately.

The ice is extremely slippery; every time a character moves on it they must make an *Agility* check at a cumulative -1 per square traveled beyond the first or fall prone. When you fall on the ice, the square you were standing on becomes *Cracked*. A second fall in the same area will cause the ice to break.

Example: Lars the Lucky runs across the ice at his full *Pace* of 6. This means he needs to pass an *Agility -5* check to remain standing.

Once the ice breaks, the character is plunged into near freezing water. They must succeed a *Swimming* check to crawl out of the water. For every round they are submerged they suffer a cumulative -1 penalty to their *Swimming* check due to the cold. The *Water Elementals*, of course, will try to pull the swimmers down.

Complications & Twists:

- None.

Number of Exits: 3

Rewards: At the bottom of the freezing water is a fist-sized blue topaz worth 1500 gold pieces.

Air Mephits (4)

Strength: d4	Smarts: d6	Agility: d10	Spirit: d6	Vigor: d6
Pace: 6 (Fly)	Parry: 6	Toughness: 4	Fighting: d8	
Gear & Weapons: Claws (STR + d4)				
Edges & Powers: <i>Air Blast</i> (cone template; all targets in area must make a <i>Strength -2</i> check or be <i>Shaken</i>); <i>Fly</i> (can fly at <i>Pace</i> 6); <i>Immune</i> to Cold; <i>Invisibility</i> (can turn invisible as a standard action)				

Water Elementals (2)

Strength: d10	Smarts: d6	Agility: d8	Spirit: d6	Vigor: d10
Pace: 6	Parry: 6	Toughness: 7	Fighting: d8	
Gear & Weapons: Bash (STR)				
Edges & Powers: <i>Elemental</i> (immune to called shots, disease and poison); <i>Invulnerability</i> (immune to non-magical attacks); <i>Weakness: Fire</i> (sustain 1d6 points of damage from non-magical fire); <i>Ooze</i> (can seep through tiny gaps); <i>Water Blast</i> (cone template; all targets in area must make a <i>Strength -2</i> check or be <i>Shaken</i>)				

The Balance Test

Listen: You hear nothing but can smell the foul aroma of strong acid.

The floor of this room drops away some 10' below the doorway and is filled with bubbling acid. The stench alone is nearly enough to knock you out. A number of 10' tall stone pillars rise out of the acid and dot the way between you and the room's only exit. Linking these are a series of precarious looking wooden planks, ramps and beams that create a path of sorts from one exit to the other, using the pillars as anchor points. Just in case you thought this didn't sound so bad, several large flails also swing from the ceiling of this room, cutting a deadly arc across your intended course.

Four *Agility* checks are required to safely cross this room. If any *Agility* check fails, the character is afforded a chance to make a desperation grab before plunging into the acid. This second attempt is resolved as an *Agility* -2 check. If the character succeeds they manage to grab on to a plank or pillar before touching the acid. They can make a simple *Climb* check to get back on the course.

The acid causes 2d10 points of acid damage per round and corrodes metal items.

Complications & Twists:

- The ramps are gone and the characters must leap from flail to flail to cross the room.
- The pillars begin to sink when any weight is placed on them. They drop at a rate of 2' per round.

Number of Exits: 2

Rewards: None

The Great Underground River

Listen: You hear the sound of rushing water.

The door opens to reveal a small sandy beach in a naturally formed cavern. An underground river thunders past, diving and dipping around treacherous rocks as it flows from west to east. The light in here is poor; there are a couple of torches lighting the beach you are standing on. Off in the distance, almost obscured from sight, you can see the faint glimmer of more torches marking a second beach. A simple rowboat is moored a few steps away from you. It looks like you'll have to brave the rapids if you want to reach that other beach.

The character with the best *Boating* skill must make a check every round to steer the craft in a desired direction. The pilot suffers a -2 to this roll if they are cutting across the current and a -4 if they are steering against the current. The boat is carried by the rapids at a *Pace* of 12. If any *Boating* check fails, the boat is carried in the direction of the current (see the arrows on the diagram below).

The Treasure Chest:

As the rowboat draws near the island containing the treasure chest the party can make a *Notice* -2 check to see if they spot the treasure.

Falling in the water:

Any character who falls in the water will be swiftly carried toward an underwater tunnel at a *Pace* of 12. Strong swimmers have a remote chance to making it to the other beach before being sucked underwater. If they pass a *Swimming* -4 check they make a water-logged landing on the far shore.

Characters who miss this chance are very likely to drown or be buffeted to the point of unconsciousness. Once pulled into the underwater tunnel, a character must make a *Swimming* -2 check every round or suffer 2d6 points of bludgeoning damage. Characters who succeed with a *Raise* manage to find an air pocket so that they can replenish their breath. A character can hold their breath for $1/2 \text{ Vigor} + 2$ rounds. After 6d6 rounds of submersion, the character comes tumbling out of Castle Farkinwald into a nearby lake. An opportunistic band of scavengers lives in the area siphoning loot off of the occasional dead adventurer that comes floating out of the Castle. If a character miraculously manages to survive their underwater ordeal the scavengers will rescue them, but only if they believe there's a prospect of a reward.

Areas marked with red circles indicate the location of *Cave Fishers*. These insects will use their adhesive lures to snare unwary adventurers.

Complications & Twists:

- After 6d6 rounds of submersion, the river deposits drowning adventurers on the shores of an underground lake near the subterranean Gnomish City of Garlburg. The locals find and revive you, but that's an adventure for another day...

Number of Exits: 2. This is a one-way room; it is impossible to navigate upstream once you have sailed to the other exit.

Rewards: The chest on the island contains 2000 gold pieces, 3 bottles of good wine and a bolt of silk valued at 500 gold pieces.

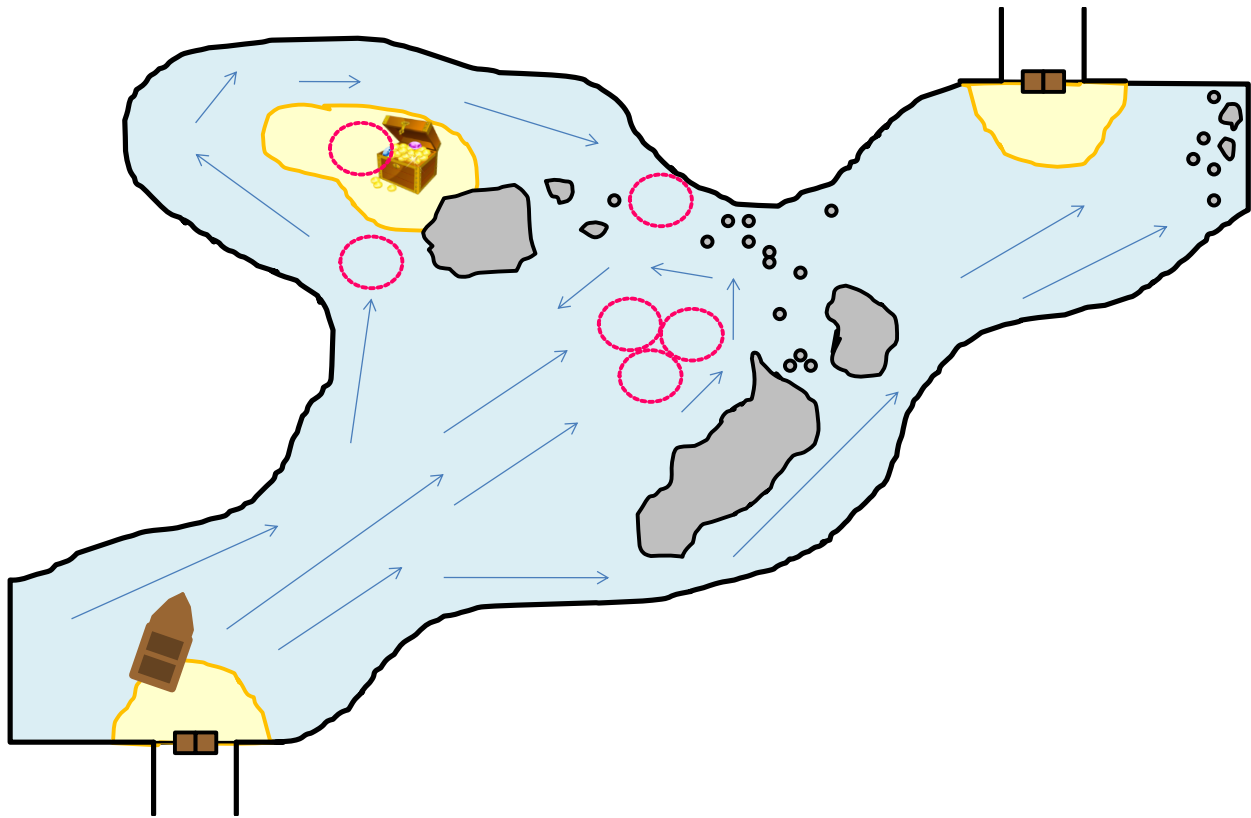

Cave Fishers (6)

Strength: d8	Smarts: d4(A)	Agility: d6	Spirit: d6	Vigor: d8
Pace: 6	Parry: 5	Toughness: 8(6)	Fighting: d6	
Gear & Weapons: Bite (STR + d8)				
Edges & Powers: <i>Wall Walker</i> (can scale any surface at their normal Pace); <i>Adhesive Lure</i> (+2 to hit; make an <i>Agility</i> -2 check or become stuck to the Cave Fisher's lure; Fisher reels targets in by 10' per round; lure has a <i>Toughness</i> of 8 and is vulnerable to fire and alcohol)				

Hand Locks

Listen: You hear nothing.

All of the doors exiting this otherwise ordinary room have hand-sized slots in the place where door handles would normally be and are made of iron instead of wood.

These doors cannot be battered down by main strength alone.

If any character places their hand in one of the slots a steel clamp fastens to their wrist and binds them firmly. They can feel levers, springs, latches and pins with their fingertips. The character needs to make a series of skill and trait checks in order to unlock the door. All checks must be made successfully. If any single check fails the character suffers the indicated consequence (see below).

Lock	Lock Sequence	Failure
A	1st Lock: <i>Lockpicking</i> 2nd Lock: <i>Agility</i>	<i>Hand Chopper:</i> Your hand is taken off at the wrist by slicing razors. Immediate medical attention is required to prevent bleeding out. The door unlocks.
B	1st Lock: <i>Lockpicking</i> 2nd Lock: <i>Agility -2</i> 3rd Lock: <i>Lockpicking -2</i>	<i>Poison Needle:</i> You feel a sharp prick and your hand is released. Make a <i>Vigor -4</i> check or die from poison.
C	1st Lock: <i>Lockpicking -2</i> 2nd Lock: <i>Agility -2</i> 3rd Lock: <i>Lockpicking -2</i> 4th Lock: <i>Strength</i>	<i>Gas Trap:</i> All doors slam shut and chlorine gas is released into the room. All occupants must make a <i>Vigor -2</i> check or suffer 2d10 points of damage.

Complications & Twists:

- Change the order of the locks

Number of Exits: 4. The exits labeled A, B and C must be unlocked before they can be used.

Rewards: None

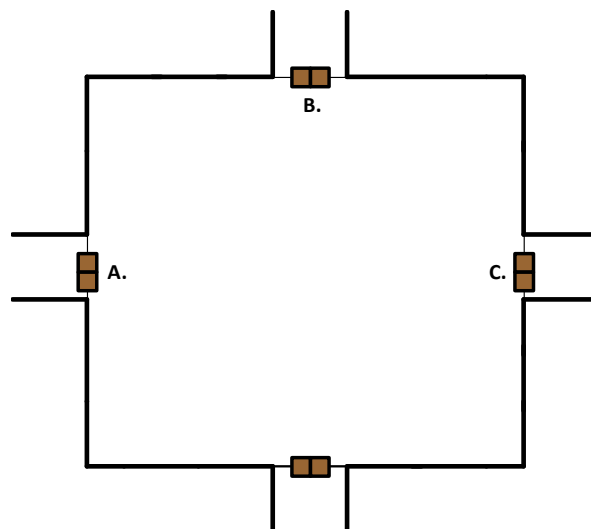

Second Exit

Listen (-2): You hear what sounds like a faint breeze.

This room is fairly unremarkable except for the fact that it has a very high ceiling. You can feel fresh air blowing in from a crawlspace located about 40' above you.

Reaching the Exit:

Anyone with a reasonably decent *Climb* skill should be able to free climb up to the crawlspace, whereupon they can secure a rope to allow their companions to ascend safely (you did bring a rope, right?) Four consecutive *Climb* successes are required to reach the crawlspace; a *Raise* counts as 2 successes.

Alternatively, there are some resources hidden in this room that can be used to help less physically inclined characters reach the exit. A basic search of the room (*Notice* check) reveals that a 10'x10' section of the wall has had most of its mortar chipped loose. It takes very little effort to dig the bricks free. Behind the loose bricks is a small cavity containing a 50' coil of hemp rope, an iron spike and a mallet.

The crawlspace leads to a mountainous slope outside of Farkinwald's Castle. If they wish, the party can return to civilization at this point and conclude the adventure (see "Conclusions" below).

If the party managed to explore at least 20 rooms, Farkinwald will pay them a special visit before they leave. His projected image will appear and he will offer his congratulations (refer to the "If Farkinwald is pleased" section of the encounter *Farkinwald Lives!*)

Remember: once the entire party leaves the dungeon, it will completely reset.

Complications & Twists:

- None.

Number of Exits: 3. Two doorways on opposite sides of the room and a crawlspace located 40' up on one of the walls.

Rewards: If Farkinwald appears, he may dispense a reward.

Empty Room

Listen: You hear nothing.

This room has every appearance of being empty. Four evenly spaced doors lead out in all cardinal directions.

This room is totally empty. Seriously, there's nothing going on here. Play up the drama by consulting the room description a few times and randomly rolling some dice. Mutter "Hmm, OK" and "Oh shit!" for good effect.

Complications & Twists:

- None

Number of Exits: 4

Rewards: None

Farkinwald Lives!

Listen (-2): You hear the sounds of very faint muttering and can smell a hint of pipe tobacco.

The door opens revealing a room furnished like a comfortable study. Bookshelves line the walls and ornate rugs cover the floor. A surly looking old man in midnight blue robes and a pointed hat sits in an overstuffed leather chair with a large book in his lap. On a mahogany table next to him a long stemmed pipe smolders in an ash tray. He looks at you over the rim of his spectacles and intones in a deep, sonorous voice, "I hope you have a very good explanation for this disruption."

The old man sitting in the chair is none other than Farkinwald himself! He's in a rather grumpy mood -- he was just getting to the good part of one of his favorite books when the party interrupted him. They'd better talk fast if they want to avoid displeasing him! If a character succeeds in making a -2 *Persuasion* roll they have managed to please Farkinwald with their good manners (see "If Farkinwald is pleased" below). If anyone fails their *Persuasion* attempt Farkinwald will be displeased by their interruption.

If the party leaves immediately via the way they entered without attempting to engage Farkinwald, he will allow them to depart unmolested. Any future visits will be met with a hostile reaction.

Farkinwald is a randy old goat. If any of the party members are female and have the *Attractive* edge they will gain a +4 bonus to their *Persuasion* roll.

If Farkinwald is pleased:

Farkinwald congratulates you on making it as far as you have. He says he's been watching your progress with great interest and would like to reward you. He will cash the party out based on the number of rooms they have explored (see "Conclusions" below) and then teleport them unceremoniously outside of his dungeon whether they want to leave or not.

If a character managed to roll a *Raise* on their *Persuasion* check, Farkinwald is especially well-pleased and will grant a +5 Room bonus to the party's treasure result (see *Conclusions* at the end of the module). If the character who pleased Farkinwald is an *Attractive* female, he will make a special proposal: he will give the party a +10 Room treasure bonus if the female character remains as his newest paramour. He promises a life of luxury and ease to the lucky lady if she should accept his terms. Characters who accept this proposal are essentially retired; they become a permanent fixture in Farkinwald's Harem. It is possible for a future expedition to rescue this character from *The Harem* if they choose to brave *Castle Farkinwald* another time.

If Farkinwald is displeased:

Farkinwald is a busy man -- he doesn't like to be disturbed by the bumpkins who wander into his dungeon. With a snap of his fingers he summons his *Staff of Zot* into his hands and uses it to *Zot* each party member, starting with the most threatening looking fighter-type.

Farkinwald *can* be attacked but he's a Legendary Wizard of tremendous power. He will most assuredly school a party of low-level characters. If, for some reason, he should manage to be defeated his corpse erupts in a towering column of blue fire that inflicts 3d10 points of damage to all adjacent targets and utterly destroys his personal possessions. Farkinwald maintains a healthy backlog of simulacra stored within a secret location and has woven enchantments to insure that his soul will be decanted into one of them in the event of his death. He will remember any defeats he suffers and carry a serious grudge if he should ever meet the adventurers again.

Complications & Twists:

- Farkinwald is not present but his still smoking pipe sits next to his still warm chair. Smoking his pipe is certain to have some unforeseen side effect....

Die Roll (d6)	Effect
1	You spend the next 1d6 hours <i>Magic Jarred</i> inside of an Iron Golem
2	You are <i>Plane Shifted</i> to an exclusive resort hidden in the Astral Plane
3	You are paralyzed for 1d6 hours
4	You contemplate life as a chicken. No effect.
5	You suddenly know how to speak 1d4 new languages.
6	Your mind expands. Gain a permanent one step increase to your <i>Smarts</i> die.

Number of Exits: 2

Reward: Farkinwald will cash you out if you please him.

The Dragon's Den

Listen (-2): You hear the sound of deep, measured breathing. Judging from the pitch and duration of the breaths, whatever is producing them is very large.

The door opens to reveal a long, naturally formed tunnel descending into a large cavern. About 100' long. Once the party gets to the end of the tunnel, read the following:

You witness a sight that you once believed only happened in story books. Perched upon a small rocky island in the middle of a black lake is a magnificent looking red dragon. It rests upon a pile of gleaming treasure. The dragon appears to have expected your visit; it eyes you in that inscrutable way that cats and lizards do and says in a rumbling voice, "Welcome, manlings. I see you have bested the wizard's playthings. I should kill you now, but I am not unreasonable. Tell Slaggnar why he should spare you."

Farkinwald has made an agreement with this dragon to guard his personal stash. The arrangement has proved to be mutually beneficial so far but the dragon is by no means another one of Farkinwald's thralls. It has a mind and motives of its own.

The Dragon's Offer:

Slaggnar will let the party pass through his cave if each character leaves a 2500 gold piece donation behind. Characters who exit the dungeon in this fashion will receive no monetary reward, but will gain experience for the number of rooms they explored.

Tactics:

If Slaggnar is engaged in combat he will fly out of melee range and breathe first. Then he will try to dive bomb wizards and tail slap any massed opponents. Against a tough fighter he will go claw/bite and try to get a quick kill.

Slaggnar, Red Dragon (WC)

Strength: d12+9	Smarts: d8	Agility: d8	Spirit: d10	Vigor: d12
Pace: 8(24)	Parry: 6	Toughness: 20(16)	Fighting: d10	Guts: -2
Gear & Weapons: Bite/Claw (STR + d8); Tail (STR -2)				
Edges & Powers: <i>Fire Breath</i> (breathes flame in a cone template; all targets must succeed an <i>Agility -2</i> check or suffer 2d10 points of Fire damage. There's a 2 in 6 chance that affected targets begin burning. Dragons cannot breathe and attack in the same round); <i>Fly</i> (can fly at <i>Pace 24</i>); <i>Scales (Armor +4)</i> ; <i>Fear Aura</i> (characters must succeed a <i>Guts -2</i> check or become <i>Shaken</i> when they first encounter a dragon); <i>+4 Reach</i> ; <i>Improved Frenzy</i> (2 melee attacks per round at no penalty); <i>Hardy</i> (does not gain <i>Wounds</i> when <i>Shaken</i> more than once); <i>Level Headed</i> (draws twice for initiative); <i>Tail Slap</i> (can make a <i>Sweep</i> attack against all targets on their flank); <i>See Invisible</i>				

Number of Exits: 2

Rewards: The dragon has a large and glittery hoard. See "Conclusions" for more details.

Tops down and Cross-section views

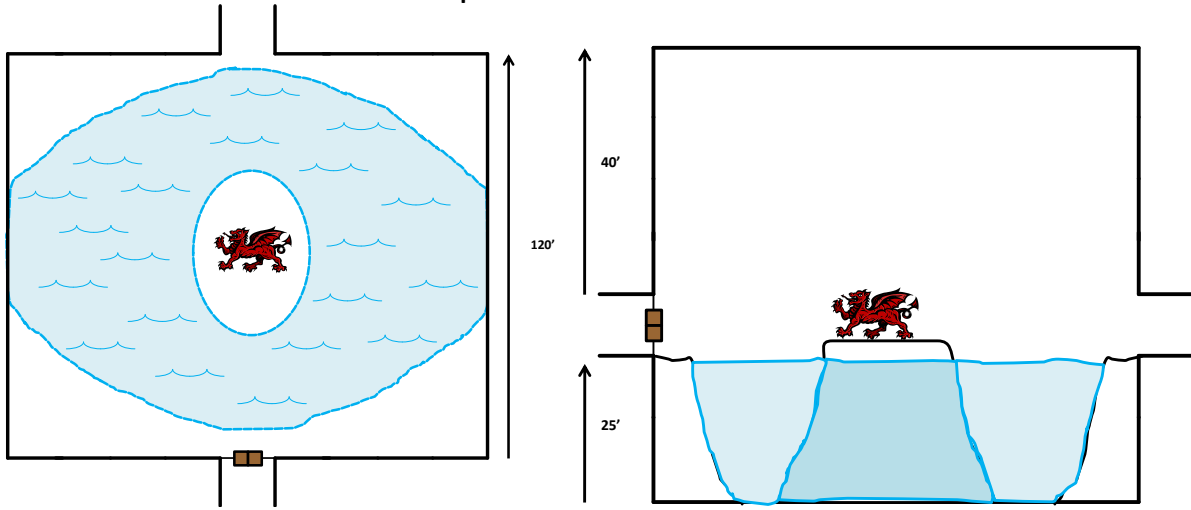

Conclusions

Merely surviving Castle Farkinwald in an accomplishment in itself; pat yourself on the back!

The amount of treasure and experience the party earns is dependent upon how many rooms they manage to conquer. Treasure is ordinarily paid out in the "Dragon's Den" to those adventurers who manage to make it all the way through the castle (but there are a couple of exceptions to this mentioned in the text).

If any *Magic Items* are awarded as part of the party's treasure, use whatever treasure generation table you'd like to determine what item is given. The *Savage Worlds Fantasy Companion* and *Advanced Dungeons & Savages* both have excellent treasure tables for this purpose.

# of Rooms	XP	Treasure
0-4	0	0 gold
5-9	1	500 gold/character
10-14	2	1000 gold/character + 1 piece of jewelry worth 1d4 x 100 gold pieces
15-19	3	1500 gold/character + 1 piece of jewelry worth 1d6 x 100 gold pieces
20-24	4	2000 gold/character + 1 piece of jewelry worth 1d8 x 100 g.p. + 1 <i>Magic Item</i>
25-29	5	2500 gold/character + 1 piece of jewelry worth 1d10 x 100 g.p. + 1 <i>Magic Item</i>
30-34	6	3000 gold/character + 1 piece of jewelry worth 1d12 x 100 g.p. + 2 <i>Magic Items</i>
35-39	7	3500 gold/character + 1d4 pieces of jewelry worth 1d12 x 100 g.p. + 2 <i>Magic Items</i>
40-44	8	4000 gold/character + 1d6 pieces of jewelry worth 1d12 x 100 g.p. + 3 <i>Magic Items</i>
Etc.	Etc.	Etc.

In addition, anyone who defeats the "Dragon's Den" receives an automatic *Advance* and one draw per character on the "Special Loot" table.

Card	Special Loot
2	<i>Small Chest</i> : An ornate jewelry box containing 1d4 pieces of jewelry valued at 1d4 x 1000 gold pieces each
3	<i>Art Object</i> : A fine painting or sculpture valued at 1d12 x 1000 gold pieces
4	<i>Large Chest</i> : A sturdy footlocker containing 1d12 x 2000 gold pieces
5	<i>Mastercrafted Armor</i> : You find a suit of random magical armor that has been forged by a true master. It is inlaid with precious metals and studded with gemstones. It's normal value is multiplied by 20.
6	<i>Magical Weapon</i> : In addition to any <i>Magic Items</i> that the party has found, you have found a random magical weapon appropriate to your training and fighting style.
7	<i>Miscellaneous Magic Item</i> : In addition to any <i>Magic Items</i> that the party has found, you have found another miscellaneous item all for yourself.
8	<i>Mastercrafted Weapon</i> : You find a random magical weapon that has been forged by a true master. It is inlaid with precious metals and studded with gemstones. It's normal value is multiplied by 20.
9	<i>Magical Construct</i> : An ornate man-sized golem that has imprinted itself on to you. This construct has the same statistics as a Living Statue but has a d8 <i>Smarts</i> and is capable of speech.
10	<i>Bound Servitor</i> : You find a magical device capable of summoning a powerful being to assist you. It is either a <i>Djinni Lamp</i> (33%), <i>Onyx Figurine</i> (33%) or <i>Bottled Elemental</i> (34%). See below for details.
J	<i>Magical Jewelry</i> : You have found a fine random piece of magical jewelry all for yourself. The item can be a ring, bracelet, necklace or gem.
Q	<i>Spells</i> : You find a cache of 1d6+1 random spell scrolls.
K	<i>Hostage</i> : You have managed to rescue a hostage from the dragon's clutches. This person is either connected to royalty or to very wealthy private interests. If they are safely returned home they will lavish lands and titles on their rescuer. Rescuer gains the <i>Noble Edge</i> (a Knighthood and a 5,000 gold piece annual stipend).
A	<i>Intelligent Weapon</i> : You have found a weapon from Farkinwald's personal stash -- a weapon imbued with

	sentience and magical powers. See Appendix A for more details.
Joker	<i>Artifact:</i> What a discovery! You've recovered a unique magical relic of tremendous power. See Appendix B for more details.

Djinni Lamp: This brass lamp contains an enslaved Djinni. When rubbed, the Djinni will emerge from the lamp to render whatever assistance it can to its owner. The Djinni will serve for a maximum of a year and a day. If it is mistreated, the Djinni may attempt to exact vengeance once its term of service has ended.

Onyx Figurine: Carved in the shape of some kind of animal (usually a Great Cat), the Onyx Figurine can transform into a full sized extra-planar animal when a command word is uttered. The animal is intelligent for a creature of its kind but cannot communicate with its owner. When the command word is spoken a second time, the animal turns back into a figurine. It can be used an unlimited number of times until it is slain.

Bottled Elemental: This metallic bottle is firmly sealed with a cork stopper. When opened the bottle releases an Elemental that will do the owner's bidding for up to 1 day, after which it returns to its home plane. The Elemental has an equal chance of being a Fire, Earth, Air or Water Elemental.

Some encounters within the castle will hand out special situational rewards. These are incremental to any rewards won at the conclusion of the adventure.

Characters can choose to leave Castle Farkinwald any time they wish by simply retracing their steps and exiting via the *Entrance Chamber*. There are also a number of events within the castle that can cause adventurers to leave involuntarily. If the party exits and re-enters the castle, they will find that the entire layout has changed. As long as one character remains alive within the castle the current layout will persist. Characters that leave the dungeon early receive any Experience Points they would have normally received but none of the treasure (unless otherwise stated in the Encounter text).

Appendix A: Intelligent Weapons

Intelligent weapons are exceptional magic items that contain the trapped soul or essence of a powerful being. In addition to its normal magical properties, an intelligent weapon has its own *Spirit* rating and is capable of casting spells.

If the wielder of a magic weapon wants to activate a triggered power from their weapon, they must convince it first by winning an opposed *Spirit* roll. Passive powers do not need to be activated in this way; they are "always on". If the weapon wins the *Spirit* contest, it cannot be bothered again for 1d4 hours. If the weapon wins the contest by with a *Raise*, it temporarily overwhelms the personality of its wielder for the next 1d4 hours.

Card	Item Name	Type	Spirit	Personality/Goals	Powers
2	<i>Smygwaldir</i>	Great Axe	d4	Brash & Cocky; speaks fluent Frost Giant	Passive: +1d6 Cold Damage Triggered: <i>Ice Blast</i> (3/day)
3	<i>Drachenspar</i>	Spear	d4	Brave & Heroic; hates Dragons	Passive: +1d10 damage vs. Dragons Triggered: <i>Detect Dragons</i> (3/day)
4	<i>Krixar'Kun</i>	Double-Axe	d4	Violent & War-like; speaks Orcish	Passive: <i>Frenzy</i> Triggered: <i>Strength Boost</i> (3/day)
5	<i>Shamal</i>	Short Sword	d6	Smooth & Cultured; a trapped Djinn	Passive: +2 <i>Pace</i> Triggered: <i>Dancing Weapon</i> (3/day)
6	<i>Malwyr</i>	Maul	d6	Emotionless; contains essence of an Earth Elemental	Passive: <i>Sunder</i> Triggered: <i>Seismic Blast</i> (3/day)
7	<i>Gray Lady</i>	Rapier	d8	Haughty & Noble; the soul of a Countess	Passive: +1 to <i>Agility</i> rolls Triggered: <i>Flurry of Blows</i> (3/day)
8	<i>Quarrel</i>	Long Sword	d8	Short-tempered & impetuous; prickly	Passive: +2 to Damage Triggered: Increase <i>Fighting</i> by 2 die steps

				sense of honor	for 3 rounds (3/day)
9	<i>Echo</i>	Halberd	d10	Contains the souls of 100 fallen soldiers	Passive: Ignore 1 point of <i>Wound</i> penalties Triggered: <i>Spectral Armor</i> (3/day)
10	<i>Crooked Shanks</i>	Dagger	d10	Sly & Greedy; encourages theft	Passive: <i>Luck</i> (1 extra <i>Benny</i>) Triggered: <i>Invisibility</i> (3/day)
J	<i>Blackwind</i>	Great Flail	d12	Contains the soul of a notorious robber knight; a blackguard of the highest order	Passive: <i>Improved Sweep</i> Triggered: <i>Knockback</i> (3/day)
Q	<i>Patience</i>	Staff	d12	Humble & Charitable; thinks of others first	Passive: +2 <i>Parry</i> (total bonus +4) Triggered: <i>Slow</i> (3/day)
K	<i>Weep</i>	War Scythe	d12+2	Vicious & Evil; encourages betrayal	Passive: +4 to <i>Injury</i> rolls Triggered: <i>Slay Living</i> (1/day)
A	<i>Aurandal</i>	Great Sword	d12+2	Religious; will risk all to save lives	Passive: +1d10 damage vs. Demons Triggered: <i>Invulnerability</i> (1/day)
Joker	<i>Hondmar's Edge</i>	Katana	d12+2	Beatific & Centered; always fights fair	Passive: +2 to <i>Fighting</i> rolls Triggered: <i>Flawless Form</i> (3/day)

Dancing Weapon: This weapon can act on its own for 3 rounds. It uses its *Spirit* die to attack and can attack any target within 12 squares of the wielder.

Detect Dragons: This weapon points in the direction of the nearest dragon. The wielder has a vague sense of how far away it is.

Flawless Form: You may re-roll any *Fighting* roll without spending a *Benny* but must keep the new result

Flurry of Blows: Wielder gains 1 extra attack for 3 rounds.

Ice Blast: Fires a blast of ice up to 12 squares away. The blast affects a Medium Blast Template area and inflicts 2d6 points of cold damage.

Improved Sweep: Wielder gains the *Improved Sweep* Edge while they use this weapon

Invisibility: Wielder can turn invisible for 10 minutes. This effect is spoiled if the wielder performs any vigorous actions.

Invulnerability: Wielder is immune to all damage for the next 3 rounds.

Knockback: Knocks the target(s) back by 1d4 squares.

Seismic Blast: Shakes the ground at the wielder's feet over a Large Blast Template area. All targets must succeed an *Agility* -2 check or fall prone.

Slay Living: A target struck by this weapon must make a *Vigor* -4 check or die of a heart attack

Slow: A target struck by this weapon has their *Pace* reduced by 2 and automatically acts last in the combat round for 3 rounds

Spectral Armor: When triggered this increases the wielder's *Toughness* by 2 for 3 rounds.

Strength Boost: When triggered this boosts the wielder's *Strength* by two die types for 3 rounds.

Sunder: If this weapon is used to make a Called Shot on another weapon or a piece of armor, it degrades the target item by 1 damage or armor point.

Appendix B: Artifacts

Artifacts are rare magic items of tremendous power. They are priceless; they're the sort of thing a Kingdom would go to war for. These items are all one-of-a-kind so if you draw an item more than once, draw again.

Card	Artifact Name	Description	Powers
2	<i>Skelper's Bane</i>	A meager and battered looking gold piece with a pair of dice stamped on both faces.	Any time someone uses a <i>Benny</i> in your presence you can choose to negate it; you gain 1 <i>Benny</i> per hour up to the allowed maximum (typically 3).
3	<i>The Skeleton Key</i>	An elaborate door key made out of fingerbones.	Can open any physical or magical lock simply by touching it. Disarms any traps that are part of the lock mechanism. Does not disarm any other kinds of traps.
4	<i>Everfull Purse</i>	Belt pouch made out of supple leather with a thread-of-gold drawstring.	If a single gold piece is left in this purse overnight, it will turn into 25 gold pieces at dawn. This power does not function if more

			than 1 gold piece is placed within it.
5	<i>Ghalorn's Armor</i>	Oversized suit of black iron plate mail inscribed with sacred glyphs.	Suit of armor that gives the wearer <i>Construct</i> properties. Imparts the following bonuses: <i>Armor +6, Toughness +4</i> , one step increase to <i>Strength</i> die, Immunity to called shots, disease and poison, 1/2 damage from Piercing weapons, one step <i>Size</i> increase, <i>Reach +1</i> .
6	<i>Tome of Exalted Wisdom</i>	Large leather-bound tome etched with silver and gold and sealed with a platinum clasp.	When read cover to cover (over 1d4 days) this book grants an <i>Advance</i> to the reader as well as a permanent one step increase to their <i>Spirit</i> die. Disappears after use.
7	<i>Talisman of Arcanus</i>	An elaborate necklace made from spun mithril that holds a pendant in the shape of Arcanus' holy symbol	Doubles the wearer's power point total and power point recovery rate. Any non-caster who puts on the Talisman takes 3d6 points of damage.
8	<i>Nalb's Stone</i>	A rather ordinary looking black rock struck through with veins of silver.	Neutralizes any poison or acid it touches. If broken open, Nalb's Stone contains <i>Alchemical Quicksilver</i> which is a crucial ingredient for the most powerful potions.
9	<i>The Fists of Cromlech</i>	A pair of black iron gauntlets fashioned to look like gothic claws.	The wearer of these gauntlets heals 1 <i>Wound</i> every time they kill someone in melee combat. If the wearer receives this benefit even one time they can never be <i>Resurrected</i> ever again.
10	<i>Quilessa's Chalice</i>	This fabled cup is wrought from the purest gold and encrusted with small precious stones.	Turns common liquids into <i>Potions of Healing</i> . The transformation process takes 1d4+1 minutes. The healing draught only retains its potency while it is in the chalice.
J	<i>The Annulus</i>	A simple ring of unidentifiable green stone.	The wearer of this ring is completely immune to magic (beneficial or otherwise). They cannot use any other <i>Magic Items</i> or cast spells while they wear this ring.
Q	<i>The Jongleur's Ring</i>	A platinum band set with a ten-faceted gem that changes color daily.	The wearer of this ring is affected by a different bonus on the dawn of each day (see below).
K	<i>Coat of Ardagon</i>	A fashionable, double-breasted, three-quarter length coat with a high, stiff collar. Woven from some kind of iridescent fabric.	This magical jacket grants the following bonuses when worn: <i>Toughness +10</i> vs. Elemental damage (fire, cold, acid, etc.), +2 to recover from <i>Shaken</i> , 1/2 damage from piercing and slashing weapons.
A	<i>The Dragon's Eye</i>	A skull-sized crystal ball that looks like a flickering golden cat's eye gem.	Grants control over Dragons. The wielder can cast <i>Puppet</i> on any dragon up to 24 squares away as a standard action. They receive a +8 bonus to the ensuing opposed roll.
Joker	<i>The God Seed</i>	A teardrop black sapphire. Must be swallowed to activate.	You have become immortal. You cannot be killed but can still be <i>Shaken, Wounded, Injured</i> or <i>Incapacitated</i> . You naturally recover from <i>Incapacitation</i> and <i>Wounds</i> in 1d12 minutes and heal injuries in 1d4 days. Even if you are obliterated, you will rise

			whole in 1d4 days near the spot of your unmaking.
--	--	--	---

The Jongleur's Ring

Die Roll (d10)	Effect
1	Immune to Disease
2	Requires no air to survive
3	Gain a +4 bonus to <i>Toughness</i>
4	Gain <i>Night Vision</i>
5	<i>Regeneration</i> : can make a <i>Vigor</i> check once per hour to heal 1 <i>Wound</i> .
6	Can <i>Fly</i> at a Pace of 12
7	Immunity to all <i>Cold</i> damage
8	Doubled <i>Pace</i>
9	Gain a +4 bonus to all opposed rolls (i.e. rolls to resist effects)
10	Wearer's Choice

The Staff of Zot

This artifact is a special mage's staff built by Farkinwald the Fantastic. It is carved from black oak and topped with a fist-sized flawless amethyst. The staff has 50 power points and is able to invoke the following powers with a successful *Spellcasting* roll:

- *Bolt of Purple Lightning*: (6 Power Points) Target must make a *Vigor* -2 check or be disintegrated. Targets who survive still sustain 2d10 points of damage.
- *Teleportation*: (5 Power Points) Target is teleported to any location the wielder wishes within 1d12 miles.
- *Amethyst Prison*: (5 Power Points) Target must make a *Spirit* -2 check or become encased in amethyst crystal. This effect is similar to *Petrification* (i.e. it is permanent until reversed)
- *Enervation*: (3 Power Points) Target must make a *Vigor* -2 check or gain *Fatigue* levels for each success and *Raise* rolled by the staff's wielder.
- *Chain* effect: Multiply the cost of any power by the total number of people being targeted to affect multiple targets simultaneously. *Example*: To shoot "Chain Purple Lightning" at 3 people would cost 18 Power Points.

Appendix C: Monsters

This list of monsters includes some unique creations along with creatures inspired by the *Savage Worlds* core rules and online resources such as *Savage Free Bestiary*, by Andrea Parducci.

Percentiles are included with each entry so that a monster can be randomly generated if necessary.

Monsters that have ability draining attacks inflict temporary ability damage. Lost ability dice are recovered at a rate of one die per hour.

(01) Adventurer (WC)

Strength: d8	Smarts: d6	Agility: d8	Spirit: d8	Vigor: d8
Pace: 6	Parry: 6	Toughness: 6	Fighting: d8	
Gear & Weapons: Bash (STR)				
Edges & Powers: <i>Luck</i> (1 extra <i>Benny</i>); <i>Alertness</i> (+2 to <i>Notice</i> checks)				

This is another adventurer, much like yourself, who happens to be down on his luck. He'd be willing to join up with you for a fair share of the spoils.

(02) Air Mephit

Strength: d4	Smarts: d6	Agility: d10	Spirit: d6	Vigor: d6
Pace: 6 (Fly)	Parry: 6	Toughness: 4	Fighting: d8	
Gear & Weapons: Claws (STR + d4)				
Edges & Powers: <i>Air Blast</i> (cone template; all targets in area must make a <i>Strength</i> -2 check or be <i>Shaken</i>); <i>Fly</i> (can fly at Pace 6); <i>Immune to Cold</i> ; <i>Invisibility</i> (can turn invisible as a standard action)				
Imp-like beings from the Elemental Plane of Air.				

(03-04) Arachnaur

Strength: d10	Smarts: d6	Agility: d10	Spirit: d6	Vigor: d8
Pace: 8	Parry: 6	Toughness: 7	Fighting: d8	
Gear & Weapons: Bite (STR + d4)				
Edges & Powers: <i>Poison</i> (targets that are bit must make a <i>Vigor</i> -2 check or become paralyzed for 1d6 rounds); <i>Web Blast</i> (3/6/12 Range; Small Blast Template AoE; webbed targets are immobilized and make all rolls at -4; webs have a <i>Toughness</i> of 7)				

These diabolical hybrids have the lower body of a wolf spider and the upper torso of a man. They are cruel and merciless hunters. Arachnaurs are considered holy figures in certain evil religions.

(05) Arcane Ooze

Strength: d6	Smarts: d4(A)	Agility: d4	Spirit: d6	Vigor: d6
Pace: 2	Parry: 5	Toughness: 6	Fighting: d6	
Gear & Weapons: None				
Edges & Powers: <i>Acidic Touch</i> (+2 to hit; 2d6 points of Acid damage; corrodes metal); <i>Drain Mana</i> (+2 to hit; drains 1d6 Power Points); <i>Ooze</i> (+2 to recover from <i>Shaken</i> ; immune to poison, disease, edged weapons, fire and cold; can squeeze through small openings); <i>Wall Walker</i>				

These glowing, bright green blobs are usually produced from magical accidents. Their touch flenses flesh and mana alike.

(06) Archanid

Strength: d10	Smarts: d12	Agility: d10	Spirit: d8	Vigor: d8
Pace: 6	Parry: 7	Toughness: 6	Fighting: d10	Spellcasting: d12
Gear & Weapons: Bite (STR + d6)				
Edges & Powers: <i>Poison</i> (targets that are bitten must make a <i>Vigor</i> -2 check or suffer 2d10 points of Acid damage); <i>Web Blast</i> (3/6/12 Range; Small Blast Template AoE; webbed targets are immobilized and make all rolls at -4; webs have a <i>Toughness</i> of 7); <i>Wall Walker</i>				
Spells (20 Power Points): <i>Phantasm</i> (4), <i>Puppet</i> (3), <i>Phantasmal Nemesis</i> (5), <i>Fear</i> (2), <i>Invisibility</i> (5)				

The man-sized spiders are intelligent spell-casters from a far-off, mysterious jungle continent. Their bodies are garishly colored with yellow, green, blue and red markings.

(07-08) Armored Phantoms

Strength: d6	Smarts: d4	Agility: d6	Spirit: d4	Vigor: NA
Pace: 6	Parry: 5	Toughness: 8 (2)	Fighting: d6	
Gear & Weapons: Short Sword (STR + d6); Plate Mail (Armor +6)				
Edges & Powers: <i>Undead</i> (+2 to recover from <i>Shaken</i> ; +2 <i>Toughness</i> ; immune to called shots)				

Floating suits of armor animated by necromantic energy.

(09) Balrog (WC)

Strength: d12+4	Smarts: d8	Agility: d8	Spirit: d12	Vigor: d12
Pace: 6 (Fly 10)	Parry: 6	Toughness: 13(10)	Fighting: d12	

Gear & Weapons: Flaming Sword (STR+d10+d6 Fire); Flaming Whip (STR+d6 Fire; +2 <i>Reach</i>)
Edges & Powers: <i>Two Fisted</i> (can make 2 melee attacks per round); <i>Flight</i> (can fly at <i>Pace</i> 10); <i>Fire Aura</i> (all adjacent targets take 2d6 Fire damage per round and have a 1 in 6 chance of combusting); <i>Weakness: Holy Damage</i> (Holy Weapons inflict an extra 1d6 damage); <i>Demon</i> (+2 to recover from <i>Shaken</i> ; immune to disease and poison; 1/2 damage from normal weapons)

A 10' tall black skinned, bull headed demon wreathed in an aura of flame. Clutches a massive flaming sword in one hand and a wicked cat o' nine tails in the other. When a Balrog is slain, their weapons lose their fiery properties.

(10-11) Bison

Strength: d12+2	Smarts: d4(A)	Agility: d6	Spirit: d8	Vigor: d12
Pace: 7	Parry: 4	Toughness: 10	Fighting: d4	
Gear & Weapons: Bash (STR)				
Edges & Powers: <i>Gore</i> (if the Bison moves its full <i>Pace</i> before attacking it can inflict +4 Damage)				

Buffalo meat is a tasty and lean alternative to beef.

(12) Black Knight (WC)

Strength: d12	Smarts: d6	Agility: d8	Spirit: d8	Vigor: d10
Pace: 6	Parry: 9	Toughness: 13(7)	Fighting: d10	
Gear & Weapons: Plate Mail (Armor +6); Balefire Great Sword (STR+d10 damage; 1 in 6 chance of combusting)				
Edges & Powers: <i>Arcane Resistance</i> (+2 <i>Toughness</i> vs. Magic); <i>Demon</i> (+2 to recover from <i>Shaken</i> ; immune to disease and poison; 1/2 damage from normal weapons); <i>Weakness: Cold Iron</i> (take normal damage from Cold Iron weapons); <i>Improved Frenzy</i> ; <i>Improved Block</i> ; <i>Improved Sweep</i> ; <i>Level Headed</i>				

A 7' tall demonic warrior clad in black iron plate mail. Its eyes glow green from within its visored helm and black flames flicker along the edge of its menacing great sword. When a Black Knight is slain its body is incinerated, destroying its weapon and armor.

(13-14) Black Pudding

Strength: d6	Smarts: d4	Agility: d4	Spirit: d4	Vigor: d6
Pace: 4	Parry: 5	Toughness: 9	Fighting: d4	
Gear & Weapons: None				
Edges & Powers: <i>Acid Touch</i> (+2 to hit; 2d8 Acid damage); <i>Corrosion</i> (66% chance of corroding a metal item on touch); <i>Invulnerable</i> (can only be harmed by Fire); <i>Ooze</i> (+2 to recover from <i>Shaken</i> ; immune to called shots, poison and disease; can't be flanked; can squeeze through holes); <i>Wall Walker</i>				

A glistening black 5' x 20' blob of oozing death.

(15) Blood Golem

Strength: d12	Smarts: d4	Agility: d6	Spirit: d10	Vigor: d10
Pace: 6	Parry: 6	Toughness: 7	Fighting: d8	Guts: -4
Gear & Weapons: Bash (STR)				
Edges & Powers: <i>Blood Drain</i> (every time the Blood Golem inflicts a <i>Wound</i> , it grows by one size category); <i>Construct</i> (+2 to recover from <i>Shaken</i> ; immune to called shots, disease and poison; 1/2 damage from piercing); cannot <i>Sprint</i> ; <i>Arcane Resistance</i> (+2 <i>Toughness</i> vs. Magic); <i>Gruesome Appearance</i> (when someone sees a Blood Golem for the first time they must succeed a <i>Guts</i> -4 check or become <i>Shaken</i>)				

Blood Golems look like Flesh Golems that have had their skin flayed off, leaving behind a glistening layer of gore and vitria. They grow stronger as they inflict damage on the living.

Size Category	Height	Statistics
---------------	--------	------------

0	Man-sized (5-6')	No Modifier. This is the Blood Golem's normal size.
1	Athlete-sized (7')	<i>Strength: d12+1; Toughness: 8</i>
2	Bear-sized (8')	<i>Strength: d12+2; Toughness: 9</i>
3	Ogre-sized (9'-10')	<i>Strength: d12+3; Toughness: 10</i>
4	Giant-sized (12'-15')	<i>Strength: d12+4; Toughness: 11.</i> This is the Blood Golem's maximum size.

(16) Bone Golem

Strength: d8	Smarts: d4	Agility: d8	Spirit: d8	Vigor: d8
Pace: 8	Parry: 7	Toughness: 9(7)	Fighting: d10	
Gear & Weapons: Falchions (STR + d8)				
Edges & Powers: <i>Armor +2; Construct</i> (+2 to recover from <i>Shaken</i> ; immune to called shots, disease and poison; 1/2 damage from piercing); <i>Arcane Resistance</i> (+2 <i>Toughness</i> vs. Magic); <i>Multiple Limbs</i> (can make 4 melee attacks per round with no multi-action penalty); cannot <i>Sprint</i>				

Fashioned from the bones of humanoids splinted together with metal and necromancy, bone golems are often constructed with multiple arms allowing them to wield an array of weapons.

(17) Cambion Demon (WC)

Strength: d8	Smarts: d10	Agility: d8	Spirit: d10	Vigor: d8
Pace: 6	Parry: 6	Toughness: 6	Fighting: d8	Charisma: +2
Gear & Weapons: Bash (STR)				
Edges & Powers: <i>Demon</i> (+2 to recover from <i>Shaken</i> ; immune to disease and poison; 1/2 damage from normal weapons)				

Cambions are the half-blooded offspring of humans and demons. Usually the child of a succubus or incubus, Cambions are generally very attractive in spite of the tell-tale calling cards of their infernal parentage. They do not suffer the same inherent weaknesses as full-blooded demons.

(18) Cenobite (WC)

Strength: d8	Smarts: d12	Agility: d8	Spirit: d12	Vigor: d10
Pace: 6	Parry: 6	Toughness: 9 (7)	Fighting: d8	Guts: -2
Gear & Weapons: Blades (STR+d6); Spiked Leather (Armor +2); Spiked Chain (Reach +2; STR+d6 damage)				
Edges & Powers: <i>Pleasure in Pain</i> (Wound penalties provide bonuses instead); <i>Fear Aura</i> (when someone sees a Cenobite for the first time they must succeed a <i>Guts -2</i> check or become <i>Shaken</i>); <i>Weakness: Holy Damage</i> (Holy Weapons inflict an extra 1d6 damage); <i>Demon</i> (+2 to recover from <i>Shaken</i> ; immune to disease and poison; 1/2 damage from normal weapons)				

These grim, pale-skinned demons are wrapped in chains and black leather. Their flesh has been exquisitely mortified by their own hands. They are masters of torture and inflicting pain.

(19-20) Cave Fisher

Strength: d8	Smarts: d4(A)	Agility: d6	Spirit: d6	Vigor: d8
Pace: 6	Parry: 5	Toughness: 8(6)	Fighting: d6	
Gear & Weapons: Bite (STR + d8)				
Edges & Powers: <i>Wall Walker</i> (can scale any surface at their normal Pace); <i>Adhesive Lure</i> (+2 to hit; make an <i>Agility -2</i> check or become stuck to the Cave Fisher's lure; Fisher reels targets in by 10' per round; lure has a <i>Toughness</i> of 8 and is vulnerable to fire and alcohol)				

These large, beetle-like insects lurk on the ceilings of caverns and use their adhesive lures to snare unwary passers-by.

(21-22) Clay Golem

Strength: d12+4	Smarts: d4	Agility: d4	Spirit: d12	Vigor: d10
Pace: 6	Parry: 6	Toughness: 14(9)	Fighting: d8	
Gear & Weapons: Bash (STR)				
Edges & Powers: <i>Improved Arcane Resistance</i> (+4 Toughness vs. Magic); <i>Construct</i> (+2 to recover from <i>Shaken</i> ; immune to called shots, disease and poison; 1/2 damage from piercing); cannot <i>Sprint</i> ; <i>Cursed Wounds</i> (any <i>Wounds</i> inflicted by a Clay Golem can only be healed by magic); <i>Armor</i> +5				

A 10' tall brute fashioned from modeling clay and given the semblance of life by a mad wizard. Will pursue intruders unceasingly until they are ground into paste.

(23) Cloak Wraith

Strength: d8	Smarts: d6(A)	Agility: d6	Spirit: d6	Vigor: d8
Pace: 2	Parry: 5	Toughness: 6	Fighting: d6	Stealth: d12
Gear & Weapons: Choke (STR)				
Edges & Powers: <i>Drain Life</i> (+2 to hit; make a <i>Vigor</i> -2 roll or lose one die of <i>Strength</i> and gain a <i>Fatigue</i> level); <i>Magic Aura</i> (project an aura of magical enchantment); <i>Wall Walker</i> ; <i>Grapple</i> +4				

Contrary to their name, these magical beasts are not undead at all but resemble air-breathing manta rays that have been mutated to look like simple garments. They exude a weak magical aura to trick unsuspecting adventurers into thinking they are enchanted robes or cloaks. These patient hunters will wait for the most opportune time to begin draining their hosts.

(24) Demonic Ape

Strength: d12+1	Smarts: d6 (A)	Agility: d8	Spirit: d6	Vigor: d8
Pace: 8(6)	Parry: 6	Toughness: 8	Fighting: d8	Climbing: d10
Gear & Weapons: Bash (STR)				
Edges & Powers: <i>Demon</i> (+2 to recover from <i>Shaken</i> ; immune to disease and poison; 1/2 damage from normal weapons); <i>Leaping</i> (can broad jump 4 squares +2 for every success and <i>Raise</i> on their <i>Strength</i> roll); <i>Brachiation</i> (can move via swinging at a <i>Pace</i> of 6)				

Demon-blooded apes appear like normal simians in most respects but have glowing red eyes, jet black fur and a pointed tail.

(25) Doppelganger

Strength: d6	Smarts: d10	Agility: d8	Spirit: d8	Vigor: d6
Pace: 6	Parry: 5	Toughness: 5	Fighting: d6	
Gear & Weapons: Bash (STR)				
Edges & Powers: <i>Shapeshifter</i> (can flawlessly imitate any man-sized creature with a <i>Smarts</i> roll; for every <i>Raise</i> the deception imposes a -2 penalty to any <i>Notice</i> attempts); <i>Mind Eater</i> (if the Doppelganger eats the brain of a sentient being, it gains their memories and knowledge for 24 hours)				

In their natural state these creatures are gray skinned and emaciated with large, pupil-less eyes. Their origin is completely alien but their behavior suggests that their ultimate goal is the infiltration and domination of all civilized life.

(26-27) Evil Human

Strength: d6	Smarts: d6	Agility: d6	Spirit: d6	Vigor: d8
Pace: 6	Parry: 5	Toughness: 7(6)	Fighting: d6	
Gear & Weapons: Sword (STR + d6); Leather Armor (Armor +1)				
Edges & Powers: None				

Your typical mercenary scum. Farkinwald hires these goons to handle the most menial tasks around his abode.

(28) Eye Tyrant (WC)

Strength: d6	Smarts: d12	Agility: d6	Spirit: d10	Vigor: d8
Pace: 6 (Fly)	Parry: 5	Toughness: 9 (6)	Fighting: d6	
Gear & Weapons: Bite (STR + d4)				
Edges & Powers: <i>Eye Beams</i> (12 square range; target must make an <i>Agility</i> -2 check to dodge a beam; see below for beam effects); <i>Anti-Magic Gaze</i> (generates a cone-shaped anti-magic field from its center eye; all magic and magic items are suppressed in this field); <i>Level Headed</i> (act on best of 2 initiative cards); <i>Quick</i> (redraw any initiative card that is equal to or less than 5); <i>Fly</i> (Pace 6); <i>Armor</i> +3				

Eye Tyrants are among the most dreaded monsters in the entire world. These floating, 6' diameter globes sport one large central eye and eight smaller eyes on stalks. Each stalk can fire a beam of deadly energy every round. The eyes of the Eye Tyrant are vulnerable to called shots.

Beam	Beam Color	Effect
<i>Disintegration</i>	Sickly Green	Make a <i>Vigor</i> -2 check or get turned into a pile of dust; if you pass the check you still sustain 2d10 points of damage.
<i>Slow</i>	Light Blue	Target's <i>Pace</i> is reduced by half and they act last of initiative for 3 rounds.
<i>Heat Ray</i>	Red	Target sustains 3d8 points of heat damage
<i>Fear</i>	Violet	Make a <i>Spirit</i> -2 check or flee at maximum speed for 3 rounds
<i>Petrification</i>	Yellow	Make a <i>Vigor</i> -2 check or be turned to stone permanently.
<i>Telekinesis</i>	Invisible	Target is lifted into the air and held in suspension for as long as the Eye Tyrant maintains concentration. Target cannot move but can still attack.
<i>Sleep</i>	Sparkly	Make a <i>Spirit</i> -4 check or fall into an instant slumber. Sleeping characters are <i>Shaken</i> when roused.
<i>Death Ray</i>	Black	Make a <i>Vigor</i> -4 check or die

(29) Farkinwald the Fantastic (WC)

Strength: d6	Smarts: d12+2	Agility: d6	Spirit: d12	Vigor: d6
Pace: 6	Parry: 9(5)	Toughness: 7	Fighting: d6	
Gear & Weapons: <i>Staff of Zot</i> (see "Artifacts"), <i>Amulet of Time Stop</i> (freeze time for 3 rounds; 3/day), <i>Robe of Invulnerability</i> (immune to normal weapons), <i>Ring of Greater Arcane Resistance</i> (+4 <i>Toughness</i> vs. Magic), <i>Ring of Elemental Resistance</i> (+4 <i>Toughness</i> vs. Elemental Damage), <i>Bracers of Deflection</i> (+4 <i>Dodge/Parry</i>), <i>Bloodstone Belt</i> (absorbs 4 <i>Wounds</i>)				
Edges & Powers: <i>Quick</i> (redraw initiative cards of 5 or less); <i>Improved Level Headed</i> (draw 3 initiative cards, <i>Improved Tough as Nails</i> (+2 <i>Toughness</i>))				
Spells (60 Power Points): <i>All Spells</i>				

Farkinwald is a very powerful wizard. Even though he is physically weak he has an array of magical defenses at his disposal (and most especially his artifact, the *Staff of Zot*).

(30-31) Fire Bats

Strength: d4	Smarts: d4(A)	Agility: d8	Spirit: d6	Vigor: d6
Pace: 12 (Fly)	Parry: 4	Toughness: 2	Fighting: d4	
Gear & Weapons: Bite (STR)				
Edges & Powers: <i>Lesser Fire Aura</i> (all adjacent targets take 2d4 Fire damage per round and have a 1 in 6				

chance of combusting); *Fly* (Pace 12); *Sonar* (bats can see in absolute darkness but suffer a -4 to hit stationary targets)

Bats from the Elemental Plane of Fire.

(32) Fire Giant

Strength: d12+4	Smarts: d6	Agility: d6	Spirit: d6	Vigor: d10
Pace: 8	Parry: 6	Toughness: 14(12)	Fighting: d8	
Gear & Weapons: Oversized War Maul (STR + d12); Chain Mail (Armor +2)				
Edges & Powers: <i>Fire Aura</i> (all adjacent targets take 2d6 Fire damage per round and have a 1 in 6 chance of combusting); <i>Immune to Fire</i> ; <i>Improved Sweep</i> ; <i>Weakness: Cold</i> (Cold attacks inflict +4 damage)				

This bronze-skinned, red-haired giant stands about 20' tall. The air around the giant is distorted by the heat coming off of him.

(33) Flesh Golem

Strength: d12	Smarts: d4	Agility: d6	Spirit: d10	Vigor: d10
Pace: 6	Parry: 6	Toughness: 8(7)	Fighting: d8	Guts: -2
Gear & Weapons: Bash (STR)				
Edges & Powers: <i>Armor +1</i> ; <i>Construct</i> (+2 to recover from <i>Shaken</i> ; immune to called shots, disease and poison; 1/2 damage from piercing); cannot <i>Sprint</i> ; <i>Arcane Resistance</i> (+2 <i>Toughness</i> vs. Magic); <i>Fearsome Appearance</i> (when someone sees a Flesh Golem for the first time they must succeed a <i>Guts</i> -2 check or become <i>Shaken</i>); <i>Berserk</i> (can reduce <i>Parry</i> by 2 to increase damage rolls by 2)				

Among the simplest sort of golems to make, these amalgams of corpse-parts are still fearsomely strong and resilient.

(34) Fomorian Giant

Strength: d12+3	Smarts: d4	Agility: d6	Spirit: d6	Vigor: d10
Pace: 7	Parry: 6	Toughness: 12(11)	Fighting: d6	
Gear & Weapons: Leather Armor (Armor +1); Hot Poker (STR + d4; 1 in 6 chance of combusting)				
Edges & Powers: <i>Improved Sweep</i> ; <i>Clueless</i> (-2 to all <i>Knowledge</i> rolls);				

These misshapen giants sport a range of congenital deformities. Their twisted bodies usually grow to about 15' tall.

(35) Frost Giant

Strength: d12+3	Smarts: d6	Agility: d6	Spirit: d8	Vigor: d10
Pace: 8	Parry: 6	Toughness: 12(11)	Fighting: d8	
Gear & Weapons: Great Axe (STR + d10); Thick Furs (Armor +1)				
Edges & Powers: <i>Cold Aura</i> (all adjacent targets take 2d6 Cold damage per round); <i>Immune to Cold</i> ; <i>Improved Sweep</i> ; <i>Weakness: Fire</i> (Fire attacks inflict +4 damage)				

These white-skinned, blue-eyed hulks grow to about 15' in height. In the frozen parts of the world they maintain vast jarldoms.

(36-37) Gargoyle

Strength: d10	Smarts: d4	Agility: d8	Spirit: d6	Vigor: d10
Pace: 4(10)	Parry: 6	Toughness: 9(7)	Fighting: d10	
Gear & Weapons: Claws (STR + d4)				
Edges & Powers: <i>Armor +2</i> ; <i>Camouflage</i> (+2 <i>Stealth</i> when in rocky terrain); <i>Fly</i> (can fly at a <i>Pace</i> of 10)				

Winged predators with a natural camouflage that allows them to blend into stone surroundings with ease. Their preferred hunting tactic is to select a high vantage point where they can imitate a boulder or a statue and wait for prey to pass below.

(38) Gold Golem (WC)

Strength: d12+2	Smarts: d10	Agility: d6	Spirit: d8	Vigor: d12
Pace: 6	Parry: 8	Toughness: 12 (9)	Fighting: d12	
Gear & Weapons: Great Sword (STR + d10)				
Edges & Powers: <i>Armor +3</i> ; <i>Construct</i> (+2 to recover from <i>Shaken</i> ; immune to called shots, disease and poison; 1/2 damage from piercing; ignore <i>Wound</i> penalties); cannot <i>Sprint</i> ; <i>Improved Arcane Resistance</i> (+4 <i>Toughness</i> vs. Magic); <i>Blood of Fire</i> (when a Gold Golem is <i>Wounded</i> , the attacker must succeed an <i>Agility -2</i> check or suffer 2d6 points of Fire damage from the golem's molten blood)				

These exceptionally rare golems are gifted with sentience as well as supernatural toughness. They are of a size with Iron Golems (about 10' tall and 6000 pounds). When a Gold Golem is defeated it melts down into a pile of gold slag worth about 96,000 gold pieces.

(39) Gorgon

Strength: d8	Smarts: d8	Agility: d8	Spirit: d8	Vigor: d8
Pace: 6	Parry: 5	Toughness: 6	Fighting: d6	
Gear & Weapons: Bash (STR); Serpent Bite (d4+2)				
Edges & Powers: <i>Petrifying Gaze</i> (make an <i>Agility -4</i> check or be turned to stone; can blind-fight to avoid making eye contact); <i>Serpent Hair</i> (can attack all adjacent targets; bitten targets must make a <i>Vigor -2</i> check or become Incapacitated by <i>Fatigue</i>)				

These once beautiful women were cursed by the Gods for their pride and turned into hideous, serpent haired hags. Crueler still, their visage, which once set hearts racing, now turns them to stone.

(40-41) Grave Guardian

Strength: d12	Smarts: d6	Agility: d6	Spirit: d10	Vigor: d12
Pace: 6	Parry: 7	Toughness: 10	Fighting: d10	Guts: -2
Gear & Weapons: Claws (STR + d6)				
Edges & Powers: <i>Undead</i> (+2 to recover from <i>Shaken</i> ; +2 <i>Toughness</i>); <i>Fast Regeneration</i> (make a <i>Vigor</i> check each round to heal 1 <i>Wound</i> ; Cold Iron prevents this); <i>Weakness: Cold Iron</i> (damaged normally by Cold Iron); <i>Arcane Resistance</i> (+2 <i>Toughness</i> vs. Magic); <i>Fearsome Appearance</i> (when someone sees a Grave Guardian for the first time they must succeed a <i>Guts -2</i> check or become <i>Shaken</i>)				
Spells (15 Power Points): <i>Armor</i> , <i>Burrow</i> , <i>Detect Arcana</i> , <i>Environmental Protection</i> , <i>Fear</i> , <i>Obscure</i>				

These powerful undead beings were originally created by a sect of Death-worshipping clerics to guard against tomb robbers. They are terrifying to behold with emaciated, blackened bodies, unnaturally long claws and long, flowing funeral shrouds.

(42) Grell

Strength: d6	Smarts: d10	Agility: d8	Spirit: d10	Vigor: d6
Pace: 6 (Fly)	Parry: 6	Toughness: 6	Fighting: d8	
Gear & Weapons: Bite (STR + d6)				
Edges & Powers: <i>Fly</i> (Grell can levitate at <i>Pace</i> 6); <i>Paralyzing Touch</i> (+2 to hit; make a <i>Vigor -2</i> save or be paralyzed for 3 rounds); <i>Improved Frenzy</i> (can make 2 attacks per round); <i>Tentacles</i> (Reach +1)				

These alien beasts look like man-sized floating brains with a sharp beak protruding from the underside and six long tentacles trailing beneath. They are not natives to this plane of existence.

(43) Grue

Strength: d10	Smarts: d6	Agility: d8	Spirit: d10	Vigor: d10
Pace: 6	Parry: 6	Toughness: 7	Fighting: d8	
Gear & Weapons: Claw/Bite (STR +d6)				
Edges & Powers: <i>Infravision</i> (can see in the dark); <i>Weakness: Light</i> (Grues run in fear from light; sunlight inflicts 2d8 points of damage per round); <i>Level Headed</i> (acts on best of 2 initiative cards); <i>No Infravision</i> signature (cannot be seen by <i>Night Vision</i>)				

Grues are terrors that lurk in absolute darkness. Though humanoid in form, their long, spindly limbs, black carapaces, underdeveloped eyes and huge slavering jaws give them a distinctly alien appearance. These creatures derive tremendous pleasure from stalking prey before moving in for the kill.

(44) Hellcat

Strength: d12	Smarts: d8	Agility: d8	Spirit: d10	Vigor: d8
Pace: 8	Parry: 6	Toughness: 8	Fighting: d8	
Gear & Weapons: Claws/Bite (STR + d6)				
Edges & Powers: <i>Demon</i> (+2 to recover from <i>Shaken</i> ; immune to disease and poison; 1/2 damage from normal weapons); <i>Unlucky Touch</i> (+2 to hit; touch attack causes target to lose 1 <i>Benny</i>); <i>Growth</i> (can grow to lion size as a standard action); <i>Improved Frenzy</i> (can make 2 attacks per round); <i>Pounce</i> (can leap 1d6 squares, gaining a +4 bonus to attack but a -2 to <i>Parry</i> for one round); <i>Weakness: Cold Iron</i> (take normal damage from Cold Iron weapons)				

These otherwise normal looking black house cats are actually demonic beings who are sometimes take by evil wizards as familiars and bodyguards. In battle they grow to the size of an adult lion.

(45-48) Hobgoblin

Strength: d8	Smarts: d6	Agility: d6	Spirit: d10	Vigor: d8
Pace: 6	Parry: 7(6)	Toughness: 8(6)	Fighting: d8	
Gear & Weapons: Falchion (STR + d8); Splint Armor (Armor +2); Normal Shield (Parry +1); Heavy Bow (10/20/40 Range; 2d6+1 damage)				
Edges & Powers: <i>Infravision</i> (can see in the dark)				

Generations of selective breeding have produced this race of ideal soldiers. Their mixed orcish, goblin and human heritage gives them a unique blend of strength, discipline and viciousness.

(49) Intellect Devourer

Strength: d8	Smarts: d6	Agility: d8	Spirit: d10	Vigor: d8
Pace: 10	Parry: 6	Toughness: 6	Fighting: d8	
Gear & Weapons: Claw (STR+d4)				
Edges & Powers: <i>Stupefying Touch</i> (+2 to hit; <i>Spirit</i> -2 or lose a die of both <i>Smarts</i> and <i>Spirit</i>); <i>Stunning Blast</i> (can fire a cone shaped blast of psionic energy to disorient foes; <i>Spirit</i> -2 or become <i>Shaken</i>)				

These wolf-sized quadrupeds have oversized brain-like protuberances where their heads should be. They feed only on mental energy and are a bane to spellcasters everywhere.

(50) Invisible Stalker (WC)

Strength: d8	Smarts: d8	Agility: d10	Spirit: d8	Vigor: d10
Pace: 6 (Fly 30)	Parry: 6	Toughness: 7	Fighting: d8	Stealth: d10
Gear & Weapons: Claws (STR+d6)				
Edges & Powers: <i>Invisible</i> (completely invisible, even while attacking; -4 to be hit); <i>Fly</i> (can fly at <i>Pace</i> 30)				

These completely invisible beings of Elemental Air are often summoned to serve as perfect killers for nefarious warlocks.

(51) Iron Golem

Strength: d12+3	Smarts: d4	Agility: d6	Spirit: d8	Vigor: d12+1
Pace: 6	Parry: 6	Toughness: 15 (9)	Fighting: d10	
Gear & Weapons: Bash (STR+d6)				
Edges & Powers: <i>Armor</i> +6; <i>Construct</i> (+2 to recover from <i>Shaken</i> ; immune to called shots, disease and poison; 1/2 damage from piercing); cannot <i>Sprint</i> ; <i>Improved Arcane Resistance</i> (+4 <i>Toughness</i> vs. Magic); <i>Improved Sweep</i> (can make <i>Sweep</i> attacks with no penalty)				

Weighing 6000 pounds and standing at a ceiling scraping 10' tall, Iron Golems are walking battering rams.

(52) "The Janitor" Gelatinous Cube (WC)

Strength: d8	Smarts: N/A	Agility: d4	Spirit: d6	Vigor: d8
Pace: 2	Parry: 2	Toughness: 10	Fighting: N/A	
Gear & Weapons: None				
Edges & Powers: <i>Paralyzing Touch</i> (<i>Vigor</i> +2 or be paralyzed for 2d6 rounds); cannot <i>Sprint</i> ; <i>Consumption</i> (Envelopes and grapples anything it moves on to; +4 to all <i>Grapple</i> rolls); <i>Digestive Acid</i> (anyone <i>Grappled</i> by the Cube suffers 2d10 Acid damage per round)				

A translucent 10' by 10' cube that perfectly fills the corridors in Castle Farkinwald. This ooze patrols the hallways cleaning out the corpses of dead adventurers.

(53-54) Kobold

Strength: d4	Smarts: d4	Agility: d10	Spirit: d6	Vigor: d6
Pace: 6	Parry: 4	Toughness: 4	Fighting: d4	Shooting: d8
Gear & Weapons: Short Bow (2d4 damage; 10/20/40 range); Javelin (STR+d4)				
Edges & Powers: <i>Infravision</i> (can see in the dark); <i>Sprint</i> (roll a d10 when <i>Sprinting</i>); <i>Cunning</i> (+2 to all <i>Stealth</i> and <i>Taunt</i> rolls); <i>Cowardly</i> (will only fight while the odds are in their favor)				

Most adventurers consider these small, scaly reptilian humanoids little better than common vermin, but in sufficient numbers they can present a challenge to all but the most hardy dungeon delvers.

(55) Lich (WC)

Strength: d10	Smarts: d12+2	Agility: d6	Spirit: d10	Vigor: d10
Pace: 6	Parry: 6	Toughness: 15(9)	Fighting: d8	Spellcasting: d12
Gear & Weapons: None				
Edges & Powers: <i>Magical Armor</i> +6; <i>Death Touch</i> (+2 to hit; each <i>Raise</i> inflicts 1 <i>Wound</i>); <i>Undead</i> (+2 <i>Toughness</i> ; +2 to recover from <i>Shaken</i> ; Immune to Called Shots; ignore <i>Wound</i> penalties); <i>Zombie Master</i> (any <i>Zombies</i> created by the Lich are permanent)				
Spells (50 Power Points): <i>Bolt</i> (2; 3d6 damage), <i>Blast</i> (6; 3d6 damage L.B.T.), <i>Puppet</i> (4), <i>Zombie</i> (3), <i>Dispel</i> (3), <i>Fly</i> (6; Pace 12), <i>Teleport</i> (3)				

Liches are Wizards of tremendous power who managed to unlock the secret of undeath.

(56-57) Living Statue

Strength: d10	Smarts: d4	Agility: d6	Spirit: d8	Vigor: d8
Pace: 4	Parry: 5	Toughness: 10 (6)	Fighting: d6	
Gear & Weapons: Bash (STR)				
Edges & Powers: <i>Armor</i> +4; <i>Construct</i> (+2 to recover from <i>Shaken</i> ; immune to called shots, disease and poison; 1/2 damage from piercing); cannot <i>Sprint</i>				

Living Statues are essentially man-sized versions of Stone Golems. They are sometimes made out of other substances, such as quartz crystal.

(58) Magic Eater

Strength: d8	Smarts: d6	Agility: d6	Spirit: d8	Vigor: d8
Pace: 6	Parry: 5	Toughness: 9(6)	Fighting: d6	
Gear & Weapons: Bite (STR)				
Edges & Powers: <i>Anti-Magic Touch</i> (+2 to hit; drain 2d6 Power Points; on a <i>Raise</i> they cause one random magic item to become disenchanting)				

These relatives of the Rust Monster have the same, lobster-like armored appearance but the shells of Magic Eaters are blue, green and purple and instead of feelers they have probing antennae mounted on their heads.

(59) Manticore

Strength: d12+2	Smarts: d6	Agility: d8	Spirit: d8	Vigor: d10
Pace: 8	Parry: 6	Toughness: 9	Fighting: d8	
Gear & Weapons: Claw/Bite (STR + d6)				
Edges & Powers: <i>Improved Frenzy</i> (make 2 attacks per round); <i>Tail Volley</i> (4/8/12 Range; 2d6 damage)				

These chimaeric beasts have the bodies of lions, the head of a man, and a mace-like tail that ends in a ball of spines. They are nearly 10' long tip to tail and weigh around 600 lbs.

(60) Mimic

Strength: d8	Smarts: d6	Agility: d6	Spirit: d8	Vigor: d8
Pace: 4	Parry: 5	Toughness: 8(6)	Fighting: d6	
Gear & Weapons: Bash (STR)				
Edges & Powers: <i>Paralyzing Touch</i> (+2 to hit; make a <i>Vigor</i> -2 check or be immobilized for 3 rounds); <i>Superior Frenzy</i> (can make 3 attacks per round); <i>Armor +2</i> (Rubbery Body)				

Shape-shifting creatures that disguise themselves as common objects.

(61) Mind Flayer (WC)

Strength: d6	Smarts: d12+2	Agility: d6	Spirit: d12+2	Vigor: d8
Pace: 6	Parry: 6	Toughness: 6	Fighting: d8	
Gear & Weapons: None				
Edges & Powers: <i>Stunning Blast</i> (can fire a cone shaped blast of psionic energy to disorient foes; <i>Spirit</i> -4 or become <i>Shaken</i>); <i>Mind Control</i> ; <i>Stupefying Touch</i> (+2 to hit; <i>Spirit</i> -2 or lose a die of both <i>Smarts</i> and <i>Spirit</i>); <i>Devour Brain</i> (when a target has lost all <i>Smarts</i> or <i>Spirit</i> , the Mind Flayer can make a touch attack to slay them); <i>Improved Frenzy</i> (can attack twice per round)				

These octopus-headed terrors are villainous masterminds of the highest order. A Mind Flayer will never sully itself with physical combat, choosing instead to use its superior psionic powers to blast opponents into a stupor so that it can snack on their brains in a leisurely fashion.

(62-63) Minotaur

Strength: d12+2	Smarts: d6	Agility: d8	Spirit: d8	Vigor: d12
Pace: 8	Parry: 8	Toughness: 10	Fighting: d10	
Gear & Weapons: Bash (STR)				
Edges & Powers: <i>Fleet Footed</i> (rolls a d10 when <i>Sprinting</i>); +1 <i>Reach</i> ; <i>Gore</i> (if the Minotaur moves its full <i>Pace</i> before attacking it can inflict +4 Damage)				

Bull-headed man-animal hybrids that stand about 7' tall (not including horns). They are rippling physical specimens.

(64) Mist Vampire (WC)

Strength: NA	Smarts: d10	Agility: d8	Spirit: d10	Vigor: d6
Pace: 6	Parry: 6	Toughness: 7	Fighting: d8	
Gear & Weapons: None				
Edges & Powers: <i>Incorporeal</i> (can pass through solid objects; can only be hit by magic or magic weapons); <i>Life Drain</i> (+2 to hit; make a <i>Vigor</i> -2 check or sustain 1 <i>Wound</i> ; Mist Vampire heals 1 <i>Wound</i>); <i>Undead</i> (+2 to recover from <i>Shaken</i> ; +2 <i>Toughness</i> ; immune to called shots)				

These are vampires who got trapped in gaseous form when their coffins were destroyed.

(65) Mummy

Strength: d12+2	Smarts: d6	Agility: d4	Spirit: d10	Vigor: d12
Pace: 4	Parry: 6	Toughness: 10	Fighting: d8	Guts: 0
Gear & Weapons: Bash (STR)				
Edges & Powers: <i>Arcane Resistance</i> (+2 <i>Toughness</i> vs. Magic); <i>Fearsome Appearance</i> (when someone sees a Mummy for the first time they must succeed a <i>Guts</i> check or become <i>Shaken</i>); <i>Weakness: Fire</i> (suffers +4 damage from fire); <i>Undead</i> (+2 to recover from <i>Shaken</i> ; +2 <i>Toughness</i> ; immune to called shots); <i>Mummy Rot</i> (make a <i>Vigor</i> check when struck or suffer 1 additional <i>Wound</i>)				

Elaborate necromantic rituals have brought these desiccated, embalmed corpses back from the dead. They mercilessly pursue anyone who disturbs their burial chambers.

(66) Mushroom King (WC)

Strength: d12+1	Smarts: d6	Agility: d6	Spirit: d8	Vigor: d10
Pace: 5	Parry: 5	Toughness: 10	Fighting: d6	
Gear & Weapons: Bash (STR)				
Edges & Powers: <i>Spore Blast</i> (can spray spores over a cone shaped area; see the "Fungus Forest" encounter for more details)				

This 10' tall lumbering myconoid (mushroom man) is generally peaceful and will try to communicate using telepathic spores before resorting to any kind of violence.

(67) Nightmare

Strength: d12+4	Smarts: d6(A)	Agility: d6	Spirit: d6	Vigor: d10
Pace: 10	Parry: 6	Toughness: 10	Fighting: d8	
Gear & Weapons: Kick (STR + d6)				
Edges & Powers: <i>Fleet Footed</i> (uses a d10 <i>Sprint</i> die); immune to terrain penalties; <i>Demon</i> (+2 to recover from <i>Shaken</i> ; immune to disease and poison; 1/2 damage from normal weapons); <i>Weakness: Cold Iron</i> (take normal damage from Cold Iron weapons)				

The hooves and eyes of these coal-black demonic horses catch fire when the Nightmare achieves full gallop. They are the steeds of choice for Demon Princes.

(68-69) Ogre

Strength: d12+3	Smarts: d4	Agility: d6	Spirit: d6	Vigor: d12
Pace: 7	Parry: 6	Toughness: 10	Fighting: d8	
Gear & Weapons: Bash (STR)				
Edges & Powers: <i>Sweep</i> (may attack all adjacent foes at -2)				

These brutes may only have a touch of giant blood but they can still break men like twigs, which happens to be their favorite pastime.

(70-71) Owl Bear

Strength: d12+4	Smarts: d6(A)	Agility: d6	Spirit: d8	Vigor: d12
Pace: 8	Parry: 6	Toughness: 10	Fighting: d8	
Gear & Weapons: Claw/Bite (STR + d6)				
Edges & Powers: <i>Hug</i> (if the Owl Bear hits with a <i>Raise</i> , it automatically pins its opponent); <i>Night Vision</i> (can see in the dark); <i>Alertness</i> (+2 to <i>Notice</i> rolls)				

These laboratory monstrosities were created by magically cross-breeding grizzly bears with great horned owls (don't ask why!). They are dauntless hunters.

Red Dragon (WC)

Strength: d12+9	Smarts: d8	Agility: d8	Spirit: d10	Vigor: d12
Pace: 8(24)	Parry: 6	Toughness: 20(16)	Fighting: d10	Guts: -2
Gear & Weapons: Bite/Claw (STR + d8); Tail (STR -2)				
Edges & Powers: <i>Fire Breath</i> (breathes flame in a cone template; all targets must succeed an <i>Agility</i> -2 check or suffer 2d10 points of Fire damage. There's a 2 in 6 chance that affected targets begin burning. Dragons cannot breathe and attack in the same round); <i>Fly</i> (can fly at <i>Pace</i> 24); <i>Scales (Armor +4)</i> ; <i>Fear Aura</i> (characters must succeed a <i>Guts</i> -2 check or become <i>Shaken</i> when they first encounter a dragon); +4 <i>Reach</i> ; <i>Improved Frenzy</i> (2 melee attacks per round at no penalty); <i>Hardy</i> (does not gain <i>Wounds</i> when <i>Shaken</i> more than once); <i>Level Headed</i> (draws twice for initiative); <i>Tail Slap</i> (can make a <i>Sweep</i> attack against all targets on their flank)				

The King of Monsters, the dreaded Red Dragon can lay waste to entire cities with its flaming breath and fearsome strength. These beasts are huge, measuring 40 feet in length and 30 feet in width.

(72) Rock Demon (WC)

Strength: d10	Smarts: d6	Agility: d8	Spirit: d6	Vigor: d10
Pace: 6	Parry: 7	Toughness: 11(7)	Fighting: d10	
Gear & Weapons: Greatsword (STR + d10)				
Edges & Powers: <i>Sundering Skin</i> (any weapon that strikes the Rock Demon has a 2 in 6 chance of chipping, suffering a permanent -1 to damage); <i>Demon</i> (+2 to recover from <i>Shaken</i> ; immune to disease and poison; 1/2 damage from normal weapons); <i>Armor +4</i> ; <i>Block</i>				

These horned, stone-skinned humanoids look a lot like gargoyles but are actually flesh and blood demons. Unlike most demons they are more interested in self-gratification than corrupting mortals.

(73-74) Rust Monster

Strength: d8	Smarts: d6	Agility: d6	Spirit: d8	Vigor: d8
Pace: 6	Parry: 5	Toughness: 9(6)	Fighting: d6	
Gear & Weapons: Bite (STR)				
Edges & Powers: <i>Rusting Touch</i> (+2 to hit; on a <i>Raise</i> they cause one random metal item to corrode, losing one point of armor or damage value); <i>Armor +3</i>				

Rust monsters are odd looking armored quadrupeds about the size of a man. They have long feelers attached to their heads that corrode metal on contact.

(75) Shadow Beast

Strength: NA	Smarts: d6	Agility: d10	Spirit: d10	Vigor: d10
Pace: 10	Parry: 5	Toughness: 7	Fighting: d6	
Gear & Weapons: None				
Edges & Powers: <i>Drain Life</i> (+2 to hit; make a <i>Vigor</i> -2 roll or lose one die of <i>Strength</i> and gain a <i>Fatigue</i> level); <i>Blend with Shadow</i> (can become invisible in any shadow); <i>Fleet Footed</i> (roll d10 when <i>Sprinting</i>);				

Incorporeal (can pass through solid objects; can only be hit by magic or magic weapons)

These malevolent beings hail from the Demi-Plane of Shadow. The life force of living beings is their sweetest nectar.

(76-80) Skeleton

Strength: d6	Smarts: d4	Agility: d8	Spirit: d4	Vigor: d6
Pace: 7	Parry: 5	Toughness: 7	Fighting: d6	
Gear & Weapons: Bash (STR)				
Edges & Powers: <i>Undead</i> (+2 to recover from <i>Shaken</i> ; +2 <i>Toughness</i> ; immune to called shots)				

Animated skeletons, along with zombies, represent the lowest order of the undead.

(81) Skeleton Knight (WC)

Strength: d10	Smarts: d6	Agility: d10	Spirit: d10	Vigor: d12+2
Pace: 6	Parry: 12(10)	Toughness: 17(11)	Fighting: d12	
Gear & Weapons: Longsword (STR +d8); Kite Shield (+2 <i>Parry</i>); Plate Mail (<i>Armor</i> +6)				
Edges & Powers: <i>Undead</i> (+2 to recover from <i>Shaken</i> ; +2 <i>Toughness</i> ; immune to called shots; ignore <i>Wound</i> penalties); <i>Improved Frenzy</i> (can make 2 melee attacks per round); <i>Improved Block</i> (<i>Parry</i> +2)				

Skeleton Knights are the warrior equivalent of a Lich. They are very powerful undead beings with a lifetime of military experience to back up their necromantic strength.

(82) Spectre

Strength: N/A	Smarts: d6	Agility: d8	Spirit: d12	Vigor: d10
Pace: 6	Parry: 6	Toughness: 9	Fighting: d8	Stealth: d12+4
Gear & Weapons: None				
Edges & Powers: <i>Chilling Touch</i> (+2 to hit; <i>Vigor</i> -2 or lose a die of both <i>Strength</i> and <i>Vigor</i>); <i>Incorporeal</i> (can pass through solid objects; can only be hit by magic or magic weapons); <i>Undead</i> (+2 to recover from <i>Shaken</i> ; +2 <i>Toughness</i> ; immune to called shots)				

Evil spirits that hate all life, Spectres are cunning and will use their incorporeality to the utmost advantage, attacking through walls and floors.

(83) Stone Golem

Strength: d12+2	Smarts: d6	Agility: d6	Spirit: d8	Vigor: d12
Pace: 5	Parry: 7	Toughness: 13(9)	Fighting: d10	
Gear & Weapons: Bash (STR+d6)				
Edges & Powers: <i>Armor</i> +4; <i>Construct</i> (+2 to recover from <i>Shaken</i> ; immune to called shots, disease and poison; 1/2 damage from piercing); cannot <i>Sprint</i> ; <i>Improved Arcane Resistance</i> (+4 <i>Toughness</i> vs. Magic)				

These large animated statues stand about 8' tall and weigh 4000 pounds. They are implacable guardians.

(84) Succubus

Strength: d10	Smarts: d8	Agility: d8	Spirit: d10	Vigor: d8
Pace: 6	Parry: 6	Toughness: 6	Fighting: d8	Charisma: +6
Gear & Weapons: Claws (STR + d4)				
Edges & Powers: <i>Demon</i> (+2 to recover from <i>Shaken</i> ; immune to disease and poison; 1/2 damage from normal weapons); <i>Glamour</i> (can make an opposed <i>Spirit</i> roll against a member of the opposite sex to charm them; effect is indefinite but can only affect one target at a time); <i>Weakness: Cold Iron</i> (takes normal damage from Cold Iron); <i>Life Drain</i> (+2 to hit; target must make an opposed roll (<i>Vigor</i> vs. Succubus' <i>Spirit</i>) or lose one die step of <i>Vigor</i>)				

Succubi are allure personified. They represent the embodied reality of every male fantasy. These demons exist solely to tempt mortals and to convince them to surrender their souls in exchange for sensual delights.

(85) Treasure Ooze

Strength: d6	Smarts: d4(A)	Agility: d4	Spirit: d6	Vigor: d6
Pace: 2	Parry: 5	Toughness: 6	Fighting: d6	Stealth: d12
Gear & Weapons: None				
Edges & Powers: <i>Acidic Touch</i> (+2 to hit; 2d6 points of Acid damage; corrodes metal); <i>Paralyzing Touch</i> (+2 to hit; make a <i>Vigor</i> -2 check or become immobilized for 3 rounds); <i>Ooze</i> (+2 to recover from <i>Shaken</i>); immune to poison, disease, edged weapons, fire and cold; can squeeze through small openings); <i>Wall Walker</i>				

Translucent blobs of sticky protoplasm that cover themselves with shiny objects to attract prey.

(86-87) Troll

Strength: d12+2	Smarts: d4	Agility: d6	Spirit: d6	Vigor: d10
Pace: 7	Parry: 6	Toughness: 10(9)	Fighting: d8	
Gear & Weapons: Claws (STR + d4)				
Edges & Powers: <i>Fast Regeneration</i> (make a <i>Vigor</i> check each round to heal 1 <i>Wound</i> ; Fire and Acid prevent this); <i>Rubbery Hide</i> (Armor +1); <i>Infravision</i> (can see in the dark)				

Hideous, 8' tall, green skinned humanoids with a taste for human flesh.

(88-89) Trollhound

Strength: d8	Smarts: d6 (A)	Agility: d8	Spirit: d6	Vigor: d8
Pace: 8	Parry: 6	Toughness: 6(5)	Fighting: d8	
Gear & Weapons: Bite (STR + d4)				
Edges & Powers: <i>Fleet Footed</i> (d10 <i>Sprint</i> die); <i>Go for the Throat</i> (attacks most vulnerable area on a <i>Raise</i>); <i>Fast Regeneration</i> (make a <i>Vigor</i> check each round to heal 1 <i>Wound</i> ; Fire and Acid prevent this); <i>Rubbery Hide</i> (Armor +1)				

Mastiffs with green, rubbery skin and the regenerative properties of a troll. The creations of some mad wizard.

(90-92) Umber Hulk

Strength: d12+3	Smarts: d4	Agility: d6	Spirit: d6	Vigor: d12
Pace: 6	Parry: 6	Toughness: 16(10)	Fighting: d8	
Gear & Weapons: Claw (STR+d6); Bite (STR+d10)				
Edges & Powers: <i>Armor Shell</i> (the shell of the Umber Hulk imparts <i>Armor +6</i>); <i>Improved Frenzy</i> (can make 2 attacks per round); <i>Confusing Gaze</i> (can make a gaze attack to <i>Shaken</i> a target; <i>Spirit</i> -2 to resist); <i>Burrow</i> (can tunnel underground at their normal <i>Pace</i>)				

These 10' tall bipedal insects have carapaces as thick as plate mail, huge mandibles and an arrangement of gem-like compound eyes that can bedazzle anyone who stares into them. Typically found burrowing in the deep earth, Farkinwald has captured some of these dreaded underworld scourges to populate his lair.

(93) Unicorn

Strength: d12+2	Smarts: d8 (A)	Agility: d8	Spirit: d10	Vigor: d10
Pace: 10	Parry: 5	Toughness: 9	Fighting: d6	Power Points: 40
Gear & Weapons: Kick (STR + d6)				
Edges & Powers: <i>Fleet Footed</i> (d10 <i>Sprint</i> die); <i>Force of Good</i> (+2 damage and <i>Toughness</i> vs. Evil)				

creatures); *Healing* (horn heals on contact; can cast *Healing* and *Greater Healing*)

These majestic, magical horses have a flawless white coat, a golden mane and a pearlescent horn sprouting from their forehead. The horn has magical healing properties which continue to function even after it has been removed from the unicorn's body. The act of removing a unicorn's horn displeases the Gods; the butcher who does this suffers a permanent -2 *Charisma* penalty.

(94) Vampiress (WC)

Strength: d12+3	Smarts: d10	Agility: d8	Spirit: d10	Vigor: d12
Pace: 6	Parry: 7	Toughness: 10	Fighting: d10	
Gear & Weapons: Bash (STR)				
Edges & Powers: <i>Undead</i> (+2 to recover from <i>Shaken</i> ; +2 <i>Toughness</i> ; immune to <i>Wound</i> penalties); <i>Glamor</i> (can make an opposed <i>Smarts</i> roll against a member of the opposite sex to charm them; effect is indefinite but can only affect one target at a time); <i>Improved Frenzy</i> (2 attacks per round); <i>Invulnerability</i> (can only be wounded or killed by their weaknesses); <i>Weakness: Sunlight, Holy Water, Stakes, Holy Symbols</i> ; <i>Sire</i> (targets killed by a vampire become vampire thralls in 1d4 days); <i>Level Headed</i> (act on best of 2 initiative cards); <i>Mist Form</i> (make a <i>Smarts</i> -2 check to turn into a fog)				

These chilling beauties are forever preserved by undeath. They see mortals as nothing more than playthings and ambulatory blood supplies. When the mood strikes them, a Vampiress may turn a favored pet into a familiar or a thrall.

(95) Water Elemental

Strength: d10	Smarts: d6	Agility: d8	Spirit: d6	Vigor: d10
Pace: 6	Parry: 6	Toughness: 7	Fighting: d8	
Gear & Weapons: Bash (STR)				
Edges & Powers: <i>Elemental</i> (immune to called shots, disease and poison); <i>Invulnerability</i> (immune to non-magical attacks); <i>Weakness: Fire</i> (sustain 1d6 points of damage from non-magical fire); <i>Ooze</i> (can seep through tiny gaps); <i>Water Blast</i> (cone template; all targets in area must make a <i>Strength</i> -2 check or be <i>Shaken</i>)				

Beings of pure Elemental Water that take crude humanoid form when agitated.

(96-97) Xorn

Strength: d10	Smarts: d4	Agility: d6	Spirit: d6	Vigor: d10
Pace: 4	Parry: 5	Toughness: 11(7)	Fighting: d6	
Gear & Weapons: Claws (STR + d6)				
Edges & Powers: <i>Armor +4</i> ; <i>Superior Frenzy</i> (3 attacks per round); <i>Burrow</i> (can move effortlessly through solid rock); Immune to Fire and Cold; 1/2 damage from Electricity				

These bizarre-looking natives of the Elemental Plane of Earth have an appetite for rare gemstones. They will always sniff out and target individuals carrying gems and jewels. These squat, 5' tall beings walk on three stumpy legs, have three arms and a large snapping mouth located on the top of their bodies. They have no definable head.

(98-00) Zombie

Strength: d6	Smarts: d4	Agility: d6	Spirit: d4	Vigor: d6
Pace: 4	Parry: 5	Toughness: 7	Fighting: d6	
Gear & Weapons: Bash (STR)				
Edges & Powers: <i>Undead</i> (+2 to recover from <i>Shaken</i> ; +2 <i>Toughness</i>); <i>Weakness: Head Shots</i> (a called shot to the head inflicts +2 damage); <i>Fearless</i> ; cannot <i>Sprint</i>				

Shambling, reanimated corpses programmed to kill the living.

Appendix D: Game Aids

Player friendly version of the Menu from *The Banquet*:

Le Menu du jour

Head Chef: Grongdonk Blijosk

Maitre'd: Monsieur Pantalon-Blanc

Appetizers:

Illithid Ceviche

Charcuterie Plate, a Chef's selection of artisanal meats and cheeses

Halfling Pate with Toast Points

Salads:

Spring Greens with Bloodgood's Special Dressing

Tossed Shambling Mound with Umber Hulk Roe

Githyanki Soulaw

Main Course:

Tablesides Roasted Human au Poivre

Stuffed Rust Monster Nymphs

Wyvern Chops in Fireberry Sauce

Myconid Truffle Fettuccini

Dessert:

Black Pudding

Candied Mandrake with Mint Compote

Brandy Poached Pixie Brains

Beverages:

Asmodean Whiskey, aged 666 years

Prismatic Wine, from the Concordant Opposition Vineyard

Undermountain Ale, crafted by the Khazok War Brewery

The gemstone console from the *Throne Room*:

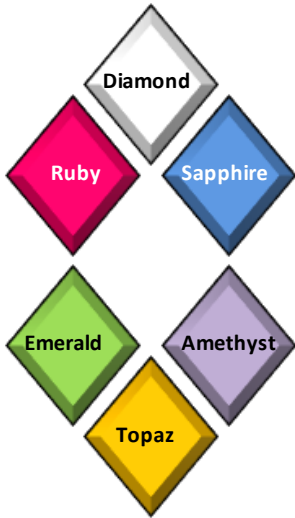

The Tiled Hall:

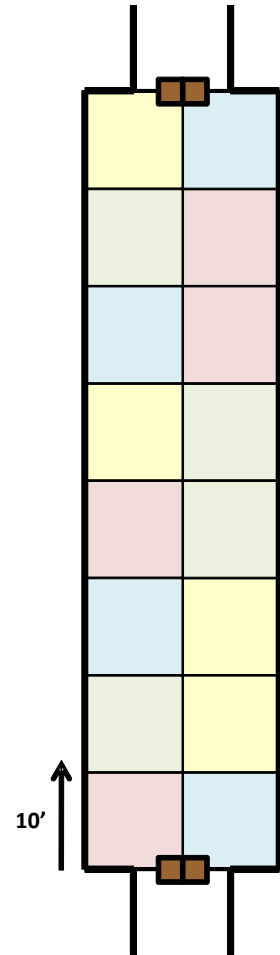

The control panel from *Time Bomb*:



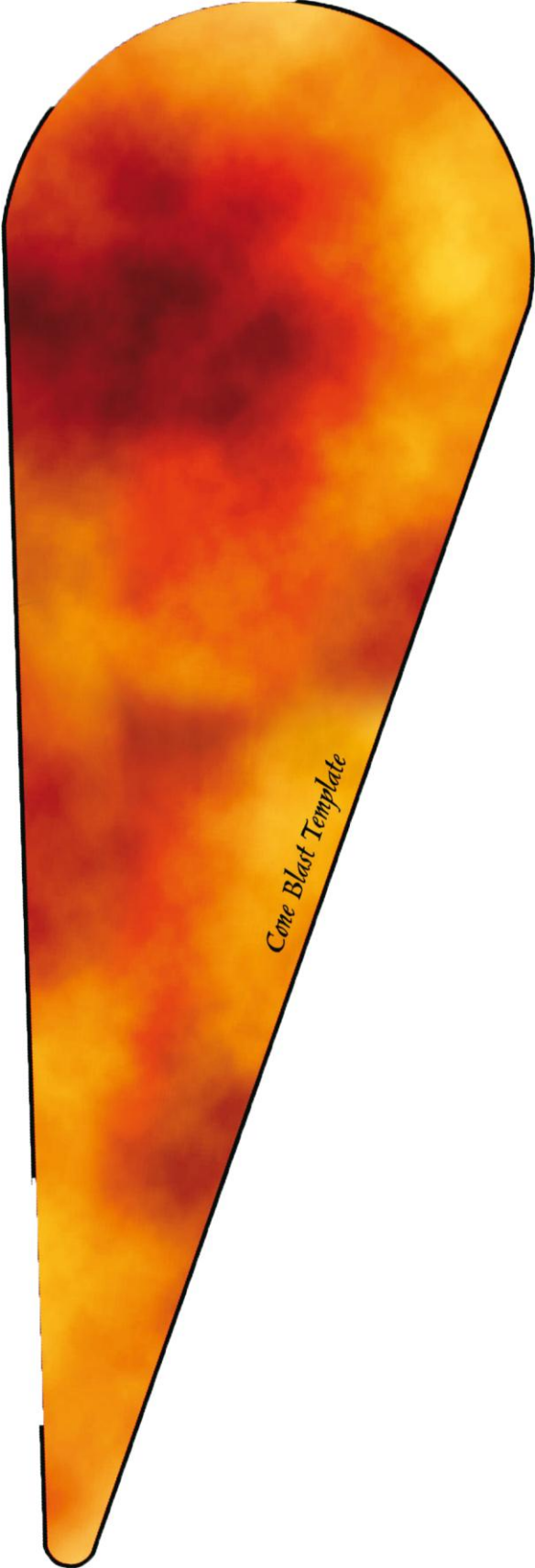

Cone Blast Template