

SILENT DEATH™

#7212P

WARHOUNDS™



**A technology sourcebook for
Silent Death
detailing escort class vessels.**



FIRST CONTACT™

"Alright, people, settle down. We haven't got a clue about what we're up against here. What we believe to be advance elements of their main fleet encountered one of our patrols yesterday morning. Friendly contact was lost, but not before we got an N-sweep of the aggressor vessels," the Ops Commander took a deep breath. "Configuration, unknown. Composition, unknown. Armaments, unknown. Occupants, unknown. Good tech, eh? What a surprise. What we do know is that they waxed our guys, and Deep Scan says more intruders are on the way. Plenty more, and soon. Questions?"

-Briefing segment

NIGHT BROOD™ FIRST CONTACT

First Contact shows the initial confrontation with the Grubs, a bellicose alien race intent on the destruction of mankind. They swarm through deep space ravaging planet after planet. **Night Brood: First Contact** is a revision of the 1992 **Night Brood™** Release.

Night Brood: First Contact includes:

- Rules for using Grub ships and weapons
- Night Brood scenarios
- Brood campaign guidelines
- 188 counters for Brood ships, Drones, Wormholes, and special equipment.
- Displays for 10 Brood ships
 - Muskellunge
 - Squidge
 - Manta
 - Dragonfly
 - Shaggai
 - Larva
 - Lamprey
 - Remora
 - Tigermoth
 - Thistle

SILENT DEATH™
THE NEXT MILLENNIUM



Produced
and Distributed by:

 ICE, Inc.
P.O. Box 1605
Charlottesville, VA 22902 USA

and
distributed
in the UK by

 HobbyGames LTD
Unit S4, Rudford Industrial Estate,
Ford Airfield, NR. Arundel,
West Sussex, BN 18 0BD, U.K.

ICE 8.00

This specially-priced
PDF is available
through the ICE
Online Store at
www.ironcrown.com

Universal Night Watch™

Silent Death



Credits

Original System Design: Kevin Barrett

Night Watch Authors: Craig Marek,
Bob Starr, Doug Bertram,
Heike Kubasch

Cover Illustration: Alan Gutierrez

Interior Illustration: Dan Smith

Miniatures Sculptor: Chris Tubb

Series Editor: Donald G. Dennis

Art Direction: Jessica Ney-Grimm

Assisting Art Direction: Jason O. Hawkins

Cover Design: Nick Morawitz

Pagemaking: Steven Arensberg,
Mike Dunbar, Wendy Frazer,
Sherry Robinson

Editorial contributions: Bruce Neidlinger.

ICE Staff:

CEO: Bruce Neidlinger;

President: Pete Fenlon;

Managing Editor: Coleman Charlton;

Sales Manager: Deane Begiebing;

Sales, Customer Service and Operations:
Steve Hardy, Olivia Johnston,
Dave Platnick, Karina Swanberg,
Monica Wilson;

Editing, Production, and Development:

John Curtis, Donald G. Dennis,

Wendy Frazer, Jason Hawkins,

Bob Mohnney, Nick Morawitz,

Jessica Ney-Grimm, Michael Reynolds;

Shipping and Receiving: Dave Morris,
Daniel Williams, Chad McCully.

Copyright © 1997 by
Iron Crown Enterprises.
All rights reserved.
No reproductions without
the express written
consent of **Iron Crown
Enterprises.** Produced
and distributed by **Iron
Crown Enterprises, Inc.,**
P.O. Box 1605,
Charlottesville, VA 22902.
Phone: (804) 295-4280.
Fax: (804) 977-4811.
Internet e-mail:
askice@aol.com
walsfeo@aol.com

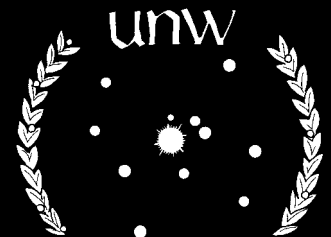

Silent Death

Play-testers:

The Good, The Bad,
and The Unlucky: Paul
Carroll, Chris Kuhn,
Don Jenkins, Alan
Nuss;

Castle Archon: Jim
Eisert, Luke Morgan.

Table of Contents

Introduction	3	Scenario 4: Pay Back!	31
Post War Politics	3	Scenario 5:	
Back into the Past	4	Action over Marathon III	32
The "Universal Night Watch"	5	Scenario 6:	
Swarm 1819	7	Capture the Comm Sat	33
Universal Night Watch		Scenario 7: All or Nothing	34
Organization	8	Scenario 8: New Foes	35
Universal Night Watch		Scenario 9: Gates of Hell	36
Surface Missions	10	Advanced Scenarios	37
Universal Night Watch Politics	11	Scenario 1: Baptism of Command	37
Timeline	12	Scenario 2: End of Command	39
New Equipment	13	Scenario 3: Run for Home	40
Hamerhead Missiles	13	New Terran Starcraft	41
Tachyon Conveyance Weaponry	14	Pyramid's Shipyards "Falcon"	
Electro-Magnetic Pulse Cannon	14	Command Escort	41
Enhanced Filtration System	14	Comet-Coyote Speed Designs	
Copilots	15	X17A "Firebats"	42
Command Ships	15	Mitsuzuki Amalgamation	
The TOC	16	Type 400 "Rattler"	42
Scanner Suite	17	Military Building Systems	
Effects of scans on Ink	17	FX24 "Hornet"	43
Data Links Terminus Torpedoes	18	Military Building Systems	
Effects of scans on		FX34 "Equalizer"	43
DLT Torpedoes	19	Backnet Outfitters GTX	
Optional Rules	20	"Javelin"	44
Night Watch Units	21	Military Building Systems	
House Colos	21	FX41 "Praying Mantis"	44
House Red Star	22	New Grub Starcraft	45
House Tokugawa	22	Hatchling Starcraft	
Yoka-Shan Warworlds	23	Type H-1256b "Muckworm"	45
Kashmere Commonwealth	24	Hatchling Starcraft	
Hibernian Freehold	24	Type H-6382r "Vartak"	45
ASP Technocracy	25	Refit Starcraft	46
Data Sphere	25	Thunder Bird NW	46
Unkulunkulu Archipelago	26	Teal Hawk NW	46
Q'raj Void Protectorate	26	Nighthawk NW	47
Luches Utopia	27	Lance Electra NW	47
Basic Scenarios	28	Salamander NW	47
Scenario 1: The Battle is Joined	28	Epping NW	48
Scenario 2: Anyone Out There?	29	Command Betafortress NW	48
Scenario 3:			
Recovery of Command	30		

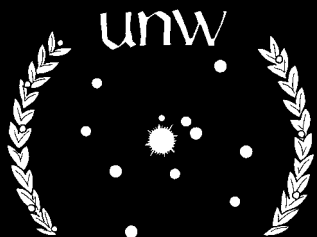

Introduction

In the years that followed the Grub-Terran War humanity had just one thought: survival. War-weary and battered, relations among the Twelve and the lesser powers settled into a precarious peace. Military escalation, suspicion, and mistrust became the order of the day, and all of the Twelve built strong and effective militaries designed to resist outside incursions. The greatest, and most universal fear was that the Grubs would return, and the presence of the alien Draconians and Primates only increased the fears of humanity.

*As time passed and the Grubs seemed to sleep, fear turned to anger, and then to hope. Thoughts of defense turned to offense; men and women dreamed of reclaiming what had been lost to the Grubs. Those powers with some excess resources began a cautious survey of Grub-infested planets. Some of these worlds had become barren rocks riddled with Grub warrens, but others, although still devastated, were less desolate. It became apparent to the surveyors that the level of Grub activity varied from planet to planet. With this revelation came another terrible certainty; there were still survivors on many of the Grub-occupied worlds. The quest to reclaim lost planets suddenly became personal. The time had come for the Terrans to take the war to the Grubs. Only one race would survive. (Excerpt from *The History of the Grub-Terran Conflict*, by T. Gibbon.)*

Post War Politics

The years that followed the destruction of the Terran Empire were full of squabbling as the members of the Twelve struggled for dominance. The activities of House Colos, the Luches Utopia, and the Sigurd Archdiocese were a constant source of friction among the Twelve. House Colos and Luches Utopia concentrated on exploiting and conquering smaller governments, which inevitably aroused the hostility and suspicions of the other houses. Neither the Luches Utopia or House Colos, however, were strong enough or foolish enough to

risk open warfare with other members of the Twelve. The fear of awakening the Grubs kept hostilities to a minimum, and saved many smaller powers from being swallowed by House Colos.

The fanatic Sigurd Archdiocese began to lose allies in the years that followed the war. Many hard pressed planets had originally welcomed the Sigurd's aid in fighting off the Grubs and millions flocked to Gunther Guttman's banner. When the threat of the Grubs abated, however, the religious fervor waned. Apparently, the followers of the Odin were not the only chosen people; other planets, peoples, and faiths had also managed to survive the onslaught of the Grubs. Guttman's fanaticism also began to cost him allies; he was not content to condemn the rest of the Twelve for making alliances and agreements with the Primates and Draconians, but declared that these activities made the other houses the enemies of the Archdiocese. The Sigurd's allies, therefore, were forced to choose between alienating almost every other Terran power in the galaxy and two powerful alien races, or maintaining good relationships with the Sigurd Archdiocese. Many of their allies, therefore, opted to maintain good relations with the Twelve.

The Yoka-Shan Warworld was one of the few planets that continued to thrive after the war. Business boomed for Yoka-Shan. Naturally, the Yoka-Shan pioneered the development of anti-Grub military tactics and forces. The Yoka-Shan forces also had the distinction of being one of the first military forces to rescue survivors on a planet that had been occupied by Grubs for several years. The squadron that performed the rescue, a brother squadron of the famous Yoka-Shan "Sorcerer" squadron, was called the "Night Watch." In honor of the unit, all Grub-busting outfits eventually became called Night Watch units. With the rescue, demand for Yoka-Shan's services soared.

All and sundry hired them for Grub-busting and to train their fledgling Night Watch units to fight Grubs. The demand for Grub-busting services was so wide spread that the

The Next Millennium

Honor Among Thieves

The briefing room lights dimmed as Commander Straun ascended the dais. Behind him, a holographic display flickered into existence.

"Listen up, gentlemen. I hope you're as tired of baby-sitting garbage scows in some backwater system as I am. We've been given a chance to do something useful here. If we pull it off, we may finally get to see some real action. I want this thing to go down by the numbers."

A rumble of assenting grunts came from the assembled pilots.

"The mission profile is pretty straightforward. Lt. Kline, in Claw 9, will make a high speed reconnaissance run above Norril V. Intelligence reports indicate that Grub activity in this system is low. Preliminary scans made since we entered the system confirm this. A single ship should be able to get in and out before the Grubs even know it's there. That's the theory, at least."



Silent Death

Straun turned toward Capt. Starr, the Claw squadron leader.

“Bob, I want you and the rest of your flight suited-up and in your ships in case there’s trouble. If Kline hollers for help, you’ll launch immediately. If that happens, you need to pour it on. At the midpoint of his run, Kline’ll be over forty minutes out from the *Kodiak*. We won’t be able to communicate with him at that point. His ship will have passed behind the planet, into it’s sensor shadow.

“My request to have a group launched and on station, to cut response time, was denied. It seems the-powers-that-be believe the fewer active ships, the less chance of enemy contact.

“Kline, I hope you brought your running shoes.”

Snapped out of his reverie, Kline bolted upright in his seat.

“Yes, sir! Got my rabbit’s foot and fuzzy dice, too, sir.”

Yoka-Shan opened a new military academy specifically to train off-worlders in Grub fighting techniques. Enrollment was open only to “friendly” governments, most of whom were only too happy to pay their cadets’ tuition. The Yoka-Shan had proven not only that the Grubs could be defeated, but that the Terrans could actually survive a prolonged Grub occupation. Soon all of the Twelve were scrambling to build their own Night Watch squadrons.

All of the Twelve eventually developed anti-Grub units, but until the foundation of the Universal Night Watch, few made head way in reclaiming planets from the Grubs. House Colos and House Devon each managed to reclaim their home worlds with the help of their Draconian and Primate allies respectively, but they were notable exceptions. Other powers focused on smaller, more attainable goals: containing the Grubs and rescuing survivors.

The Twelve soon realized that military might would not be the sole means of defeating the Grubs; a more comprehensive approach was necessary. Yoka-Shan, House Tokugawa, House Red Star, and the Data Sphere began an extensive anti-Grub research program. Their goal was to make planets unpalatable to the Grubs. Much of the initial research focused on the Tokugawan planet of Po Yang, which had remained completely untouched by the Grubs

Back into the Past

In the years that preceded the Civil War that eventually lead to the downfall of the empire, a small handful of planets on the distant frontier were waging a vicious, desperate battle against Grub incursions. Not wishing to cause wide spread panic, the emperor decided to keep this little problem a secret, and quietly dispatched several units of Millennia Warriors to clean up the mess. Unlike the empire’s previous contact with the Night Brood, there was no quick victory for the Terrans; the war was still raging when the Civil War swept across the galaxy. Ironically, the detonation of the doomsday device came to frontiersmen’s aid because the Grubs withdrew from the frontier to attack the core worlds.

Having learned a thing or two about the Grubs, locals and Millennia Warriors alike knew that the Grubs would return. Preparations began. Military production and training went into high gear and residents moved as much as they could below the surface of the planets as an additional defensive measure. Anyone who could hold a weapon was trained to fight. Any political differences that they might have had, had already evaporated while fighting the Grubs. Civilians and soldiers assembled and disassembled everything that they had learned about the Grubs. Every success and every failure was carefully scrutinized. With their resources depleted by years of warfare and the knowledge that this time there would be no help from the empire, the frontiersmen knew that the key to their survival lay in unity. The surviving governments formed a political and military alliance called the Confederation of Free Planets. The Millennia Warriors found a new allegiance; during the long years of warfare they had established strong ties with the people of the Confederation. When the emperor sounded the recall, most of the Millennia Warriors chose to remain in the Confederation to fight the Grubs. It was Grubs that the Emperor wanted them to fight, and Grubs they would fight; they merely chose the place of battle. Even if the CFP lost, the Grubs would not find it an easy victory.

The decision to move underground and the extensive preparations reaped major benefits when the Grubs returned. The Confederation withstood the return of the Grubs with minimal losses. Surprised by the Confederation’s fierce resistance, or perhaps sated by their victories on the core worlds, the Grubs faded into the backnet. The people of the Confederation vowed that the Grubs would never return to their territory. The Confederation of Free Planets thrived on the remote frontier as a small but potent force.

The Confederation had created an oasis of peace and stability on the frontier, but outside of their borders dissension thrived. They had enough to do protecting their borders and keeping track of their neighbors. The Draconians had begun to make trouble in their sector.

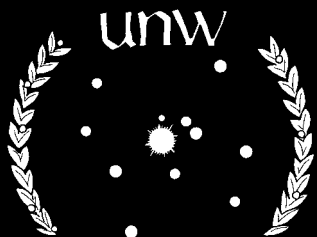



The “Universal Night Watch”

In AL 6, several of the Confederation’s smaller neighbors hired the Yoka-Shan to deal with the Draconian pirates. The Warworlders had just routed the lizards and were mopping up the remaining Draconian units, when it occurred to the Draconians that the appearance of several Grub Swarms, would probably distract the Yoka-Shan forces from the Draconian retreat. The Draconians therefore detonated a nuclear warhead over a Grub-infested planet. Fortunately for the Warworlders, the Confederation had been keeping a close eye on the Draconians, and had suspected them of deliberating provoking the Grubs. Confederation ships assisted the Warworlders during the battle, and the Grubs were routed.

In the days that followed the Yoka-Shan became interested in the Confederation’s multi-planet, universal anti-Grub force. The force was similar to their own Night Watch units, but tapped the resources of

multiple governments rather than merely one or two. The Yoka-Shan were particularly impressed with how the Confederation had managed to carve out a small but completely Grub-free section of space. Yoka-Shan commanders were quick to see the advantage of the Confederation’s multi-government approach to the Grub problem. With the meager military resources of several sparsely populated planets at its disposal, the Confederation Night Watch was many times more efficient against the Grubs than the scattered, disunited efforts of the Twelve.

Although the warriors of Yoka-Shan were experts when it came to dealing with Grubs, they were still impressed by the Confederation’s successes. The Warworlders were also confident that a similar approach could work among the Twelve. Accompanied by Confederation envoys, they returned to Yoka-Shan and presented the idea to their government, which quickly embraced the idea. Yoka-Shan then proposed the creation of a “Universal Night Watch” to the Twelve.

“Didn’t mean to interrupt your nap, son. I just thought you might want to pay attention—it’s your butt on the line here.”

“Yes, sir!”

Kline sat up even straighter in his seat and tried to appear the model of attentiveness. As Straun droned on about callsigns and waypoints, Kline returned to his previous thoughts. Forty minutes was going to be cutting it close, he

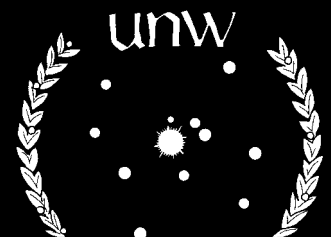

Silent Death

thought. It would take at least twenty minutes to reach the planet's surface, leaving only another twenty minutes to execute his plan.

The briefing ended and all present came to their feet. A few of the other pilots slapped Kline on the back and wished him luck. Kline thought he could see the green glint of jealousy in the eyes of his comrades.

The fastest way to promotion in the Luches Utopia navy was to run up a high kill score. For the past few months, the Black Grizzlies had been assigned to garrison duty in a recently liberated system. There had been little action and even less chance for advancement. Now that CentCom had placed the squadron back on the front lines, all of the pilots were competing for assignments that would result in enemy contact.

Kline could feel the envious stares of his squadron mates on his back as he walked to

The Universal Night Watch would draw not only on the combined military resources of the Twelve, but those from any other planet or government that wished to join the organization. These resources would enable the organization to patrol and protect its members' territories against the Grubs. The Night Watch would also fight Grub Swarms in space and cleanse infested planets. Its scientific branch would extend the battle against the Grubs, developing new weapons and Grub defenses. Finally, the UNW would also act as a training ground for its members military, teaching them the best strategies and tactics against the Grubs, and thus strengthening the overall security of its members. As an additional incentive, the Warworlders announced that their off-world military academy would henceforth be designated as the official training academy of the new Universal Night Watch. Only members of the UNW would be allowed to attend the facility.

The primary stumbling block to the new organization was the settlement of real estate claims; which power would lay claim to newly cleansed planets? House Colos and the Luches Utopia had been particularly aggressive in their claims to other Houses' planets. Sensibly, the new UNW proposed that planets cleansed by the UNW would be returned to their former houses, provided the House could show a valid claim to the planet. Planets that had no claimants would be resettled by refugees and citizens from all members of the UNW and be granted independence.

House Tokugawa, House Red Star, and the Q'raj Protectorate were the first members of the Twelve to join Yoka-Shan in the UNW. The primary contributions of House Red Star and the Tokugawans were scientific; together the two houses established the scientific research wing of the UNW. In addition, Red Star and Tokugawa each contributed squadrons of ships to the UNW. The enigmatic Data Sphere also enrolled

in the UNW simultaneously with House Tokugawa and House Red Star, contributing ships, pilots, scientists, and technology. The Q'raj, angered by the actions of House Colos and the Luches Utopia contributed a substantial force to the UNW. They were particularly anxious to thwart the Colosians' imperialistic ambitions. House Devon, having managed to reclaim their home world with the assistance of their Primate allies, quickly contributed a small but veteran force. The Primates created tremendous good will by sending the UNW a highly experienced squadron of pilots and a battalion of ground troops. In their battles against the Grubs, the Primates too had learned the value of cooperation. Surprisingly, contributions to the UNW of ships, personnel, and equipment poured in from the smaller planets. Some of the poorer planets were only able to contribute

a few ships. Many of the pilots who enlisted in the UNW had lost their home worlds to the Grubs.

Superb teachers, the Warworlders and the CFP officers trained and retrained the new UNW recruits, enrolling most of them in their UNW training academy. Military strategists incorporated the new knowledge

from the CFP and accounts of tens of thousands of battles and skirmishes to improve their anti-Grub tactics. In a daring move, Yoka-Shan commanders began mixing and recombining the units from the different planets to create the first "Universal Night Watch" units, a cadre of sentient beings dedicated to exterminating the Grubs.

In a savvy political move, the new UNW took the war to the Grubs and began a successful assault of a moderately-infested former Tokugawan world. It was a stunning demonstration of what a "Universal" Night Watch could do. The Tokugawans then invited refugees who had lost their home worlds to the Grubs to resettle the cleansed planet. This move bolstered the popularity of the UNW, and many citizens demanding outright that their planetary governments join the UNW.

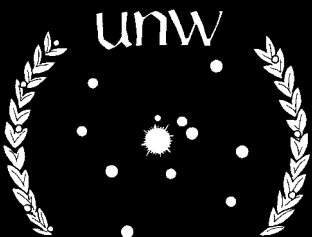
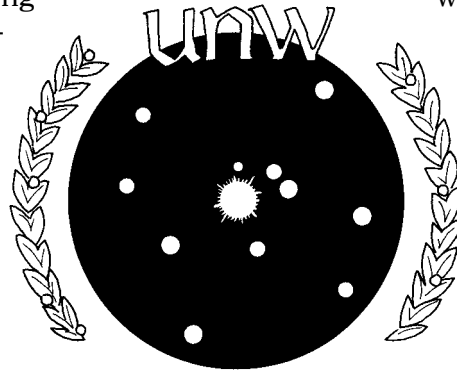

Bowing to increasing political pressure, most of the Twelve relented and joined the UNW. In general, the majority of the contributions are military; the Hibernian Freehold is the main exception, and has organized the intelligence and information gathering branch of the UNW. House Colos fought for a variety of concessions before finally consenting to join the Universal Night Watch. The only concession that they managed to win however, was that the new UNW headquarters would be located in orbit around Yoka-Shan Warworld. The opportunity to train near Yoka-Shan and steal Yoka-Shan technology has proved irresistible to the Colosians. To maintain a plausible facade, the Colosians have contributed a respectable force to the UNW while continuing to maintain their own larger independent NW units. Of the Twelve, only the Sigurd Archdiocese remains aloof and has refused to join the UNW. The Sunrunners have lobbied for admission into the UNW, but have been rejected.

The Luches Utopia has been the last to join, grudgingly contributing a force to the UNW. The Luches government was reluctant to expose their repressed lower class or their corrupt upper class to the relative luxury and discipline of the UNW. The Utopia was also unwilling to allow UNW listening platforms to be placed in Luches territory. With the arrival of Swarm 1819, that changed.

Swarm 1819

Swarm 1819, "Morass of Evil" was one of the most virulent and aggressive swarms encountered since the fall of the Empire. It was far more than the Luches Utopia forces could cope with. Although UNW listening posts detected the disturbance, the UNW did not intervene, but did place their forces on alert in case the conflict awoke other swarms. Fortunately, only one other swarm (1820 "Ambush Bugs") was disturbed. Luches forces fleeing Swarm 1819 flew directly into the path of Swarm 1820.

President Marley offered the Utopia assistance, but only on the condition that the Luches join the UNW. The offer also included information on a half a dozen other swarms that could be awakened if the conflict was not resolved quickly and efficiently. The offer implied that the UNW might just be willing to allow Luches space to be ravaged by Grubs, and then the UNW would contain the swarms when they were once more dormant. With basically no choice, the Luches Utopia agreed to all of Marley's terms, and UNW forces intervened and defeated the Grubs. Unfortunately, very few members of the Luches strike force survived to enjoy the victory.

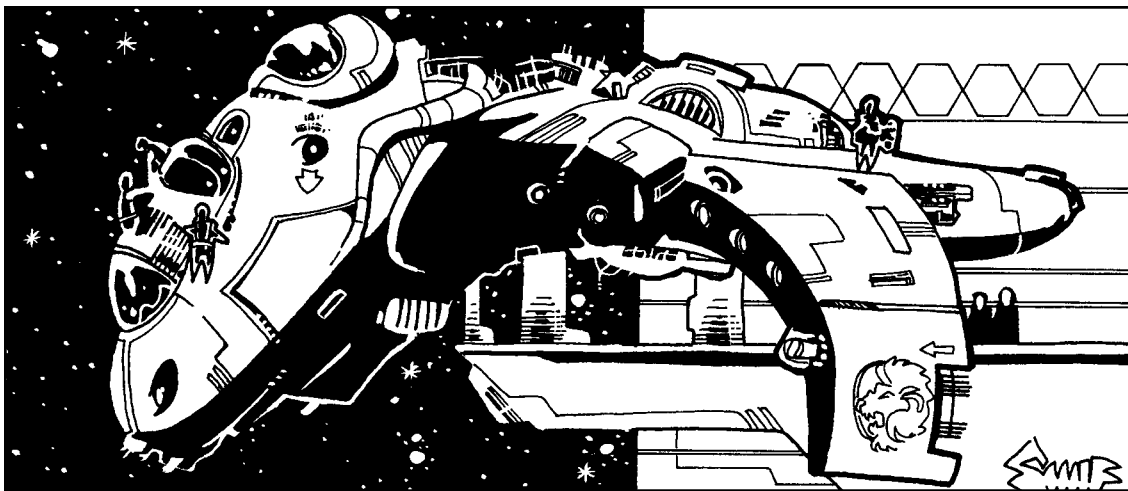

The Next Millennium

the lift that would take him to his fighter. Next time you save the squadron leader's butt, you'll get the plum assignment, he thought. Besides, there are much easier ways to get a promotion.

The lift deposited Kline in the hangar, where he was greeted by his crew chief, Millard Gratton. Gratton was a short, stocky man with close-cropped gray hair. Kline thought him a bit dull-witted, but the man knew his way around a fighter.

Kline's ship was always in top-notch condition.

"She ready to fly, chief?" asked Kline.

"Ready as ever," responded Gratton with a knowing wink.

Kline groaned inwardly at Gratton's touch of melodrama and began his pre-flight inspection. All appeared in order. Kline clambered up the steps and settled into the cockpit of his Thunderbird NW. Green lights across the board.



Silent Death

"Mama Bear, this is Claw 9, ready for launch, over."

"Roger that Claw 9. Launch when ready."

The flight deck opened above the fighter and sunlight spilled into the hangar bay. The T-Bird shuddered slightly as the elevator began to rise. Once the cockpit cleared the level of the flight deck, Kline could see Norvill V ahead of him. At this distance it was a small orb, no larger than a silver dollar.

The elevator banged to a stop. The fighter shook again as the docking clamps fell away. Kline rammed the throttles against the stops and the Thunderbird leapt from the Aosho class carrier's deck.

Kline engaged the auto pilot and leaned back in his seat. It would be another thirty minutes before he was close enough to the planet to activate the two recon pods. With nothing else to occupy his mind, his thoughts turned back to the scheme upon

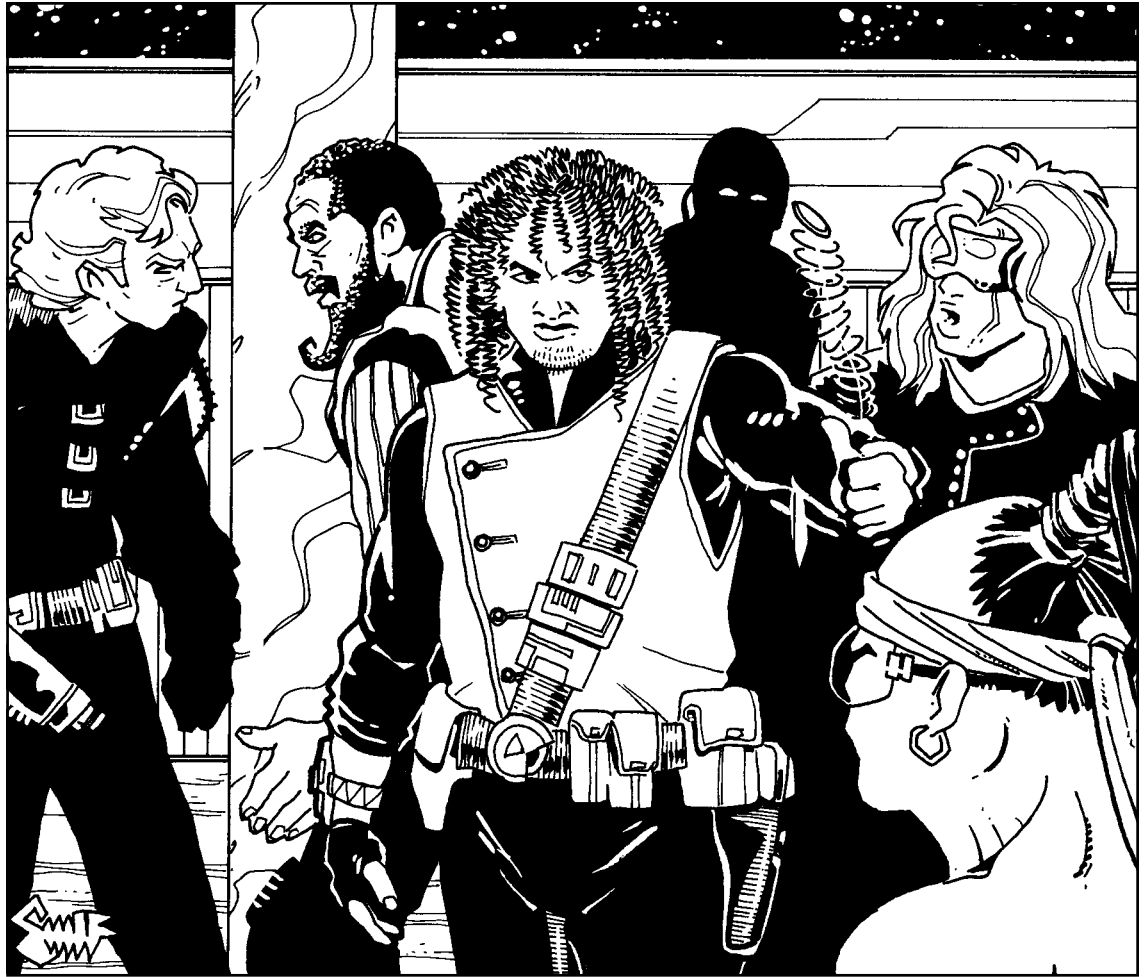

Universal Night Watch Organization

The UNW contains over fifty members. Each government holds one seat on the UNW council. It is the council which makes all major UNW decisions, including choosing planets which will be liberated from the Grubs. The leader of the council is Marcus Marley, the retired president of the Unkulunkulu Archipelago. Marley was selected not only for his political neutrality, but because none of the UNW members view the Archipelago as a threat, as the Archipelago alone seems to have no political agenda. The council leader has the tie breaking vote. The headquarters of the UNW are in orbit around Yoka-Shan, considered by many to be the safest place in the galaxy.

Although the primary purpose of the UNW is to fight Grubs, it has begun to develop into an informal alliance. Member governments are expected to keep hostilities among themselves to a minimum, the reasoning being that since violence awakens the Grubs, inter-member warfare would defeat the pur-

pose of the UNW. The prominent participation of Yoka-Shan has tended to foster more peaceful relations among members.

New members are admitted to the UNW with a simple majority vote. Prospective members are carefully scrutinized before admission; they must demonstrate that they are an independent political entity and not merely a political extension of another government. Participants are required to make contributions of either equipment or personnel to the UNW. The emphasis is upon the quality, rather than upon the size of the contribution. All UNW members must also contribute funds to cover the UNW's substantial operating costs.

The heart of the UNW is its Central Command. While the council makes the larger decisions, the Central Command runs the UNW. The CentCom, for example, will present the council with a list of potential planets to cleanse, and once the council makes the decision which planet to target,

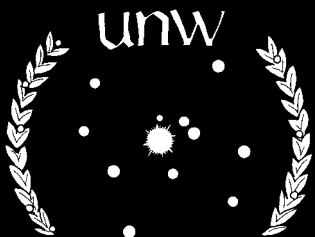

the CentCom will plan and execute the operation, briefing the council as progress is made. The council generally does not intervene in CentCom military operations once they have been cleared. The CentCom is also free to authorize rapid, emergency military operations without the consent of the council. This flexibility has allowed for quick responses to Grub incursions. The command is staffed by hand picked, highly experienced military and intelligence officers, scientists, and administrators. It coordinates and directs the activities of the military, scientific, and research branches of the UNW. The CentCom is also responsible for administration, logistics, supply, and acquisitions and maintains a standing pool of resources which it distributes to the various branches as it sees fit. It is also responsible for the over all planning of military operations and training.

The combined efforts of the military, scientific, and intelligence branches of the UNW give it its strength. These are staffed by the best that the UNW has to offer. All UNW military personnel train at UNW military on Yoka-Shan. Scientists and technicians from all of known space work in the UNW research facilities, and the Hibernians have recruited and unusual assortment of personnel to work for the intelligence branch.

The UNW's military force is its most dominant branch. The military contains air and ground personal and is among the best-equipped forces in the galaxy. The star fleet has ships ranging from small single-person star ships to escort-sized cruisers. The ground troops are considered the most dedicated and feared of the UNW military, since they have no qualms about confronting the Grubs on their home turf. The UNW has also trained an elite commando unit, which specializes in infiltrating infested planets. There is a fierce rivalry between these "grunts" and the "Grub-busting" starcraft pilots, since the grunts are convinced that they do all of the real work.

UNW military operations are varied. The most common is patrol duty. Units fly routine patrols in UNW "hot zones;" areas of UNW space which show indications of increased Grub activity. Squadrons are rotated across UNW space every six months. Reconnaissance missions over target plan-

ets are also a vital part of UNW operations. The two most dangerous missions for fighter squadrons are head to head confrontations with Grub Swarms and providing covering fire for ground troops. The largest, and most dangerous, but also the most rewarding of all UNW operations are planetary assaults, which can require months of preparation. The members of the UNW's scientific branch are equally dedicated. Scientific research has continued along the multi-approach path pioneered by Houses Tokugawa and Red Star and the Data Sphere. Scientists are focusing their efforts not only on building better weapons and ships, but also on Grub xenobiology. The scientific division is also experimenting with the development of robotic probes which will one day actually land on Clutch Worlds to gather information. Fortunately, Night Watch pilots and ground troops have been providing plenty of raw material for research, including the capture of Builders and a much-feared Blood Worm. The Grunts in particular pride themselves in bringing back "souvenirs" from their missions.

Working with the alien Moldates, scientists have tentatively begun to understand Grub communication. In conjunction with the military, they have begun to experiment with the placement of Moldates on TOC ships during missions. Currently, the Moldates seem to be the only sentient race who can not only sense Grub activity at distances of many light years, but also to some limited degree understand the Grubs. UNW commanders hope that by working with the Moldates, Night Watch combat personnel will eventually receive advanced information about Grub tactics during combat. (For information on the Moldates, see *Silent Death: the Next Millennium* sidebar text pp. 85-98.)

The most important area of research is that of anti-Grub defenses. The highest priority has been the design and production of sophisticated Grub activity detection equipment. The mass of research has paid off, and the scientists have for the first time been able to develop reliable Grub early warning systems. These warning systems are modified escort class ships staffed by humans, Moldates, robots, and a smattering of alien species. All of UNW space is

The Next Millennium

which he was embarking. To be sure that he had not overlooked anything, he ran down his mental check list a few times. Satisfied that he had covered all the bases, Kline silently prayed that Gratton had been able to hold up his end of the deal.

Now, if the Grubs cooperate, he thought, I'm on my way to being Group Captain within a year. If not, I'm in some serious trouble. Gratton's modifications have disabled my lasers and the recon pods have replaced two of my four torpedoes. That leaves me with only two torps and ten missiles to throw at any Grubs that get in my way.

The insistent beeping of the nav computer interrupted Kline's train of thought. Norvill V was much closer, filling most of his forward view. Time to begin his run. He reached out and punched the button activating the recon pods. Beneath the Thunderbird's wings sensors sprang to life and began to

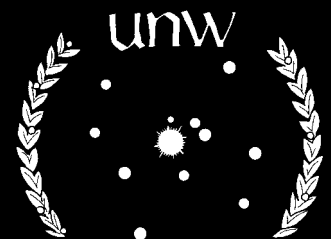

Silent Death

scrutinize the surface of the planet below for signs of Hatchling activity. The data they generated was instantly sent back to the *Kodiak* via tight-beam transmission.

“Claw 9 to Mama Bear. Pods are hot, commencing run.”

“Roger, Claw 9. We’re picking up your feed. Mama Bear out.”

The Thunderbird veered slightly as the autopilot adjusted course to place it in a fast slingshot orbit around the planet. Hell, thought Kline, I’m just a passenger. As long as there’s no enemy action, the autopilot can fly this mission.

Kline kept one eye on the nav computer as his ship began to accelerate under the force of Norvill V’s gravity. Once it showed there was less than five minutes before he passed behind the planet and lost communication with the carrier, he reached out and punched a short code into the ship’s diagnostic console. A wailing din filled the

becoming saturated with Grub detection platforms, which has tremendously reduced the UNW’s response time to Grub crises. The UNW has also begun to place these platforms around clutch worlds to monitor Grub activity. Another vital area of research has focused on making planets more defensible and unpalatable to the Grubs.

The UNW intelligence branch is primarily responsible for collecting and analyzing hard data on Grub activities. Most UNW Grub detection platforms are staffed by UNW intelligence personnel. Together with the military and scientific branches, intelligence tracks the movement of Grub swarms across space. Their most difficult job is determining the Grub population on infested planets and the possibility of Terran survivors. The UNW selects prospective planets for cleansing based on their intelligence reports and their risk assessment. A mistake could cost thousands of lives. To date the UNW has been fortunate; the intelligence branch has never made the error of underestimating the Grubs.



Universal Night Watch Surface Missions

The Universal Night Watch ground assault troops have only one motto: “Bring ‘em back alive!” Success is measured not by the number of planets cleansed, but by the number of survivors that are rescued from infested worlds. In practical terms, it requires a tremendous amount of resources to cleanse a Grub-infested world; the UNW and the Twelve do not currently have the resources to cleanse large numbers of Grub-infested planets. Therefore, UNW planetary assaults fall into two categories; the smaller rescue operations and the “planet-liberation” assaults. The UNW has discovered that the survivors can provide valuable insights into Grub activity; insights that can eventually contribute to the liberation of the planet.

The first step in a rescue operation is to determine the presence of survivors on a planet. Those who survived on Grub-infested worlds quickly learned that not only aggression, but the use of high tech can be detected by the Grubs. The Grubs seem particularly adept at detecting radio communication, making radioing for help a very bad idea, since it alerts the Grubs to the Terrans’ presence. This radio silence explains why many worlds that appeared dead in reality have survivors. The UNW uses its Grub-monitoring platforms to search for human activity on Grub-infested worlds. UNW intelligence then works feverishly to gain as much information about the target world as possible before the rescue operation begins. On worlds with moderate infestations, survivors are contacted by the UNW commando teams and then stealthily lifted off the planets on shuttles. These operations can take many months to avoid arousing the Grubs. On more lightly infested worlds, the UNW uses larger ground units and emphasizes speed over stealth.

Only planets with light to moderate Grub infestations are targeted for planetary liberation. The UNW intelligence branch is responsible for determining the infestation level of a target planet. Such a survey can often take months. Then, once the council

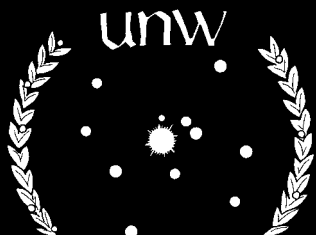

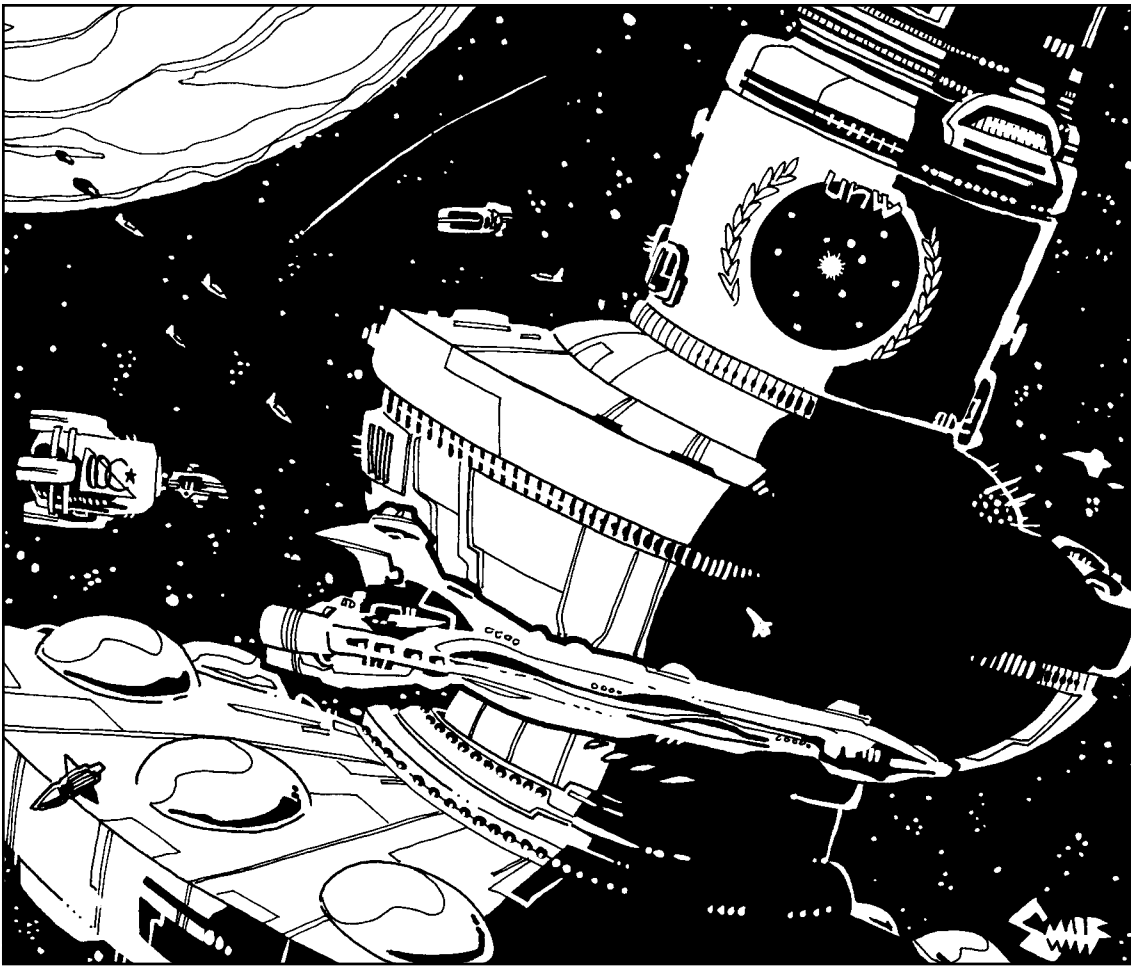

has selected a target, military preparations begin. These too can take months of planning. A major deciding tactical factor is the speed. For the operation to succeed, the planet must be liberated quickly. Every day that the assault continues increases the chances that near by Grub Swarms will awaken and come to the aid of their brethren. Since its foundation, the UNW has been able to liberate approximately one planet a year.

Universal Night Watch Politics

UNW politics have been rocky since its inception. The greatest source of conflict is the question of which planets should be cleansed by the Grubs. The UNW has designed a thorough and careful decision making process, which has begun to reduce political friction. The choice of which planets will be liberated is and painstaking. Although this has made refugees impatient, it keeps the UNW from being accused of playing favorites.

Another recurring problem for the UNW has been the political machinations of House Colos, the Luches Utopia, and the Draconians. All three powers have repeatedly tried to have puppet states admitted to the UNW in an attempt to gain control of the organization. Although they have had occasional successes, members of the UNW have been generally successful in thwarting their political power plays. The three powers are also hindered by their tremendous unpopularity. UNW intelligence, supported by the Hibernian Intelligence Agency, also has a knack for uncovering bribes and other unsavory activities. The Draconians have also been forced to tread carefully, since irritating a single members of the UNW could arouse the wrath of several powers. Open intervention might also cost them existing allies.

The Next Millennium

cockpit as multiple alarm systems sounded at once.

Show time, thought Kline.

“Claw 9 to Mama Bear, I’ve got some anomalous readings from my power plant, looks like my containment field is destabilizing.”

“Roger, Claw 9, do you need assistance?”

“Wait one, over.”

His eyes locked on the mission timer, Kline impatiently drummed his fingers and waited for a minute to pass.

“Claw 9 to Mama Bear, the spikes are getting worse. I think the field may collapse. I’m gonna have to shut it down and try a restart.”

“Roger, keep us advised.”

Kline flipped the safety cover off the power plant kill button, then hesitated. Once he cut the power, there was the very real possibility that he may be unable to restart the fusion reactor. The fusion reactors used to power spacecraft

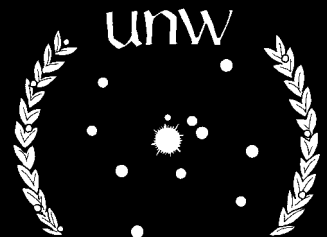

Silent Death

required a large amount of power to fire up. A portion of the power was used to initiate the fusion reaction. The remainder was used to establish the containment field which prevented the fusion reaction from expanding and consuming the ship. In the early seconds of the start-up process, the containment field often became unstable. Automatic safety devices immediately shut the reactor down if this occurred

Once a reactor was started, and the containment field stabilized, its hydrogen fuel supply was sufficient to run for decades. Reactors were normally only shut down for periodic maintenance or if battle damage caused the containment field to fluctuate. In the latter case, if it were determined that it was only a temporary fluctuation, the reactor could be restarted. All ships were equipped with extremely high voltage storage capacitors for this purpose. Most

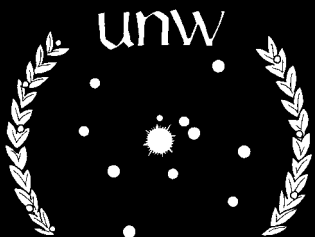

Timeline

The following is a rough timeline featuring some of the most important events that have happened since the fall of the Empire.

Imp 476—Night Brood first contact the Terrans in the Tau Albitron sector.

Imp 477—The 17th Imperial Expeditionary Fleet puts an end to the first Grub invasion.

Imp 496—Millennia Warriors dispatched to the distant frontier to deal with Hatchling probing attacks.

Imp 498—Provincial Powers Alliance leads an attack against the Band of Iron. The Imperial Civil War begins.

Imp 500—The Terran-Hatchling War begins in earnest.

Imp 504—The Civil War officially comes to an end as the Hatchling threat grows.

Imp 507—The Night Brood transport appears over Mars and is obliterated. The Confederation of Free Planets is formed.

Imp 508—The Night Brood returns to Sol. The Imperial core is invaded. The CFP begins the move underground.

Imp 510—Armageddon. Old Earth falls to the Grubs. Emperor Modestinus III's escape ship is destroyed.

0 AL—A new calendar is begun in what would have been Imp 511. The Night Brood are finally stalemated. The Terran-Hatchling War comes to an end.

2 AL—Yoka-Shan Warworld founds its off-world anti-Grub military academy.

3 AL—Yoka-Shan, Tokugawa, Red Star, and the Data Sphere begin a joint anti-Grub research program.

4 AL—House Devon returns to Terran space with the Primates close behind. The Twelve begin to

found individual Night Watch Units.

5 AL—House Colos brings the Draconians into Terran space.

6 AL—House Yoka-Shan and the Confederation join forces to defeat several Grub Swarms.

7 AL—The Universal Night Watch is founded. Yoka-Shan War World, House Tokugawa, House Red Star, the Data Sphere, and the Q'raj Void Protectorate are the earliest members. Thunderbird NW and Teal Hawk NW refits are completed.

8 AL—House Colos and the Hibernian Freehold join the UNW. The Sigurd Archdiocese declines to join the UNW. The UNW headquarters are officially located in orbit around Yoka-Shan. The Draconians detonate an atomic warhead on the moon of a Brood infested planet just outside CFP space. The Epping NW and Salamander NW refits are completed.

9 AL—Ex-president Marley of the Unkulunkulu Archipelago is elected Head of the Council. The Unkulunkulu Archipelago and the ASP Technocracy join the UNW. UNW forces cleanse a Tokugawan world. The Sunrunners apply to join the UNW and are rejected. The UNW acquires EMP technology. Command Betafortress refit completed.

10 AL—Luches Utopia pressured into joining. UNW forces cleanse a Red Star world to be used for UNW scientific anti-Grub research. House Colos steps up its non-UNW anti-Brood activities. Night Hawk NW and Lance Electra NW refits completed.

11 AL—The present.

New Equipment

"The worse the man, the better the soldier."
— Napoleon Bonaparte,
PreImp 1817

"A pilot is only as good as the maintenance crew that keeps the starcraft flying"
—Ssgt. William Smites,
AL 9

Analyses of the Grub-Terran war and a myriad of other Grub-Terran encounters demonstrated that strategies, tactics, and weapons that worked well against Terran units were often disastrous when employed against the Grubs. In order to hold their own, Night Watch units across the galaxy quickly developed new tactics and weapons to combat the Grubs. With the foundation of the Universal Night Watch on Yoka-Shan, the tactics, ships, and weapons of Grub-busting were refined, and are still continually being improved.

Here are all of the new weapon systems and other equipment introduced in Universal Night Watch. Through trial and error, as well as combat experience, weapon developers for the Night Watch focused on negating some of the unique characteristics found on Grub ships. Two things were clear: the Grubs had longer range weapons in great abundance that could hit any Terran starcraft, and the Grub ships had the ability to shake torpedoes and confuse Terran pilots with Ink and Jump Pods. The Grubs had a firepower advantage over

Terran starcraft. Increased range and better targeting systems were needed in order to effectively engage the Grubs at the same range as the Grubs could engage the Terrans. High in the minds of the crews was survivability. Escape pods were good if you lived to use them. Although every crew is afraid of destruction, what they most fear is the dreaded Spore Mole. Equipment designers kept these ideas in mind when they developed the systems for the Night Watch.

Hammerhead Missiles

Historically, missiles were one of the most effective weapon systems employed by the Terrans. After a short analysis of the results of several Grub-Terran battles, weapon manufacturers developed the Hammerhead Missile. The Hammerhead missile has a longer lock-on range than standard missiles. The maximum range for a lock-on attempt with a Hammerhead Missile is 15 hexes due to an improved launch control firing system. However lock-on is more difficult at extended ranges and Hammerheads suffer a -2 penalty to lock on for each added hex of range beyond 11. Hammerhead missiles are treated in all other ways like normal missiles. They are fired in volleys of 5 or 10. During the Missile Results Phase, each missile fired at the target from

a single missile launcher adds 1D6 to the Attack Dice rolled. This means that each attack will roll either 5D6 or 10D6. When resolving damage, use the damage rules, and add +5 to damage for a volley of 5 missiles and +10 to damage for a volley of 10 missiles.

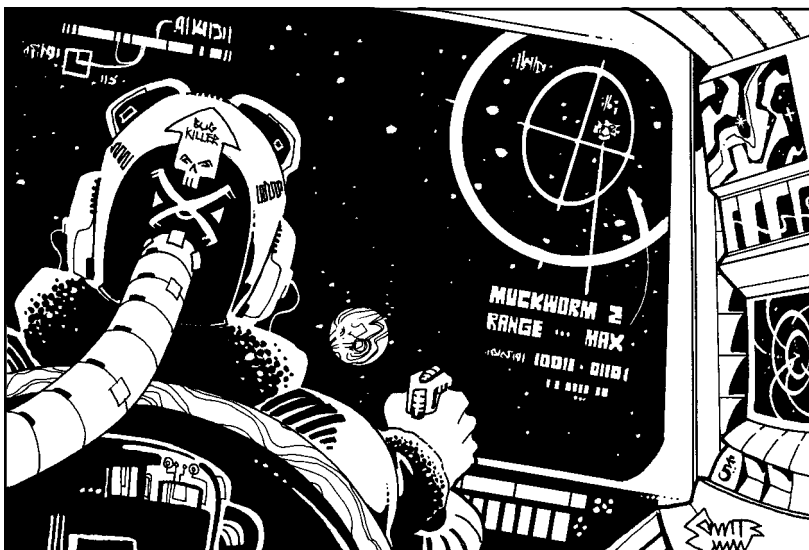

The Next Millennium

fighters were equipped with two capacitors. Each one held enough energy for one restart attempt. If, after two attempts, the containment field had not stabilized, the fighter would be without power until it could be recovered and restarted using another ship's power plant.

No time for cold feet now, he told himself, you've already come to far. His finger stabbed the button and the interior of the cockpit dimmed as the fusion reactor went off-line and the emergency power cells cut in.

"Claw 9 to Mama Bear, I've powered down. Negative on the restart. Repeat, negative on the restart. The power system is non-responsive."

"Roger that Claw 9. How's your trajectory situation?"

"My velocity's slowing, orbit's starting to decay. If I don't restore power in a few minutes, I'm going to have to set down on the planet."

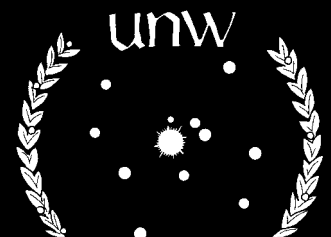

Silent Death

“Roger. Baby Bears are scrambling. Hang in there.”

Damn, thought Kline, the concern is touching, but couldn't they have waited a little longer?

“Roger Mama Bear, still no joy on the restart. I'm shutting down the recon package to conserve power.”

And so it doesn't record what I'm about to do, Kline thought. He glanced at the nav computer. There was less than a minute before he entered the planet's sensor shadow and all communications were blocked.

He checked the other instruments. The Thunderbird was at the closest point of its trajectory around Norvill V; it was actually skimming the extreme reaches of the planet's atmosphere. The resulting drag was slowing the ship and causing it to lose altitude.

Kline waited, his eyes glued to the instruments. The fighter's descent rate was accelerating. The thicker atmosphere buffeted

Tachyon Conveyance Weaponry

The Tachyon Conveyance Weaponry is the newest addition to the Terran arsenal in the war against the Hatchlings. The Terrans were often decimated by the long ranges and the tremendous damage that the Grub Beam weapons inflict. Tachyons are still in use as part of the post Armageddon communications network, allowing instantaneous long range transmissions. Even before the arrival of the Brood, the ASP Technocracy attempted to convert this technology into a weapon of war. Once a low powered laser carrier was developed for the excited tachyons, the results were very promising. Tachyon Conveyance Weaponry was very easy to aim, had excellent range, and was capable of tremendous damage. Initial field tests, however, were less than acceptable. While the Tachyon Cannons were capable of doing tremendous damage to most things, the armor and screening of 99% of all active Terran fighters completely negated the Tachyon Cannon effects. The Tachyon Conveyance Weaponry project was canceled.

At the advent of the Hatchlings, Tachyon Cannons were still considered useless, and were not used during the First Contact wars. With the development of the UNW the ASP Technocracy submitted several technological research portfolios. Most of these were far from completion or considered too dangerous to put into effect. The Tachyon Cannons were another story. While the Tachyon Cannons were ineffective against Terran ships, they turned out to be ideal weapons against the Grubs.

Electro-Magnetic Pulse Cannon

When the Sunrunners applied for admission to the UNW they offered the EMP technology to the CC as a token gesture. CentCom was so impressed with the technology, they employed it immediately in a new Night Watch starcraft, the Rattler.

However, the Council members were not convinced that the Sunrunners or their technology should be allowed in the Night Watch. Without a majority consent of the Council, CentCom has delayed implementation of the EMP technology in additional Night Watch starcraft as well as official recognition of the Sunrunners.

While EMP weapons do only half damage against Terran ships, they do full damage against the Brood.

Enhanced Filtration System

Although the crew of Terran starcraft are sealed in a compressed, environmentally controlled life pod during combat, one Grub weapon manages to overcome the artificial environment. Spore Moles kill the crew in a very painful way, while leaving the starcraft intact. The armor that most refitted starcraft have provides some defense against Spore Moles, but many Night Watch starcraft do not have the additional armor. The lack of armor was considered a design feature, not a flaw. After field reports of the success of the Spore Moles against the non-armored Night Watch starcraft, the UNW engineers were asked by Central Command to find a solution that could be implemented cheaply and quickly. The result of the feverish research was the EFS or Enhanced Filtration System.

The EFS is attached to the starcraft inside each life pod. Powered by the central power grid of the starcraft a backup battery provides protection for a short period of time in the advent of a power failure. The EFS provides additional filtration of the spores contained within the Spore Moles, and contains them in a neutralizing gel. This additional filtration results in a reduction in the effects of the Spore Moles. When a starcraft without Damage Reduction but equipped with an EFS is hit by Spore Moles, the EFS absorbs the number of hits equal to its Type. So if a Spore Mole attack indicates 2 crew are killed, and the starcraft is equipped with a Type 2 EFS, the EFS effectively absorbed the offending spores.

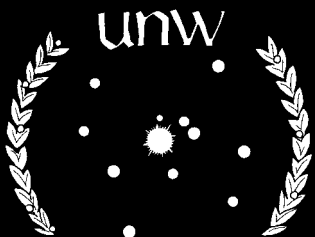



The size of the EFS unit is relatively small and its capability is indicated by a unique type code:

Type 1 Effective Damage Reduction versus Spore Moles +1

Type 2 Effective Damage Reduction versus Spore Moles +2

Type 3 Effective Damage Reduction versus Spore Moles +3

Although a Type 4 EFS exists on paper, it has not been implemented in any Night Watch starcraft due to cost and questionable reliability. Additionally, a starcraft with an EFS unit can either benefit from damage reduction as provided by the armor, or by the EFS unit, not both.

Copilots

Some Night Watch starcraft are not crewed in the traditional method. Rather than a pilot and an assortment of Gunners, a pilot and copilot make up the crew. Along with the crew changes, all piloting systems are crossed-wired for dual controls. This

provides increased survivability for Night Watch crews and ships. Some weapons are listed as having more than a forward firing arc such as the Twin Splatterguns on the Equalizer. These weapons are designated to the copilot and if the copilot becomes the pilot he may only use weapons normally available to the pilot.

Command Ships

Ink Clouds generally cause Terran gunnery to miss when a shot passes through the cloud. The clouds scramble the targeting systems on Terran Ships. The Grub ships, of course, are unaffected. Torpedoes passing through ink clouds also often lose track of their target and become useless. To fight back, the Terran commanders have introduced a new type of starcraft into the Night Watch organizations: the Command Ship.

Currently, the Night Watch deploys two classes of Command Ships. The smallest, the Command Betafortress, is a sophisticated refit of the Betafortress. The larger is an Escort class starcraft. Command ships have two unique features invaluable to Night Watch operations, a Tactical Operations Center, or TOC, and a sophisticated Scanning suite.

Historically, Escorts proved successful during the first Grub-Terran War. In particular, the Fletcher Class Destroyers armed with 4 quintuple Pulse Laser mounts, a twin Ion Cannon mount, 80 missiles, and 30 torpedoes, were very effective against the Grubs. In addition to this spectacular fire power, these ships also had a Tactical Operations Center, TOC, and a sophisticated ECM array. Unfortunately, Emperor Modestinus III enacted Operation Crusader (a.k.a. Operation Bughunt) which put Escorts out of action for the remainder of the war.

Although the Escorts can carry a large volume of weapons, Escorts used for Grub-busting are usually armed with standard fighter weapons. This is due to the severe speed restrictions that the larger Escort weapon mounts suffer. The most significant benefit that Grub Busters receive from the Escort Command Ship is not the mass of fire power, but the Tactical Operation Center and Scanners.

The Next Millennium

the ship and heated it's skin red hot. The view from the cockpit was tinged by a rosy red haze.

Once the instruments indicated that the fighter was well inside the planet's sensor shadow, Kline quickly tapped his authorization code into the console and threw the power plant ignition switch. The containment field around the fusion reactor flared and then stabilized. The power level indicators rose steadily.

"All right," he muttered, "Let's find the landing zone and get this thing on the ground."

Kline flipped on the Doppler imaging radar. A detailed image of the terrain below him appeared in his right multi-function display. He punched in the coordinates given him by Gratton. The display shifted and centered on a city just visible on the horizon.

"Bingo."

Kline altered course slightly and maintained the Thunderbird in a

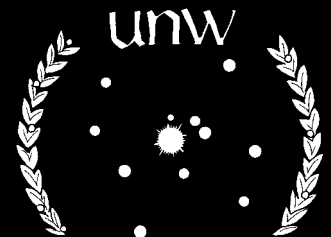

Silent Death

steep dive. The city ahead of him was barely visible through the heat waves emanating off the fighter's skin.

The detail of the display increased as the ship descended and Kline was soon able to pick out individual buildings. With a few keystrokes, he superimposed a map of the city he had obtained from the carrier's database over the radar display. It took only a few seconds to locate the street he was looking for.

Kline altered course again to line up with street and fired a long burst from the forward thrusters to slow the fighter's precipitous descent. The craft slowed to a more reasonable speed and Kline lowered the landing gear. A few final course adjustments, and the fighter was lined up perfectly with its intended destination. Buildings began to flash past the cockpit.

Kline fired the forward and bottom thrusters hard and the fighter slowed, stopped,

The TOC

A TOC contains sophisticated sensor arrays, communications gear, and powerful computers that are used to predict what the enemy will do next. When combined with Scanners, TOC sensor arrays on the Command ships can reduce some of the scrambling affect of Ink Clouds and the activation of Jump Pods. Scanners track Grub movement when a Jump Pod is used or when a Grub enters an Ink Cloud. This information is fed to friendly Night Watch ships and torpedoes. Torpedoes that receive this information have a better chance of maintaining a lock on a Grub ship when it uses a Jump Pod. This gives Terran gunners and torpedoes a better chance of hitting their targets. This benefit is obtained through a data link made possible by the NW electronics package that has replaced the torpedo jamming package in .

The sophisticated electronics suite found on board a Night Watch Command ship links TOC to other UNW starcraft via a data link. The data link provides the receiving starcraft with additional data about the current combat situation. This data includes the projected entry and exit point of a Grub ship using a Jump Pod and a better look into and through an Ink Cloud. Night Watch starcraft are equipped with a special receivers that are tuned to UNW Command ships. Only ships built for Night Watch units by the Central Command or those starcraft es-

pecially modified for Grub-busting as designated by the "NW" suffix, and DLT Torpedoes (See *Data Link Terminus Torpedoes*) can benefit from a data link. When the Command ship tracks a Grub ship, the data is passed electronically to the Night Watch starcraft in the area. All ships and torpedoes that are within 30 hexes (inclusive) are within the data link range. If a ship or torpedo moves beyond the 30 hex maximum range, the data link is automatically lost. No ship may benefit from more than one Command ship at a time.

The TOC rating on a ship determines the effect it has when used in conjunction with a Scanner. Any level of TOC, when used in conjunction with a successful scan, gives a modifier based on the level of the TOC. TOC negates one point of obfuscation due to ink per +1.

- TOCs give +1 to initiative per point of TOC bonus. (See *Warhounds*.)
- In conjunction with a scan, TOCs negate one point of obfuscation due to ink per point of TOC bonus with a successful scan.
- The TOC bonus does not modify the damage delivered for any weapon system or warhead.
- The TOC bonus does not modify the speed or the pilot skill of the torpedo.
- TOC only provides scan benefits to ships with datalink capabilities. All ships with NW designation have DL capabilities.

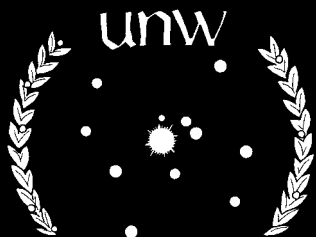
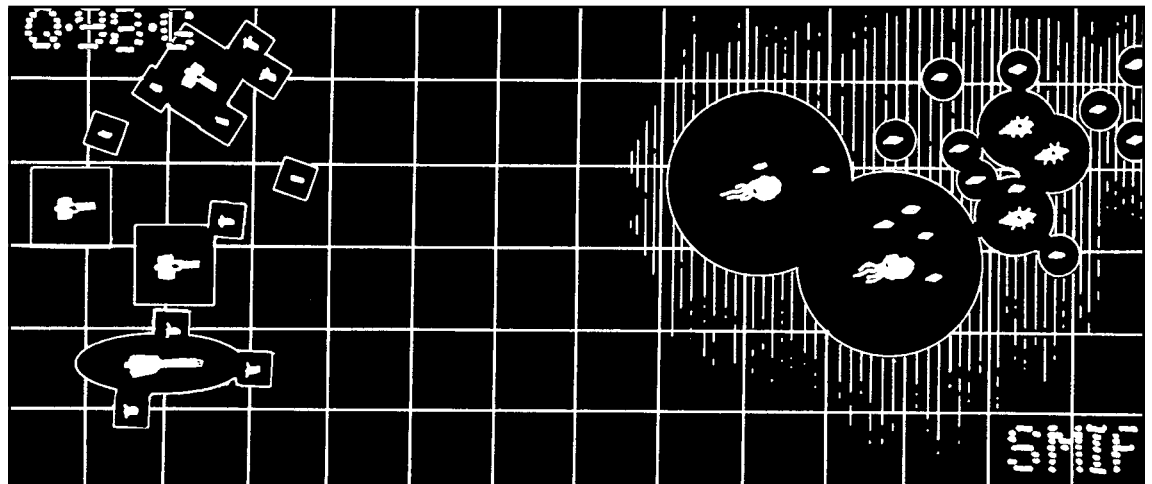

Scanner Suite

The TOC has increased capabilities when linked with a scanner suite. Scanners may lock on to Hatchling vessels or scan the interior of ink clouds.

On the starcraft Display of Command ships, there is a notation that looks something like:

Scanner: 1-7(5)

The number in parenthesis (in this example, 5) is the total number of scanning attempts that the Command ship can make each turn. This number can never be exceeded on any given turn. Each turn, scanning must be established. The range of numbers (in this example, 1-7) represent the chance of success on 1D10. If an attempt is made to scan from within an ink cloud, the success spread is reduced by 4. During the Screening/Scanning phase, the player owning the Command ship designates which starcraft and ink clouds they wish to attempt to scan. The player must designate not only the target, but the number of attempts on each target. The Command ship player rolls a D10 for each attempt. A successful roll indicates a successful scan. Scanned ships should be marked with a token noting the TOC of the ship that made the successful scan. The Scanner suite requires as many crew as it can make scanning attempts. If scanner crew are killed the maximum number of scans is limited to the new number of crew.

Example: Ian has two Command Escorts, both with Scanning capability of Scan: 1-7(4), and a TOC of +3. One is in the clear, and the other is in an ink cloud, and has only three scanning crew. Ian needs a 1-7 from the first Escort and a 1-3 to scan from the Escort in the Ink. For the first vessel he allocates two scans each on an ink cloud and a Muskellunge, rolling a 1 and 4, indicating a success on the ink cloud, then a pair of eights indicating failure on the Muskellunge. The Escort with three crew in the Scanning suite scans the ink cloud it is in with all three attempts. For the first escort he The other escort rolls 6, 8, 2, indicating a success on the final roll.

Effects of scans on Ink

Each ship that has a data link with a Command ship reduces its negative modifier to hit anything covered by ink, if the ink has been successfully scanned. This bonus is equal to the TOC rating. Therefore, a TOC +3 would add a +3 to hit ships or Drones in ink during the gunnery phase of a starcraft under a data link with the Command ship. This represents the TOC's ability to override the effects of an Ink Cloud. A ship can only receive the TOC benefits from a single Command ship. If multiple Command ships successfully achieve a scan, only one takes effect. A TOC may not exceed the effects of ink, therefore a TOC 5 still only negates 4 points of ink.

Example: *In the example above, the Escort in the ink now only suffers a -1 penalty, as does any ship within thirty hexes firing into, out of or through the ink due to the +3 TOC.*

- Torpedoes only need to roll for lock-on once per turn while within an area that has been successfully scanned. Each area must be rolled for separately.
- Ink scans work on a seven hex area including the target hex, and the six adjacent hexes.
- Empty areas may be scanned in anticipation of Ink being placed there in the upcoming movement phase.
- When two scanned areas overlap, do not roll for the second area until a torpedo is moving completely out of the first area.
- In conjunction with a TOC, a scan negates one point of obfuscation due to ink per point of TOC bonus with a successful scan.
- A successful scan does not modify the damage delivered for any weapon system or warhead

The Next Millennium

and then gently touched down. He glanced at the mission timer, only eighteen minutes from orbit to ground. That meant that he had roughly twenty-two minutes before his squadron mates arrived to "rescue" him. Not a lot of time, but enough.

No point in making it easy for them, he thought. Kline reached out and killed the power plant for the second time. Without any energy emissions, the fighter would be next to impossible to spot from orbit.

Kline opened the cockpit and looked around. The dark windows of deserted buildings stared back at him like empty eye sockets. There was no sound other than popping and pinging of his ship as it began to cool. Viewing his dismal surroundings, Kline could easily believe that this was Gratton's homeworld.

A half block away, he could see the object of his quest, the Interplanetary Bank of Norvill.

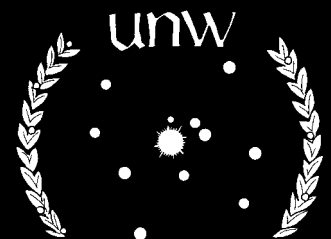

Silent Death

Stepping out onto the wing of his fighter, he made his way over to the starboard pulse laser mount. Kline knelt down beside the access panel and pulled the release catch. Nothing happened.

Damn, he thought, must be jammed from the heat. I don't have time for this.

He grabbed the release firmly, braced himself, and heaved. The access panel came free with a bang and Kline toppled backward off the fighter's wing. A shooting pain lanced through his right ankle as he hit the ground.

Kline swore softly and lay there looking up at the sky for a few moments. He could almost hear Gratton's gravelly voice admonishing him, "Haste makes waste, my friend."

Kline slowly got up and leaned against his ship. Gingerly, he placed his right foot on the ground and shifted his weight to it. It hurt, but not unbearably. Good, he thought, probably not fractured.

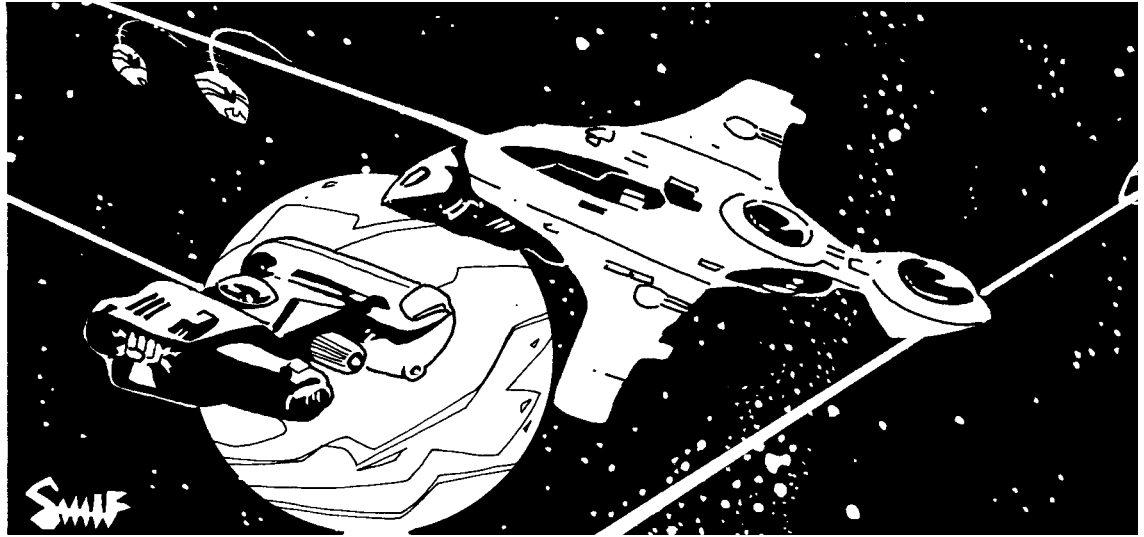

Example: *Jay has successfully scanned two ink cloud areas separated by two unscanned hexes. Normally a torpedo must roll to maintain lock for each hex of ink it passes through. Because of the scanning he must only roll once for the seven hex area. When moving out of the scanned area he must roll for both of the intervening hexes. If any Torpedoes were still left, he would only have to roll once for the next scanned area.*

Data Link Terminus Torpedoes

Drones are one of the most highly effective weapons systems the Hatchlings used against Terran craft. The Grubs would saturate the area around a Terran ship with Drones, effectively preventing it from maneuvering. UNW standard procedure for combating Drones is to clear a path through the Drone field using MK. 10 torpedoes. Although this is impractical in some combat situations, it is the best solution currently available. Other Grub weaponry and systems can also neutralize Terran torpedoes. The Grubs employ two systems that defeat torpedoes: Jump Pods and Ink Clouds. Jump Pods are disposable hyper drive units that allow the Grub ships to perform a mini-jump into hyper space. When a Grub ship uses a Jump Pod, most of the torpedoes targeted at a Grub ship lose their lock on their target and become useless. In space combat, maneuverability is victory. The ability of the Brood to pin down Terran fighters with Drones have caused up

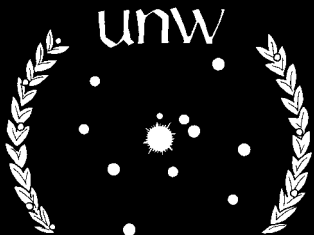

to 80% of the losses the Terrans have suffered in any campaign versus the Grubs. Sadly, torpedoes, one of the primary Terran weapon systems, were inefficient against the Brood. The UNW scientific teams decided to make torpedoes more effective in the battle against the Grubs.

The UNW scientists have developed Data Link Terminus Torpedoes to help counteract the Brood/drone threat. The torpedoes' defensive equipment and programming were removed to make room for data link equipment. The results have been spectacular. UNW ships with escorts are now able to free themselves from the confinement of Drone fields and return to active battle. The primary handicap of this weapon system is the ease with which these Torpedoes may be targeted. This makes it important to used DLTs when a hit is assured on the turn they launch.

- DLT torps have a Drive of 12, Defensive Value of 6, and a Pilot skill of 3.

Effects of Scans on DLT Torpedoes

If the Grub ship that has been scanned uses a Jump Pod, the torpedo only loses track of the ship with a result of 1 on a D4, instead of a 1 or 2 like normal. Likewise, if the torpedo enters the area of effect of an Ink Cloud, the torpedo only loses track of the ship with a result of 1 on a D4. This represents the TOC's ability to track and predict where the Grub ship will end up while using a Jump Pod. It also represents the ability to burn through the effects of an Ink Cloud.



- DLT torps only roll for lock on once per area of scanned ink.
- DLT torps only loose lock on with a result of 1 on 1D4 of a scanned ship that uses a jump pod or is in ink.
- The TOC bonus does not modify the damage delivered, the speed, or the pilot skill of the torpedo.
- If a drone is scanned, or in an area that is scanned, DLT torps may be locked on from any range as if a drone was like any other target.
- DLT Torpedoes targeted on a scanned stationary target move and detonate at the end of the Drive 0 movement phase. (Stationary targets are targets that may not move during a turn, or choose to move during the Drive 0 movement phase.)

Example: *John's fighter has launched two Mark 10 DLT Torpedoes, one at a type 5 Drone and the other at a Muckworm. Because the Drone is not moving the DLT Torp targeted at it will move, and if it reaches the target detonate, at the end of the Drive 0 Movement Phase.*

Example: *Lisa has scanned both a Muckworm and an area of ink. When the Muckworm enters the area of ink the 4 following DLT Torpedoes only have to roll once each for the entire area of ink to maintain lock, because that area has been scanned. She rolls 4,4,2,1, loosing only one torp to the ink because the ship had also been scanned.*

The Next Millennium

Kline hobbled over to the steps set in the side of his fighter and climbed back up onto the wing. He made his way back to the access panel and peered inside the laser mount. The laser generator had been removed, in its place were an insulated satchel filled with thermite charges and a small folding ammo dolly. Kline lowered these to the ground and then climbed down himself.

He quickly unfolded the dolly and placed the satchel on it. Pushing the dolly before him, Kline started toward the bank in a fast, limping run.

Inside the bank, it took only moments to locate the main vault. It was unopened.

"I hope Gratton's right about this," muttered Kline. He opened the satchel and quickly placed the thermite charges on the vault door in the pattern the crew chief had showed him. Kline grabbed the radio detonator from the satchel and retreated

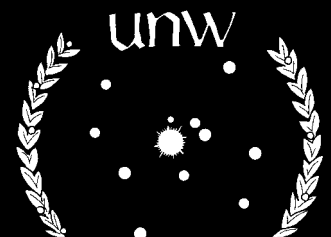

Silent Death

into the next room. Taking cover behind a sturdy-looking counter, he pressed the button.

A wave of heat and a muffled whumph came from the vault room. This was immediately followed by a load crash, as the vault door toppled off its hinges.

Letting out a whoop, Kline ran into the vault. There, stacked neatly in one corner, was a pile of gold bars—a portion of Norvill V's gold reserve.

Kline wheeled the dolly into the vault and began to stack bars on it as fast as he could. Once he judged that he had as heavy a load as he could move, he headed back to the fighter.

At the ship, he engaged the dolly's power lift, elevating the gold to wing level. Kline clambered up onto the wing and began transferring the bars into the laser mount. It was soon full.

Kline climbed down to push the dolly over to the port laser mount. Despite the lightened load, Kline's throbbing ankle slowed him, and

Optional Rules

Enlarging scan area

Each successful scan increases the area being effected. The first success is still seven hexes. The area increases outward by one hex for each success. Using this rule two successful scans on one hex would cover an area of 19 hexes, centered on the target hex. Scans from separate escorts will not enlarge each other.

Damage Penalties

Normally the more difficult a target is to hit, the more damage you do to it if you do connect. To counteract this effect apply any To-Hit penalty to damage as well.

Damage Bonus-Type 1

Apply the excess rolled above the Defensive Value from the To Hit roll to the damage value, on a one for one basis. Do not include the To Hit modifier for the To Hit bonus of Multiple weapons, they already have a damage bonus. Do include modifiers for range. Missiles do not gain this bonus.

Example: *John's Lance Electra attacks Jay's Death Wind with a Pulse Laser and rolls 1, 7, & 8. He would normally do 1 point of damage, but using this rule does 4 points of damage. (At short range it would have done five points). Jay's Deathwind returns fire from the Deathwind rolling 8, 5, and 4. Normally this would do 17 points of damage, but because he rolled over the DV 12 by five, it instead does 22 points of damage.*

Damage Bonus-Type 2

Apply the excess rolled above the Defensive Value from the To Hit roll to the damage value on a variable scale depending on the weapon type. Do not include the To Hit modifier for the To Hit bonus of Multiple weapons, they already have a damage bonus. Do include modifiers for range. Missiles do not gain this bonus.

Low weapons (Pulse Lasers and Miniguns) receive +1 damage for every three points over the defensive value the To Hit roll was.

Medium weapons (Meld Lasers, Splatterguns, Disruptorguns, and Auto-cannons) receive +1 damage for every two points over the defensive value the To Hit roll was.

High weapons (Turbo Lasers, Blatguns, Disintegrators, Impulseguns and Rail Repeaters) receive +1 damage for every point over the defensive value the To Hit roll was.

All weapons and higher (Ion Rams, and Plazguns) receive no damage bonus.

Proto Bolters receive +1 damage for every point over the defensive value the To Hit roll was.

Pilot as copilot

In the event of the copilot's demise, the pilot could fire any weapon system that was assigned to the copilot. When this takes place, the pilot has two options. If the pilot chooses to fire the weapon in more than the forward arc, the starcraft can not move that turn and has a Defensive Value of 5 and can not make a Drive 0 turn. Or, as an alternative, the pilot may choose to fly the starcraft and continue firing the weapon but only in the forward arc. Conversely, if the pilot is killed these same options are available to the surviving copilot.

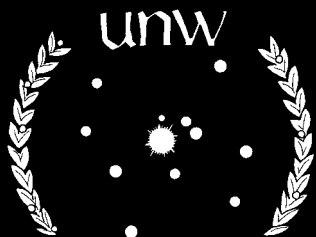

Night Watch Units

"It is the providence of kings to cause war, and God to end it."

—Cardinal Pole, PreImp
1917

"I didn't invite the Grubs into Terran space, but I sure plan to revoke their visiting privileges."

—Gen. Cole, 7 AL

This section outlines in detail the best of the current official Night Watch wings and associated squadrons. Most of the Twelve are represented below. It is common to see the same type of starcraft in many different squadrons due to the Central Command's method of starcraft acquisition and development. The units below are not intended as a complete list of Universal Night Watch squadrons, but only as a representative sample. The individual contributions below are not necessarily all of a particular power's contribution to the UNW.



House Colos

CRIMSON GUARD

Commanding Officer: Lars Venke

House Colos has two Night Watch units; their own independent Night Watch wing, and the Crimson Guard, which is their contribution to the Universal Night Watch. Although the Colosian military participation in the UNW is lukewarm, it was still a matter of pride to contribute a well-trained and well-equipped unit. Only combat tested crews are allowed to apply for Crimson Guard duty. After a crew submits its appli-

cation, they fly several simulated Night Watch missions. Successful applicants are then enrolled in the Night Watch and sent to a secret base for training. The Crimson Guard is a highly capable combat unit. Their pilots, while not the best, are very competent. Colosian gunners are especially outstanding. A heavy belief in "one shot one kill" is stressed during training. Of course, the fact that the Colosians prefer massive weapon systems such as Plazguns probably adds to the one shot slogan.

Although the Crimson Guard is a good unit with a good record, they do not make very good team players. With the emphasis on joint operations by UNW Central Command, this lack of team spirit is a detriment. Over the protests of House Colos, Night Watch commanders have begun experimenting with integrating individual Colosian pilots and gunners into other wings and squadrons.

Squadron Summary

OGRE SQUADRON

Squadron Leader:

Bobba Hommes (Plt 9, Gnr 9)

Assets: 3 x Salamander NW
4 x Hornet
2 x Epping NW

TROLL SQUADRON

Squadron Leader:

Sandy Madson (Plt 9, Gnr 7)

Assets: 6 x Rattler
2 x Equalizer
3 x Javelin

GOBLIN SQUADRON

Squadron Leader:

Erin Eke (Plt 8, Gnr 8)

Assets: 8 x Nighthawk NW
2 x Hornet
2 x Mantis

The Next Millennium

he stumbled repeatedly. He eventually maneuvered the dolly in place and climbed back aboard the ship.

Kline had just removed the port access panel when the cockpit radio crackled to life.

"Baby Bear 1 to Claw 9, Baby Bear 1 to Claw 9, do you read, over."

"Claw 9, if you can hear this transmission be advised, we have just detected four bogies lifting off from coordinates 47 West, 53 North. We are moving to engage."

Kline scrambled across the wing on his hands and knees to the cockpit and peered in at the map displayed on the console. Those coordinates were only one hundred miles from his position! If the bogies were Grub fighters, they would be here in less than ten minutes.

His heart racing, Kline darted back to the access panel. He grabbed gold bars with both hands and tossed them haphazardly into the laser mount. When the dolly was empty, he



Silent Death

slammed the panel shut and kicked it clear of the wing with his right foot. This caused him enough pain that he nearly blacked out.

Taking a few seconds to recover his faculties, he lurched over to the cockpit and jumped in.

Got to get off the ground now, he thought. He scanned the instruments, both capacitors read full. Kline quickly typed his authorization code into the console and punched the ignition button.

Nothing.

He hit it again.

Nothing.

Kline's eyes swept over the instruments. The words "Invalid Authorization" glowed greenly from the console.

"Okay, calm down. You've got time, just take it slow," he told himself.

Carefully, he typed in his code again and pushed the button. Green lights flashed across the board,



House Red Star

NIGHT WINGS

Commanding Officer: Running Fox

House Red Star does not have a strong military tradition; they have been content to live and let live. The wanton destruction of Mars by the Grubs rekindled their fighting spirit, and they have vowed to some day reclaim their Martian homeland. Drawing on ancient legends and beliefs, the members of Red Star's Night Watch unit have dubbed themselves as "Night Wings" and paint themselves and their fighters as nocturnal or mythological creatures of the night. This ritual is to invoke the fighting spirit or "manitou" of the animal portrayed into the fighter and to assist the warrior in maintaining his own manitou. Those chosen to enter the Night Watch service must attend training at the Hino Lodge.

House Red Star has some of the best pilots in any unit. Unfortunately, their gunnery skills are only average. One thing that is never in doubt, however, is their dedication and commitment to battle once combat is initiated. While the Night Wings have developed into a top notch Night Watch unit, they still believe that there is always a better way of solving differences. As one Night Wing pilot was heard to say, "The best way to understand a bug is to get to know it's spirit, then step on it!"

Squadron Summary

SASQUATCH SQUADRON

Squadron Leader:

Gunnodoyak (Plt 9 Gnr 6)

Assets: 6 x Nighthawk NW
8 x Firebat

ALGONQUIN SQUADRON

Squadron Leader:

Nokomis (Plt 8 Gnr 8)

Assets: 2 x Javelin
6 x Firebat
4 x Salamander NW

OWL SQUADRON

Squadron Leader:

Michabo (Plt 10 Gnr 7)

Assets: 2 x Mantis
6 x Teal Hawk NW
2 x Salamander NW



House Tokugawa

DIVINE WIND

Commanding Officer: Toro Hirishito

House Tokugawa was almost completely unprepared for the Grub-Terran War. They remained aloof from the Civil War, and continued to maintain only a small defense force. When the Grubs came, Tokugawans pilots managed to save their main planet of Po Ying in a climactic battle, though they took tremendous losses. Po Yang, their other main planet, remained untouched by the Grubs. After the war, the Tokugawans realized that they would need a strong military to resist Terran and Grub incursions alike. Fortunately, they had no problems finding volunteers for their military forces. The most talented enlistees were sent to Yoka-Shan for training, and simultaneously, retired Yoka-Shan commanders were lured to Po Ying to train and teach in the new military academy.

The Tokugawans have built a strong, well-trained military. Their UNW unit is veteran and highly experienced. Constant training with the Yoka-Shan has helped them maintain their military superiority.

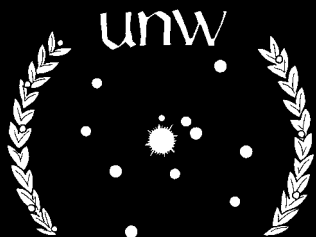

Squadron Summary

KATANA SQUADRON

Squadron Leader:

Idori Nakamuti (Plt 10, Gnr 9)

Assets: 3 x Rattler
4 x Firebat
2 x Javelin

NINJA SQUADRON

Squadron Leader:

Yoko Kadishi (Plt 9, Gnr 9)

Assets: 6 x Firebat
4 x Epping NW
3 x Equalizer

SHOGUN SQUADRON

Squadron Leader:

Takayama Ito (Plt 9, Gnr 10)

Assets: 4 x Hornet
6 x Salamander NW
2 x Mantis



Yoka-Shan Warworlds

THE SORCERERS

Commanding Officer: Braddock
"Lightning" Chen

The Sorcerers are among the oldest and most experienced Night Watch unit in Terran. The unit received its name during the Grub-Terran war because of its uncanny skill in battling the Grubs. The Sorcerers were the first Terran pilots to refit their ships to carry additional racks of missiles. During the war, and in the years that followed, the Sorcerers never lost a battle to the Grubs. Yoka-Shan commanders and cadets are required to study the Sorcerers' training techniques, and their strategies are a model of what successful Grub-busting should be. When the UNW was founded, the Sorcerers officially became the first Night Watch unit.

Only the best and most dedicated warriors join the Sorcerers. Candidates are sent to a specialized military training camp for one year. The training is extremely taxing, the attrition rate is around 40%. Warriors who do not complete the program are not disdained; it is a great honor just to have been chosen. A place in the Sorcerers is considered the highest honor that any Warworlder can receive. Occasionally, select candidates from other planets are invited to join the Sorcerers.

The Sorcerers are marked by their to dedication to the eradication of the Grubs. Their first allegiance is to the UNW; not to their home planets. They believe that the key to defeating the Grubs is Terran unity.

Squadron Summary

JACKAL SQUADRON

Squadron Leader:

Momar Entebe (Plt/9 Gnr/8)

Assets: 8 x Thunder Bird NW
4 x Salamander NW
2 x Equalizer
2 x Javelin

TALISMAN SQUADRON

Squadron Leader:

Sumari Momadu (Plt 10 Gnr 6)

Assets: 6 x Nighthawk NW
4 x Rattler
4 x Epping NW

ZULU SQUADRON

Squadron Leader:

Atokoloinona (Plt 7 Gnr 9)

Assets: 6 x Firebat
2 x Mantis
2 x Hornet

AVALANCHE SQUADRON

Squadron Leader:

Helmut Bucholz (Plt 9 Gnr 7)

Assets: 10 x Thunder Bird NW
10 x Nighthawk NW
4 x Salamander NW
2 x Epping NW

The Next Millennium

flickered briefly to yellow, and then turned red.

"Unstable containment. Auto-shutdown engaged," reported the console.

He had one more try. Kline took a deep breath and pushed the button again.

Green.

Yellow.

Yellow.

Green.

"Fusion ignition successful," glowed the console.

"I knew you could do it, baby," crowed Kline, patting the dash, "Now let's get out of here."

Kline pushed the throttles forward and the Thunderbird lumbered into the air.

"Claw 9 to Baby Bears, I have achieved restart and am now airborne. I could use some assistance."

"Roger that Claw 9, we've got you on our screen. Cavalry's on the way."

Kline flipped on the fighter's sensors. They immediately registered four enemy ships moving in his direc-



Silent Death

tion. Judging from their sensor profiles, Kline guessed they were Larvas. On a good day, he might be able to outrun them, but the ship was responding sluggishly to the controls. Probably the gold, he thought, it's a lot heavier than the laser generators.

Kline brought the Thunderbird around in a wide, slow turn. His sensors detected the four Salamander NWs coming to his aid—he set a course directly for them. On his scanner, he saw the Grub ships alter course to intercept him.

It's a foot race now, Kline thought.

He reduced his rate of climb to gain more speed. The Larvas seemed to be slowly gaining ground on him, but it didn't seem as if they would get within weapon range before the Salamanders reached him.

A few anxious minutes ticked by.

The Salamanders got to Kline first, wagging their wings as they



Kashmere Commonwealth

THE STELLAR HORDE

Commanding Officer: Ismail Vankershef

Built on the principles of commerce and capital gain, the Kashmere Commonwealth has always depended on economic pressure and takeover, not military might, for territorial expansion. They have, however, always maintained a respectable and competent military force to protect their financial interests. Their fighter wings have a good reputation, especially with pirates. Most freebooters think twice about attacking Commonwealth convoys.

When the first Hatchlings appeared in Commonwealth space, the Kashmere dispatched two squadrons of their best fighters to eliminate the bandits. The squadrons were annihilated by the Grub Swarm, and eventually even the Kashmere headquarters on Venus fell. The Kashmere were forced to use their fleet of merchant vessels to evacuate their headquarters and flee to safer parts of the galaxy. Once the last Grub Swarm departed, they quickly set about rebuilding their economic dominance.

Like all of the Twelve, the Kashmere have devoted considerable resources to building a strong military. Cash rich, the Kashmere pay generous salaries to their military, and their ranks have filled not only by their own citizens, but also by mercenaries. The Kashmere have used their military as a very effective tool; their wings have been very successful in protecting Kashmere convoys from the Grubs.

The Commonwealth is an enthusiastic participant in the Night Watch, though they have mixed feelings as to how it will affect their business interests. Fewer Grubs mean more Terrans, and probably more customers, which should, theoretically

mean more business. This has, to some extent been the case. On the other hand, certain members of the UNW have proved remarkably stubborn in refusing to allow the Kashmere to keep the monopolies which they have been building. The UNW has also refused to grant the Kashmere certain exclusive contracts. The Kashmere, however, will not withdraw from the UNW, since this would alienate most of the members of the UNW and cost them a great many customers.

Squadron Summary

MONGOL SQUADRON

Squadron Leader:

Asha Patel (Plt 10, Gnr 8)

Assets: 8 x Firebat
4 x Epping NW
2 x Lance Electra NW

GURKHA SQUADRON

Squadron Leader:

Armene Anklesari (Plt 9, Gnr 9)

Assets: 6 x Firebat
4 x Rattler
2 x Mantis

BRAHMA SQUADRON

Squadron Leader:

Amerind Sagoo (Plt 8, Gnr 8)

Assets: 10 x Firebat
3 x Hornet
3 x Equalizer

Hibernia Freehold

The individualistic and independent Hibernians have always been famous for their small but excellent intelligence network. When the Grubs entered Hibernian space, the Hibernians were ready for them. Encounter for encounter, Hibernian fighter wings entered combats against the Grubs far better prepared than their counterparts in other Grub-busting units. This information gave the Hibernians the edge they needed to survive the onslaught of the Grubs. After the war, Hibernian intelligence modified their network to include a new branch that would specialize in gathering information on the Grubs. When the UNW was founded, the Hibernians naturally of-

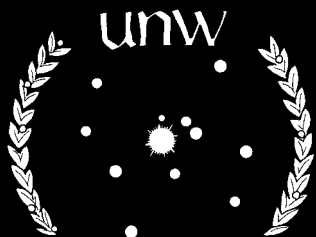

TPV

Mk. 10 DLT Torps

○ ○

○ ○

○ ○

○ ○

○ ○

○ ○

Pilot

Hammerhead Missile Launcher (F)

Lock on < ___

○ ○ ○ ○ ○

○ ○ ○ ○ ○

Gunner

1 Tachyon Ram (FQL) (F) (FQR)

To Hit: 2D10+ADB

Damage: High

Range: 3/11/17

Target SR ≤ 15

Crew

PILOT

Plt: _____

Gnr: _____

Luck: _____

GUNNER

Gnr: _____

Decoys: —

P-D: —

Dmg Con: 1-4

EFS: Type 1

Tons: 300

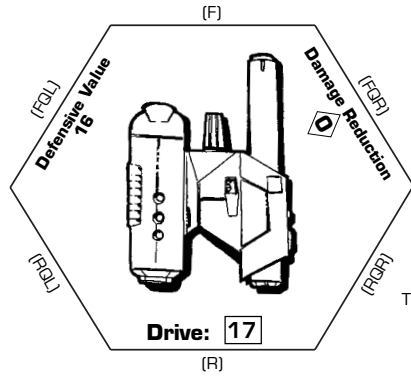

Tight Turn Cost: _____+3

DAMAGE TRACK

→		t		*	17	t		15		w	*	13	t	t	t
	11		t	t	9	w	*	t	7	t	5	t	2		×

TPV

Mk. 10 DLT Torps

○ ○

○ ○

○ ○

○ ○

○ ○

○ ○

Pilot

Hammerhead Missile Launcher (F)

Lock on < ___

○ ○ ○ ○ ○

○ ○ ○ ○ ○

Gunner

1 Tachyon Ram (FQL) (F) (FQR)

To Hit: 2D10+ADB

Damage: High

Range: 3/11/17

Target SR ≤ 15

Crew

PILOT

Plt: _____

Gnr: _____

Luck: _____

GUNNER

Gnr: _____

Decoys: —

P-D: —

Dmg Con: 1-4

EFS: Type 1

Tons: 300

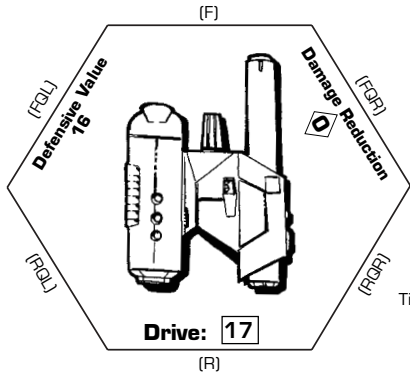

Tight Turn Cost: _____+3

DAMAGE TRACK

→		t		*	17	t		15		w	*	13	t	t	t
	11		t	t	9	w	*	t	7	t	5	t	2		×

CRITICAL HITS

- 2 — **Pilot killed.** Firebat may not move. Lose use of Pilot's weapons. Defensive Value drops to 5.
- 3 — **Missile Launcher hit.** Remove 1D4 remaining missiles
- 4 — **Torpedo Targeter disrupted.** Remaining torps cannot be launched for the remainder of the game.
- 5 — **Major structural damage inflicted.** Firebat takes 1D6 more hits.
- 6 — **Shields damaged.** Reduce Defensive Value by 2.
- 7 — **Pilot's Weapons Targeters damaged.** Reduce all Lock on and To Hit attempts by 2.
- 8 — **Engine thrusters hit.** Reduce Defensive Value by 4.
- 9 — **Weapon malfunction.** Tachyon Ram may not be used until after next game turn.
- 10 — **Engines sputter.** Reduce Drive to 2 for next Movement Phase, then return to normal Drive value.
- 11 — **Gunner killed.** Lose use of Gunner's weapons.
- 12 — **Reactor hit.** Firebat disappears in a brilliant flash of light.

TACHYON RAM SPECS

Short Range: 1-3 hexes (+1 To Hit).

Medium Range: 4-11 hexes.

Long Range: 12-17 hexes (-1 To Hit).

Target Speed Restriction: Target Drive Value must be ≤ 15. Only affects Brood ships.

GAME TURN RECORD TRACK

1	2	3	4	5	6	7	8	9	10	11	12	13	14	15	16	17	18	19	20
---	---	---	---	---	---	---	---	---	----	----	----	----	----	----	----	----	----	----	----

TPV

Pilot
1 Impulsegun (F)
 To Hit: 2D8+ADB
 Damage: High
 Range: 3/8/10

Crew
PILOT
 Plt: _____
 Gnr: _____
 Luck: _____
COPILOT
 Plt: _____
 Gnr: _____
 Luck: _____

Mk. 10 DLT Torps

○	○	○
○	○	○
○	○	○
○	○	○
○	○	○
○	○	○

Pilot or CoPilot
1 Ion Ram (F)
 To Hit: 2D8+ADB
 To Hit: 2D8+ADB
 Damage: All
 Range: 5/13/15
 Target SR ≤15

Decoys: —
 P-D: —
 Dmg Con: 1-6
 EFS: Type 2
 Tons: 600

CoPilot
1 EMP Beam (FQL) (F) (FQR)
 To Hit: 2D8+ADB
 Damage: High ✕
 Range: 3/6/15
 Target SR ≤14

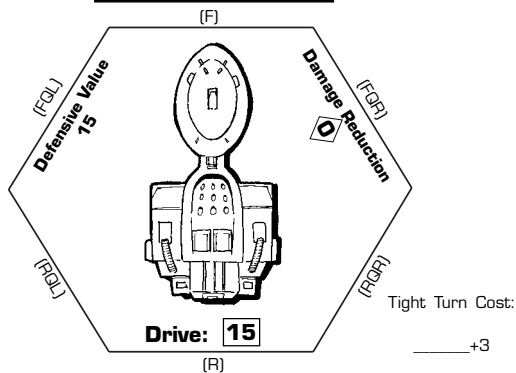

DAMAGE TRACK

→	t		t		15	t		t		W		
	13	t	*		t		11	t		t	w	
	*	9	t			t		7	t		t	w
	*		5	t		t			3	t		×

TPV

Pilot
1 Impulsegun (F)
 To Hit: 2D8+ADB
 Damage: High
 Range: 3/8/10

Crew
PILOT
 Plt: _____
 Gnr: _____
 Luck: _____
COPILOT
 Plt: _____
 Gnr: _____
 Luck: _____

Mk. 10 DLT Torps

○	○	○
○	○	○
○	○	○
○	○	○
○	○	○
○	○	○

Pilot or CoPilot
1 Ion Ram (F)
 To Hit: 2D8+ADB
 To Hit: 2D8+ADB
 Damage: All
 Range: 5/13/15
 Target SR ≤15

Decoys: —
 P-D: —
 Dmg Con: 1-6
 EFS: Type 2
 Tons: 600

CoPilot
1 EMP Beam (FQL) (F) (FQR)
 To Hit: 2D8+ADB
 Damage: High ✕
 Range: 3/6/15
 Target SR ≤14

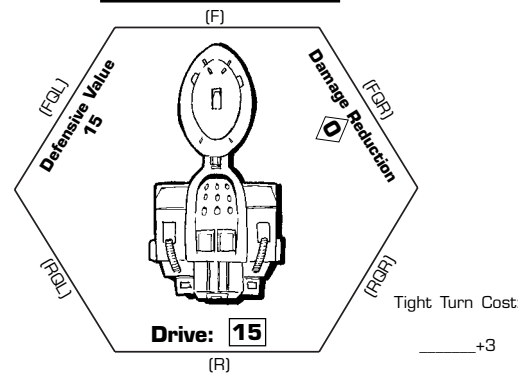

DAMAGE TRACK

→	t		t		15	t		t		W		
	13	t	*		t		11	t		t	w	
	*	9	t			t		7	t		t	w
	*		5	t		t			3	t		×

GAME TURN RECORD TRACK

1	2	3	4	5	6	7	8	9	10	11	12	13	14	15	16	17	18	19	20
---	---	---	---	---	---	---	---	---	----	----	----	----	----	----	----	----	----	----	----

CRITICAL HITS

- 2 — Pilot killed. Switch to CoPilot.
- 3 — Torps Jettison. Remove 1D4 remaining torps.
- 4 — Torpedo disruption. Hornet may not launch torps for the remainder of the game.
- 5 — Major Structural Damage inflicted. Vessel takes 1D10 more hits.
- 6 — Shields damaged. Reduce Defensive Value by 4.
- 7 — EMP Beam disrupted. If the beam is fired, this ship suffers another critical.
- 8 — Evade thrusters hit. Reduce Defensive Value by 4.
- 9 — Weapon malfunction. One random weapon system may not be fired until after the next turn.
- 10 — Engines sputter. Reduce Drive to 2 for the next Movement Phase, then return to normal Drive value.
- 11 — CoPilot killed. Lose use of his weapons.
- 12 — Reactor hit. Hornet is exterminated and flies no more.

EMP BEAM SPECS ✕

Short Range: 1-3 hexes (+1 To Hit).
 Medium Range: 4-6 hexes.
 Long Range: 7-15 hexes (-1 To Hit).
 Target Speed Restriction: Target's Drive value must be ≤14.
 ✕ Ignores Damage Reduction.
 Whenever doubles or triples are rolled on a hit, the target takes a critical in addition to other damage.
 Does 1/2 damage to Terran ships.

IMPULSEGUN SPECS

Short Range: 1-3 hexes (+1 To Hit).
 Medium Range: 3-8 hexes.
 Long Range: 9-10 hexes (-1 To Hit).

ION RAM SPECS

Short Range: 1-5 hexes (+1 To Hit).
 Medium Range: 6-13 hexes.
 Long Range: 14-15 hexes (-1 To Hit).
 Target Speed Restriction: Target's Drive value must be ≤15.

TPV

Gunner A
Hammerhead Missile Launcher
 (BRQL) (BFQL) (F)
 Lock-on < ____
 ○ ○ ○ ○ ○
 ○ ○ ○ ○ ○
 ○ ○ ○ ○ ○
 ○ ○ ○ ○ ○

Gunner A

Gunner A
4 Splatterguns
 (BRQL) (BFQL) (F)
 To Hit: 2D6+ADB+3
 Damage: Medium+6
 Range: 2/6/10

Gunner C
2 Meld Lasers
 (BFQL) (F)
 To Hit: 2D8+ADB+1
 Damage: Medium+1
 Range: 6/18/20
 Target SR≤12

Gunner B
4 Splatterguns
 (F) (BFQR) (BRQR)
 To Hit: 2D6+ADB+3
 Damage: Medium+6
 Range: 2/6/10

Gunner D
2 Meld Lasers
 (F) (BFQR)
 To Hit: 2D8+ADB+1
 Damage: Medium+1
 Range: 6/18/20
 Target SR≤12

Gunner B

Gunner B
Hammerhead Missile Launcher
 (F) (BFQR) (BRQR)
 Lock-on < ____
 ○ ○ ○ ○ ○
 ○ ○ ○ ○ ○
 ○ ○ ○ ○ ○
 ○ ○ ○ ○ ○

Crew
CAPTAIN
 Cpn: _____
PILOT
 Plt: _____
GUNNER A
 Gnr: _____
GUNNER B
 Gnr: _____
GUNNER C
 Gnr: _____
GUNNER D
 Gnr: _____
GUNNER E
 Gnr: _____
GUNNER F
 Gnr: _____

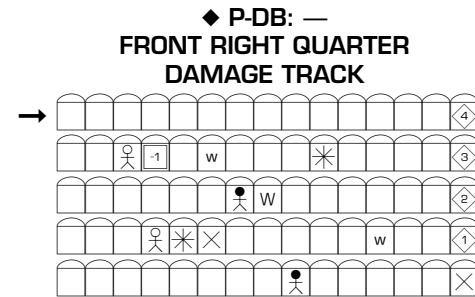
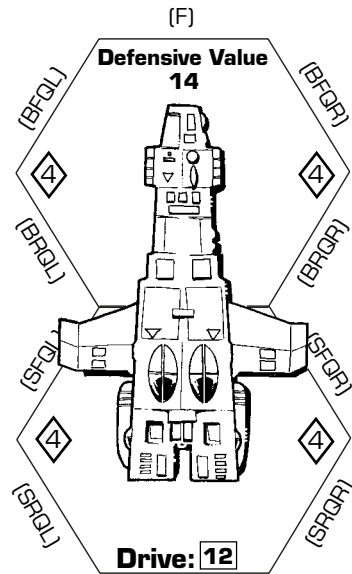
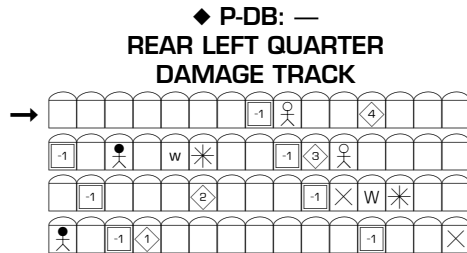
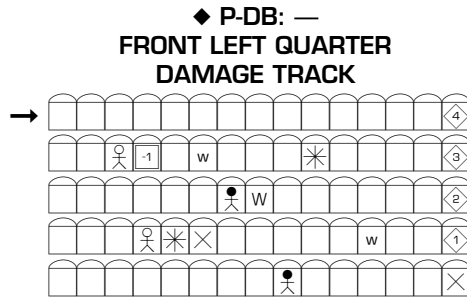

Gunner E
Hammerhead Missile Launcher
 (SFQL) (SRQL) (R)
 Lock-on < ____
 ○ ○ ○ ○ ○
 ○ ○ ○ ○ ○
 ○ ○ ○ ○ ○
 ○ ○ ○ ○ ○

Gunner E

Gunner E
4 Splatterguns
 (SFQL) (SRQL) (R)
 To Hit: 2D6+ADB+3
 Damage: Medium+6
 Range: 2/6/10

Gunner F

Gunner F
4 Splatterguns
 (R) (SRQR) (SFQR)
 To Hit: 2D6+ADB+3
 Damage: Medium+6
 Range: 2/6/10

Gunner F
Hammerhead Missile Launcher
 (R) (SRQR) (SFQR)
 Lock-on < ____
 ○ ○ ○ ○ ○
 ○ ○ ○ ○ ○
 ○ ○ ○ ○ ○
 ○ ○ ○ ○ ○

Turn Cost: 4

FRONT LEFT CRITICAL HITS

- 2 — **Pilot stunned.** Falcon may not move next turn.
- 3 — **Structural damage.** Take 10 more hits on this track.
- 4 — **Special Equipment hit.** Scanner spread reduced by 1.
- 5 — **TOC hit.** Reduce by 1.
- 6 — **Too Tough!** No extra damage.
- 7 — **Gunner A killed.**
- 8 — **Launcher malfunction.** One random launcher loses 1D10 missiles.
- 9 — **Weapon's power flickering.** One random weapon's damage rating drops a level.
- 10 — **Splattergun C hit.** Reduce To Hit by 4 and reduce damage to Medium.
- 11 — **Bridge hit.** Bridge crew is stunned. Falcon may not move or use Captain's Die next turn.
- 12 — **Major structural damage.** Take 15 more hits on this track.

FALCON NW

FRONT RIGHT CRITICAL HITS

- 2 — **Pilot stunned.** Falcon may not move next turn.
- 3 — **Structural damage.** Take 10 more hits on this track.
- 4 — **Special Equipment hit.** Scanner spread reduced by 1.
- 5 — **TOC hit.** Reduce by 1.
- 6 — **Too Tough!** No extra damage.
- 7 — **Gunner B killed.**
- 8 — **Launcher malfunction.** One random launcher loses 1D10 missiles.
- 9 — **Weapon's power flickering.** One random weapon's damage rating drops a level.
- 10 — **Splattergun D hit.** Reduce To Hit by 4 and reduce damage to Medium.
- 11 — **Bridge hit.** Bridge crew is stunned. Falcon may not move or use Captain's Die next turn.
- 12 — **Major structural damage.** Take 15 more hits on this track.

Electronics

Jam: 1-2 on 1D4
Scanners: 1-7 (6)



Bridge

Captain: _____
Pilot: _____
TOC: +5

Engineering

Damage Control: 1-4

EFS: None



REAR LEFT CRITICAL HITS

- 2 — **Gunner E Missile Launcher hit.** Lose 1D10 missiles.
- 3 — **TOC hit.** Reduce by 1.
- 4 — **Power Coupling hit.** No weapons may be fired until after next turn.
- 5 — **Special Equipment hit.** Reduce Scanner attempts by 1.
- 6 — **Gunner E targeting scanners hit.** Reduce To Hit and Lock On values by 4.
- 7 — **Weapon jams.** One random weapon may not be fired next turn.
- 8 — **Engines sputter.** Reduce Drive by 2 until after next turn.
- 9 — **Gunner E killed.** Gunner E's weapons may no longer be fired.
- 10 — **Engineering Section destroyed.** Damage control is not available.
- 11 — **Bridge Hit!** Captain is killed. Player may no longer use Captain's Die.
- 12 — **Reactor hit.** Falcon becomes a gaseous cloud.

REAR RIGHT CRITICAL HITS

- 2 — **Gunner F Missile Launcher hit.** Lose 1D10 missiles.
- 3 — **TOC hit.** Reduce by 1.
- 4 — **Power Coupling hit.** No weapons may be fired until after next turn.
- 5 — **Special Equipment hit.** Reduce Scanner attempts by 1.
- 6 — **Gunner F targeting scanners hit.** Reduce To Hit and Lock On values by 4.
- 7 — **Weapon jams.** One random weapon may not be fired next turn.
- 8 — **Engines sputter.** Reduce Drive by 2 until after next turn.
- 9 — **Gunner F killed.** Gunner F's weapons may no longer be fired.
- 10 — **Engineering Section destroyed.** Damage control is not available.
- 11 — **Bridge Hit!** Captain is killed. Player may no longer use Captain's Die.
- 12 — **Reactor hit.** Falcon becomes a gaseous cloud.

RATTLER NW

I.D.

BPV: 70

TPV

Mk. 10 DLT Torps

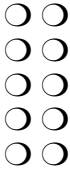

Pilot
1 EMP Ray (F)
To Hit: 2D8+ADB
Damage: Medium \square
Range: 2/4/8

Gunner
6 Splatterguns (FQL) (F) (FQR)
To Hit: 2D6+ADB+5
Damage: Medium+10
Range: 2/6/10

Crew
PILOT
Plt: _____
Gnr: _____
GUNNER
Gnr: _____

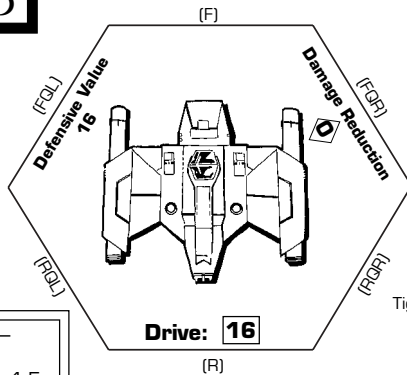

Tight Turn Cost: _____+3

Decoys: —
P-D: —
Dmg Con: 1-5
EFS: TYPE 1
Tons: 400

DAMAGE TRACK

→			t	*	16			t		14
		t		w	12	t	*			10
	t			t	8			w	t	6
	*	t			4	t				×

RATTLER NW

I.D.

BPV: 70

TPV

Mk. 10 DLT Torps

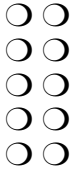

Pilot
1 EMP Ray (F)
To Hit: 2D8+ADB
Damage: Medium \square
Range: 2/4/8

Gunner
6 Splatterguns (FQL) (F) (FQR)
To Hit: 2D6+ADB+5
Damage: Medium+10
Range: 2/6/10

Crew
PILOT
Plt: _____
Gnr: _____
GUNNER
Gnr: _____

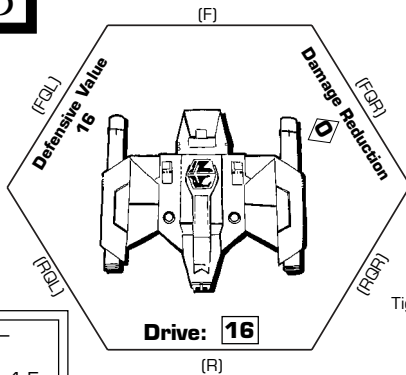

Tight Turn Cost: _____+3

Decoys: —
P-D: —
Dmg Con: 1-5
EFS: TYPE 1
Tons: 400

DAMAGE TRACK

→			t	*	16			t		14
		t		w	12	t	*			10
	t			t	8			w	t	6
	*	t			4	t				×

CRITICAL HITS

- 2 — Pilot killed. Rattler may not move, nor may the pilot's EMP Ray fire. Defensive Value drops to 5.
- 3 — Torps Jettison. Remove 1D4 remaining torps.
- 4 — Pilot's Weapon Targeters damaged. Reduce all Pilot To Hit chances by 2.
- 5 — Major Structural damage. Rattler takes 1D6 more hits.
- 6 — Shields damaged. Reduce Defensive Value by 2.
- 7 — EMP Ray disrupted. If the ray is fired, this ship suffers another critical.
- 8 — Evade Thrusters hit. Reduce Defensive Value by 4.
- 9 — Splatterguns hit. Splatterguns may not be fired until the next game turn.
- 10 — Engines sputter. Drive reduced to 2 until after next game turn.
- 11 — Gunner killed. Gunner's Splatterguns may not be fired.
- 12 — Reactor hit. Rattler is gutted by an internal fire and drifts as an empty husk.

EMP RAY SPECS

Short Range: 1-2 hexes (+1 To Hit).
Medium Range: 3-4 hexes.
Long Range: 5-8 hexes (-1 To Hit).
 \square Ignores Damage Reduction.
 Whenever doubles or triples are rolled on a hit, the target takes a critical in addition to other damage.
 Does 1/2 damage to Terran ships.

SPLATTERGUN SPECS

Short Range: 1-2 hexes (+1 To Hit).
Medium Range: 3-6 hexes.
Long Range: 7-10 hexes (-1 To Hit).

GAME TURN RECORD TRACK

1	2	3	4	5	6	7	8	9	10	11	12	13	14	15	16	17	18	19	20
---	---	---	---	---	---	---	---	---	----	----	----	----	----	----	----	----	----	----	----

TPV

Decoys: —
P-D: —
Dmg Con: 1-6
EFS: Type 2
Tons: 1000

Pilot

4 Splatterguns (F)
To Hit: 2D6+ADB+3
Damage: Medium+6
Range: 2/6/10

Crew

PILOT
Pit: _____
Gnr: _____
Luck: _____

GUNNER A
Gnr: _____

GUNNER B
Gnr: _____

Pilot

Hammerhead Missile Launcher (F)
Lock-on < _____

○○○○○○○○○○○○○○○○

○○○○○○○○○○○○○○○○

Gunner A

Hammerhead Missile Launcher
(RQL) (FQL) (F)
Lock-on < _____

○○○○○○ ○○○○○○

○○○○○○ ○○○○○○

Gunner B

Hammerhead Missile Launcher
(F) (FQR) (RQR)
Lock-on < _____

○○○○○○ ○○○○○○

○○○○○○ ○○○○○○

Gunner A

4 Splatterguns
(RQL) (FQL) (F)
To Hit: 2D6+ADB+3
Damage: Medium+6
Range: 2/6/10

Gunner B

4 Splatterguns
(F) (FQR) (RQR)
To Hit: 2D6+ADB+3
Damage: Medium+6
Range: 2/6/10

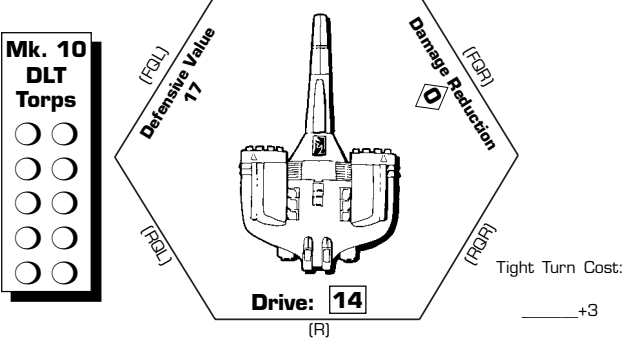

DAMAGE TRACK

→				t					t			14	w	
			t					*	12	W				t
					w	10			t					
	t		W	*	8									
			6			t	w							*
		4			t				t					
	2			w		t		×						

TPV

Decoys: —
P-D: —
Dmg Con: 1-6
EFS: Type 2
Tons: 1000

Pilot

4 Splatterguns (F)
To Hit: 2D6+ADB+3
Damage: Medium+6
Range: 2/6/10

Crew

PILOT
Pit: _____
Gnr: _____
Luck: _____

GUNNER A
Gnr: _____

GUNNER B
Gnr: _____

Pilot

Hammerhead Missile Launcher (F)
Lock-on < _____

○○○○○○○○○○○○○○○○

○○○○○○○○○○○○○○○○

Gunner A

Hammerhead Missile Launcher
(RQL) (FQL) (F)
Lock-on < _____

○○○○○○ ○○○○○○

○○○○○○ ○○○○○○

Gunner B

Hammerhead Missile Launcher
(F) (FQR) (RQR)
Lock-on < _____

○○○○○○ ○○○○○○

○○○○○○ ○○○○○○

Gunner A

4 Splatterguns
(RQL) (FQL) (F)
To Hit: 2D6+ADB+3
Damage: Medium+6
Range: 2/6/10

Gunner B

4 Splatterguns
(F) (FQR) (RQR)
To Hit: 2D6+ADB+3
Damage: Medium+6
Range: 2/6/10

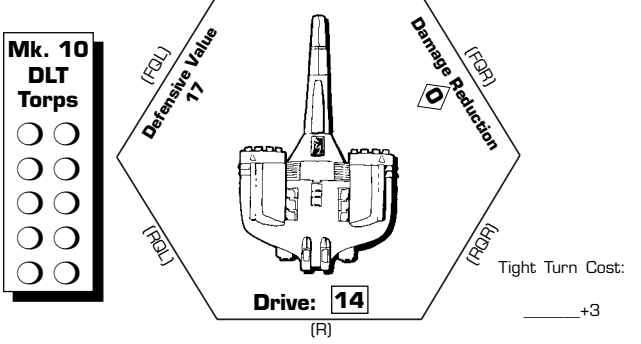

DAMAGE TRACK

→				t					t			14	w	
			t					*	12	W				t
					w	10			t					
	t		W	*	8									
			6			t	w							*
		4			t				t					
	2			w		t		×						

CRITICAL HITS

- 2 — **Pilot killed.** Mantis may not move nor fire Pilot weapons. Defensive Value drops to 5.
- 3 — **Torps jettison.** Remove 1D4 of the remaining torps.
- 4 — **Missile malfunction.** One random Missile Launcher loses 1D6 of its remaining missiles.
- 5 — **Major structural damage.** Mantis takes 1D6 more hits.
- 6 — **Shields damaged.** Reduce Defensive Value by 3.
- 7 — **Weapon Targeters damaged.** Reduce all To Hit chances by 2 on a random remaining weapon.
- 8 — **Evade Thrusters hit.** Reduce Defensive Value by 4.
- 9 — **Weapons malfunction.** One random remaining weapon may not be fired until after the next game turn.
- 10 — **Engines sputter.** Reduce Drive to 2 for the next Movement Phase, then return to normal Drive value.
- 11 — **Gunner killed.** One random Gunner is killed. Lose use of that Gunner's weapons.
- 12 — **Reactor hit.** The Mantis "preys" no more.

SPLATTERGUN SPECS

Short Range: 1-2 hexes (+1 To Hit).
Medium Range: 3-6 hexes.
Long Range: 7-10 hexes (-1 To Hit).

TPV

Mk. 10 DLT Torps

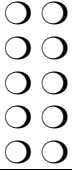

Pilot
4 Blatguns (F)
 To Hit: 2D6+ADB+3
 Damage: High+6
 Range: 4/10/15
 Target SR ≤13

Pilot
Hammerhead Missile Launcher (F)
 Lock-on < _____

Crew
PILOT
 Plt: _____
 Gnr: _____
 Luck: _____
GUNNER A
 Gnr: _____
GUNNER B
 Gnr: _____

Decoys: —
 P-D: —
 Dmg Con: 1-8
 Tons: 1500

Scanner: 1-6 (3)
 TOC: +1

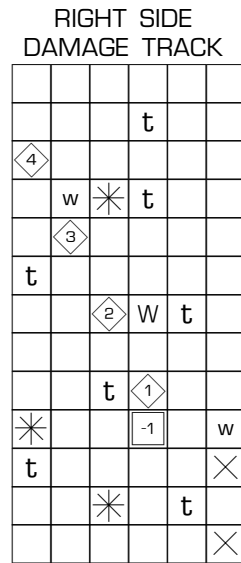
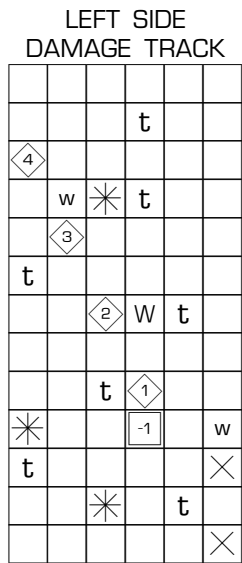
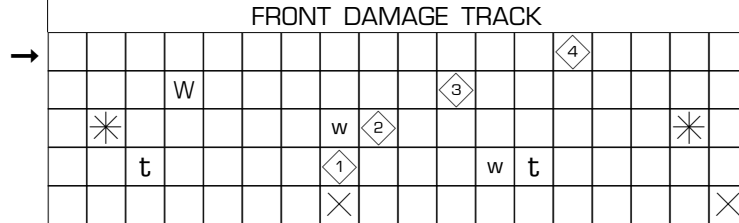

Gunner A
Hammerhead Missile Launcher
 (RQL) (FQL) (F)
 Lock-on < _____

Gunner B
Hammerhead Missile Launcher
 (F) (FQR) (RQR)
 Lock-on < _____

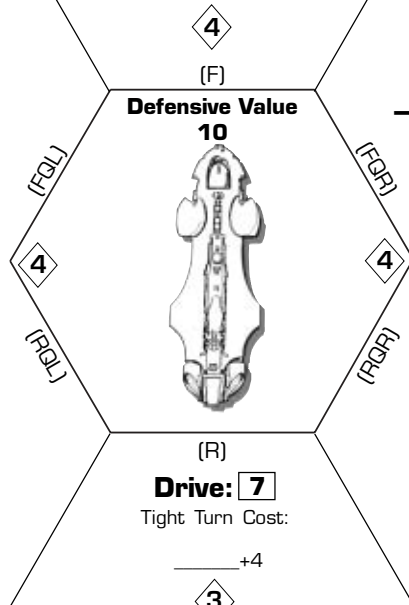

- FRONT CRITICAL HITS**
- 2 — Blatguns damaged. Penalize To Hit attempts by -2 and reduce Damage rating to High+2.
 - 3 — TOC destroyed. Cannot use TOC or Data Link.
 - 4 — Scanner hit. Reduce to 1-5 (1).
 - 5 — Too tough! No extra damage.
 - 6 — Scanner hit. May not be used until end of next game turn.
 - 7 — Pilot's Missile Launcher malfunctions. Lose 1D10 of remaining missiles.
 - 8 — Pilot dazed. Betafort may not move nor fire Pilot's weapons until after next game turn.

- LEFT SIDE CRITICAL HITS**
- 2 — Major structural damage. Take 5 more hits on Left and Right Damage Tracks.
 - 3 — Torp Targeter damaged. No torps can be fired until after next game turn.
 - 4 — Shields damaged. Reduce Defensive Value by 1.
 - 5 — Too tough! No extra damage.
 - 6 — Missile Launcher A hit. Lose 1D10 of remaining missiles.
 - 7 — Minor structural damage. Take 3 more hits on this Damage Track.
 - 8 — Scanner Crew hit. Mark off one crewmember.

- RIGHT SIDE CRITICAL HITS**
- 2 — Major structural damage. Take 5 more hits on Left and Right Damage Tracks.
 - 3 — Torp Targeter damaged. No torps can be fired until after next game turn.
 - 4 — Shields damaged. Reduce Defensive Value by 1.
 - 5 — Too tough! No extra damage.
 - 6 — Missile Launcher D hit. Lose 1D10 of remaining missiles.
 - 7 — Minor structural damage. Take 3 more hits on this Damage Track.
 - 8 — Scanner Crew hit. Mark off one crewmember.

- REAR CRITICAL HITS**
- 2 — Rear bulkhead collapse. Take 8 more hits on this Damage Track.
 - 3 — Power interrupted. Blatguns, TOC and Scanner may not be used until after next turn.
 - 4 — Shields damaged. Reduce Defensive Value by 1.
 - 5 — Engine chokes. Drive reduced by 2 next turn.
 - 6 — Maneuver Thrusters hit. All turns cost 1 extra movement point to perform.
 - 7 — One random Gunner killed. His or her weapons may not be fired.
 - 8 — Reactor detonates. The mighty Betafort passes into the void.

BPV: 49 I.D. NIGHT HAWK NW

TPV

Pilot
6 Splatterguns (F)
 To Hit: 2D6+ADB+5
 Damage: Medium+10
 Range: 2/6/10

Crew
PILOT
 Plt: _____
 Gnr: _____
 Luck: _____

Pilot
Hammerhead
Missile Launcher (F)
 Lock-on < _____
 ○○○○○ ○○○○○
 ○○○○○ ○○○○○

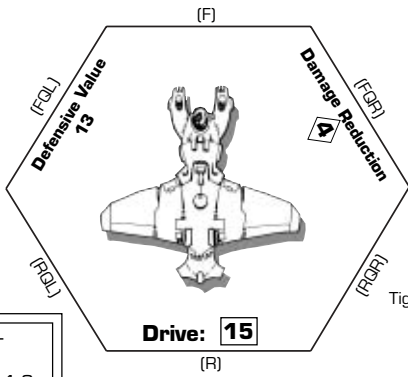

Decoys: —
 P-D: —
 Dmg Con: 1-3
 Tons: 300

Tight Turn Cost: _____+3

DAMAGE TRACK

→	15	4	*	14	3	13	W	2
	12	1	11	10	*	9	W	8
	7	6	5	4	3	1		×

BPV: 49 I.D. NIGHT HAWK NW

TPV

Pilot
6 Splatterguns (F)
 To Hit: 2D6+ADB+5
 Damage: Medium+10
 Range: 2/6/10

Crew
PILOT
 Plt: _____
 Gnr: _____
 Luck: _____

Pilot
Hammerhead
Missile Launcher (F)
 Lock-on < _____
 ○○○○○ ○○○○○
 ○○○○○ ○○○○○

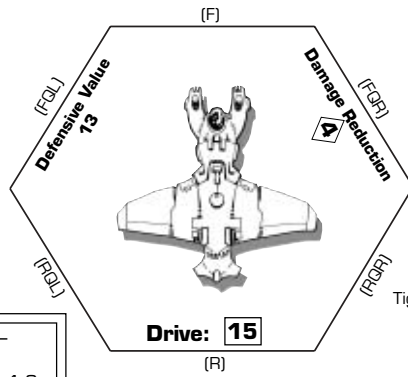

Decoys: —
 P-D: —
 Dmg Con: 1-3
 Tons: 300

Tight Turn Cost: _____+3

DAMAGE TRACK

→	15	4	*	14	3	13	W	2
	12	1	11	10	*	9	W	8
	7	6	5	4	3	1		×

CRITICAL HITS

- 2 — **Pilot killed.** Night Hawk may perform no further actions. Defensive Value drops to 5.
- 3 — **Engines sputter.** Night Hawk may only use 3 movement points next turn. Reduce Defensive Value by 6.
- 4 — **Datalink knocked out.** Night Hawk may no longer benefit from scanning. Reduce Defensive Value by 5.
- 5 — **Maneuver Thrusters damaged.** All turns, including tight turns, cost one extra movement point to perform.
- 6 — **Shields damaged.** Reduce Defensive Value by 2.
- 7 — **Missile Launcher hit.** Lose all remaining missiles.
- 8 — **Splattergun Targeters damaged.** Splatterguns may not be fired until after the next game turn.
- 9 — **Hull compromised.** Reduce Defensive Value by 4.
- 10 — **Severe structural damage.** Reduce Defensive Value by 6. Modify Night Hawk's further To Hit attempts by -4.
- 11 — **Pilot dazed.** Night Hawk may not move or fire until after the next game turn.
- 12 — **Reactor hit.** Night Hawk explodes and is utterly destroyed.

SPLATTERGUN SPECS

Short Range: 1-2 hexes (+1 To Hit).
Medium Range: 3-6 hexes.
Long Range: 7-10 hexes (-1 To Hit).

GAME TURN RECORD TRACK

1	2	3	4	5	6	7	8	9	10	11	12	13	14	15	16	17	18	19	20
---	---	---	---	---	---	---	---	---	----	----	----	----	----	----	----	----	----	----	----

SALAMANDER NW

I.D. ■

BPV: 67

TPV

Pilot
1 Impulsegun (F)
 To Hit: 2D8+ADB
 Damage: High
 Range: 3/8/10

Crew
PILOT
 Plt: _____
 Gnr: _____
 Luck: _____
GUNNER
 Gnr: _____

Mk. 10
 DLT
 Torps

Pilot
**Hammerhead
 Missile Launcher (F)**
 Lock-on < _____

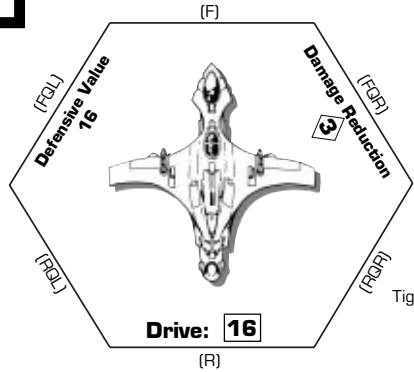

Tight Turn Cost: _____+3

Decoys: —
 P-D: —
 Dmg Con: 1-6
 Tons: 400

Gunner
**2 Splatterguns
 (RQL) (R) (RQR)**
 To Hit: 2D6+ADB+1
 Damage: Medium+2
 Range: 2/6/10

DAMAGE TRACK

16	15	3	W	14	*	13	t	2	12
W	11	1	t	10	*	t	9	8	W
7	6	5	t	4	3	2	1		X

SALAMANDER NW

I.D. ■

BPV: 67

TPV

Pilot
1 Impulsegun (F)
 To Hit: 2D8+ADB
 Damage: High
 Range: 3/8/10

Crew
PILOT
 Plt: _____
 Gnr: _____
 Luck: _____
GUNNER
 Gnr: _____

Mk. 10
 DLT
 Torps

Pilot
**Hammerhead
 Missile Launcher (F)**
 Lock-on < _____

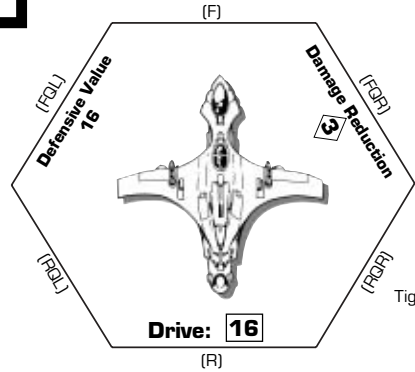

Tight Turn Cost: _____+3

Decoys: —
 P-D: —
 Dmg Con: 1-6
 Tons: 400

Gunner
**2 Splatterguns
 (RQL) (R) (RQR)**
 To Hit: 2D6+ADB+1
 Damage: Medium+2
 Range: 2/6/10

DAMAGE TRACK

16	15	3	W	14	*	13	t	2	12
W	11	1	t	10	*	t	9	8	W
7	6	5	t	4	3	2	1		X

CRITICAL HITS

- 2 — **Crew killed.** Salamander may perform no further actions. Defensive Value drops to 5.
- 3 — **Engines sputter.** Salamander may only use 3 movement points next game turn. Reduce Defensive Value by 5 due to additional damage.
- 4 — **Datalink knocked out.** Salamander may no longer benefit from scanning. Reduce Defensive Value by 5.
- 5 — **Maneuver Thrusters damaged.** All turns, including tight turns, cost one extra movement point to perform.
- 6 — **Shields damaged.** Reduce Defensive Value by 4.
- 7 — **Ionizers fizzle.** Reduce Impulsegun's Damage to Medium.
- 8 — **Torp Targeting Scanner damaged.** No torpedoes may be fired until after the next game turn.
- 9 — **Hull buckles.** Reduce Defensive Value by 5 and lose one torp.
- 10 — **Gunner killed.** Salamander may no longer use Splatterguns.
- 11 — **Pilot dazed.** Salamander may not move or fire Pilot's weapons until after the next game turn.
- 12 — **Reactor hit.** Salamander explodes into oblivion.

IMPULSEGUN SPECS

Short Range: 1-3 hexes (+1 To Hit).
 Medium Range: 4-8 hexes.
 Long Range: 9-10 hexes (-1 To Hit).

SPLATTERGUN SPECS

Short Range: 1-2 hexes (+1 To Hit).
 Medium Range: 3-6 hexes.
 Long Range: 7-10 hexes (-1 To Hit).

GAME TURN RECORD TRACK

1	2	3	4	5	6	7	8	9	10	11	12	13	14	15	16	17	18	19	20
---	---	---	---	---	---	---	---	---	----	----	----	----	----	----	----	----	----	----	----

BPV: 50 I.D. TEAL HAWK NW

TPV

Pilot or Gunner
2 Blatguns (F)
 To Hit: 2D6+ADB+1
 To Hit: 2D6+ADB+1
 Damage: High+2
 Range: 4/10/15
 Target SR ≤13

Crew
PILOT
 Plt: _____
 Gnr: _____
 Luck: _____
GUNNER
 Gnr: _____

Mk. 10
 DLT
 Torp

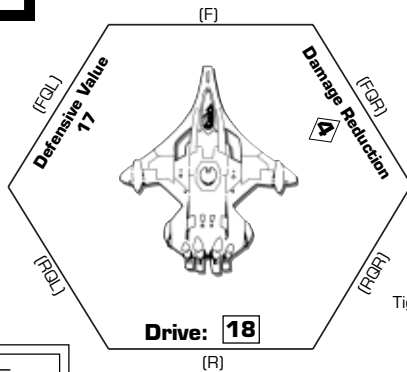

Tight Turn Cost: _____+3

Decoys: —
 P-D: —
 Dmg Con: 1-3
 Tons: 300

DAMAGE TRACK

→	18	4	*	17	16	3	t	15			
	2	14	1	13	w	12		11			
	10	9	8	7	6	5	4	3	2	1	×

BPV: 50 I.D. TEAL HAWK NW

TPV

Pilot or Gunner
2 Blatguns (F)
 To Hit: 2D6+ADB+1
 To Hit: 2D6+ADB+1
 Damage: High+2
 Range: 4/10/15
 Target SR ≤13

Crew
PILOT
 Plt: _____
 Gnr: _____
 Luck: _____
GUNNER
 Gnr: _____

Mk. 10
 DLT
 Torp

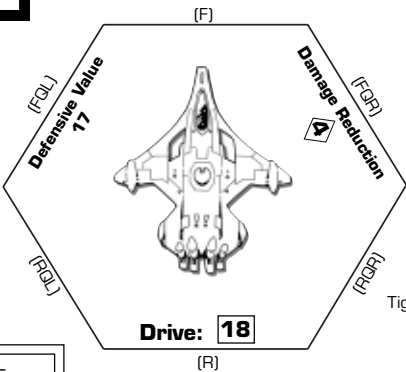

Tight Turn Cost: _____+3

Decoys: —
 P-D: —
 Dmg Con: 1-3
 Tons: 300

DAMAGE TRACK

→	18	4	*	17	16	3	t	15			
	2	14	1	13	w	12		11			
	10	9	8	7	6	5	4	3	2	1	×

CRITICAL HITS

- 2 — **Crew killed.** Teal Hawk may perform no further actions. Defensive Value drops to 5.
- 3 — **Engines sputter.** Teal Hawk may only use 4 movement points next game turn. Reduce Defensive Value by 7 due to additional damage.
- 4 — **Datalink knocked out.** Teal Hawk may no longer benefit from scanning. Reduce Defensive Value by 5.
- 5 — **Maneuver Thrusters damaged.** All turns, including tight turns, cost one extra movement point to perform.
- 6 — **Shields damaged.** Reduce Defensive Value by 3.
- 7 — **Pilot's Trigger Mechanism jams.** Pilot may not use Blatguns.
- 8 — **Blatgun Targeters damaged.** Blatguns may not be fired until after the next game turn.
- 9 — **Hull compromised.** Reduce Defensive Value by 5.
- 10 — **Gunner killed.** Teal Hawk may not use the gunner's ADB for the Blatgun weapon system.
- 11 — **Pilot dazed.** Teal Hawk may not move until after the next game turn. Only the gunner may fire the Blatguns while the pilot is dazed.
- 12 — **Reactor hit.** Teal Hawk explodes and is destroyed.

BLATGUN SPECS

Short Range: 1-4 hexes (+1 To Hit).
Medium Range: 5-10 hexes.
Long Range: 11-15 hexes (-1 To Hit).
Target Speed Restriction: Target's Drive value must be ≤13.
Special Note: The Teal Hawk's Blatgun weapons may be fired by the Pilot or the Gunner, and the firer may change turn to turn. Use the correct ADB.

GAME TURN RECORD TRACK

1	2	3	4	5	6	7	8	9	10	11	12	13	14	15	16	17	18	19	20
---	---	---	---	---	---	---	---	---	----	----	----	----	----	----	----	----	----	----	----

I.D. ■ BPV: 32 THUNDER BIRD NW

TPV

Pilot
4 Pulse Lasers (F)
 To Hit: 2D8+ADB+3
 Damage: Low+3
 Range: 3/9/10

Crew
PILOT
 Plt: _____
 Gnr: _____
 Luck: _____

Mk. 10 DLT Torps

Pilot
Hammerhead Missile Launcher (F)
 Lock-on < ____

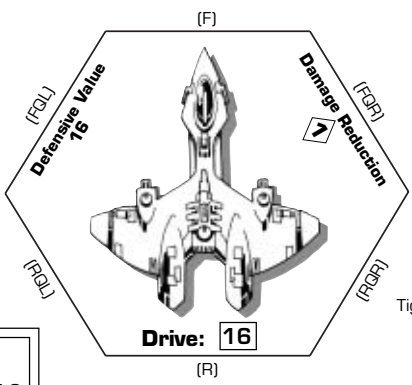

Tight Turn Cost: _____+3

Decoys: —
 P-D: —
 Dmg Con: 1-3
 Tons: 200

DAMAGE TRACK

→		16	◇	*	14	w	t		11	
	t	*		9	w		5	t	1	×

I.D. ■ BPV: 32 THUNDER BIRD NW

TPV

Pilot
4 Pulse Lasers (F)
 To Hit: 2D8+ADB+3
 Damage: Low+3
 Range: 3/9/10

Crew
PILOT
 Plt: _____
 Gnr: _____
 Luck: _____

Mk. 10 DLT Torps

Pilot
Hammerhead Missile Launcher (F)
 Lock-on < ____

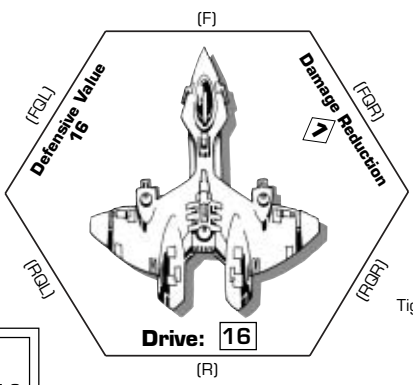

Tight Turn Cost: _____+3

Decoys: —
 P-D: —
 Dmg Con: 1-3
 Tons: 200

DAMAGE TRACK

→		16	◇	*	14	w	t		11	
	t	*		9	w		5	t	1	×

- CRITICAL HITS**
- 2 — **Pilot killed.** Thunder Bird may perform no further actions. Defensive Value drops to 5.
 - 3 — **Engines severely damaged.** Thunder Bird reduced to a Drive value of 1. Reduce Defensive Value by 7 due to additional damage.
 - 4 — **Datalink knocked out.** Thunder Bird may no longer benefit from scanning. Reduce Defensive Value by 6.
 - 5 — **Maneuver Thrusters damaged.** All turns, including Tight Turns, cost one extra movement point to perform.
 - 6 — **Shields damaged.** Reduce Defensive Value by 3.
 - 7 — **Targeters damaged.** Reduce chance To Hit and Lock-on by 4.
 - 8 — **Targeters damaged.** Weapons may not be fired until after the next game turn.
 - 9 — **Torp Load jettison.** Thunder Bird loses 1D4 remaining torps of the pilot's choice.
 - 10 — **Engines sputter.** Thunder Bird may only use 2 movement points next game turn. Reduce Defensive Value by 6 due to additional damage.
 - 11 — **Pilot dazed.** Thunder Bird may not move or fire until after the next game turn.
 - 12 — **Reactor hit.** Thunder Bird detonates and is destroyed.
- PULSE LASER SPECS**
- Short Range:** 1-3 hexes (+1 To Hit).
Medium Range: 4-9 hexes.
Long Range: 10 hexes (-1 To Hit).

GAME TURN RECORD TRACK

1	2	3	4	5	6	7	8	9	10	11	12	13	14	15	16	17	18	19	20
---	---	---	---	---	---	---	---	---	----	----	----	----	----	----	----	----	----	----	----

CONSOLIDATED MASTER WEAPON TABLE

Weapon Type	Base Attack Dice	Range Increments (To Hit Modifiers)			Target Speed Restrictions	Damage
		Short (+1)	Mid (0)	Long (-1)		
TERRAN WEAPONS						
<i>Mass Driver Cannons</i>						
Minigun	2D6+ADB	1-2	3-5	6-12	None	Low †
Autocannon	2D6+ADB	1-3	4-10	11-24	Drive ≤10	Medium †
Railrepeater	2D6+ADB	1-4	5-15	16-36	Drive ≤6	High †
<i>Laser Cannons</i>						
Pulse Laser	2D8+ADB	1-3	4-9	10	None	Low
Meld Laser	2D8+ADB	1-6	7-18	19-20	Drive ≤12	Medium
Turbo Laser	2D8+ADB	1-9	10-25	26-30	Drive ≤8	High
<i>Blast Cannons</i>						
Splattergun	2D6+ADB	1-2	3-6	7-10	None	Medium
Blatgun	2D6+ADB	1-4	5-10	11-15	Drive ≤13	High
<i>Disruptor Cannons</i>						
Disruptorgun	2D8+ADB	1	2	3-6	None	Medium §
Disintegrator	2D8+ADB	1	2-3	4-12	Drive ≤11	High §
<i>Ion Cannons</i>						
Impulsegun	2D8+ADB	1-3	4-8	9-10	None	High
Ion Ram	2D8+ADB	1-5	6-13	14-15	Drive ≤15	All
<i>Plasma Cannons</i>						
Plazgun	2D6+ADB	1-2	3-4	5-10	None	All ¥
Heavy Plazgun	2D6+ADB	1-4	5-8	9-15	Drive ≤11	All x 2 ¥
<i>Energy Bolt Projectors</i>						
Protobolt	2D6+ADB	5-8	9-12	13-16	Drive ≤14	s.10/m.8/l.6
<i>EMP Cannons</i>						
EMP Ray	2D8+ADB	1-2	3-4	5-8	None	Medium/2□
EMP Beam	2D8+ADB	1-3	4-6	7-15	Drive ≤14	High/2□
HATCHLING WEAPONS						
<i>Beam Cannons</i>						
X-Beam	2D8+ADB	1-3	4-14	15-16	None	Low x 3
Y-Beam	2D8+ADB	1-3	4-16	17-18	Drive ≤13	Medium x 2
Z-Beam	2D8+ADB	1-3	4-20	21-22	Drive ≤10	High x 2
<i>Leech Cannons</i>						
Drive Leech	2D6+ADB	1	2	3-4	None	Low ‡
<i>Launchers</i>						
Spore Mole	1D6	—	0-6*	—	None	Low Δ
<i>Warheads</i>						
Type 1 Drone	1D12	—	0-1◇	—	None	All
Type 2 Drone	2D12	—	0-2◇	—	None	All
Type 3 Drone	3D12	—	0-3◇	—	None	All
Type 4 Drone	4D12	—	0-4◇	—	None	All
Type 5 Drone	5D12	—	0-5◇	—	None	All

Notes

†—Whenever two of the attack dice roll doubles, multiply base damage delivered by 2.

§—If target's Defensive Value has not been reduced by a critical hit, add 1 to its Defensive Value. Also, completely ignore target's Damage Reduction when resolving a hit.

¥—If the attack dice roll triples, the weapon mount overloads and is destroyed. The target is not affected.

□—If the attack dice roll doubles or triples, the target takes an additional critical. Also, completely ignore target's Damage Reduction when resolving a hit.

*—A missile/spore mole target must be within 10/6 hex range only at the beginning of the Missile/Spore Mole Launch Phase.

‡—Low damage is distributed only to the target's Drive damage boxes, ignoring Damage Reduction value.

Δ—Low damage indicates the number of crewman killed in the target vessel. No hits are inflicted on the Damage Track.

◇—Hits within this range are automatic; there is no need to roll To Hit.

ALTERNATE RANGE EFFECTS TABLE

	Range Increments (To Hit Modifiers)					
	Point Blank +2	Short (+1)	Medium (0)	Long (-1)	Very Long (-2)	Extreme (-4)
TERRAN WEAPONS						
<i>Mass Driver Cannons</i>						
Minigun	1	2	3-5	6-10	11-12	—
Autocannon	1	2-3	4-10	11-20	21-22	23-24
Railrepeater	1	2-4	5-15	16-30	31-33	34-36
<i>Laser Cannons</i>						
Pulse Laser	1-2	3	4-8	9	10	—
Meld Laser	1	2-6	7-15	16-17	18-19	20
Turbo Laser	1	2-9	10-19	20-25	26-28	29-30
<i>Blast Cannons</i>						
Splattergun	1	2	3-4	5-6	7-10	—
Blatgun	1	2-4	5-7	8-10	11-13	14-15
<i>Disruptor Cannons</i>						
Disruptorgun	—	1	2	3-4	5-6	—
Disintegrator	—	1	2-3	4-6	7-12	—
<i>Ion Cannons</i>						
Impulsegun	1	2-3	4-6	7-8	9-10	—
Ion Ram	1	2-5	6-13	14	15	—
<i>Plasma Cannons</i>						
Plazgun	1	2	3-4	5-6	7-8	9-10
Heavy Plazgun	1	2-4	5-8	9-10	11-12	13-15
<i>Energy Bolt Projectors</i>						
Protobolt	—	5-8	9-12	13-16	—	—
HATCHLING WEAPONS						
<i>Beam Cannons</i>						
X-Beam	1	2-3	4-14	15	16	—
Y-Beam	1	2-3	4-16	17	18	—
Z-Beam	1	2-3	4-20	21	22	—
<i>Leech Cannons</i>						
Drive Leech	—	1	2	3	4	—

TPV

Tons: 1040

Type 1 Drones

Type 4 Drones

Special Equipment

Tow Hook

Drone Mover 4

Weapon 1 Z-Beam (F)
To Hit: 2D8+ADB
Damage: High x 2
Range: 3/20/22
Target SR ≤10

Weapon 2 Z-Beam (F)
To Hit: 2D8+ADB
Damage: High x 2
Range: 3/20/22
Target SR ≤10

Weapon 3 Z-Beam (F)
To Hit: 2D8+ADB
Damage: High x 2
Range: 3/20/22
Target SR ≤10

Jump Pods

2

2

2

3

3

4

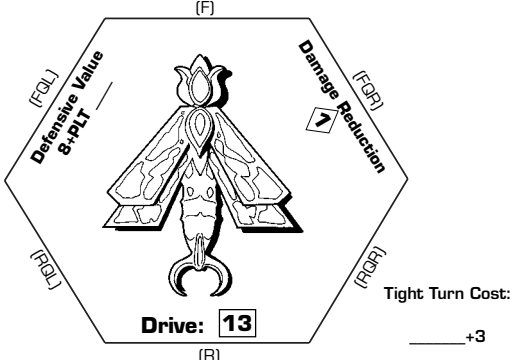

Weapon 4 X-Beam (360°)
To Hit: 2D8+ADB
Damage: Low x 3
Range: 3/14/16

Weapon 5 X-Beam (360°)
To Hit: 2D8+ADB
Damage: Low x 3
Range: 3/14/16

DAMAGE TRACK

→				D	●	13	*			w
	12	d	●	1	11		D	10		
		w	9	d	●	D	*	8		d
			7	w		D		6	●	
			5		d	*		4	D	w
				D	●			2	d	
					1	w	d	●		×

TPV

Tons: 1040

Type 1 Drones

Type 4 Drones

Special Equipment

Tow Hook

Drone Mover 4

Weapon 1 Z-Beam (F)
To Hit: 2D8+ADB
Damage: High x 2
Range: 3/20/22
Target SR ≤10

Weapon 2 Z-Beam (F)
To Hit: 2D8+ADB
Damage: High x 2
Range: 3/20/22
Target SR ≤10

Weapon 3 Z-Beam (F)
To Hit: 2D8+ADB
Damage: High x 2
Range: 3/20/22
Target SR ≤10

Jump Pods

2

2

2

3

3

4

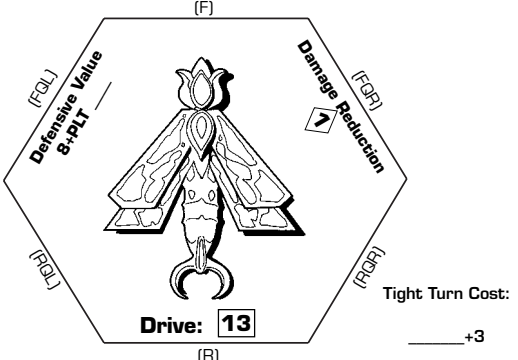

Weapon 4 X-Beam (360°)
To Hit: 2D8+ADB
Damage: Low x 3
Range: 3/14/16

Weapon 5 X-Beam (360°)
To Hit: 2D8+ADB
Damage: Low x 3
Range: 3/14/16

DAMAGE TRACK

→				D	●	13	*			w
	12	d	●	1	11		D	10		
		w	9	d	●	D	*	8		d
			7	w		D		6	●	
			5		d	*		4	D	w
				D	●			2	d	
					1	w	d	●		×

CRITICAL HITS

- 1 — Shields damaged. Reduce Defensive Value by 3.
- 2 — Hull cracks. Dragonfly takes 1D8 more damage.
- 3 — Beam power drops. Change damage to "Low" on one random X-Beam.
- 4 — Beam power short. Hatchling may not fire a beam weapon until after next game turn.
- 5 — Electronic Warfare Rig damaged. Dragonfly may no longer jam torps.
- 6 — Special Equipment shredded. Hatchling may no longer use Drone Mover or Tow Hook.
- 7 — Drone Mover seizures. When this Drone Mover is used, target drone has 2 in 4 chance of being destroyed.
- 8 — Drone Launcher damaged. Dragonfly takes 1D4 hits for each additional drone launched.
- 9 — Hatchling stunned. Dragonfly may take no further actions until after D4 turns.
- 10 — Hull snaps apart. The Dragonfly is destroyed.

X-BEAM SPECS

Short Range: 1-3 hexes (+1 To Hit).
Medium Range: 4-14 hexes.
Long Range: 15-16 hexes (-1 To Hit).

Z-BEAM SPECS

Short Range: 1-3 hexes (+1 To Hit).
Medium Range: 4-20 hexes.
Long Range: 21-22 hexes (-1 To Hit).
Target Speed Restriction: Target's Drive value must be ≤10.

LAMPREY

I.D.

BPV: 93

TPV

Tons: 670

Type 3 Drones

Weapon 1
Y-Beam (F)
 To Hit: 2D8+ADB
 Damage: Medium x 2
 Range: 3/16/18
 Target SR ≤13

Weapon 2
Drive Leech (F)
 To Hit: 2D6+ADB
 Damage: Low *
 Range: 1/2/4

Weapon 3
X-Beam (F) (R)
 To Hit: 2D8+ADB
 Damage: Low x 3
 Range: 3/14/16

Hatchling
 Plt: _____
WEAPON 1
 Gnr: _____
WEAPON 2
 Gnr: _____
WEAPON 3
 Gnr: _____

Jump Pods
 ②
 ③
 ④

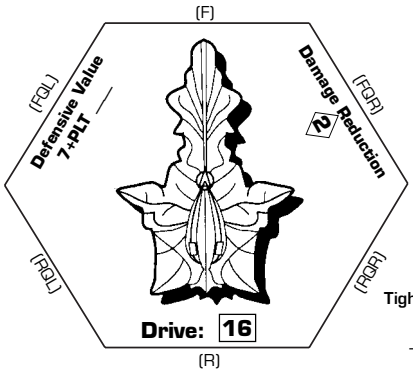

Special Equipment
 Grappling Tube
 Tow Hook

DAMAGE TRACK

→	d			16		d	w		15	●		
	d		14		*	●	13	W			d	
		12		②	11	*	d		10			
	w		9	①		7	5		3	2	1	×

GAME TURN RECORD TRACK

1	2	3	4	5	6	7	8	9	10	11	12	13	14	15	16	17	18	19	20
---	---	---	---	---	---	---	---	---	----	----	----	----	----	----	----	----	----	----	----

LAMPREY

I.D.

BPV: 93

TPV

Tons: 670

Type 3 Drones

Weapon 1
Y-Beam (F)
 To Hit: 2D8+ADB
 Damage: Medium x 2
 Range: 3/16/18
 Target SR ≤13

Weapon 2
Drive Leech (F)
 To Hit: 2D6+ADB
 Damage: Low *
 Range: 1/2/4

Weapon 3
X-Beam (F) (R)
 To Hit: 2D8+ADB
 Damage: Low x 3
 Range: 3/14/16

Hatchling
 Plt: _____
WEAPON 1
 Gnr: _____
WEAPON 2
 Gnr: _____
WEAPON 3
 Gnr: _____

Jump Pods
 ②
 ③
 ④

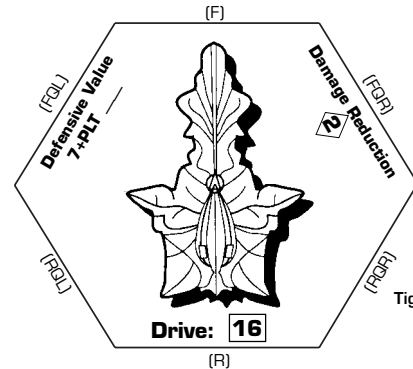

Special Equipment
 Grappling Tube
 Tow Hook

DAMAGE TRACK

→	d			16		d	w		15	●		
	d		14		*	●	13	W			d	
		12		②	11	*	d		10			
	w		9	①		7	5		3	2	1	×

CRITICAL HITS

- Shields damaged. Reduce Defensive Value by 1.
- Hull cracks. Lamprey takes 2D4 more hits.
- Tow Hook damaged. Mark off this piece of equipment.
- Drones destroyed. Lose all remaining drones.
- Electronic Warfare Rig damaged. Lamprey may no longer jam torps.
- Grappling Tube destroyed. Mark off this piece of equipment.
- Y-Beam power drops. Modify Damage code by -3.
- Drive Leech power duct damaged. Modify Damage code by -1.
- Hatchling killed. Lamprey may take no further actions. Defensive Value is reduced to 5.
- Attack guts through Lamprey. It is destroyed.

DRIVE LEECH SPECS

Short Range: 1 hex (+1 To Hit).
 Medium Range: 2 hexes.
 Long Range: 3-4 hexes (-1 To Hit).
 * Low Damage is distributed only to target's Drive Damage boxes, ignoring Damage Reduction value.

X-BEAM SPECS

Short Range: 1-3 hexes (+1 To Hit).
 Medium Range: 4-14 hexes.
 Long Range: 15-16 hexes (-1 To Hit).

Y-BEAM SPECS

Short Range: 1-3 hexes (+1 To Hit).
 Medium Range: 4-16 hexes.
 Long Range: 17-18 hexes (-1 To Hit).
 Target Speed Restriction: Target's Drive value must be ≤13.

LARVA

TPV

Weapon 1
X-Beam (F)
To Hit: 2D8+ADB
Damage: Low x 3
Range: 3/14/16

Hatchling
Plt: _____
WEAPON 1
Gnr: _____

Tons: 250

Type 1 Drones

Jump Pods
②
③
③
④

Special Equipment
 Drone Mover 2

Drive: 15

Tight Turn Cost: _____+3

DAMAGE TRACK

→

	d	15		d	14	●		13		12	
*	11	●	w	10	d	5	◇	1	●	2	×

LARVA

TPV

Weapon 1
X-Beam (F)
To Hit: 2D8+ADB
Damage: Low x 3
Range: 3/14/16

Hatchling
Plt: _____
WEAPON 1
Gnr: _____

Tons: 250

Type 1 Drones

Jump Pods
②
③
③
④

Special Equipment
 Drone Mover 2

Drive: 15

Tight Turn Cost: _____+3

DAMAGE TRACK

→

	d	15		d	14	●		13		12	
*	11	●	w	10	d	5	◇	1	●	2	×

- CRITICAL HITS**
- Shields damaged. Reduce Defensive Value by 2.
 - Hull fibers shredded. Take 1 extra hit.
 - Weapon power flow hindered. Change X-Beam Damage to Low.
 - Drone Dispenser damaged. Lose 1D6 of remaining drone.
 - Electronic Warfare Rig damaged. Larva may no longer jam torps.
 - Drone Mover destroyed. Mark off this piece of equipment.
 - Jump Pods malfunction. Larva may no longer use Jump Pods.
 - Hatchling Drive Link destroyed. Drive Value drops to 0. Defensive Value drops to 5.
 - Hatchling killed. Larva may take no further actions. Defensive Value drops to 5.
 - Catastrophic Hull breach. Larva is destroyed.

LARVA

TPV

Weapon 1
X-Beam (F)
To Hit: 2D8+ADB
Damage: Low x 3
Range: 3/14/16

Hatchling
Plt: _____
WEAPON 1
Gnr: _____

Tons: 250

Type 1 Drones

Jump Pods
②
③
③
④

Special Equipment
 Drone Mover 2

Drive: 15

Tight Turn Cost: _____+3

DAMAGE TRACK

→

	d	15		d	14	●		13		12	
*	11	●	w	10	d	5	◇	1	●	2	×

LARVA

TPV

Weapon 1
X-Beam (F)
To Hit: 2D8+ADB
Damage: Low x 3
Range: 3/14/16

Hatchling
Plt: _____
WEAPON 1
Gnr: _____

Tons: 250

Type 1 Drones

Jump Pods
②
③
③
④

Special Equipment
 Drone Mover 2

Drive: 15

Tight Turn Cost: _____+3

DAMAGE TRACK

→

	d	15		d	14	●		13		12	
*	11	●	w	10	d	5	◇	1	●	2	×

- X-BEAM SPECS**
- Short Range: 1-3 hexes (+1 To Hit).
Medium Range: 4-14 hexes.
Long Range: 15-16 hexes (-1 To Hit).

TPV

Tons: 770

Type 2 Drones

Type 4 Drones

Weapon 1 Y-Beam (F) To Hit: 2D8+ADB Damage: Medium x 2 Range: 3/16/18 Target SR ≤13

Weapon 2 Y-Beam (F) To Hit: 2D8+ADB Damage: Medium x 2 Range: 3/16/18 Target SR ≤13

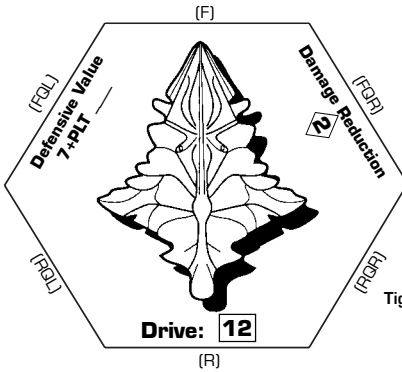

Jump Pads

Hatchling

Weapon 3 Spore Mole Launcher (360°) Lock-on < _____

Weapon 4 X-Beam (FQL) (RQL) (R) (RQR) (FQR) To Hit: 2D8+ADB Damage: Low x 3 Range: 3/14/16

Special Equipment

Ink Dispenser

DAMAGE TRACK

Damage track grid with numbers 1-12 and symbols.

TPV

Tons: 770

Type 2 Drones

Type 4 Drones

Weapon 1 Y-Beam (F) To Hit: 2D8+ADB Damage: Medium x 2 Range: 3/16/18 Target SR ≤13

Weapon 2 Y-Beam (F) To Hit: 2D8+ADB Damage: Medium x 2 Range: 3/16/18 Target SR ≤13

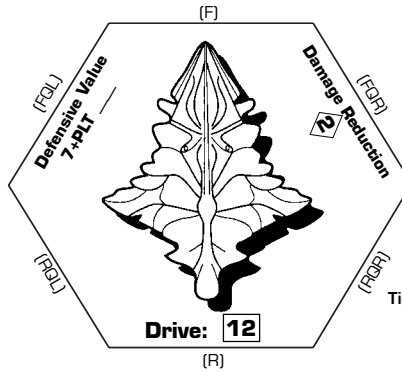

Jump Pads

Hatchling

Weapon 3 Spore Mole Launcher (360°) Lock-on < _____

Weapon 4 X-Beam (FQL) (RQL) (R) (RQR) (FQR) To Hit: 2D8+ADB Damage: Low x 3 Range: 3/14/16

Special Equipment

Ink Dispenser

DAMAGE TRACK

Damage track grid with numbers 1-12 and symbols.

CRITICAL HITS

- 1 - Shields damaged. Reduce Defensive Value by 1.
2 - Hull stressed. Manta takes 2D4 more hits.
3 - Tow Hook damaged. Mark off this piece of equipment.
4 - Massive Drone malfunction. Lose 1D4 of each remaining drone type.
5 - Electronic Warfare Rig Damaged. Manta may no longer jam torps.
6 - Drone Mover performance impeded. Reduce Drone Mover by 1 rating level.
7 - Ink Dispenser malfunctions. Mark off all remaining ink munitions.
8 - Spore Mole Launcher misfire. Lose 1D8 of remaining spore moles.
9 - Hatchling stunned. Manta may not move or fire until after next game turn.
10 - Catastrophic Hull collapse. Manta is destroyed.

X-BEAM SPECS

Short Range: 1-3 hexes (+1 To Hit).
Medium Range: 4-14 hexes.
Long Range: 15-16 hexes (-1 To Hit).

Y-BEAM SPECS

Short Range: 1-3 hexes (+1 To Hit).
Medium Range: 4-16 hexes.
Long Range: 17-18 hexes (-1 To Hit).
Target Speed Restriction: Target's Drive value must be ≤13.

MUCKWORM

I.D.

BPV: 63

TPV

Tons: 430

Type 2 Drones

Weapon 1
X-Beam (F)
 To Hit: 2D8+ADB
 Damage: Low x 3
 Range: 3/14/16

Weapon 2
X-Beam (360°)
 To Hit: 2D8+ADB
 Damage: Low x 3
 Range: 3/14/16

Ink Dispenser

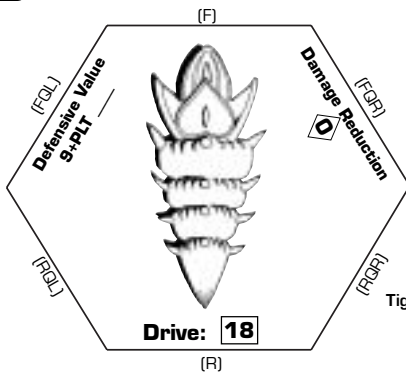

Hatchling
 Plt: _____
WEAPON 1
 Gnr: _____
WEAPON 2
 Gnr: _____
WEAPON 3
 Gnr: _____

Jump Pods

②
 ②
 ③
 ③

Weapon 3
Spore Mole Launcher (360°)
 Lock-on < _____

DAMAGE TRACK

→			18		17				d	15	*
			12	w	d	11	●	d			9
	●	d	w	8		d	7	*			6
	●	5	d	w	4	d		3	2	1	×

MUCKWORM

I.D.

BPV: 63

TPV

Tons: 430

Type 2 Drones

Weapon 1
X-Beam (F)
 To Hit: 2D8+ADB
 Damage: Low x 3
 Range: 3/14/16

Weapon 2
X-Beam (360°)
 To Hit: 2D8+ADB
 Damage: Low x 3
 Range: 3/14/16

Ink Dispenser

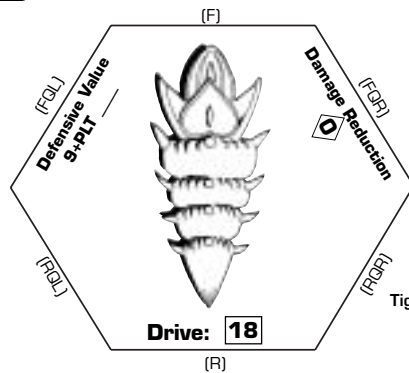

Hatchling
 Plt: _____
WEAPON 1
 Gnr: _____
WEAPON 2
 Gnr: _____
WEAPON 3
 Gnr: _____

Jump Pods

②
 ②
 ③
 ③

Weapon 3
Spore Mole Launcher (360°)
 Lock-on < _____

DAMAGE TRACK

→			18		17				d	15	*
			12	w	d	11	●	d			9
	●	d	w	8		d	7	*			6
	●	5	d	w	4	d		3	2	1	×

CRITICAL HITS

- Shields damaged. Reduce Defensive Value by 1D6.
- Hull Plates melt. Muckworm takes 1D4 more damage.
- Beam link damaged. Random X-Beam may not fire until after next game turn. Reduce damage for that X-Beam to Low x 2.
- Drone Launcher jammed. Muckworm takes 1D4 hits for each additional drone launched.
- Electronic Warfare Rig Damaged. Hatchling may no longer jam torps.
- Spore Moles triggered. Muckworm loses D4 Spores and takes the same amount of additional damage.
- Jump Pods fractured. Lose 1D4 of remaining jump pods of Hatchling's choice.
- Ink Dispenser collapse. Mark off all remaining ink munitions and dispenser.
- Hatchling killed. Muckworm may take no further actions. Defensive Value is reduced to 5.
- Hull disappears. The Muckworm is gone.

X-BEAM SPECS

Short Range: 1-3 hexes (+1 To Hit).
 Medium Range: 4-14 hexes.
 Long Range: 15-16 hexes (-1 To Hit).

GAME TURN RECORD TRACK

1	2	3	4	5	6	7	8	9	10	11	12	13	14	15	16	17	18	19	20
---	---	---	---	---	---	---	---	---	----	----	----	----	----	----	----	----	----	----	----

Universal Night Watch

© 1997 by Iron Crown Enterprises, Inc. Permission granted to photocopy for personal use.

MUSKELLUNGE

I.D. ■

BPV: 210

TPV

Tons: 1150

Type 1 Drones

○ ○
○ ○
○ ○
○ ○

Type 5 Drones

○ ○
○ ○
○ ○
○ ○

Weapon 1
Z-Beam (F)
To Hit: 2D8+ADB
Damage: High x 2
Range: 3/20/22
Target SR ≤10

Weapon 2
Y-Beam (F) (R)
To Hit: 2D8+ADB
Damage: Medium x 2
Range: 3/16/18
Target SR ≤13

Weapon 3
Y-Beam (FQL) (F)
To Hit: 2D8+ADB
Damage: Medium x 2
Range: 3/16/18
Target SR ≤13

Weapon 4
Y-Beam (F) (FQR)
To Hit: 2D8+ADB
Damage: Medium x 2
Range: 3/16/18
Target SR ≤13

Weapon 5
X-Beam (360°)
To Hit: 2D8+ADB
Damage: Low x 3
Range: 3/14/16

Ink Dispenser
○ ○

Special Equipment
 Tow Hook
 Drone Mover 5

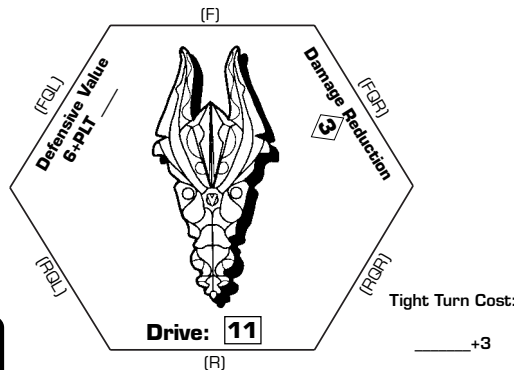

Hatchling
Plt: _____
WEAPON 1
Gnr: _____
WEAPON 2
Gnr: _____
WEAPON 3
Gnr: _____
WEAPON 4
Gnr: _____
WEAPON 5
Gnr: _____

Jump Pods
②
②
②
③
④

DAMAGE TRACK

→				3	d	w		11		●			D
		*				d			W				10
	●	d					D			D			w
			9						d		*		
				W		8			2		d		d
	●		d					7				*	
				6						D			5
	w		D	1		4			3			2	1
													×

CRITICAL HITS

- Hull fibers absorb damage. No effect.
- Hull cracks. Muskellunge takes 2D4 more damage.
- Tow Hook damaged. Mark off this piece of equipment.
- Drone Discharger temporarily jammed. Muskie may not lay drones until after next game turn.
- Electronic Warfare Rig damaged. Muskie may no longer jam torps.
- Drone Mover performance impeded. Reduce Drone Mover by 1 rating level.
- Hatchling Link to Z-Beam disrupted. Z-Beam may not fire until after next game turn.
- Power Routing to weapons disrupted. No Beam weapons may fire until after next game turn.
- Hatchling stunned. Muskie may not move or fire until after next game turn.
- Critical Hull breach. Take 5D10 more hits.

X-BEAM SPECS

Short Range: 1-3 hexes (+1 To Hit).
Medium Range: 4-14 hexes.
Long Range: 15-16 hexes (-1 To Hit).

Y-BEAM SPECS

Short Range: 1-3 hexes (+1 To Hit).
Medium Range: 4-16 hexes.
Long Range: 17-18 hexes (-1 To Hit).
Target Speed Restriction: Target's Drive value must be ≤13.

Z-BEAM SPECS

Short Range: 1-3 hexes (+1 To Hit).
Medium Range: 4-20 hexes.
Long Range: 21-22 hexes (-1 To Hit).
Target Speed Restriction: Target's Drive value must be ≤10.

REMORA

I.D. ■

BPV: 46

TPV

Tons: 370

Type 1 Drones

○ ○

○ ○

Weapon 1
X-Beam (F)
 To Hit: 2D8+ADB
 Damage: Low x 3
 Range: 3/14/16

Weapon 2
Drive Leech (F)
 To Hit: 2D6+ADB
 Damage: Low *
 Range: 1/2/4

○ ○ ○ ○

Hatchling
 Plt: _____
WEAPON 1
 Gnr: _____
WEAPON 2
 Gnr: _____

Jump Pods

②

③

④

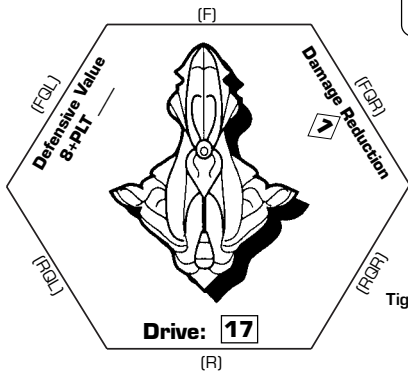

Tight Turn Cost: _____+3

Special Equipment

Grappling Tube

Tow Hook

DAMAGE TRACK

→		17	d		16	●	d	15		*		
	14	w		13		12	●	w	9	d	5	◇
	4	3	2	×								

REMORA

I.D. ■

BPV: 46

TPV

Tons: 370

Type 1 Drones

○ ○

○ ○

Weapon 1
X-Beam (F)
 To Hit: 2D8+ADB
 Damage: Low x 3
 Range: 3/14/16

Weapon 2
Drive Leech (F)
 To Hit: 2D6+ADB
 Damage: Low *
 Range: 1/2/4

○ ○ ○ ○

Hatchling
 Plt: _____
WEAPON 1
 Gnr: _____
WEAPON 2
 Gnr: _____

Jump Pods

②

③

④

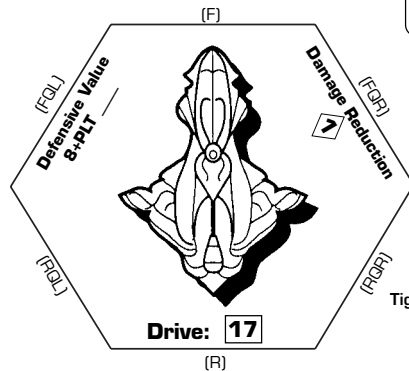

Tight Turn Cost: _____+3

Special Equipment

Grappling Tube

Tow Hook

DAMAGE TRACK

→		17	d		16	●	d	15		*		
	14	w		13		12	●	w	9	d	5	◇
	4	3	2	×								

CRITICAL HITS

- Shields damaged. Reduce Defensive Value by 2.
- Hull cracks. Remora takes 1D6 more hits.
- Tow Hook damaged. Mark off this piece of equipment.
- Drone Dispenser destroyed. Lose all remaining drones.
- Electronic Warfare Rig damaged. Remora may no longer jam torps.
- Grappling Tube destroyed. Mark off this piece of equipment.
- Jump Pod controls fused. Lose use of Jump Pods.
- Drive Leech power duct damaged. Modify Damage code to Low-1*.
- Hatchling killed. Remora may take no further actions. Defensive Value is reduced to 5.
- Blast snaps Structural Spine. Remora is destroyed.

DRIVE LEECH SPECS

Short Range: 1 hex (+1 To Hit).
 Medium Range: 2 hexes.
 Long Range: 3-4 hexes (-1 To Hit).
 * Low Damage is distributed only to target's Drive Damage boxes, ignoring Damage Reduction value.

X-BEAM SPECS

Short Range: 1-3 hexes (+1 To Hit).
 Medium Range: 4-14 hexes.
 Long Range: 15-16 hexes (-1 To Hit).

GAME TURN RECORD TRACK

1	2	3	4	5	6	7	8	9	10	11	12	13	14	15	16	17	18	19	20
---	---	---	---	---	---	---	---	---	----	----	----	----	----	----	----	----	----	----	----

SHAGGAI

I.D.

BPV: 39

TPV

Weapon 1 X-Beam (F) To Hit: 2D8+ADB Damage: Low x 3 Range: 3/14/16

Hatchling Plt: WEAPON 1 Gnr: WEAPON 2 Gnr:

Tons: 270

Type 1 Drones

Weapon 2 Spore Mole Launcher (360°) Lock-on <

Jump Pods

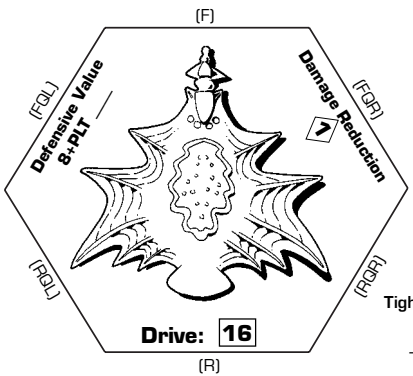

DAMAGE TRACK table with 16 cells containing numbers and symbols.

SHAGGAI

I.D.

BPV: 39

TPV

Weapon 1 X-Beam (F) To Hit: 2D8+ADB Damage: Low x 3 Range: 3/14/16

Hatchling Plt: WEAPON 1 Gnr: WEAPON 2 Gnr:

Tons: ???

Type 1 Drones

Weapon 2 Spore Mole Launcher (360°) Lock-on <

Jump Pods

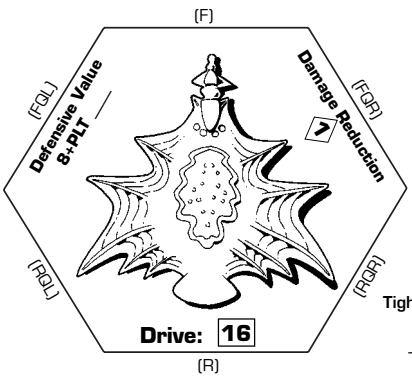

DAMAGE TRACK table with 16 cells containing numbers and symbols.

CRITICAL HITS

- 1 - Shields damaged. Reduce Defensive Value by 3.
2 - Hull Fibers shred. Shaggai takes 1D6 more damage.
3 - Jump pods fractured. Lose 1D4 of remaining jump pods of Hatchling's choice.
4 - Beam power drops. Change X-Beam damage to "Low."
5 - Electronic Warfare Rig Damaged. Hatchling may no longer jam torps.
6 - Drone Layer damaged. Shaggai may not lay Drones until after next game turn.
7 - Shaggai stunned. Shaggai may perform no actions until after next turn.
8 - Spore Moles triggered. Shaggai loses D4 Spores and takes the same amount of additional damage.
9 - Hatchling is killed. Shaggai may perform no further actions. Defensive Value is reduced to 5.
10 - Hull unravels. The Shaggai is destroyed.

X-BEAM SPECS

Short Range: 1-3 hexes (+1 To Hit).
Medium Range: 4-14 hexes.
Long Range: 15-16 hexes (-1 To Hit).

GAME TURN RECORD TRACK

Table with 20 numbered cells for game turn record.

SQUIDGE

I.D.

BPV: 90

TPV

Tons: 520

Weapon 1
Y-Beam (F)
 To Hit: 2D8+ADB
 Damage: Medium x 2
 Range: 3/16/18
 Target SR ≤13

Hatchling
 Plt: _____
WEAPON 1
 Gnr: _____
WEAPON 2
 Gnr: _____

Type 1 Drones
 ○ ○
 ○ ○
 ○ ○
 ○ ○

Weapon 2
X-Beam (360°)
 To Hit: 2D8+ADB
 Damage: Low x 3
 Range: 3/14/16

Jump Pods
 ②
 ②
 ③
 ③
 ④
 ④

Ink Dispenser
 ○ ○ ○ ○

Drive: **13**

Tight Turn Cost: _____+3

Special Equipment
 Drone Mover 3

DAMAGE TRACK

→	d	D		13	●	d	d		12	D		
●	d		*		11	d	●	w	②	10	D	
	9	d	*	●	7	w	①	5	4	3	2	×

SQUIDGE

I.D.

BPV: 90

TPV

Tons: 520

Weapon 1
Y-Beam (F)
 To Hit: 2D8+ADB
 Damage: Medium x 2
 Range: 3/16/18
 Target SR ≤13

Hatchling
 Plt: _____
WEAPON 1
 Gnr: _____
WEAPON 2
 Gnr: _____

Type 1 Drones
 ○ ○
 ○ ○
 ○ ○
 ○ ○

Weapon 2
X-Beam (360°)
 To Hit: 2D8+ADB
 Damage: Low x 3
 Range: 3/14/16

Jump Pods
 ②
 ②
 ③
 ③
 ④
 ④

Ink Dispenser
 ○ ○ ○ ○

Drive: **13**

Tight Turn Cost: _____+3

Special Equipment
 Drone Mover 3

DAMAGE TRACK

→	d	D		13	●	d	d		12	D		
●	d		*		11	d	●	w	②	10	D	
	9	d	*	●	7	w	①	5	4	3	2	×

CRITICAL HITS

- 1 — Shields damaged. Reduce Defensive Value by 1.
- 2 — Hull Fibers melted. Squidge takes 1D6 more damage.
- 3 — Hatchling link to X-Beam damaged. X-Beam may not fire until after next game turn.
- 4 — Drone Storage Bay rupture. Lose 1D4 of each remaining drone type. Roll separately.
- 5 — Electronic Warfare Rig Damaged. Squidge may no longer jam torps.
- 6 — Drone Mover performance impeded. Reduce Drone Mover by one rating level.
- 7 — Massive Jump Pod malfunction. Lose 1D4 of remaining Jump Pods. Hatchling's choice.
- 8 — Y-Beam power drops. Modify Damage code by -4.
- 9 — Hatchling killed. Squidge may take no further actions. Defensive Value is reduced to 5.
- 10 — Hull buckles under stress. Squidge is destroyed.

X-BEAM SPECS

Short Range: 1-3 hexes (+1 To Hit).
 Medium Range: 4-14 hexes.
 Long Range: 15-16 hexes (-1 To Hit).

Y-BEAM SPECS

Short Range: 1-3 hexes (+1 To Hit).
 Medium Range: 4-16 hexes.
 Long Range: 17-18 hexes (-1 To Hit).
 Target Speed Restriction: Target's Drive value must be ≤13.

GAME TURN RECORD TRACK

1	2	3	4	5	6	7	8	9	10	11	12	13	14	15	16	17	18	19	20
---	---	---	---	---	---	---	---	---	----	----	----	----	----	----	----	----	----	----	----

THISTLE

I.D.

BPV: 59

TPV

Tons: 360

Type 1 Drones

○ ○

○ ○

Type 2 Drones

○ ○

○ ○

Weapon 1
X-Beam (F)
 To Hit: 2D8+ADB
 Damage: Low x 3
 Range: 3/14/16

Weapon 2
X-Beam (360°)
 To Hit: 2D8+ADB
 Damage: Low x 3
 Range: 3/14/16

Ink Dispenser

○ ○ ○ ○ ○

Hatchling
 Plt: _____
WEAPON 1
 Gnr: _____
WEAPON 2
 Gnr: _____

Jump Pods

②

③

④

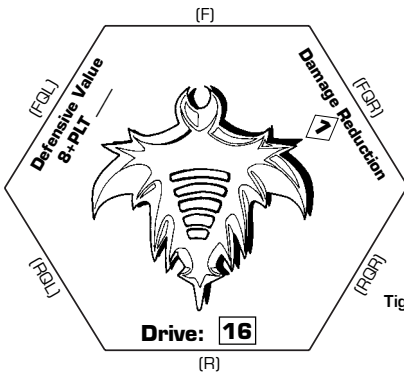

Tight Turn Cost: _____+3

DAMAGE TRACK

→	D	16	*	1	d	14	w	12	●	D	10
	d	8	●	D	6	d	*	5	D	4	
	3	w	●	2	1	d	×				

THISTLE

I.D.

BPV: 59

TPV

Tons: 360

Type 1 Drones

○ ○

○ ○

Type 2 Drones

○ ○

○ ○

Weapon 1
X-Beam (F)
 To Hit: 2D8+ADB
 Damage: Low x 3
 Range: 3/14/16

Weapon 2
X-Beam (360°)
 To Hit: 2D8+ADB
 Damage: Low x 3
 Range: 3/14/16

Ink Dispenser

○ ○ ○ ○ ○

Hatchling
 Plt: _____
WEAPON 1
 Gnr: _____
WEAPON 2
 Gnr: _____

Jump Pods

②

③

④

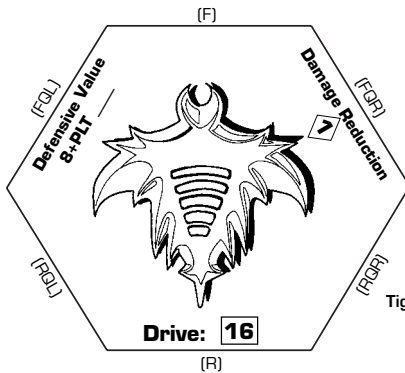

Tight Turn Cost: _____+3

DAMAGE TRACK

→	D	16	*	1	d	14	w	12	●	D	10
	d	8	●	D	6	d	*	5	D	4	
	3	w	●	2	1	d	×				

CRITICAL HITS

- Shields damaged. Reduce Defensive Value by 4.
- Hull Fibers melt. Thistle takes 2D4 more damage.
- Beam link damaged. Random X-Beam may not fire until after next game turn.
- Drone Launcher jammed. Take 1D4 hits for each additional drone launched.
- Electronic Warfare Rig Damaged. Hatchling may no longer jam torps.
- Beam power drops. Change damage to Low on random X-Beam.
- Jump Pods fractured. Lose 1D4 of remaining Jump Pods. Hatchling's choice.
- Ink Dispenser collapse. Mark off all remaining ink munitions and dispenser.
- Hatchling killed. Thistle may take no further actions. Defensive Value is reduced to 5.
- Hull disappears. The Thistle is gone.

X-BEAM SPECS

Short Range: 1-3 hexes (+1 To Hit).
 Medium Range: 4-14 hexes.
 Long Range: 15-16 hexes (-1 To Hit).

GAME TURN RECORD TRACK

1	2	3	4	5	6	7	8	9	10	11	12	13	14	15	16	17	18	19	20
---	---	---	---	---	---	---	---	---	----	----	----	----	----	----	----	----	----	----	----

VARTAK

I.D. ■

BPV: 83

TPV

Tons: 450

Weapon 1
X-Beam (F)
To Hit: 2D8+ADB
Damage: Low x 3
Range: 3/14/16

Ink Dispenser
○○○

Hatchling
Plt: _____
WEAPON 1
Gnr: _____
WEAPON 2
Gnr: _____

Type 2 Drones
○○
○○
○○
○○

Weapon 2
Spore Mole Launcher
(360°)
Lock-on < _____
○○○○○○○○○○○○○○○○○○○○

Jump Pods
②
②
③
③
④
④

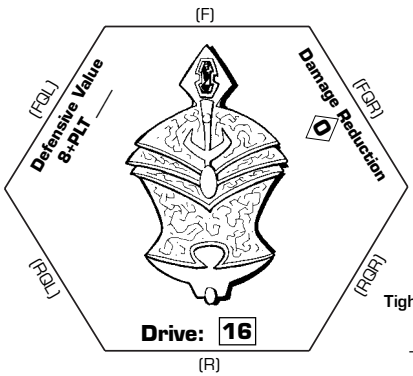

Tight Turn Cost: _____ +3

DAMAGE TRACK

		16	●	15	13	d	●		10	*
	d	●	9	w	●	d	8	●	d	6
d	4		d	*	3	d	w	2		×

VARTAK

I.D. ■

BPV: 83

TPV

Tons: 450

Weapon 1
X-Beam (F)
To Hit: 2D8+ADB
Damage: Low x 3
Range: 3/14/16

Ink Dispenser
○○○

Hatchling
Plt: _____
WEAPON 1
Gnr: _____
WEAPON 2
Gnr: _____

Type 2 Drones
○○
○○
○○
○○

Weapon 2
Spore Mole Launcher
(360°)
Lock-on < _____
○○○○○○○○○○○○○○○○○○○○

Jump Pods
②
②
③
③
④
④

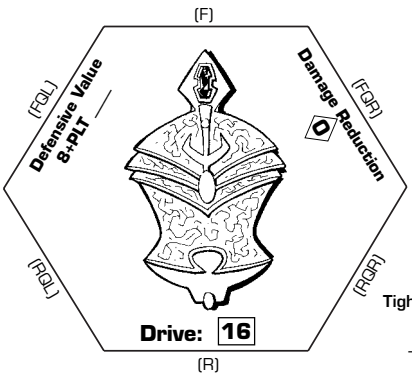

Tight Turn Cost: _____ +3

DAMAGE TRACK

		16	●	15	13	d	●		10	*
	d	●	9	w	●	d	8	●	d	6
d	4		d	*	3	d	w	2		×

CRITICAL HITS

- 1 — Shields damaged. Reduce Defensive Value by 1D4.
- 2 — Hull Fibers shred. Vartak takes 1D4 more damage.
- 3 — Jump pod fractured. Lose 1D4 of remaining jump pods of Hatchling's choice.
- 4 — Beam power drops. Change X-Beam damage to "Low."
- 5 — Electronic Warfare Rig Damaged. Hatchling may no longer jam torps.
- 6 — Drone Launcher hit. Remove 1D4 additional drones.
- 7 — Hatchling stunned. Vartak may perform no actions until after next turn.
- 8 — Spore Moles triggered. Vartak loses D4 Spores and takes the same amount of additional damage.
- 9 — Hatchling is killed. Vartak may perform no further actions.
- 10 — Hull shreds. The Vartak is destroyed.

X-BEAM SPECS

Short Range: 1-3 hexes (+1 To Hit).
 Medium Range: 4-14 hexes.
 Long Range: 15-16 hexes (-1 To Hit).

GAME TURN RECORD TRACK

1	2	3	4	5	6	7	8	9	10	11	12	13	14	15	16	17	18	19	20
---	---	---	---	---	---	---	---	---	----	----	----	----	----	----	----	----	----	----	----

Silent Death

New Weapon System Data Table

Weapon System	Cost	Slots	Base Attack Dice	Damage	Ammo
EMP Ray	3	1	2D8	Medium	∞
EMP Beam	5	4	2D8	High	∞
Tractor Beam*	5	5	—	—	N/A
Salvage Claw *	5	10	2D6	Medium	N/A
Tachyon Cannon	12	11	2D10	All	
Tachyon Ram	7	5	2D10	High	
Hammerhead 5	4	3	1D6/	High+1/	5
Hammerhead 10	5	3	1D6/	High+1/	10
Hammerhead 15	6	4	1D6/	High+1/	15
Hammerhead 20	7	4	1D6/	High+1/	20

* Pilot only.

Scanner Cost Table

Screen Rate							
Max. #	1-2	1-3	1-4	1-5	1-6	1-7	1-8
1	2-5(1)	3-5(1)	5-10(1)	10-10(1)	15-20(1)	20-20(1)	25-30(1)
2	3-5(2)	5-10(2)	10-10(2)	15-20(2)	20-20(2)	25-30(2)	30-30(2)
3	5-10(3)	10-10(3)	15-20(3)	20-20(3)	25-30(3)	30-30(3)	35-40(3)
4	10-10(4)	15-20(4)	20-20(4)	25-30(4)	30-30(4)	35-40(4)	40-40(4)
5	15-20(5)	20-20(5)	25-30(5)	30-30(5)	35-40(5)	40-40(5)	45-50(5)
6	20-20(6)	25-30(6)	30-30(6)	35-40(6)	40-40(6)	45-50(6)	50-50(6)

Enhanced Filtration System Cost Table

Value	Crew on Ship					
	1	2	3	4	5	6
1	1-1	2-1	3-2	4-2	5-3	6-4
2	3-1	6-2	8-3	10-4	12-5	15-6
3	8-2	10-3	13-4	17-6	21-7	26-8

The Standard Map Setup

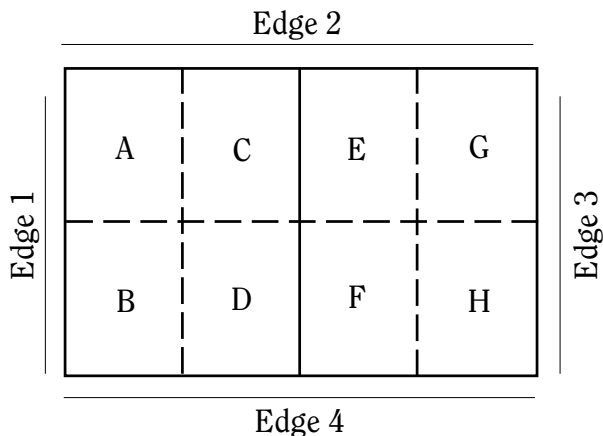

The Long Map Setup

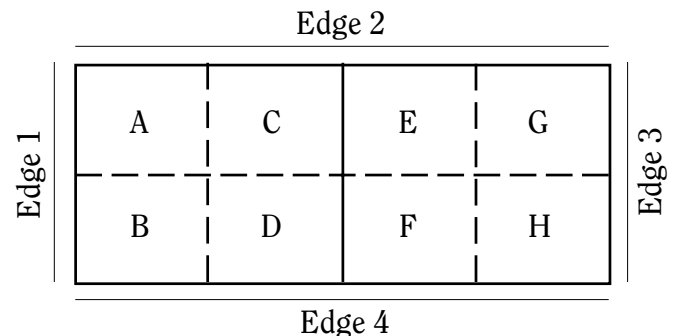

Universal Night Watch Turn Sequence

WARHEAD LAUNCH PHASE

Missile/Spore Mole lock-on attempts
Launch Missiles/Spore Moles
Launch Torpedoes

MOVEMENT PHASE

Make drive 0 turns
Move Scanner assisted DLT torps targeted
on stationary objects
Roll Initiative for Escorts
Move Escorts
Drift
Roll initiative
Starcraft movement:
Hatchlings deploy drones, attach Grappling
Tubes and Tow Claws during normal
movement
Torpedoes targeted at ships or other torps
move after target moves
Activate newly laid drones
Operate Drone Movers
Torpedoes fired at Drones move

TORPEDO RESULTS PHASE

Point Defense or Dodging attempts
Resolve torpedo attack
Deploy Decoy or attempt Jamming

CANNON FIRE PHASE

Gunners/Hatchlings fire in skill order
Pilots fire in skill order

MISSILE/SPORE MOLE RESULTS PHASE

Point Defense against Missiles/Spore Moles
Resolve Missiles/Spore Moles

END TURN PHASE

Asteroids drift
Resolve Grap Tube usage
Attempt Damage Control
Check for Ink Cloud dispersal (1 on a D6)

ELECTRONIC WARFARE PHASE

Designate targets and number of attempts
for scanning
Attempt scanning

Universal Night Watch Starcraft Point Cost Table

Starcraft	Basic Point Value	Crew
Thunder Bird NW	32	1
Night Hawk NW	49	1
Teal Hawk NW	50	2
Lance Electra NW	56	2
Firebat NW	57	2
Salamander NW	67	2
Rattler NW	70	2
Hornet NW	97	2
Epping NW	119	4
Equalizer NW	123	2
Javelin NW	131	3
Betafortress NW	160	3
Praying Mantis NW	167	3
Falcon NW	499	8

Brood Ships

Starcraft	Basic Point Value	# of Weapons
Larva	38	1
Shaggai	39	2
Remora	46	2
Thistle	59	2
Muckworm	63	3
Vartak	83	2
Squidge	90	2
Lamprey	93	3
Tiger Moth	120	5
Manta	136	4
Dragonfly	172	5
Muskellunge	210	5

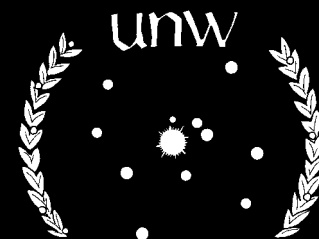

ferred their intelligence gathering skills to the organization rather than duplicating existing fighter wings.

Working with UNW scientists, the Hibernians designed and setup one of the most sophisticated information gathering networks in the galaxy. Since the other UNW members were naturally uncomfortable with an intelligence organization run by one of its own members, the network was placed under the control of the Central Command, and dubbed the "UNWIA." To ease the fears of other UNW members, the Hibernian intelligence officers responsible for organizing the UNW intelligence officially resigned their positions with Hibernian intelligence prior to working for the UNW. The network routinely tracks the movements of Grub Swarms in UNW space, and provides almost real time imagery to the CC during combat. The agency also provides detailed information about the size and composition of hibernating Grub Swarms.

ASP Technocracy

Self-confident to the point of arrogance, the ASP Technocracy joined the UNW program late in the game. The ASP look at participation in the UNW as a perfect opportunity to combat test new, innovative technological developments at someone else's expense. The ASP's close ties to the Draconians, however, made many UNW members hesitant to accept them into the UNW. To smooth their admission into the UNW, the ASPs graciously donated the technology of the Tachyon Cannon to the UNW. This action enabled them to squeak into the UNW with a bare majority vote. As it is, rumors persist that the Tachyon Cannons are really Draconian and not ASP technology. Nor has the mediocre quality of the ASP UNW units reassured the UNW about the ASPers' commitment to the UNW. To make matters worse, the ASP scientists have remained aloof from the UNW scientific branch, and have stated their preference for working independently. Their technological contributions to the

UNW have been sporadic at best. The ASP technocracy ranks in popularity with the Luches Utopia and House Colos. The ASPers' obsession with bioengineering and cybernetic implants has further alienated UNW members.

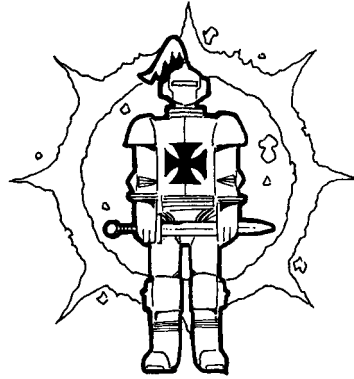

Data Sphere

CELESTIAL KNIGHTS

Commanding Officer: Upton Rashid

Terran paranoia towards the Data Sphere Artificial Intelligent (AI) life forms has guided Data Sphere political policies since before the First Grub-Terran War. The Data Sphere has worked hard to establish good relations with the rest of the Twelve. The Data Sphere is one of the earliest members of the Night Watch, and has been very active in the UNW's scientific and military branches. Unlike the ASP technocracy, the Data Sphere has been open and generous in sharing information and technology with the UNW. The fact that the Data Sphere has apparently begun to distance itself from the Draconians has also increased its popularity.

The Celestial Knights are among the best UNW units. The squadron is a mixture of AI and human pilots, since the Data Sphere is determined to break down the barriers of prejudice between humans and AI. The UNW has also begun to experiment with mixing humans and AIs in starcraft crews. The goal is to reap the benefit of the best of human and android. The experiment is still in its early stages, and it is too early to determine the effectiveness of these mixed crews. The Celestial Knights are popular with other UNW since they are easy to work with and are excellent team players.

The Next Millennium

flashed by above him. Excited chatter erupted over the radio as they dove down toward the Hatchling fighters.

"Claw 9 to Baby Bears, do you require my assistance?"

"Negative, Claw 9, get that crate back to the *Kodiak* before it self-destructs."

"Roger, Claw 9 out."

Kline would not normally have let such an insult to his ship pass, but he had more important things to consider. One was how to best spread his new found wealth to ensure a rapid promotion. The other was how to make Gratton's death look like an accident.

Leaving the fighting to his comrades, Kline accelerated away from Norvill V. Fifteen minutes later the *Kodiak* was in sight.

One last detail to attend to. Kline keyed another code into the fighter's console.

"I hope you know what you're doing, Gratton," he muttered.

The code activated a virus Gratton had inserted into the ship's

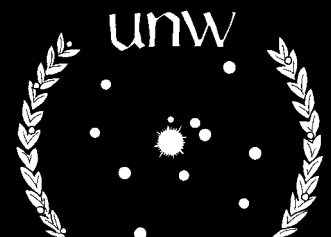

Silent Death

operating system. It would cause a massive electrical surge throughout the ship, burning out a number of systems, including the flight recorders. Without the recorder data, it would be impossible for anyone to reconstruct what had actually happened on this mission.

Five minutes passed. The *Kodiak* drew closer. In a few minutes Kline would have to begin his landing approach.

“Gratton, if this doesn’t work, both our butts are in a sling”

Kline stared at the instruments intently, as if he could cause something to happen through sheer force of will.

“Mama Bear to Claw 9, initiate landing procedures”

“Roger.”

Kline brought his Thunderbird around in a long slow arc behind the carrier and lined up on the ship’s stern.

“Claw 9, you’re in the pipe. ALC beacon is on.”

“Roger, activating ALC now.”

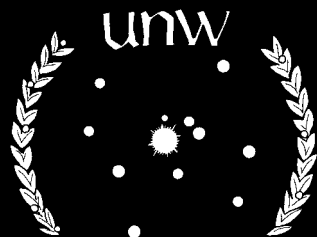

Squadron Summary

MACE SQUADRON

Squadron Leader:

Sandra Coltrain (Plt 10, Gnr 10)

Assets: 12 x Thunder Bird NW
8 x Firebat
4 x Rattler

DAGGER SQUADRON

Squadron Leader:

George Loundry (Plt 9, Gnr 10)

Assets: 6 x Teal Hawk NW
3 x Rattler
2 x Salamander NW
4 x Epping NW

AX SQUADRON

Squadron Leader:

Donny Red (Plt 9, Gnr 8)

Assets: 8 x Firebat
6 x Salamander NW
4 x Mantis

Unkulunkulu Archipelago

BLACK MAGIC

Commanding Officer: Joe Nader

After the success of Marley’s Military during the Grub wars, the Unkulunkulus decided to keep a strong military defense force. They did so primarily to discourage other powers from interfering in their affairs; the people of the Archipelago want, above all things, to be left alone. They are famous for their complete lack of interest in external politics. Grub-busting was never high priority with them however, since the Grubs were not a significant presence in their sector of space.

These attitudes changed (a little) when their retired President Marley was elected as head of the UNW council. In true Unkulunkulu tradition, they asked for vol-



unteers, and the first Archipelago Night Watch Squadrons were assembled and sent to Yoka-Shan to report for duty. Since the squadrons had no experience with Grub-busting, all of their training has been with other UNW units. The squadrons have thus far failed to distinguish themselves either in training or in action. As a result of their lackluster performance, they spend most of their time in the UNW barracks, or flying safe, routine escort missions.

Squadron Summary

VOODOO SQUADRON

Squadron Leader:

Lionel Mason (Plt 7, Gnr 8)

Assets: 10 x Thunder Bird NW
4 x Nighthawk NW
3 x Salamander NW

DREADLOCK SQUADRON

Squadron Leader:

Kelsi Batumzie (Plt 7, Gnr 8)

Assets: 6 x Nighthawk NW
2 x Mantis
6 x Teal Hawk NW
6 x Dart

Q’raj Void Protectorate

SWIFT JUSTICE

Commanding Officer: Lindar Khomeni

The Q’raj are among the best and most disciplined warriors in Terran space, and are fiercely loyal to their government. They are also among the most intelligent. Some say that these qualities are a result of natural selection, since the Q’raj have the dubious distinction of sharing a border with House Colos. Only the very strong and intelligent can survive in such a location.

When the Colosians and the Grubs retreated, the Q’raj were convinced that both would return. They reorganized their military and created special units dedicated to fighting Grubs, calling them the “Swift Justice.” Many of their best pilots were sent to Yoka-Shan for additional training. To keep in practice prior to the

foundation of the UNW, the Swift Justice regularly led forays into Grub infested space. This was the only way their pilots could get combat experience against the Grubs. The Grubs had learned their lesson about venturing into Q'raj space.

With the foundation of the UNW, the Swift Justice became the Protectorate's official UNW Wing.

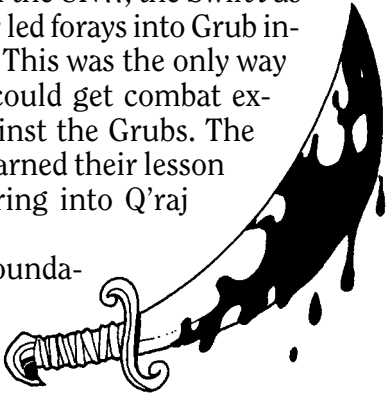

Squadron Summary

PHALANX SQUADRON

Squadron Leader:

Ahmeed Rachmed (Plt 10, Gnr 9)

Assets: 8 x Thunder Bird NW
4 x Salamander NW
2 x Death Wind

CRESCENT SQUADRON

Squadron Leader:

Areif Mundavy (Plt 9, Gnr 9)

Assets: 6 x Teal Hawk NW
4 x Rattler
2 x Equalizer
1 x Hornet

SCIMITAR SQUADRON

Squadron Leader:

Rasheed Abdul (Plt 8, Gnr 10)

Assets: 4 x Rattler
4 x Epping NW
4 x Thunder Bird NW



Luches Utopia

BLACK GRIZZLIES

Commanding Officer: Kevin Baret

The Night Watch wing of the Luches Utopia actually adopted its wing name after its first joint operation with the Night Watch wing of the Yoka-Shan Warworld. After annihilating the Grub Swarms, the Yoka-Shan crews conducting post battle sweeps of the combat zone reported that ships attacked by the Luches Utopian forces were "grizzly to look at." When the Utopian crews heard the report, they immediately adopted the name "Grizzlies."

The UNW has had some problems integrating the Luches Utopia wings into the UNW. While many of the Grizzlies are good pilots and gunners, they do not play well with others. The Luches wings tend to be obsessed with making kills, since this is how the Utopian government judges their performance. This approach frequently disrupts Night Watch operations, and the Grizzlies are unpopular with other UNW crews, who consider them unreliable.

Squadron Summary

FANG SQUADRON

Squadron Leader:

Doug Bertram (Plt 10, Gnr 9)

Assets: 4 x Firebat
2 x Salamander NW
2 x Epping NW

CLAW SQUADRON

Squadron Leader:

Bob Starr (Plt 9, Gnr 8)

Assets: 4 x Salamander NW
4 x Epping NW
6 x Thunder Bird NW

MAUL SQUADRON

Squadron Leader:

Kip Harris (Plt 8, Gnr 9)

Assets: 4 x Rattler
3 x Javelin
2 x Equalizer

The Next Millennium

The automated landing control system received telemetry data from the carrier's flight center and would guide the fighter down to a pinpoint landing.

"Gratton, if we make it through the court martial, you are going to die a slow and agonizing death."

The autopilot began firing the ship's thrusters, slowing its speed to match the carrier's. Kline quickly considered his options.

Only one choice, he thought, I'll have to fake a malfunction and pull away from the carrier. Hopefully that will give the virus time to kick in.

Kline flipped the switch to deactivate the ALC and pulled back hard on the stick.

The fighter did not respond; it continued to steadily close the distance to the carrier. Kline could now make out the *Kodiak's* operations center arching over the flight deck.

Kline tried again, with equal success.



Silent Death

"Ohh, Gratton, you are going to pay for this!"

Seconds before the fighter crossed the end of the flight deck, Kline was deafened by the wailing of alarms as a rainbow of warning lights lit the cockpit. Small tendrils of smoke curled out of the console.

"Nothing like cutting it close."

Unnoticed among the other lights, the ejection warning indicator blinked urgently.

"Maybe I'll buy you a beer before I..."

The firing of the Thunderbird's escape pod, just as it passed the threshold of the carrier's flight deck, cut Kline short. The pod rocketed clear of the fighter and slammed into the underside of the operations center, disintegrating on impact.

The fighter came down hard on the deck, buckling the landing gear, but was otherwise undamaged.

Fifteen minutes later, the intercom buzzed on the hangar deck.

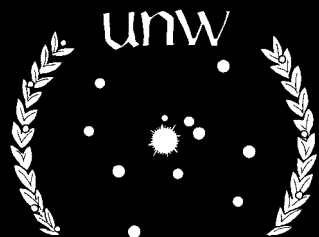

Basic Scenarios

"My center is giving way, my right retreats, situation excellent, I am attacking."

—Gen. Ferdinand Foch,
PreImp 1918

"We are surrounded by the Grubs. Today is a glorious day to kill Grubs."

—Unknown

All of the scenarios in this section use ships from Silent Death: The Next Millennium, Night Brood: First Contact, and the Universal Night Watch. The advanced sce-

narios include Escort class starcraft from Warhounds. The standard scenarios primarily use the basic rules, and the advanced scenarios incorporate optional rules. The scenarios depict a chronological order of significant Night Watch operations. Feel free to play them in any sequence as best fits your style.

The optional rule Drift is not used in any of these scenarios. Also, the optional rule Side slips is used as a standard rule in all scenarios.

Scenario 1: The Battle is Joined

"In combat, there is no limit to how bad things can get."

Date: AL 11:010

Location: Outer fringes of the Luches Utopia.

Situation: This scenario represents the battle occurred directly after Luches Utopia joined the UNW at Marley's request.

Forces

Elements of Zulu Squadron, Yoka-Shan Warworld: Setup second between 5 and 10 hexes from Edge 1 in area A.

Mantis A	Pilot (Plt 10; Gnr 7) Gunner A (Gnr 7) Gunner B (Gnr 8)
Firebat A	Pilot (Plt 7; Gnr 8) Gunner A (Gnr 6)
Hornet A	Pilot (Plt 8, Gnr 10) Copilot (Plt 5, Gnr 5)

Elements of Maul Squadron, Luches Utopia

Setup third within 2 hexes of Edge 1.

Equalizer A	Pilot (Plt 10, Gnr 8) Copilot (Plt 7, Gnr 9)
Javelin	Pilot (Plt 9, Gnr 5) Gunner A (Gnr 7) Gunner B (Gnr 10)
Rattler	Pilot (Plt 6, Gnr 5) Gunner A (Gnr 7)

Elements Chaos Critters (Swarm 1825)

Setup first along edge 3.

Squidge A	Pilot (Plt 6) Weapon A (Gnr 6) Weapon B (Gnr 8)
Manta A	Pilot (Plt 10) Weapon A (Gnr 9) Weapon B (Gnr 3) Weapon C (Gnr 7) Weapon D (Gnr 6)
Larva 1	Pilot (Plt 6, Gnr 5)
Larva 2	Pilot (Plt 5, Gnr 6)
Larva 3	Pilot (Plt 9, Gnr 9)
Larva 4	Pilot (Plt 5, Gnr 5)
Lamprey 1	Pilot (Plt 3) Weapon A (Gnr 2) Weapon B (Gnr 7) Weapon C (Gnr 9)

Victory Conditions

After 10 game turns, the Terrans must have killed all of the Grubs.

Battlefield Report

The joint tactics and cooperation paid off handsomely for the Terrans. The Grubs were caught unprepared and were completely destroyed.

Scenario 2: Anyone Out There?

“Just when you think it can’t get any worse, it does.”

—Ancient PreImp proverb

Date: AL 11:028

Location: Mining Planet Jonquil in ASP territory.

Situation: During a routine patrol, starcraft from the Data Sphere’s 438th Fighter Group discovered a Grub staging area in orbit around a moon of the mining planet Jonquil. The attack dispersed the Grubs, but several of the 438ths’ fighters were badly damaged. While these injured fighters limped back to base, a small force remained in place in case the Grubs returned. When the Grubs returned, the Data Sphere force put out a distress call. Reinforcements came from the Swift Justice wing of the Q’raj Protectorate.

Forces

Elements of Data Sphere’s 438th Squadron

Setup first in area A along Edge 1.

Thunder Bird A	Pilot (Plt 6; Gnr 7)
Thunder Bird B	Pilot (Plt 3, Gnr 3)

Elements of Escort Group Zulu

Setup second along Edge 2.

Larva 1	Pilot (Plt 5, Gnr 6)
Lamprey 1	Pilot (Plt 8)
	Weapon A (Gnr 7)
	Weapon B (Gnr 3)
	Weapon C (Gnr 6)
Remora 1	Pilot (Plt 6)
	Weapon A (Gnr 6)
	Weapon B (Gnr 9)

Elements of Phalanx Squadron, Q’raj Void Protectorate

Enter on turn 2 in area A along Edge 1.

Thunder Bird NW C	Pilot (Plt 8; Gnr 10)
Thunder Bird NW D	Pilot (Plt 8, Gnr 9)
Death Wind A	Pilot (Plt 7, Gnr 9)
	Gunner A (Gnr 10)

Victory Conditions

After 10 game turns, compare total point values. The side with the highest point value wins. In the event of a tie, the Terran player wins.

Battlefield Report

Once the Grubs appeared, the 438th covering force knew that they out gunned. The Data Sphere pilots were able to delay the Grub advance through some fancy flying, and the Night Watch arrived shortly after the battle began. The Grubs were destroyed after a brief fire fight, and the only Terran loss was a Thunder Bird from the 438th.

“Chief Gratton this is Commander Straun. We’ve got things squared away topside. We’ll be sending what’s left of Lt. Kline’s ship down to you shortly. Tear that thing apart, I want to know what happened out there.”

“Don’t worry, sir,” replied Gratton with a grin, “I plan to go over every inch of it with a fine-toothed comb.”

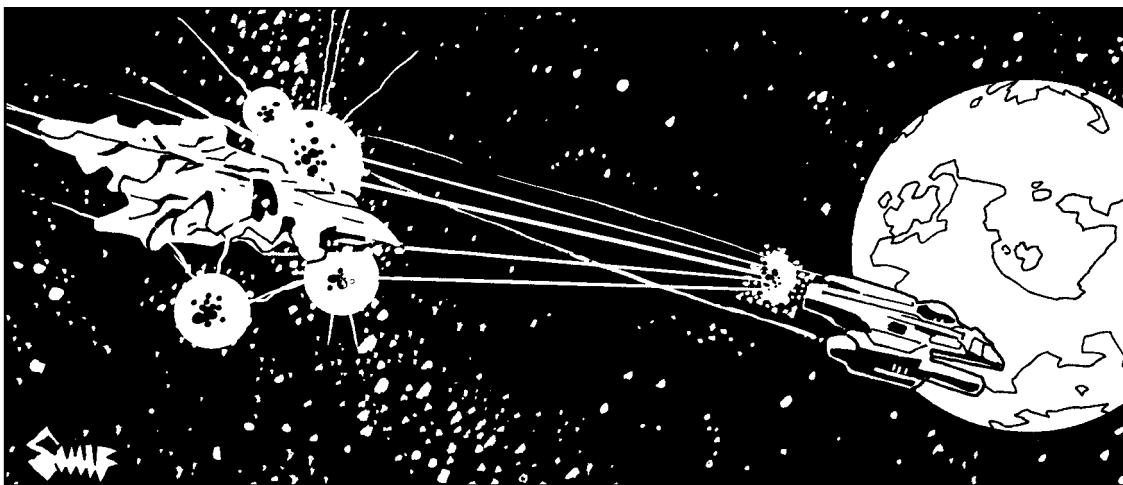

Silent Death

Excerpt from ASP
Technocracy report
#215: Operation Borg
...shows promise.

Unfortunately, Colonel Woodson experienced the same problems with sensory overload and overconfidence as the previous three subjects. We may need to develop some sort of electronic filter that reduces the system's signal strength. This may, of course, defeat the purpose of the system, which is to create a man-machine interface capable of replicating that of the Hatchlings.

Below is an annotated transcript of Colonel Woodson's mission recorder:

"I'm activating the interface harness now."

[A few seconds of silence.]

"I'm beginning to feel strangely detached, as if my body has gone to sleep and I'm floating above it. Now, I can feel a coldness around me, I feel as if I'm sinking into it. I can't move my arms or legs. Oh God, I'm drowning, I..."

Scenario 3: Recovery of Command

"I'd much rather be lucky than skillful."

—Hot shot pilot going into his second combat mission. There was no third mission.

Date: AL 11:037

Location: Outer reaches of former Imperial Core.

Situation: During a battle for control of Arnthor II, a Night Watch wing from House Red Star lost its Command Betafortress to the Grubs. The Grubs had made effective use of the dreaded Spore Moles to wipe out the crew of the TOC, the data link section, and the unfortunate pilot. The gunners, however, remained alive. The survivors of the battle dispatched a recovery force to retrieve the damaged Command Betafortress using a Teal Hawk that was crewed by two pilots. The second pilot would leave the Teal Hawk and enter the Betafortress and pilot the starcraft home. The Grubs, however, had different plans. The last intelligence reports provided by the UNWIA did not indicate the presence of any Grub units. This lack of intelligence led to another major set back for the Night Watch.

Forces

Elements of Mongol Squadron: Setup first where A, B, C, & D meet, facing toward map edge 2.

Command Betafortress (Pilot Dead)
Gunner A (Gnr 6)
Gunner B (Gnr 9)

Elements of Crescent Squadron

Setup second from Edge 4 in Area H.

Equalizer A Pilot (Plt 8, Gnr 10)
copilot (Plt 5, Gnr 9)
Teal Hawk NW Pilot (Plt 5, Gnr 8)
copilot (Plt 10, Gnr 9)
Thunder Bird NW A Pilot (Plt 9, Gnr 7)
Thunder Bird NW B Pilot (Plt 5, Gnr 10)

Elements of Swarm X39

Setup second along Edge 4 in Area B.

Larva 1 Pilot (Plt 6)
Weapon (Gnr 8)
Jump Pods 2 and 3 are used
Larva 2 Pilot (Plt 8)
Weapon (Gnr 8)
Jump Pods 3 and 4 are used
Lamprey 1 Pilot (Plt 5)
Weapon A (Gnr 5)
Weapon B (Gnr 9)
Weapon C (Gnr 5)
Jump Pods 2 and 4 are used
Remora 1 Pilot (Plt 9)
Weapon A (Gnr 9)
Weapon B (Gnr 7)
Jump Pod 3 is used
Manta 1 Pilot (Plt 5)
Weapon A (Gnr 4)
Weapon B (Gnr 7)
Weapon C (Gnr 7)
Weapon D (Gnr 9)
Jump Pods 3 and 3 are used

Optional Rules:

Asteroids, Auto Hits, Auto Misses, Damage Control, Time Limit.

Special Rules

- 1) Standard Map setup.
- 2) Asteroids in Area D and F scattered in an arc from the first hex of where Areas D and B meet on Edge 4, to two hexes away from the Command Betafortress toward Edge 4, to the first hex of where Area F and Area H meet on Edge 4.
- 3) On the first turn, no Terran starcraft may enter the asteroid field.
- 4) The Command Betafortress rotates 1 hex side per turn clockwise until the new pilot is in place, or a tow hook is in place.
- 5) The Grubs may not use Jump Pods on the first turn.
- 6) All Drones, Missiles, and Torpedo loads are at 50% (round down).
- 7) The Teal Hawk must remain stationary

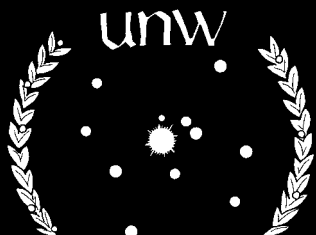

[More silence. Medical monitors show Woodson's heart rate has climbed to 120 beats per minute.]

"The sensation has passed. It's beautiful out here, the stars are all around me. I feel as if I'm flying, just like in a dream. Such freedom, I just think and I go. I love it.

[At this point Colonel Woodson's Hellbender performed a number of high-G maneuvers.]

"Huh? What's that? Oh, right. I'm now proceeding toward the mission operation area. You know, you guys should try this sometime, it's a real blast."

[Ten minutes later. Woodson's escorts report enemy contact.]

"Here come our friends out to play. Looks like four Shaggais by my count. You guys stay here. I'm gonna make a pass at them.

"Looks like I caught 'em off guard. Don't think they expected a single fighter to be so aggressive.



for 1 complete turn adjacent to the Command Betafortress in order for the replacement Pilot to eject.

- 8) The pilot transfer is complete 1 turn after the Teal Hawk is in position, i.e., if on turn 2 the Teal Hawk remains stationary, the pilot transfer is complete on turn 4. This means that the Betafortress can move under its own power.

Victory Conditions

Beta Escapes Edge: 3 Terran Victory

Beta Towed off Edge 1 by Grubs: Grub victory

After 10 game turns, if neither of the above has occurred, compare victory points. The side with the most points wins.

Beta Killed: -25 Terran

Teal Hawk Killed prior to replacement pilot ejecting: +100 Grub

Each ship killed: TPV

Battlefield Report

The Night Watch was caught completely unprepared. The Beta was captured by the Grubs while a small portion of the once proud Crescent squadron escaped total destruction.

Scenario 4: Pay Back!

"In war, you run short of everything, except the dead. You will always have plenty."

—Admiral B. Kolowski,
PreImp

Date: AL 11:038

Location: Outer reaches of former Imperial Core.

Situation: After the dismal performance of the Mongol and Crescent Night Watch squadrons in the recovery of the Command Betafortress, Central Command wanted a morale boost for the Universal Night Watch. Two strike teams were diverted from their missions and sent to destroy or recover the lost Command Betafortress.

Forces

Elements of Recovery Group Epsilon 4

Setup first within 3 hexes of Edge 1.

Larva 1	Pilot (Plt 9, Gnr 10)
Larva 2	Pilot (Plt 5, Gnr 8)
Larva 3	Pilot (Plt 8, Gnr 8)
Lamprey 1	Pilot (Plt 7) Weapon A (Gnr 9) Weapon B (Gnr 5) Weapon C (Gnr 6)
Squidge 1	Pilot (Plt 10) Weapon A (Gnr 7) Weapon B (Gnr 8)
Manta A	Pilot (Plt 7) Weapon A (Gnr 4) Weapon B (Gnr 7) Weapon C (Gnr 8) Weapon D (Gnr 5)

Elements of Krishna Squadron

Enter anywhere along Edge 2, 3, or 4 in Areas E, F, G, or H after all of the Grub ships have moved.

Mantis	Pilot (Plt 10, Gnr 9) Gunner A (Gnr 9) Gunner B (Gnr 9)
Firebat A	Pilot (Plt 9; Gnr 10) Gunner A (Gnr 10)
Firebat B	Pilot (Plt 9, Gnr 6) Gunner A (Gnr 5)
Rattler A	Pilot (Plt 6, Gnr 7) Gunner A (Gnr 9)

Reinforcements

A modified Shuttle with a Terran tow hook arrives anytime after turn 5 anywhere in Areas E, F, G, or H.

Shuttle	Pilot (Plt 10, Gnr 8) Gunner A (Gnr 9)
---------	---

Special Rules

- 1) The Terrans have initiative for the first round.
- 2) The Rear Damage Track of the Beta has damage up to and including the first critical hit.
- 3) There is no living crew on the Command Betafortress.
- 4) Use the Long map setup.
- 5) The Beta is being towed by the Lamprey and is placed immediately behind the Lamprey during setup.

Silent Death

“Dropping drones are we? We’ll see about that. Oh man, what a rush! I just cut a path through their drones with my lasers, barely had to break a sweat.

What a feeling of power. “Got one in front of me, engaging with autocannons. Yeeha! Hosed him down good. He won’t be reporting back to Mama Grub.

“Damn. They hit their jump pods and opened the range. Giving chase.”

[Colonel Woodson pursued the remaining Hatchling vessels and destroyed two of them in less than 20 seconds. The third was able to outdistance the Colonel’s Hellbender and escape by using its jump pods.]

“Let’s get that last one guys. What the hell do you mean, ‘return to base?’ We can’t let him escape. Besides I could take on an entire Grub fleet in this baby.

“No, by God, the operation is not concluded. I am going to go mix it up with some more Grubs and you are going to help. This

Victory Conditions

All of the Grubs destroyed within 10 game turns. Complete Terran victory.

Shuttle tows the Beta off Edge 3 within 10 game turns. Complete Terran victory.

Manta and Lamprey are destroyed in 10 game turns. Partial Terran victory.

Any other outcome results in a Grub victory.

Battlefield Report

The Terrans came in with a vengeance, and a vicious dogfight followed. In a hurry to retrieve the Betafortress, the Night Watch called for the recovery shuttle too early, and the recovery shuttle was unable to survive the attack of the Grubs’ Y-Beams and failed to connect with the Beta. Eventually, all of the remaining Grubs were destroyed and a replacement recovery shuttle was dispatched. Although costly, the Night Watch had regained the Command Betafortress.

Scenario 5: Action Over Marathon III

Date: AL 11:045

Location: Somewhere in the former Imperial Core.

Situation: During the opening moves of a Night Watch’s cleansing mission, elements of Goblin Squadron ambushed a Grub Command flight returning from a raid of an undefended mining facility. The new Mantis, built specifically for the Night Watch, saw its most glorious combat action. The Grubs were caught unaware of the incoming Night Watch.

Squidge A	Pilot (Plt 6) Weapon A (Gnr 7) Weapon B (Gnr 8)
Squidge B	Pilot (Plt 5) Weapon A (Gnr 6) Weapon B (Gnr 7)
Squidge C	Pilot (Plt 5) Weapon A (Gnr 6) Weapon B (Gnr 5)
Squidge D	Pilot (Gnr 4) Weapon A (Gnr 5) Weapon B (Gnr 4)

Forces

Elements of Goblin Squadron

Setup off the board after the Grub player has placed all ships.

Beta A	Pilot (Plt 8; Gnr 7) Gunner A (Gnr 10) Gunner B (Gnr 9) Gunner C (Gnr 8) Gunner D (Gnr 7) Gunner E (Gnr 6)
Mantis A	Pilot (Plt 10; Gnr 9) Gunner A (Gnr 8) Gunner B (Gnr 9)
Nighthawk NW A	Pilot (Plt 8; Gnr 8)
Nighthawk NW B	Pilot (Plt 7; Gnr 8)
Nighthawk NW C	Pilot (Plt 7; Gnr 7)
Nighthawk NW D	Pilot (Plt 6; Gnr 7)

Elements of Marathon III Swarm

Setup first along edge 1.

Muskellunge A	Pilot (Plt 10) Weapon A (Gnr 4) Weapon B (Gnr 5) Weapon C (Gnr 6) Weapon D (Gnr 6) Weapon E (Gnr 9)
---------------	--

Special Rules

- 1) Each Grub ship has used all of the type 4 Jump Pods as a result of the raid. These circles begin the game marked out.
- 2) The Muskellunge has used its type 3 Jump Pods.
- 3) Use the Long Map Setup.
- 4) Grubs may not use Jump Pods on Turn 1.
- 5) Terran player enters the map from areas A, B, C, or D after all of the Grubs have moved.

Victory Conditions

The Goblins must destroy the Muskellunge. The Grubs win if the Muskellunge escapes off edge 3 by the end of 6 turns. If the Terran player is able to destroy the Muskellunge and 2 Squidges, the Terrans win. All other results mean a Grub victory.

Battlefield Report

The Goblins unmercifully attacked the Grubs and carried the day. They lost two Nighthawks due to their overzealous pursuit of the escaping Squidges.

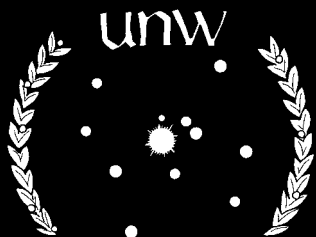

Scenario 6 : Capture the Comm Sat

“The greatest happiness is to scatter your enemy and drive him before you. To see his cities reduced to ashes. To see those who love him shrouded in tears.”

—Genghis Khan,
PreImp 1226

Date: AL 11:059

Location: Outer limits of House Colos and the Q’raj void Protectorate.

Situation: A Grub Swarm slipped into the region during the final hours of a UNW cleansing operation, hoping to use the battle as cover. The Swarm had two goals; the first was to capture of a Q’raj communications satellite to study new Terran communication and defensive technology. The second was to blind the defenders of the region to yet another oncoming swarm. Elements of Task Force Omnicrom were scrambled to intercept the advance elements of the swarm in Q’raj space. Col. Aubrey SantaCruz, commander of the task force, upon seeing the oncoming swarm, was quoted as saying “There will be a lot of letters written home after this one.”

Forces

Elements of Task Force Omnicrom

Setup first within 3 hexes of Edge 1.

Salamander NW 1	Pilot (Plt 6, Gnr 10) Gunner A (Gnr 10)
Salamander NW 2	Pilot (Plt 7 Gnr 6) Gunner A (Gnr 7)
Salamander 3	Pilot (Plt 4, Gnr 2) Gunner A (Gnr 1)
Hornet 1 NW	Pilot (Plt 7, Gnr 8) Gunner A (Gnr 5) Gunner B (Gnr 6)
Pit Viper 1	Pilot (Plt 5, Gnr 4)
Pit Viper 2	Pilot (Plt 6, Gnr 4)
Lance Electra 1	Pilot (Plt 1, Gnr 7) Gunner A (Gnr 4)

Elements of Swarm Delta-49

Setup second within 3 hexes of Edge 3.

Larva 1	Pilot (Plt 6) Weapon A (Gnr 5)
Larva 2	Pilot (Plt 8) Weapon A (Gnr 7)
Larva 3	Pilot (Plt 7)

Squidge 1

Weapon A (Gnr 4)
Pilot (Plt 10)

Squidge 2

Weapon A (Gnr 4)
Weapon B (Gnr 10)
Pilot (Plt 2)

Lamprey 1

Weapon A (Gnr 10)
Weapon B (Gnr 4)
Pilot (Plt 3)

Manta 1

Weapon A (Gnr 2)
Weapon B (Gnr 4)
Weapon C (Gnr 9)
Pilot (Plt 10)
Weapon A (Gnr 8)
Weapon B (Gnr 7)
Weapon C (Gnr 10)
Weapon D (Gnr 9)

Special Rules

- 1) Grubs must have 1 ship on the Comm Sat for 1 complete turn to capture it. Only the Manta or Lamprey can capture the Comm Sat.
- 2) Grubs must exit Edge 3 with Comm Sat.
- 3) Terran player places Comm Sat within 3 hexes of Edge 1 after all ships are placed.
- 4) There are NO other optional rules.

Victory Conditions

The Grubs must capture the satellite and escape off of Edge 3 by the end of Game Turn 10. Award points as follows:

Capture of Comm Sat: + 50 Grub points.

Destruction of Comm Sat: +20 Grub points.

If the Comm Sat is not destroyed or captured: +50 Terran points.

Grubs get 1 point per TPV for each Terran ship destroyed.

Terrans get 5 points per TPV for each Grub ship destroyed.

At the end of Game Turn 10, the side with the most points wins.

Battlefield Report

It was a sad day for the Night Watch. The Grubs attacked with new tactics which neutralized the Night Watch units. With the Comm Sat captured, the Grubs were able to open the doors to enter Q’raj space and obtained vital technology data.

operation is not concluded until I say it’s concluded.

“Return to base or be destroyed? Did you see what I just did? You get in my way son, and they’ll need an electron microscope to study what’s left of you.

“You’ve got five seconds to get that targeting radar off of me or I’m gonna come over there and shove that sensor array where the sun don’t shine. Okay, I warned you...”

[At 37.3 minutes into the mission, Colonel Woodson opened fire on his escorts. His ship was immediately destroyed by remote detonation.]

As you can see, the improved interface performs as expected. The limiting factor to the successful deployment of such a system seems to be the human element. Obviously, we need to subject future candidates to a more rigorous psychiatric screening. Unfortunately, with the loss of four pilots to date, it may be difficult to find further volunteers for this program...



Silent Death

Strange Bedfellows

"We're doing what?"
"You heard me.
We've been assigned to fly escort for the uThulwani Brigade."

"You have got to be kidding. Those are the Yoko-Shani bastards that took out our base on Centel IV a year and a half ago. I had friends there. Hell, we all did."

"Look, I requested a new assignment. My request was denied. The liberation of Shiva is a big operation and every available resource UNW has, is being used. We're just gonna have to get along."

Decker looked at his wing leader, Lars Venke, in amazement.

"You mean you don't want some payback for what they did?"

"I didn't say that," replied Venke, "All I know is that the brass I spoke to made it very clear that there will be no friendly fire incidents. You got that? Something like that would have serious political repercussions."

"More importantly, the uThulwani are

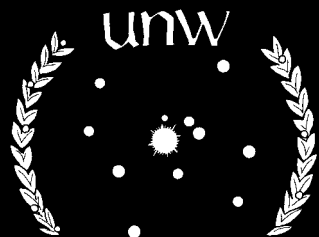

Scenario 7: All or Nothing

"If at first you don't succeed, change the rules."

—Excerpt from Colosian training manual.

Date: AL 11:068

Location: Mining Planet Jonquil in ASP territory.

Situation: While most of Red Star's UNW wings were engaged in a fierce battle with one of the largest swarms seen to date, another swarm appeared on the horizon, and the outnumbered Terrans called for reinforcements. CentComm was already in motion and dispatched task force Delta 99. Due to the location of the task force, their approach to the combat area brought them head on into the battle with the new Grub swarm.

Forces

Elements of Swarm Theta 6

Enter on Edge 1.

Larva 1	Pilot (Plt 8, Gnr 9)
Larva 2	Pilot (Plt 5, Gnr 6)
Larva 3	Pilot (Plt 10, Gnr 6)
Larva 4	Pilot (Plt 6, Gnr 8)
Larva 5	Pilot (Plt 10, Gnr 8)
Larva 6	Pilot (Plt 7, Gnr 8)
Larva 7	Pilot (Plt 9, Gnr 8)
Larva 8	Pilot (Plt 10, Gnr 4)
Squidge 1	Pilot (Plt 8) Weapon A (Gnr 6) Weapon B (Gnr 8)

Elements of Task Force Delta

Enter on Edge 3.

Firebat A	Pilot (Plt 8; Gnr 8) Gunner A (Gnr 8)
Firebat B	Pilot (Plt 10, Gnr 6) Gunner A (Gnr 8)
Firebat C	Pilot (Plt 6, Gnr 10) Gunner A (Gnr 10)
Hornet A	Pilot (Plt 5, Gnr 9) copilot (Plt 5, Gnr 6)
Epping NW	Pilot (Plt 10, Gnr 9) Gunner A (Gnr 9) Gunner B (Gnr 9) Gunner C (Gnr 9)

Special Rules

- 1) Use the Standard map setup.
- 2) Place 17 Asteroid counters in a belt pattern from Edge 4 to Edge 2 in the center of the playing area.

Victory Conditions

After 10 game turns, the side that has killed the most TPV wins.

Battlefield Report

After one of the longest battles in UNW history, the outnumbered Night Watch units were completely destroyed. The Grubs were able to field a single Larva that could barely move under its own power.



Scenario 8: New Foes

“War with the Grubs is like nothing humanity has ever seen.”

—Rear Admiral Percy Pershing, Commander of the Kashmere Task Force Delta, AL 10

Date: AL 11:088

Location: The outer fringe of the old imperial core near the Kashmere Commonwealth.

Situation: While on a routine patrol, elements of Gurkha and Brahma squadrons from the Kashmere Commonwealth engaged two previously unknown Grub ships.

Forces

Elements of Swarm Zeta 1

Setup first on Edge 1.

Muckworm A	Pilot (Plt 9) Weapon A (Gnr 4) Weapon B (Gnr 7) Weapon C (Gnr 6)
Muckworm B	Pilot (Plt 5) Weapon A (Gnr 6) Weapon B (Gnr 3) Weapon C (Gnr 8)
Vartak A	Pilot (Plt 7) Weapon A (Gnr 7) Weapon B (Gnr 8)
Vartak B	Pilot (Plt 4) Weapon A (Gnr 6) Weapon B (Gnr 5)

Elements of Gurkha Squadron, Kashmere Commonwealth

Enter second on Edge 3.

Firebat A	Pilot (Plt 10; Gnr 6) Gunner A (Gnr 9)
Rattler A	Pilot (Plt 7, Gnr 6) Gunner A (Gnr 9)

Elements of Brahma Squadron, Kashmere Commonwealth

Enter third on Edge 3.

Equalizer Pilot	(Plt 9, Gnr 8)
Co-pilot	(Plt 8, Gnr 8)

Special Rules

- 1) Use the Standard map setup.

Victory Conditions

After 10 game turns, the side with the most starcraft with drive and at least 1 crew wins.

Battlefield Report

At first sight, the new Grub ships seemed small and almost harmless. When the fighting ended, only the copilot of the severely damaged Equalizer was able to provide an account of the battle. News of the new Grub fighters spread quickly throughout the Night Watch. New tactics and training were developed, and existing crews warned about these new threats. The UNW had to act fast

in order to minimize the impact these new Grub ships could have to the Night Watch.

going to be the first grunts to hit the ground. If they don't secure the initial landing zones, there are a lot of House Colos troops in the second wave that won't make it home.”

“I still don't like it,” whined Decker, “The Crimson Guard nurse-maiding a bunch of Warworlder mercs, Centcom's crazy.”

“Well like it or not, you better get used to the idea. The op is in two days.”

Two days later, Decker liked the idea even less. From talking with the others, he knew that a good portion of the squadron felt the same way.

Slightly over eighteen months before, Decker and his comrades had been involved in an operation in the Centel system. A group of refugees from the Frontier were squatting on what had been House Colos territory before the Grub war. When the Colosians arrived to reclaim it, the squatters refused to leave. Decker's squad-

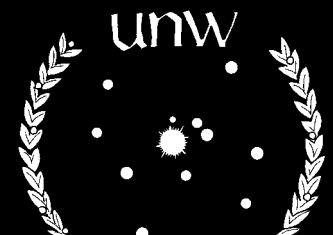
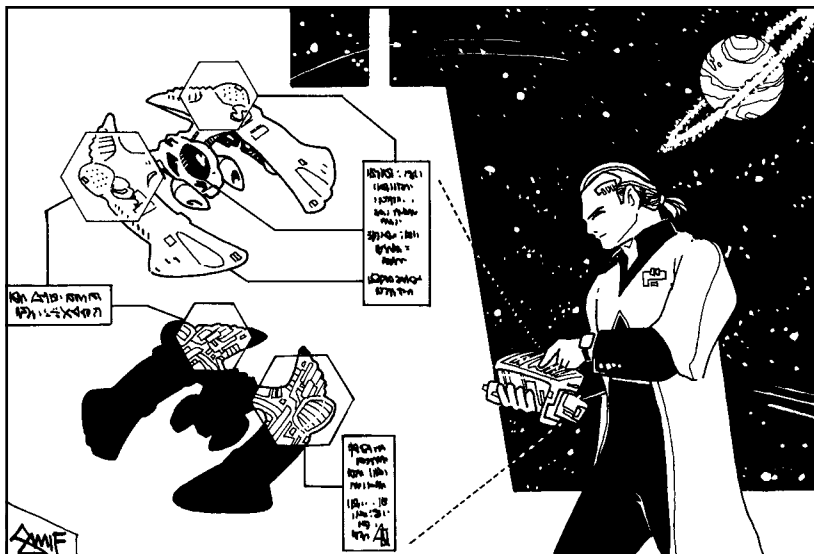

Silent Death

ron, the Crimson Death, was brought in to show them the error of their ways.

Unknown to the Colosians, the refugees had hired the uThulwani Brigade to help them defend their homes. One day, while most of the squadron was out on a strike mission, the Warworlders slipped into the system and struck the Colosian base. In less than thirty minutes, the base was

Scenario 9: Gates of Hell

“When fighting against a Grub force that outnumbers you, engage from as far away as possible.”

— UNW Training manual

Date: AL 11:092

Location: Luches Utopian territory.

Situation: En route back to base after a boring escort mission, the escorts encountered a swarm of unknown Grub fighters finishing off a small convoy. The two Mantis attacked the oncoming swarm more in self-defense than an all out deliberate attack.

Vartak A	Weapon C (Gnr 7) Pilot (Plt 4)
Thistle A	Weapon A (Gnr 5) Weapon B (Gnr 5) Pilot (Plt 5)
Thistle B	Weapon A (Gnr 7) Weapon B (Gnr 8) Pilot (Plt 8)
Tiger Moth A	Weapon A (Gnr 4) Weapon B (Gnr 6) Pilot (Plt 6) Weapon A (Gnr 8) Weapon B (Gnr 4) Weapon C (Gnr 7) Weapon D (Gnr 9) Weapon E (Gnr 5)

Forces

Elements of Swarm Zeta 2
Setup first within 5 hexes of Edge 1.

Muckworm A	Pilot (Plt 6) Weapon A (Gnr 6) Weapon B (Gnr 8)
------------	---

Elements of Dreadlock Squadron, Unkulunkulu Archipelago

Setup second within 3 hexes of Edge 3.

Mantis A	Pilot (Plt 9; Gnr 10) Gunner A (Gnr 6) Gunner B (Gnr 8)
Mantis B	Pilot (Plt 7, Gnr 6) Gunner A (Gnr 7) Gunner B (Gnr 7)

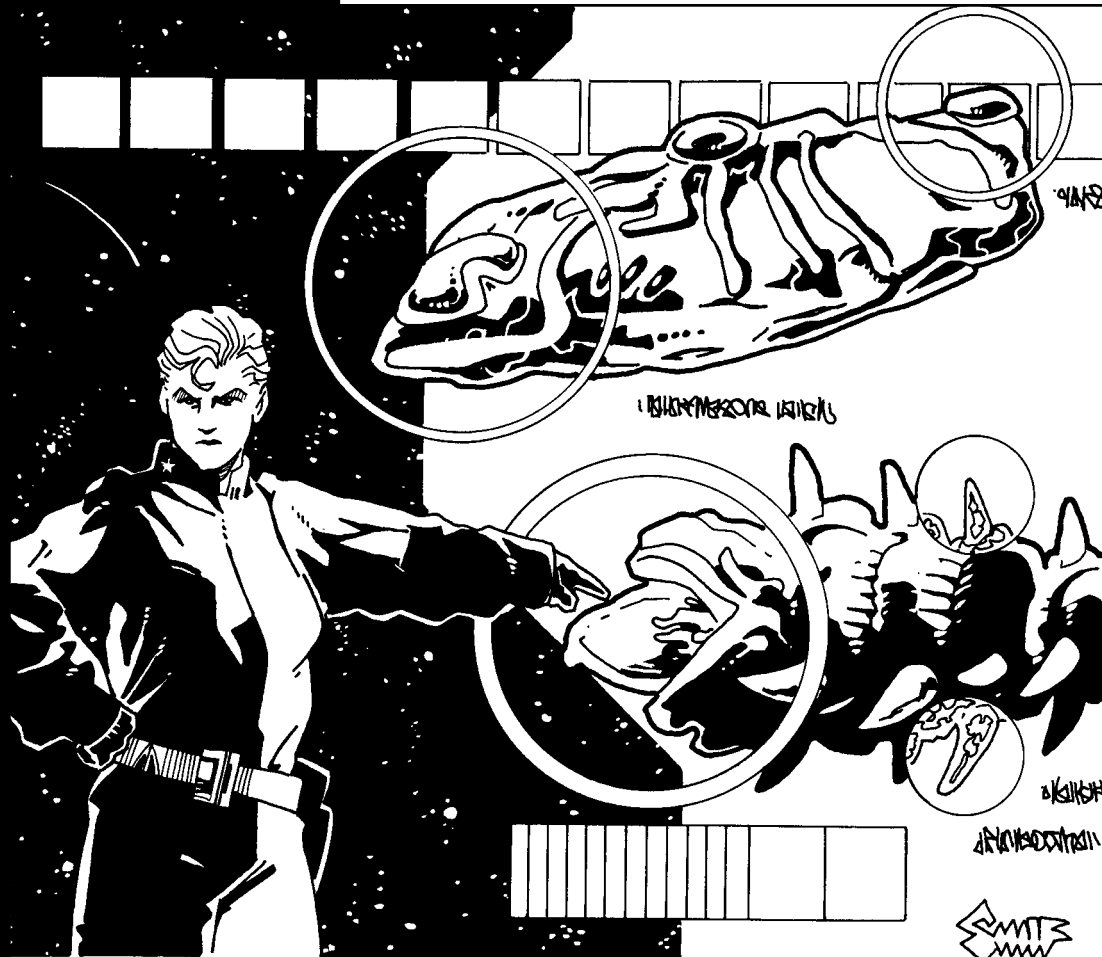

Special Rules

1) Use the Standard map setup.

Victory Conditions

After 10 game turns, the side with the most TPV on the board wins.

Battlefield Report

The Grub swarm consisted of completely new starcraft which neither of the crews of the Mantis had ever encountered. Using their training and sheer bravery, the two Mantis charged the oncoming swarm. The results were fortunate for one of the Mantis while the other became yet another statistic.

Advanced Scenarios

“In war, it is not permitted to make the same mistake twice.”

—Lamarchus, PreImp.

“God sees to it that war will always recur; it is drastic medicine for all non-believers.”

—Midgardian prayer,
unknown

These scenarios use starcraft not available in Silent Death: The Next Millennium. In particular, the Command Escort is used in these scenarios. In order to play with an Escort class starcraft, you must have a copy of Warhounds. Additionally, these scenarios are fairly complex and include more than the usual number of starcraft and optional rules.

Scenario 1: Baptism of Command

Date: AL 11:033

Location: Outside the Hibernian Freehold.

Situation: One of the Universal Night Watch’s largest battles was also one of the earliest. The new Night Watch tactics and weapons were put to the test. Elements of the Task Force Omega went head to head with the elements of a large Grub swarm. The new Command Escort ship and the prototype Command Betafortress was put to the test in this free for all dog fight.

Forces

Elements of Task Force Omega

Setup first within 10 hexes of Edge 1.

Falcon	Captain (Capt 10) Pilot (Plt 10) Gunner A (Gnr 9) Gunner B (Gnr 7) TOC +5, ECM 1-8(6)
Pit Viper 1	Pilot (Plt 8, Gnr 8)
Pit Viper 2	Pilot (Plt 7, Gnr 8)
Pit Viper 3	Pilot (Plt 7, Gnr 7)
Pit Viper 4	Pilot (Plt 7, Gnr 6)
Pit Viper 5	Pilot (Plt 5, Gnr 7)

Pit Viper 6	Pilot (Plt 5, Gnr 6)
Equalizer 1	Pilot (Plt 6, Gnr 7) copilot (Plt 10, Gnr 8)
Beta Command	Pilot (Plt 10, Gnr 9) Gunner A (Gnr 8) Gunner B (Gnr 8) Gunner C (Gnr 7) TOC +1, ECM 1-5(3)
Rattler 1	Pilot (Plt 6, Gnr 6) Gunner A (Gnr 7)
Rattler 2	Pilot (Plt 5, Gnr 5) Gunner A (Gnr 6)
Hornet 1	Pilot (Plt 6, Gnr 10) copilot (Plt 5, Gnr 6)
Epping NW	1 Pilot (Plt 10, Gnr 7) Gunner A (Gnr 9) Gunner B (Gnr 9) Gunner C (Gnr 8)

Elements of Swarm Yankee 93

Setup second within 10 hexes of Edge 3.

Muskellunge A	Pilot (Plt 10) Weapon A (Gnr 6) Weapon B (Gnr 6) Weapon C (Gnr 7) Weapon D (Gnr 6) Weapon E (Gnr 5)
Manta A	Pilot (Plt 9) Weapon A (Gnr 8) Weapon B (Gnr 7) Weapon C (Gnr 10) Weapon E (Gnr 6)
Manta B	Pilot (Plt 8) Weapon A (Gnr 7) Weapon B (Gnr 6) Weapon C (Gnr 9) Weapon D (Gnr 5)
Lamprey A	Pilot (Plt 6) Weapon A (Gnr 6) Weapon B (Gnr 5) Weapon C (Gnr 4)
Lamprey B	Pilot (Plt 5) Weapon A (Gnr 1) Weapon B (Gnr 4) Weapon C (Gnr 4)
Squidge A	Pilot (Plt 8) Weapon A (Gnr 6) Weapon B (Gnr 6)
Squidge B	Pilot (Plt 7) Weapon A (Gnr 6) Weapon B (Gnr 5)
Remora A	Pilot (Plt 10) Weapon A (Gnr 7) Weapon B (Gnr 10)
Remora B	Pilot (Plt 6) Weapon A (Gnr 7) Weapon B (Gnr 10)
Larva A	Pilot (Plt 5)

The Next Millennium

destroyed and the Yoko-Shan troops had vanished.

The pilots returned to find their base in ruins and many of their comrades dead. Without a viable base of operations, the House Colos forces were compelled to temporarily withdraw from the system. Members of the Crimson Death vowed to return and exact vengeance for the deaths of their friends and to remove the smirch on the squadron’s record.

Before House Colos could organize another expedition to the Centel system, it became involved with the UNW. An elite squadron, the Crimson Death found many of its members mustered into the new Night Watch force being formed.

“There they are.”

Decker’s reflection on the past was interrupted by his wing man, Jim Brunner. Decker looked and saw the assault transports of the uThulwani



Silent Death

Brigade approaching on his port side. They were flying in a tight diamond formation that looked as if they were formed up to pass in review.

“Zulu leader to Crimson leader, glad to see you.”

Decker thought the Yoko-Shan officer sounded anything but glad.

Venke contacted Decker on the Colos tactical frequency, “Praetorian to Sniper, take your flight and form up on the far side of their formation. Hey, Decker, remember what I told you, OK?”

“Roger boss, wilco.”

Decker banked his Night Hawk to port and led his flight of four over the Yoko-Shan ships. Seems the dislike is mutual, he thought. As his fighters flashed over the Warworld transports he noticed a number of turrets traverse and track them.

Once the escorting fighters were in position, the combined formation continued on in silence.



Larva B	Weapon (Gnr 6) Pilot (Plt 5)
Larva C	Weapon A (Gnr 5) Pilot (Plt 5)
Larva D	Weapon A (Gnr 4) Pilot (Plt 6) Weapon A (Gnr 4)

Special Rules

- 1) This classical meeting engagement caught both sides by surprise. As a result, for the first two turns, initiative is determined by a straight die roll no modifiers are added.
- 2) Use 2 sets of maps in a Standard Map setup organization. The total area should be a square with 48 hexes along Edge 1 and 72 hexes along Edge 2.

Optional Rules:

Auto Hits, Auto Misses, Damage Control, Drive 0 Turns, Ramming, Time Limit, Variable Speed Torpedoes.

Victory Conditions

After 10 Game Turns, the side with the most TPV on the board wins.

Battlefield Report

The Night Watch quickly learned the value of having a TOC in battle, and the Grubs were taken completely off guard. The Grubs ships hid in Ink Clouds and used their Jump Pods to avoid Terran torpedoes. The Terrans were able to negate some of these tactic by using their Scanners. The Grubs were completely routed and the Terrans lost only 3 fighters. The Grubs were barely able to escape with a wounded Muskellunge, a Remora, and a limping Larva. The victory raised morale throughout Terran space. The Night Watch had proven its worth!

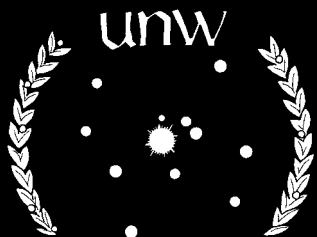

Scenario 2: End of Command

Date: AL 11:042

Location: The dead space between the Unkulukulu Archipelago and House Red Star.

Situation: With most of its fighter cover destroyed, a UNW Escort tried to sneak back to friendly territory. The Grubs had another plan.

Forces

Elements of Vampire Squadron

Setup first within 3 hexes of Edge 1.

Falcon	Captain (Capt 10) Pilot (Plt 10) Gunner A (Gnr 9) Gunner B (Gnr 7) TOC +5, ECM 1-8(6)
Pit Viper 1	Pilot (Plt 8, Gnr 8)
Pit Viper 2	Pilot (Plt 7, Gnr 8)

Arriving turn 4 from Edge 2 or 4:

Hornet 1 Pilot	(Plt 6, Gnr 7) Gunner A (Gnr 10) Gunner B (Gnr 8)
Rattler 1	Pilot (Plt 7, Gnr 7) Gunner A (Gnr 8)
Rattler 2	Pilot (Plt 6, Gnr 10) Gunner A (Gnr 5)

Elements of Swarm Y

Setup second within 10 hexes of Edge 3.

Muskellunge	A Pilot (Plt 10) Weapon A (Gnr 6) Weapon B (Gnr 6) Weapon C (Gnr 7) Weapon D (Gnr 6) Weapon E (Gnr 5)
Manta A	Pilot (Plt 9) Weapon A (Gnr 8) Weapon B (Gnr 7) Weapon C (Gnr 10) Weapon E (Gnr 6)
Manta B	Pilot (Plt 8) Weapon A (Gnr 7) Weapon B (Gnr 6) Weapon C (Gnr 9) Weapon D (Gnr 5)

Lamprey A	Pilot (Plt 6) Weapon A (Gnr 6) Weapon B (Gnr 5) Weapon C (Gnr 4)
Lamprey B	Pilot (Plt 5) Weapon A (Gnr 1) Weapon B (Gnr 4) Weapon C (Gnr 4) (Plt 8)
Squidge A Pilot	Weapon A (Gnr 6) Weapon B (Gnr 6)

Special Rules

- 1) The Escort must exit off of Edge 3.
- 2) Use the Long Map setup.

Optional Rules:

Auto Hits, Auto Misses, Damage Control, Drive 0 Turns, Ramming, Time Limit.

Victory Conditions

The Grubs earn +200 points for the destruction of the Escort, and +25 points for each additional ship destroyed. The Terrans earn +50 points for the destruction of the Muskellunge, and +20 points for each additional Grub ship destroyed.

After 10 Game Turns, the side with the most points wins.

Battlefield Report

The lumbering Escort became the target of the exceptionally brutal combined fire from the swarm. With the loss of the Escort, the remaining fighters became a statistic.

The Next Millennium

Decker found his gaze repeatedly drawn to the Yoko-Shan ships. A blast from my splatterguns would gut one of those transports, he thought. He picked a Warworld ship and closed his eyes. He could see it: a quick blast of fire, the transport reeling, shaking itself apart, small armored figures falling from the broken vessel and spinning off into space.

Decker opened his eyes and his unknowing victim was whole again, cruising steadily onward. Decker's thumb flipped the safety cover off of the joystick's fire button. The bastards deserve it, he thought.

Venke's voice crackled in Decker's headset, "Heads up, folks. I just got a sitrep from the Sorcerers. They're flying a fighter sweep ahead of us and are heavily engaged. They're holding their own, but they just advised that a squadron of Vartaks has broken off and is headed our way. Let's look alive."



Silent Death

Safe for now, thought Decker. You never know what might happen in the heat of battle, though. Not every shot connects with its intended target.

Despite the fact that his ship's sensors would detect the enemy craft long before they were visible to the naked eye, Decker craned his neck to scan the area around his fighter. He glanced down at the scanner display just as twenty enemy ships appeared at the edge of sensor range.

"Sniper to all units, enemy contact bearing nine o'clock, turning to engage. Echo Flight, follow me."

Decker threw his Night Hawk in a hard turn to port and shoved the throttles forward. Out of the corner of his eye he could see the other ships of his flight do likewise.

Although outnumbered, Decker knew that the best chance he had to protect the troop ships was to engage the Grubs at long range and force them into a

Scenario 3: Run for Home

Date: AL 11:072

Location: Outside the Seikam Stellar Cluster

Situation: After a successful raid on a Grub stronghold, elements of Mace Squadron, Celestial Knight Night Watch Wing, including the Escort ship Data 99 and two remaining fighter escorts were returning home to refit for another raid. Unknown to the squadron, a sizable recovery group from the Grub stronghold had made a jump into a wormhole prior to the squadron's raid. After such a devastating defeat at the hands of the Terrans, the Hatchlings were anxious for revenge. The Grubs were attempting to capture or destroy the Escort Command ship which had directed the raid. The Hatchling fighters pursued and immediately picked up the trail of the Escort and the fighter cover. The race began to see if the Escort Command ship could make it back to friendly territory before the Grubs could catch it.

Forces

Elements of Mace Squadron, Celestial Knights

Setup first in area A along Edge 1.

Falcon	Captain (Capt 7) Pilot (Plt 9) Gunner A (Gnr 7) Gunner B (Gnr 9)
Thunder Bird NW A	Pilot (Plt 8; Gnr 7)
Thunder Bird NW B	Pilot (Plt 7, Gnr 8)

Elements of Recovery Group Zeta

Setup second along Edge 2.

Larva 1	Pilot (Plt 6, Gnr 6)
Larva 2	Pilot (Plt 5, Gnr 6)
Larva 3	Pilot (Plt 5, Gnr 6)
Lamprey 1	Pilot (Plt 5) Weapon A (Gnr 6) Weapon B (Gnr 8) Weapon C (Gnr 3)
Remora 1	Pilot (Plt 5) Weapon A (Gnr 8) Weapon B (Gnr 9)

Special Rules

1) All of the Terran ships move prior to any Grubs for the first turn.

Optional Rules:

Auto Hits, Auto Misses, Damage Control, Drive 0 Turns, Ramming, Side slips, Time Limit.

Victory Conditions

After 10 game turns, compare victory points. If the point total is above zero, the Terrans win, if the point total is below zero the Grubs win. If the point total is zero, it is a draw.

Escort escapes: +100

Escort & Fighters escape: +150

Lamprey killed: +75

Remora killed: +50

Each Larva killed: +25

Escort captured: -200

Escort towed off board: -500

Escort killed: -150

Each Thunder Bird killed: -50

Battlefield Report

The Grubs immediately attacked the Escort, trying to surround the ship in a Drone field to limit its maneuverability. This strategy had only a limited success. The Grubs then tried attacking with Drive Leeches. The Escort was able to fend off the attack with the help of the fighter cover. The Terrans did not lose a single starcraft, although the Thunder Birds were badly damaged and were moving quite slowly.

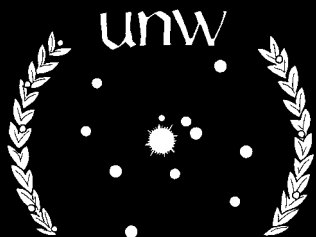

New Terran Starcraft

“War is delightful to those who have no experience of it.”

—Erasmus, PreImp

Several design factors are apparent in the development of the new starcraft for Night Watch units. First is the absence of anti-torpedo systems, since these systems provide no defense against Drones or other Grub weapons. The hyper drive of the Drones also makes them too fast for point defense systems to be effective. In addition, UNW scientist have been unable to analyze the drone tracking mechanism. This make decoys and jamming ineffective. To date, there is no specific anti-Drone weapon. However, Night Watch tactics include the use of MK. 10 torpedoes as an effective anti-Drone weapon.

Historically, most Terran ships were also unable to get a first shot off at the Grubs. The Grub ships usually initiated combat by firing all of their weapon systems before the poor Terran pilot could fire! Designers decided that the Night Watch starcraft would generally contain at least two crew: a pilot and a gunner. This would give the Terrans' some offensive punch prior to or simultaneous to the Grubs'. UNW ships were redesigned to give the gunner the most potent weapon, so that the weapons could inflict maximum damage immediately. Finally, numerous R&D designers decided that additional armor was ineffective against the Grubs. It was speed and better shielding that drastically increased the survivability of crew and ship. High speeds prevent the larger Grub weapons systems from tracking the Night Watch ship, therefore rendering the weapons useless. Since armor is also sacrificed in favor of speed and defenses, most UNW ships have no Damage Reduction. Here are the 5 new fighters, 1 new gunboat, and 1 new Escort class command ship introduced in Universal Night Watch.

Pyramid's Shipyards "Falcon" Command Escort

Crew: 23

Maneuver Thrust: 0.1190 km/s/s

Mass: 5,000 tons (Corvette)

Translight Capability: 24 light-years/day

Armor: Crystanium hull w/alloy belt

Atmospheric Capability: None

EFS: None

Command Components:

Type 5 Tactical Operations Center

Highest grade Scanners

Armaments:

16 x Mk. 10 Splattergun Blast Cannons

4 x Meld Laser

4 x Hammerhead Missile Launcher (magazine: 20)

The addition of the Command Ship was deemed as imperative for UNW units. Although the Escort's offensive punch was reduced, this deficiency is more than compensated for by the powerful electronics suite and efficient TOC. The results of this refit is not cheap, but the battlefield results more than makes it all worth while. As was overheard at CentCom's long range planning center, "The Escort Command Ship, don't leave base without it".

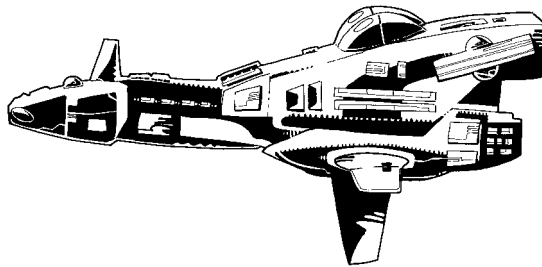

The Next Millennium

dogfight. If the Hatchling ships got in close to the lightly armored transports with their spore mole launchers, the troops inside would take heavy losses. Not that I really care, Decker reminded himself, but it's a matter of professional pride. No one is going to hit those transports but me.

The range to the Vartaks dropped rapidly. If the Grubs were acting true to form, they would use their jump pods to try to leapfrog over the attacking Night hawks and close with the transports.

"Sniper to Echo flight, slow to half speed, on my signal engage full reverse thrust."

Decker glued his eyes to the range readout on the scanner. He wasn't sure exactly what range he was waiting for, he would just have to trust his instincts. Their X-beams outrange us, he thought, they'll probably fire a volley and then jump.

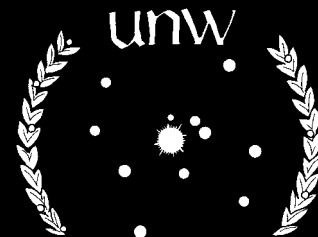

Silent Death

The range continued to drop steadily. Just outside of the X-beam's maximum range, Decker gave the signal. "Now!"

Decker yanked the throttles back and fired his forward thrusters. The Night Hawk's shields flared briefly as a weak X-beam bolt splashed against them without penetrating. The fighter's velocity dropped rapidly. In the distance, Decker saw the Hatchling ships disappear into hyper space.

Seconds later, a Vartak appeared directly in front of his fighter, less than two hundred yards away.

It worked! The Night Hawks' sudden maneuver had caused the Grubs to mistime their jump. Instead of jumping over the Colosian ships, they had fallen short and appeared directly in front of them.

The missile lock cue screeched in Decker's ear. He mashed down savagely on the joystick trigger and ten missiles rippled from his ship. Even before the mis-

Comet-Coyote Speed Designs X17A "Firebat"

Crew: 2

Maneuver Thrust: 0.171 km/s/s

Mass: 300 tons

Translight Capability: None

Armor: Steel

Atmospheric Capability: Full

EFS: Type 1

Armaments:

- 1 x Mk. 10 Tachyon Ram
- 1 x Hammerhead Missile Launcher (magazine: 10)
- 10x Mk. 10 DLT Torpedoes

Prior to the Grub-Terran War, Comet-Coyote was a designer of fast, agile racing starcraft. Working closely with the ASP tech staff, Comet-Coyote was always on the cutting edge of new advancements to starcraft computer systems. After the war there was little demand for racing starcraft.

Looking for new markets, the Comet-Coyote designers submitted a bid for a light fighter to the newly formed Central Command of the Universal Night Watch. The bid was awarded and the Firebat was developed to fight the light Grub fighters and recovery ships. The Firebat sports a sound design and a nice offensive punch, but also suffers from a problem. The hull was designed to stand up to stress developed from high speeds and quick maneuvering turns, not combat type damage. This translates into a starcraft that tends to fall apart quickly in combat.

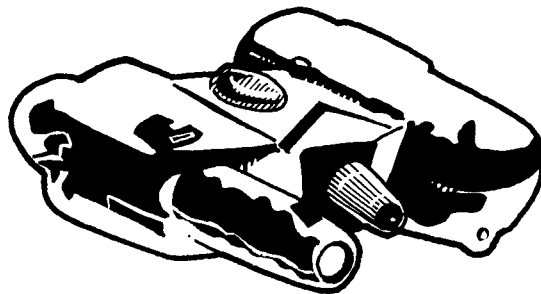

Mitsuzuki Amalgamation Type 400 "Rattler"

Crew: 2

Maneuver Thrust: 0.163 km/s/s

Mass: 400 tons

Translight Capability: None

Armor: Crystanium w/belt

Atmospheric Capability: Full

EFS: Type 1

Armaments:

- 1 x Mk 10 EMP Ray
- 6 x Mk. 10 Splattergun Blast Cannons
- 10 x Mk. 10 Explosive Torpedoes

Normally concerned with developing pleasure yachts for well-to-do families, Mitsuzuki saw a decline in market after the last Grub-Terran War. Like many other businesses, they turned towards the lucrative military markets. The UNW commissioned them to design and to produce a medium fighter intended to be a companion to the Salamander NW. So far, the Rattler has proven itself to be a very reliable design capable of delivering a strong offensive punch while capable of absorbing a moderate amount of damage. The EMP Ray, which was "donated" to Central Command as a gift from the Sunrunners, is used along with a destructive sextet of Splatterguns to keep Grubs away from the forward 180°. The addition of the Mk. 10 torpedoes adds to the firepower. However, the Rattler is vulnerable to any attack in the rear quarters, which concerns many Rattler crews.

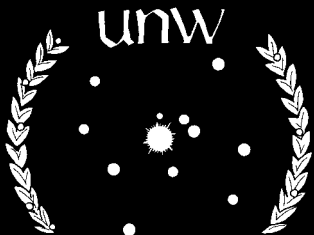
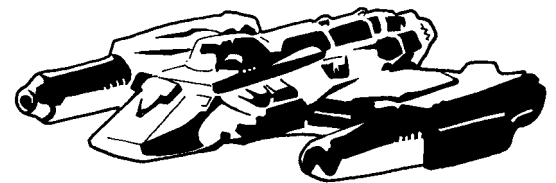

Military Building Systems FX24 "Hornet"

Crew: 2

Maneuver Thrust: 0.151 km/s/s

Mass: 600 tons

Translight Capability: None

Armor: Steel

Atmospheric Capability: None

EFS: Type 2

Armaments:

- 1x Mk. 15 Ion Ram
- 1x Mk 10 Impulsegun Ion Cannon
- 1 x EMP Beam
- 15 x Mk. 10 Explosive Torpedoes

Abandoning traditional designs, the Hornet incorporates a revolutionary new concept in combat fighters: dual control systems of both piloting and gunnery. This system is normally used in training ships and not actual combat starcraft. This redundancy increases the survivability of the ship by enabling either the pilot or copilot to fly the starcraft or to fire the weapons systems. Control of the piloting and gunnery can be switched as required.

Since the Hornet was M. B. S.'s first foray in fighter starcraft production, there are some flaws in the Hornet's design. The ship is vulnerable to rear and flank attacks, but the Ion Ram and the EMP Beam ensure that the Hornet has some stand off capability. Although the Hornet ran into some difficulty on the drawing board, it has turned into a solid and very dependable starcraft.

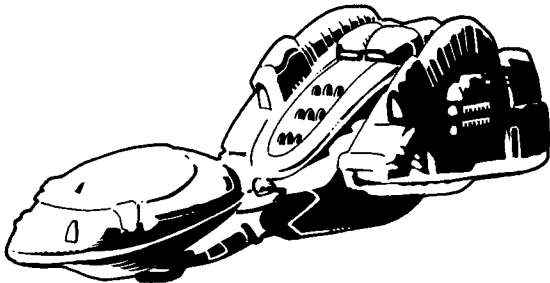

Military Building Systems FX34 "Equalizer"

Crew: 2

Maneuver Thrust: 0.160 km/s/s

Mass: 700 tons

Translight Capability: None

Armor: None.

Atmospheric Capability: None

EFS: Type 3

Armaments:

- 1 x Mk. 15 Tachyon Cannon
- 2 x Mk. 10 Splattergun Blast Cannons
- 1 x Hammerhead Missile Launcher (magazine: 20)
- 10 x Mk. 10 DLT Torpedoes

Having learned some valuable lessons from the development of the Hornet, M. B. S. designed an even better starcraft with the creation of the Equalizer. All research and development was done internally and the final product was then offered to the Central Command UNW. The ship includes dual pilot and gunner controls and incorporates new defensive technology. The Tachyon Cannon is a favorite with UNW crews while fighting Hatchlings. While the Equalizer is a better starcraft than its predecessor the Hornet, it has gone over budget and is somewhat under-gunned for a middle weight fighter.

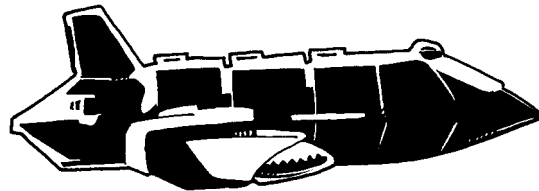

The Next Millennium

siles impacted, the fighter's six splatterguns began to rake the hapless Grub ship, gouging huge holes in its frame. The missiles reached their target and the Vartak disintegrated into a cloud of burning debris. Decker slammed the throttles forward and rolled hard right to avoid a collision with the remains of his enemy.

Taken by surprise, three other Vartaks perished before Echo Flight's sudden onslaught. The others turned to flight.

The battle quickly degenerated into a swirling dogfight. Anxious to get at the transports, the Grub ships dropped drones to hinder their opponent's maneuverability and then opened the range with their jump pods.

Desperate to pursue them, Decker wove recklessly between the enemy drones. One activated as he flashed by, but missed his ship by a narrow margin. A blinding flash behind him told Decker that the drone had con-



Silent Death

nected with something. He spared a quick glance at the scanner—the icon representing Brunner's ship was gone.

Damn! No time to think about it now.

The Night Hawk shot clear of the drones and headed back toward the transports. Decker could see the formation ahead, from this distance the fire being put up by the turret gunners made it resemble a giant laser-quilled porcupine.

The Vartaks had already reached the transports and were mixing it up with the other escorts. The Grub ships were dodging in and out of the formation, using the transports for cover and forcing the defenders to risk hitting each other. Decker saw a few troop ships stagger out of position as the deadly spore moles began to take their toll.

Decker's fighter reached the edge of the transport formation. A Vartak flew up through the Yoko-Shan ships and flashed across his sights. The Grub fighter

Backnet Outfitters GTX "Javelin"

Crew: 3

Maneuver Thrust: 0.134 km/s/s

Mass: 700 tons

Translight Capability: None

Armor: Crystanium w/belt

Atmospheric Capability: None

EFS: Type 3

Armaments:

12 x Mk. 10 Pulse Laser Cannons
1 x Mk. 15 Ion Ram Cannon
10 x Mk. 10 DLT Torpedoes
3 x Hammerhead Missile Launcher (magazine: 20)

The Backnet Outfitters' first entry into the military starcraft market appears to be right on track. The Javelin was designed to be a companion to fighter starcraft, and as such has a high speed compared to other gunboats. Its missile capability is second only to the Epping. Added to the speed is a high defensive capability that adds survivability to a gunboat unsurpassed by any other design.

Don't expect the Javelin to be the primary assault craft and live to tell about it. Its primary roll is to go in behind the fighters and unload its Hammerhead missiles. There are some problems with the Javelin. As a light gunboat it cannot take a lot of combat damage. Also, in order to achieve the speed required to keep up with fighters, oversized engines were added that are extremely exposed to the flanks and rear.

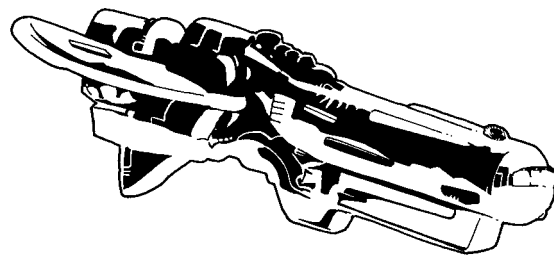

Military Building Systems FX4 I "Praying Mantis"

Crew: 3

Maneuver Thrust: 0.143 km/s/s

Mass: 1000 tons

Translight Capability: None

Armor: Steel

Atmospheric Capability: Full

EFS: Type 3

Armaments:

12 x Mk. 10 Splattergun Blast Cannons
3 x Hammerhead Missile Launcher (magazine: 20)
10 x Mk. 10 DLT Torpedoes

The Mantis follows the more traditional design of a single pilot and dedicated gunners. While this approach doesn't benefit from the redundant systems found on the other two ships, it does help to cut down the cost. The Mantis also incorporates the most effective weapon systems known against the Grubs: Hammerhead missiles and massive amounts of cannons. The three quad Splattergun mounts command almost an entire 360 degree defense for the craft and they add tremendous hitting power to the front. The three missile launchers are excellent at engaging targets at longer ranges, and the torpedoes help the Mantis out of sticky Drone problems.

Although it is an expensive ship, it did not go over budget and it does what it was designed to do very well, and of course that's killing Grubs! Many Grub starcraft have fallen victim to this hunter. A favorite with Night Watch crews.

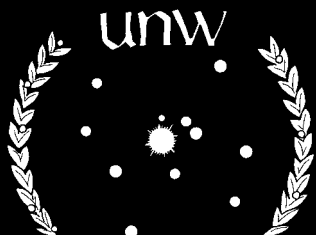
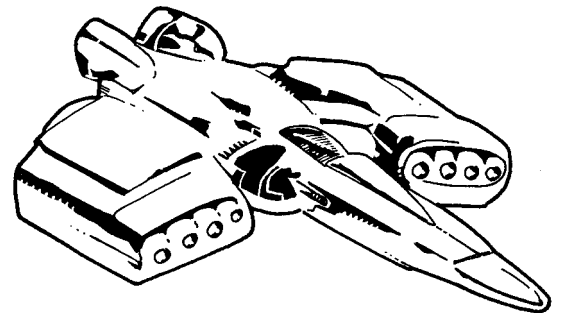

New Grub Starcraft

"War with the Grubs is a terrible thing."
—imp 504

"War with the Grubs is a terrible thing!"
—AL 11

Hatchling Starcraft Type H-1256b "Muckworm"

Maneuver Thrust: 0.181 km/s/s

Jump Pods: 2 poor, 2 fair

Special Equipment: None

Armaments:

- 1 x X-Beam
- 1 x X-Beam w/Ink Dispenser (3 canisters)
- 1 x Spore Mole Launcher (magazine: 10)

The Muckworm was encountered during the Grub-Terran First Contact War in small numbers. Initially they were very rare, though they became more common as the conflict progressed.

The combination of ink, the two beam weapons, and Spore Moles make the Muckworm a formidable medium fighter. In initial engagements it was devastatingly effective against light and medium fighters. It is hard enough to hit that its total lack of armor isn't really a handicap, as Terran gunners rarely connect. Because the Muckworm has no Type 1 Drones it relies on its speed and Jump Pods for torpedo defense. It uses type 2 Drones to keep Terrans at bay or pinned down.



Hatchling Starcraft Type H-6382r "Vartak"

Maneuver Thrust: 0.161 km/s/s

Jump Pods: 2 poor, 2 fair, 2 good

Special Equipment: None

Armaments:

- 1 x X-Beam w/Ink Dispenser (3 canisters)
- 1 x Spore Mole Launcher (magazine: 20)
- 8 x Type 2 Drones

The Vartak was unknown during the Grub-Terran First Contact War. Its high speed coupled with numerous Jump Pods makes the Vartak highly maneuverable. It was probably developed because of the tremendous success that ships bearing the Spore Mole Launcher had. The whole ship is apparently designed around that weapon. Its normal attack profile includes using its tremendous speed and JumpPods to get behind the largest of the Terran starcraft, using ink for cover, then unleashing the Spore Moles. The Vartak then uses the Drones to cover its escape.

While the Vartak operates well with most Hatchling ships, it excels when used in conjunction with the Squidge, other Vartak, and the Larva.



The Next Millennium

dove back down into the formation, narrowly missing a transport. Decker rolled onto the Grub's tail and pursued.

As Decker dove past the transport, he saw the ship's turret swing around until it was pointing directly at his fighter. The muzzles of the dual blatguns yawned like twin caverns before him. They fired.

The Night Hawk shuddered and began to tumble. Blinded by the flash, and surprised to be alive, Decker struggled with the controls. The ship careened wildly through the close-packed transports.

The fighter shook again as something landed a sledgehammer blow on its right wing. The wailing of alarms filled the cockpit. Still half-blinded, Decker fumbled for the ejection button. He found and pushed it. Before he could hit it again, to confirm the order, the Night Hawk convulsed in agony, slamming Decker's head against the canopy.

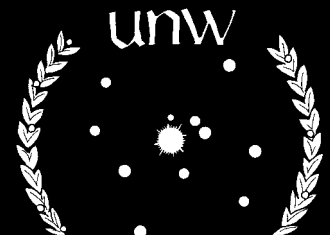

Silent Death

His world a red haze of pain, Decker struggled to focus on the fighter's console. The sound of ripping metal competed with the blare of alarms. He located the ejection controls and stabbed the button. Sudden acceleration flung him back against his seat and he blacked out.

The world came back into focus gradually. Decker found himself looking up into the smiling face of a uThulwani trooper in full battle armor.

"Captain, he's conscious."

A froth of rage boiled up through Decker's pain-clouded mind. He reached down for his pistol and started to sit up. A wave of nausea stopped him short and he laid back down. He could hear the blare of blatguns firing in the background.

"You bastards shot me," he gasped.

A new face appeared above him. Judging by the newcomer's armor, he was an infantry captain.

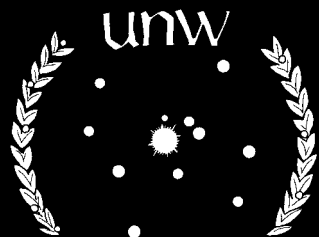

Refit Starcraft

"War must be for the sake of peace, business for the sake of leisure, things necessary and useful for the sake of things noble."

—Aristotle, PreImp

"Hell hath no fury like what happens to you when you shoot the target of a Utopian crew bucking for promotion."

—Anonymous

Many Terran starcraft have been modified by units that have been in combat with the Grubs. Ships that were selected by the Universal Night Watch Central Command for official refit are designated by the "NW" at the end of the starcraft type, such as a Nighthawk NW. One change consistent with Night Watch ships is the addition of special electronics gear that allows the fighters to take advantage of a data link with a Command ship. Only starcraft custom built for Central Command for Night Watch units or those with the NW suffix can benefit from a data link.

UNW refit craft have actually undergone significant re-engineering. Unlike standard refits that upgrade an armaments package, major changes have been made in these once familiar craft. While extensive preparation to replace the anti-torp equipment with the extensive NW electronics package were underway, the UNW R&D took advantage of the situation to improve the Here are seven Silent Death: The Next Millennium starcraft that have been approved for modification by Central Command for Night Watch duty. These ships are arranged in Basic Point Value order from smallest to largest.

Thunder Bird NW

NW BPV: 32

Crew: 1

Maneuver Thrust: 0.155 km/s/s

Mass: 200 tons

Translight Capability: None

Armor: Crystanium w/belt

Atmospheric Capability: Full

Armaments:

4 x MK. 10 Pulse Laser Cannons

1 x Hammerhead Missile Launcher (magazine : 10)

4 x MK. 10 DLT Torpedoes

Chosen by Central Command to destroy the Larvae, the Thunder Bird was easy to refit. The Point-Defense system and the Decoys were removed to increase the overall defensive equipment, making is substantially tougher to hit. The Mk. 20 torpedo was removed and replaced with an externally mounted missile pod containing 10 Hammerhead missiles. The Mk 10 Explosive Torpedoes were replaced with DLT Torpedoes. To date, Central Command is extremely satisfied with the refit.

Teal Hawk NW

NW BPV: 50

Crew: 2

Maneuver Thrust: 0.177 km/s/s

Mass: 300 tons

Translight Capability: None

Armor: Crystanium w/belt

Atmospheric Capability: Full

Armaments:

2 x Mk. 15 Blatgun Blast Cannons

1 x Mk. 10 DLT Torpedo

Central Command chose the Teal Hawk to provide Night Watch units with a solid scout that could double as a medium fighter. The speed was deemed fast enough to keep the Teal Hawk out of the Grub's big guns targeters and the armor is more than adequate to repel a good portion of the damage delivered by Grub beam weapons. The Point-Defense system and the Decoys were removed to increase the overall defensive equipment, making is dramatically tougher to hit. Many designers were in favor of replacing the Blatguns with a larger array of Splatterguns; still others had different ideas. The final decision was based upon the bottom line. The refit had to be relatively cheap to be approved, and design-

ers argued that the Blatguns were able to engage the heavy and medium Grub ships and inflict a fair amount of damage. The budget minded of Central Command had their way with the Teal Hawk refit program. The answer is still out as to the effectiveness of letting budget be the driving factor.

Nighthawk NW

NW BPV: 57

Crew: 1

Maneuver Thrust: 0.150 km/s/s

Mass: 300 tons

Translight Capability: None

Armor: Crystanium w/belt

Atmospheric Capability: Full

Armaments:

- 6 x MK. 10 Splattergun Blast Cannons
- 1 x Hammerhead Missile launcher (magazine: 10)

By far the most effective ship against the Grubs in the first war, the Nighthawk was an obvious choice for a refit. The ineffective Meld Laser was replaced by a rack of ten Hammerhead missiles. Needless to say, the final result is a winner. The combination of the sextet Splatterguns and the extended range of the Hammerhead missiles make the refit Nighthawk even better than before.

Lance Electra NW

NW BPV: 69

Crew: 2

Maneuver Thrust: 0.141 km/s/s

Mass: 420 tons

Translight Capability: None

Armor: Crysteel w/belt

Atmospheric Capability: None

Armaments:

- 2x Protobolt Projectors (Ammo: 4 protobolts each)
- 1 x MK. 10 Pulse Laser
- 1 x Hammerhead Missile launcher (magazine: 20)
- 2 x MK. 30 DLT Torpedoes
- 2 x MK. 10 DLT Torpedoes

The Lance Electra is probably one of the most enthusiastic and risky refits to date. Chosen by Central Command to combat the Squidge and the Manta with Protobolts,

this refit ran into problems from the beginning. First, the overall design of the Lance Electra is not well suited for Night Watch duty. It is too slow and too easy a target for Grub weapons. In order to increase the drive, new engines were added. A new defensive package was installed, one again at the expense of the Point-Defense system and the Decoys. On top of this, the single Pulse Laser was moved to the gunner. All of these upgrades spell one thing for the Lance Electra NW: way over budget and slow to enter the field. Central Command has currently halted the project and is reevaluating the entire Lance Electra refit project.

Salamander NW

NW BPV: 70

Crew: 2

Maneuver Thrust: 0.159 km/s/s

Mass: 400 tons

Translight Capability: None

Armor: Crystanium w/belt

Atmospheric Capability: Full

Armaments:

- 1 x MK. 10 Impulse Ion Cannon
- 2 x MK. 10 Splattergun Blast Cannon
- 1 x Hammerhead Missile launcher (magazine: 10)
- 4 x MK. 10 DLT Torpedoes

An all around favorite with everyone from crew to politicians, it came as no surprise that the Salamander was selected for refit. Already a well balanced medium fighter, the Salamander was extremely easy to refit. The biggest concern was the ease with which the ship could be hit by Grub beam weapons so the defensive systems were replaced. The most controversial alteration was the removal of the 360° Pulse Laser in favor of a Hammerhead Missile launcher. The loss of the Pulse Laser was not well accepted by commanders. However, Central Command thought that the Missile load would be worth the loss of 360° Pulse Laser coverage. Overall, the design of the Salamander made the refit project run ahead of schedule and under budget. This has allowed an extensive parts program and made aggressive roll-out to Night Watch units possible.

The Next Millennium

“We most certainly did not. You were so intent on following that Vartak, you didn’t notice his partner move up on your stern. Our gunner tried to clear him off your tail, but must have fired a fraction of a second too late. When you went tumbling out of control, another Grub finished your ship off.

“We saw you eject and I ordered our pilot to break formation and go after you. We’re trying to catch up with the rest of the transports now.”

It took a few seconds for the full import of the captain’s words to penetrate Decker’s muddled thought processes. Leaving the formation meant abandoning the safety of the other transports’ support fire. It also endangered the others by depriving them of this ship’s fire. They did it to rescue him.

Decker struggled up into a sitting position. Through one of the armored firing ports he could see the battle still

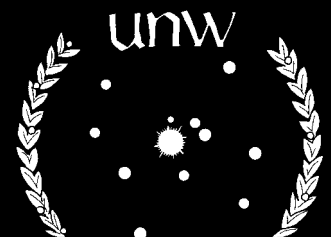

Silent Death

raging above them. If a Grub ship noticed them straggling, they could all be killed.

He looked from the firing port to the stress-lined faces of the warriors lining the inside of the transport and back to the firing port.

And realized who the true enemy was.

This was FUN

Writing this Forces book was a change for us. In the past, present, and future, we have provided ICE with play testing and running demonstrations of Silent Death at the big conventions. We also created Shipbuilder and the forthcoming Space Docks. When ICE asked if we would be interested in creating a Silent Death Forces book, we had to think about it for a while. It is a big jump from player to designer. The biggest challenge was to create reasonable weapons and starcraft. In the end, we decided this was a lot of work and that playing was more fun. At least when you play some other designers scenarios, you can complain about balance and the lousy starcraft.

Epping NW

NW BPV: 139

Crew: 4

Maneuver Thrust: 0.109 km/s/s

Mass: 1000 tons

Translight Capability: None

Armor: Fortified Crysteel

Atmospheric Capability: Full

Armaments:

12 x MK. 10 Pulse Laser Cannons

3 x Hammerhead Missile launcher (magazine: 25 each)

1 x Hammerhead Missile launcher (magazine: 10)

4 x MK. 30 DLT Torpedo

Although the Epping is slow and an easy target for Grub weapons, the end result of the Epping refit program has had overwhelming acceptance. The Epping NW's most deadly weapon system is without question its 85 missiles. The original missile load was replaced with Hammerheads, which gives the Epping NW an extended offensive combat striking range. Additionally, the pilot's Meld Laser was removed and another rack of 10 Hammerhead missiles was added under the pilot's control.

With a skilled crew this ship is a terror.

Command Betafortress NW

NW BPV: 250

Crew: 10

Maneuver Thrust: 0.067 km/s/s

Mass: 1500 tons

Translight Capability: 5 light-years/day

Armor: Reinforced Crystanium

Atmospheric Capability: None

Special Equipment:

Type 1 Tactical Operations Center

Medium Grade Scanners

Armaments:

4 x MK. 15 Blatgun Blast Cannons

3 x Hammerhead Missile launcher (magazine: 20 missiles each)

10 x MK. 10 DLT Torpedo

The Betafortress was not chosen for a refit not for its fire power, but for its ability to be converted to a Command and Control center. The Falcon class corvettes had already been chosen to be the overall Night Watch Wing Command and Control starcraft, but the Central Command wanted Command and Control capabilities at the Squadron level, but the corvettes were too expensive to be used in this role. The Betafortress was chosen by default. The 360° Plazgun mounts, Splattergun mounts and the MK. 50 torpedoes were removed. This made enough room to add a small Tactical Operations Center, TOC, Scanner Suite, and the associated array needed to establish data links. Even though this degraded the offensive firepower of the Betafortress, it did not degrade the offensive capabilities of the ship. This was one of the most surprising refits that the Grubs have encountered to date, and the Command and Control capabilities have proven a thorn for the Grubs. These babies have been incorporated into most Night Watch Wings and will be migrated to the squadron level as soon as all units have received at least one Command Betafortress NW.

