

# SILENT DEATH™

# HOUSE



# SIGURD™

## ARCHDIOCESE



**A Silent Death sourcebook expanding the influence of the Church of Odin.**

# Sigurd Archdiocese™

# The Next Millennium

## Credits



**Original System Design:** Kevin Barrett

**Sigurd Archdiocese Author:** Scott Sigler

**Cover Illustration:** Alan Gutierrez

**Interior Illustration:** Dan Smith

**Miniatures Sculptor:** Bob Naismith

**Series Editor:** Donald G. Dennis

**Art Direction:** Jessica Ney-Grimm

**Assisting Art Direction:** Jason O. Hawkins

**Cover Design:** Donald G. Dennis

**Pagemaking:** Steven Arensberg, Wendy Frazer, Sherry Robinson

**Editorial Contributions:** Bruce Neidlinger, Heike Kubasch

### ICE Staff:

*CEO:* Bruce Neidlinger;

*President:* Pete Fenlon;

*Managing Editor:* Coleman Charlton;

*Sales Manager:* Deane Begiebing;

*Sales, Customer Service and Operations:* Becky Blanton, Steve Hardy,

Olivia Johnston, Dave Platnick,

Karina Swanberg, Monica Wilson;

*Print Buying and Rights Director:*

Kurt Fischer

*Editing, Production, and Development:*

John Curtis, Donald G. Dennis,

Wendy Frazer, Jason Hawkins,

Bob Mohny, Nick Morawitz,

Jessica Ney-Grimm, Michael Reynolds,

Sherry Robinson;

*Shipping and Receiving:* Dave Morris,

Daniel Williams, Chad McCully.



Copyright © 1997 by  
**Iron Crown Enterprises.**  
All rights reserved.

No reproductions without  
the express written

consent of **Iron Crown**

**Enterprises.** Produced

and distributed by **Iron**

**Crown Enterprises, Inc.,**

P.O. Box 1605,

Charlottesville, VA 22902.

Phone: (804) 295-4280.

Fax: (804) 977-4811.

Internet e-mail:

askice@aol.com

walsfeo@aol.com



# Silent Death

## Contributors:

Peter Sauerbrei;  
The Good, The Bad,  
and The Unlucky: Paul  
Carroll, Chris Kuhn,  
Don Jenkins, Alan  
Nuss;

Castle Archon: Jim  
Eisert, Andrew  
Thompson;

Ottawa Redshirts:  
Richard Dufault, Glen  
Simpson, Scott  
MacGregor, George  
MacLure, Brad Hector,  
Michael Smith;

# Table of Contents

|   |    |   |    |
|---|----|---|----|
| <b>Introduction</b> .....                                 | 3  | <b>Sigurd Scenarios</b> .....                   | 33 |
| Revelation .....  | 3  | Scenario 1: Border Patrol .....                 | 33 |
| The Religion Grows .....                                  | 4  | Scenario 2: Pilot Retaliation .....             | 34 |
| A House Reborn .....                                      | 6  | Scenario 3: Newts for Breakfast .....           | 35 |
| Rise to Power .....                                       | 7  | Scenario 4: Done with Mirrors .....             | 36 |
| The Grubs .....   | 8  | Scenario 5: The Luck of the<br>Hibernians ..... | 38 |
| Thor's Hammer .....                                       | 8  | Scenario 6: Patchwork .....                     | 40 |
| The Loki Strategy .....                                   | 9  | <b>Nomenclature</b> .....                       | 47 |
| War Heroes .....  | 10 | Brawn Factories SIG100-A "DAGGER" .....         | 47 |
| Refugee Planets .....                                     | 10 | Brawn Factories SIG204-B "HOUND" .....          | 48 |
| Deep Hosk Congress .....                                  | 10 | Deussenson KA-27 "HAMMER" .....                 | 48 |
| Ewanoma Cluster .....                                     | 10 | Deussenson KAJ-B "STORM" .....                  | 49 |
| House Shantac .....                                       | 11 | Deussenson KAJ-C "STORM II" .....               | 49 |
| Sector Protectors .....                                   | 11 | Pyramidis-Brawn S102 "LONGBOAT" .....           | 50 |
| Other Planets .....                                       | 12 | Brawn Factories BRN-72D "ICEBERG" .....         | 51 |
| Gunther Guttman .....                                     | 12 | <b>Sigurd Refits</b> .....                      | 52 |
| <b>Political Relations</b> .....                          | 12 | YK Shipyards Y700.YK "SPIRIT RIDER III" .....   | 52 |
| House Colos .....   | 13 | Jasper Machines Y910b G1/U3 "GLAIVE III" .....  | 53 |
| House Red Star .....                                      | 13 | Vott-Messerschmitt VMe. SA "PIT VIPER II" ..... | 53 |
| House Tokugawa .....                                      | 14 | <b>Worlds of the Sigurd Archdiocese</b> .....   | 54 |
| Yoko-Shan Warworld .....                                  | 14 | Midgard .....                                   | 54 |
| Kashmere Commonwealth .....                               | 15 | Simbulia .....                                  | 55 |
| <b>Hibernian Freehold</b> .....                           | 16 | Reiger 6 .....                                  | 55 |
| ASP Technocracy .....                                     | 16 | Kamchatka .....                                 | 56 |
| DataSphere .....  | 17 | New Denmark .....                               | 57 |
| Unkulunkulu Archipelago .....                             | 17 | Yak-Shindichi .....                             | 57 |
| Q'raj Void Protectorate .....                             | 18 | Yak-Tarull .....                                | 58 |
| Luches Utopia .....                                       | 19 | Agomio .....                                    | 59 |
| <b>Timeline</b> .....                                     | 20 | Niflheim .....                                  | 59 |
| <b>New Weapons</b> .....                                  | 23 | Jbalerbru .....                                 | 60 |
| Gauss Technology .....                                    | 23 | JuTunheim .....                                 | 60 |
| <b>Famous Wings of the<br/>  Sigurd Archdiocese</b> ..... | 25 | Hvergglimir .....                               | 60 |
| "Thor's Hammer" .....                                     | 25 | Panthalassa .....                               | 61 |
| "Loki's Kids" .....                                       | 26 | Laurentia .....                                 | 61 |
| "Tyr's Tyrants" .....                                     | 27 | <b>Sigurd Terminology</b> .....                 | 62 |
| "Storm of Odin" .....                                     | 27 |   |    |
| "Viking Vanguard" .....                                   | 28 |   |    |
| "Valkyries" .....   | 29 |   |    |
| "Missionaries of Death" .....                             | 29 |   |    |
| "Frigid Witches" .....                                    | 30 |   |    |
| "Serpent Death" .....                                     | 31 |   |    |
| "Beastslayer" .....                                       | 32 |   |    |



## Revelations

Bing Wesson drove another clamp into the rock face, wrapping a rope through it and around himself. He tied himself in tighter and tighter. Less than a minute before a high wind lifted Leif Rassmussen like a toy and cast him down the mountain. Bing didn't intend to follow him.

Four of the climbing party's seven members remained alive. Rahmaahd had bought it only seconds after the storm began, crushed by a falling rock. Guttman had moved on as soon as the winds started; he was surely dead as well.

Served Guttman right. None of the party knew Guttman when they started. Bing met him through a tourism office netsite. The man possessed a great climbing rating and Bing had welcomed him along for the

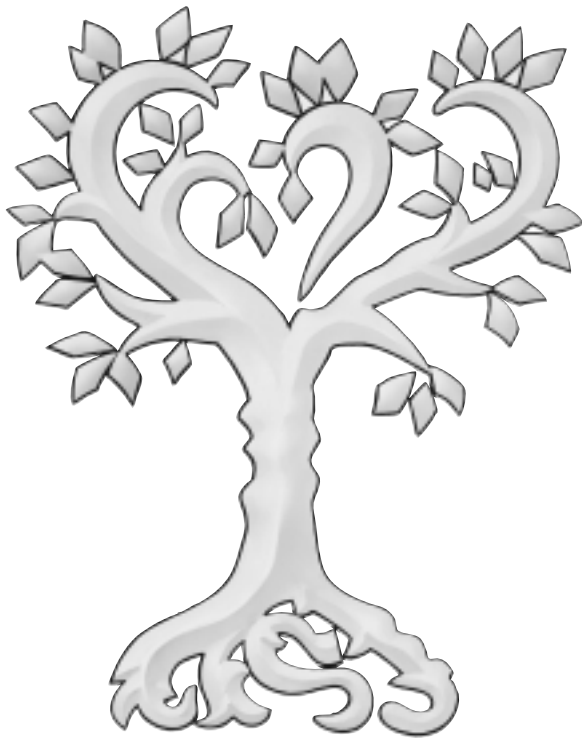

## Introduction

History shows that religion is power. The march of time and the spawning of humanity into the star-speckled void of space has done nothing to change this. If anything, the seemingly endless lands available as mankind reached the stars gave religions new strengths and new possibilities. Colonizing new lands requires brave souls focused on a collective goal. Pain, sacrifice and many hardships await life on extraterrestrial worlds. Religion often provides the strength to endure these challenges and claim a new home.

In the beginning, a single person provides the strength from which others draw. Often called mad or insane, this person dares to venture new ideas. That person endures taunts and humiliation, even punishment for such views. Whether truly blessed or simply crazy, this leader's dedication draws followers. Followers who give their body and soul to this person, this prophet, this madman.

Günther Guttman is such a man. Mad? Perhaps, but his followers do not care. His strong hand and overpowering zeal trans-

formed an obscure faith into a galactic power. Once laughed at and ridiculed, the tiny religion now envelops entire star systems. His religion is the Church of Odin. His people embrace it as the focus of their lives.

This book is their story.

## Revelation

Günther Guttman was born in the mountains of Scandinavia in Imp. 426. He led a life of little note, his unremarkable story lost in the countless billions of stories that begin and end without notice. That changed dramatically in his 29th year.

Like so many others, he found work in the spacing industry. Already 6-foot-4 and 240 pounds in his 16th year, the burley Guttman began his career as a zero-G freight worker. Lumbering through port after port, he spent years at a time in space. The money was incredible, but his life remained empty. Endless travels throughout the galaxy did little to fill that void.



# Silent Death

climb. When they met him in person, Bing regretted the invitation instantly.

Guttman was nuts. Crazy. Wacko. It wasn't just in the way he climbed seemingly with abandon and without proper safety procedures. It was in his eyes. In the way he talked. Guttman simply wasn't all there. The proof of the man's insanity became apparent when he continued up the mountain despite the storm, even after they'd lost Rahmaahd. Wild-eyed Guttman screamed over the winds, telling them they'd all die if they stayed. Everyone ignored him and he moved on alone, disappearing into the blinding snow, gone forever.

Bing never had a chance to regret his decision. The rock fall that scrapped him off the face of the mountain first struck him on the head, killing him instantly.

Günther began mountain climbing at 29, scouring the rocks of his native land and the peaks of strange planets. The embrace of pure winds swept over him like a scorching fever. Guttman's hitches grew shorter and shorter; he abandoned space's blackness for the call of the rocks and snow.

The winter of his 32nd year held the thunder of history in its icy winds. Guttman's life, and eventually billions of lives, changed forever. One incident became the cornerstone of a crushingly powerful religion.

An unexpected storm beset Guttman and his party during a dangerous winter climb. Gale-force winds ripped at the barren rock face. Hail and ice pounded the peak. Over halfway up the mountain and cut off from the ground below, the party faced a desperate situation. A vision flashed in Günther's head: to survive he must continue—he must reach the top. He warned the others, but they ignored him. To their amazement, he shrugged off the horrid weather and continued up the mountain alone.

Guttman reached the summit two days later. Hungry, frostbitten and bleeding from falls on the jagged rocks, Guttman stood atop the mountain. It was here he witnessed the vision that would change history. He stared in disbelief at the scene before him. Odin himself, surrounded by the blizzard's fury and flanked by Thor, spoke to Guttman. The old religion needed a champion, a savior.

Many non-Sigurd Archdiocese historians claim that Guttman merely suffered a hallucination that day. According to them, his experience was nothing more than a creation of his brain caused by exposure and stress. Anyone of the Faith, however, marks that day as the Revelation. Guttman ignores such debates. He witnessed the truth and will never question it.

Quaking in his boots, Guttman cried before the joyous power of the Old Gods. Infused with their spirit, he embraced their call. At that moment Guttman became the voice of Odin, speaking with a booming power of The Truth and The Way. The Church of Odin's new champion rose, screaming his mission to world.

## The Religion Grows

Guttman began preaching on Earth, but his new ministry lasted only a few months. After openly criticizing the Emperor's policies, Imperial constables arrested Guttman. Within days they passed sentence, giving Guttman a choice: five years in prison, or permanent banishment from Earth. Choosing the latter, Guttman said his good-byes and set off in search of a new home.

Guttman contacted the Archdiocese and asked permission to spread the word of Odin. While an unusual request for the isolationist Archdiocese, they allowed Guttman to preach officially as long as he filed weekly reports and contributed a weekly tithe from all donations. Guttman dutifully sent in his money, and the Archdiocese payed little attention to him until the weekly tithes grew to obscene proportions. True to form, the Archdiocese High Council left Guttman alone.

Guttman's first power base started in Chimera, a small Imperial planet well at the outer fringes of Imperial space. Chimera and neighboring planets supported a large population of Norse descendants. The Church of Odin was a small presence, but many people knew of the religion and its legends. The decision to begin on Chimera proved to be highly fortuitous, but not because of the religious base.

Chimera was the Imperial seat of Sector 103, a small, five-planet chunk of space. Poor and largely ignored, the Emperor left Sector 103's governing to Duke Blake Serevino. While life for most in Sector 103 was hard, Serevino lived well, mostly because of a steady embezzlement of public funds. Life in Sector 103 went largely unnoticed. Keeping things that way spurred the majority of Serevino's political decisions.

When Guttman began preaching on Chimera, Imperial forces ignored him. The populace, however, did not. An uncommonly powerful speaker, Guttman drew followers by the thousands. The prior ex-





istence of Church of Odin beliefs spurred his church's growth. His influence became a phenomenon: within three years he'd gained over 50,000 converts. Soon donations allowed him to buy airtime on TBD entertainment bands, and his message reached out to the other planets on Sector 103.

Guttman's speaking ability transcended his physical presence. Church of Odin ministries sprang up on neighboring Phynia and Alia 3. His fire-and-brimstone sermons stirred thousands. Imperial directors could no longer ignore his presence.

Guttman's popularity grew to the point where his legend started spreading beyond Sector 103. To Serevino, that meant possible disaster. Should the Emperor catch wind of the growing religion, he might send loyal men to investigate. Possibly investigate Serevino himself. Such attention might cost Serevino his seat as governor, or even his life. He needed to diffuse the situation, calmly and quietly. Serevino had Imperial Religious Census reports falsified. He kept the growing Church of Odin as his own little secret, all the while plotting for its downfall.

Serevino's first move was to shut down Guttman's interplanetary broadcasts. This only slowed the increase of converts. Serevino dreaded a possible mass riot should he have Guttman killed. Guttman's followers numbered over 110,000 by Imp 465—killing the man might cause civil unrest severe enough to draw the Emperor's attention. So instead, Serevino had Guttman arrested and convicted on trumped-up charges of Imperial slander.

His political ploy did not have the desired effect. Riots erupted on Chimera, Phynia and Alia 3. Over 100 people died in the fighting. In an effort to stem the rising civil unrest, Serevino had charges against Guttman dropped. But Serevino saw to it that news of the rioting never reached his Imperial superiors.

By Imp. 467, Guttman's followers numbered over one million. All five planets in Sector 103 received dozens of official requests for church permits. Serevino banned Guttman from interplanetary travel, but it was already too late. Guttman's missionar-

# The Next Millennium

The high, icy winds drove like daggers into Günther Guttman's exhausted body, yet he kept on. There was really no choice. The rest of the climbing party perched 900 feet below, praying to whatever gods they worshipped. And there were so many gods to pray to these days.

Something in his head said simply that he must either move or die. In all his days living in Finland he'd never seen a storm like this. The weather reports had projected clear skies and no winds; perfect climbing weather. The reports had been wrong, something almost unheard of these days. "Wrong" was an understatement—a storm of this magnitude seemed hard to miss. It had burst out of nowhere.

Winds peppered him with hail the size of marbles and shards of ice, tearing at his



# Silent Death

exposed skin. Some of them hit with such ferocity that they actually ripped his jacket and pants. The wind tossed him around on his safety line like a child's yo-yo. Nature bounced him off the rock face many times. Guttman bled from a dozen cuts courtesy of the jagged granite.

It seemed insanity to continue climbing in this weather, but in reality, it wasn't. The storm had blown up so quickly the party hadn't even had time to pitch tents—not that they would have been able to find purchase on the steep rock-face.

The others remained below, hoping to wait out the storm. Guttman knew they were the crazy ones, yet he couldn't explain why. Movement meant survival. If he was going to die, it would be on the way up, attacking the mountain they'd all set out

ies grew too numerous to control, and they began to spread from Sector 103 like a virus. Serevino could no longer control the upstart religion. As the Church of Odin spread into other sectors, Imperial attention would focus on Sector 103 and Serevino's embezzlement might be revealed.

So Serevino used his fortune to buy a dozen obsolete passenger liners destined for the scrap heap. He made a deal with Guttman: take the ships, free of charge, and leave Sector 103 forever on a holy pilgrimage to Midgard. Guttman immediately accepted, and poured his resources into modernizing the liners and making them space worthy. His influence continued to amaze everyone. Several of his followers were exceedingly wealthy. By the time he departed Chimera, generous donations had increased his flotilla to 27 ships, including four factory ships, one decrepit Ark, and a makeshift carrier that supported a small squadron of Night Hawks. On the first day of Imp. 469, Guttman's flotilla carried over five million pilgrims toward an icy, isolated planet in the Backnet.

## A House Reborn

Guttman's flotilla arrived in Midgard space on Imp 469:124. Sigurd Archdiocese officials regularly welcomed pilgrims in groups of ten or twenty, not five million. Guttman didn't ask for visitation rights; he wanted citizenship for all his followers. The harsh planet supported a population of just over 250 million hardy souls with a barely self-sufficient economy. Adding millions more seemed impossible. Guttman made a deal with Fjori Yngvi, the Sigurd Archdiocese Djevs (high priest).

"If my followers are not only self-sufficient," Guttman said, "but improve Midgard's economy as well, within three months, I shall lead them away with no help from the Archdiocese." The Djevs agreed, and Guttman's people landed on Midgard.

Guttman made good on his promise. Highly intelligent and highly successful people responded to his will. They brought

to Midgard priceless knowledge of manufacturing, science, research, economics and a dozen other professions. It was more than a pilgrimage to Midgard; it was the influx of new blood. New blood that metamorphosed the planet, the religion, and the government. Within three months Midgard's economy improved almost four percent.

As a reward for his amazing feat, the Djevs dubbed Guttman "Draupnir," a CoD bishop. Guttman's duties as Draupnir revolved around maintaining Midgard's well-being. Guttman, however, wanted more than the status quo: he intended to make Midgard a galactic power.

Guttman continued to sink his fortune into his personal navy. Ship-designing genius Charles Brawn orchestrated the conversion of two passenger liners into Warhounds. Guttman named them Geri and Freki, after Odin's pet wolves.

On Imp 470:023 during a meeting of the Sigurd Archdiocese High Council, Guttman introduced an expansion plan designed to bring Midgard more resources. His plan quickly gained support from the younger Draupnir, but the elder leaders derided the plan. Midgard had, after all, practiced isolationism for over 350 years. Guttman's aspirations met with immediate disfavor from the Djevs. An intense power struggle began.

In the midst of this political struggle between Guttman and the Djevs, Midgard suffered a pirate plague. Fredericé Firacéné led his pirate fleet into orbit around Midgard and began a blockade of all shipping. Far from Imperial help (and farther from any Imperial concern), Midgard suddenly began a struggle for survival. Midgard's chief import was food, with 25 percent of the food supply coming from off-world. Firacéné's blockade choked that influx to nothing.

Midgard's navy attacked the blockade. Firacéné obliterated the poorly trained and poorly Midgard forces. He immediately demanded a massive ransom and a steady tithe, or he would watch Midgard starve. As the Djevs begged for Imperial intervention, Guttman took action.



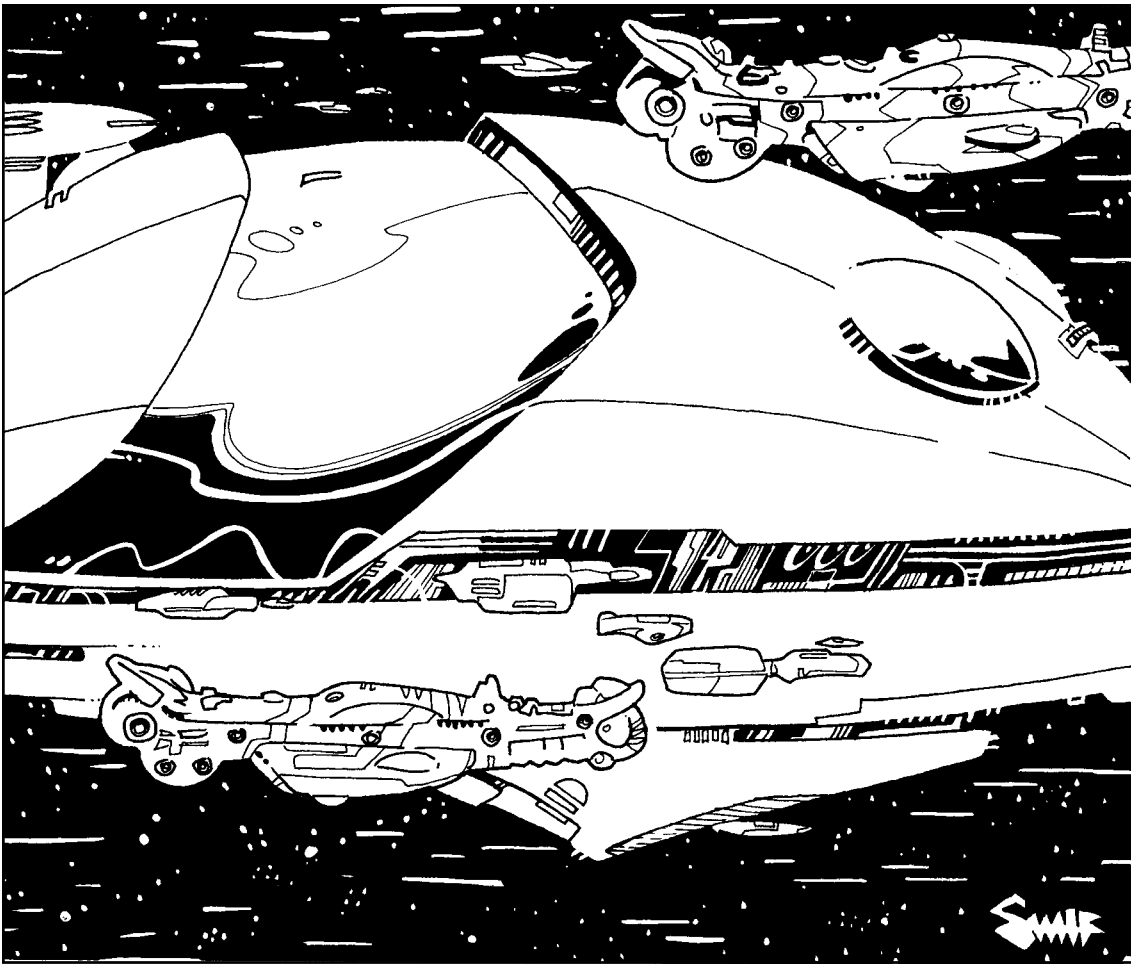

He sent Geri and Freki away from Midgard with the small carrier as escort. The ships appeared to flee the pirate scourge. Firacené's pirates moved in for an easy kill on the passenger liners. Brawn's creations, however, were more than ready for the battle. Geri and Freki demolished the pirate attack and then rushed for Firacené's flagship. A brief but furious battle destroyed the Geri, but landing parties from the Freki captured Firacené. Guttman had routed the pirates and crushed the blockade.

Ten days later, and without the High Council's permission, Guttman publicly executed Firacené as an enemy of the state. The action greatly increased Guttman's popularity on the planet. Guttman soon publicly declared his desire to be named Djevs. He refused to turn over his small navy to the High Council, stating that his ships would fight in the "best interest" of Midgard.

The implied threat was clear. The High Council faced a choice—either suffer a possible civil war with no military power, or make Guttman Djevs to keep the Archdiocese unified. They chose the latter. On Imp 471:091 the High Council named Günther Guttman the Djevs.

## Rise to Power

From that moment on, the Sigurd Archdiocese transcended its role as a tiny world of hermits and monks. Guttman opened the planet to immigration and his voice boomed throughout the cosmos; converts flocked to Midgard by the millions. All new immigrants worked on a grand vision devised by Guttman's followers. Rich in untapped resources and swollen with fresh labor, Midgard's economy soared. Within a decade of his arrival, the planet's population bulged to ten times its original size.

# The Next Millennium

to conquer. He refused to cower, waiting to see what death threw his way.

That was how he lived his life, that was his attitude about everything. Yet there was something more this time. Something called him to the mountain top. No matter what the obstacles, he had to keep climbing.

Reaching the summit gave a climber the traditional right to plant a standard in the granite. Günther Guttman planted his, then stood atop the mountain and watched as the screaming winds ripped all the standards out of the ground, one by one, and sent them sailing into the tortured sky. All the standards but his. Shivering and bleeding from a dozen cuts, Günther Guttman found the reason for





# Silent Death

the fierce storm.

A vision perhaps. Or possibly the Old Gods themselves perched on the mountain top, talking to him, telling him of destiny. When the Gods finished, Guttman sat on his knees, crying tears of joy and shouting praises into the sky. For all his life of wandering the stars, for all his meaningless existence, Günther Guttman now had a purpose. He would serve The Old Gods' will. As soon as he got off this mountain, he would begin his new mission.



Shortly after his promotion to Djevs, the gods blessed Guttman with another revelation. This revelation wasn't as pleasant as his first. This time Odin prophesied death and destruction, a holy war that would dwarf all other human wars combined. The war's name had been foretold for millennia:

Ragnarok, the war of the Gods.

The vision shattered Guttman's concept of government and religion. All aspects of government whirled with the fervor of a single-minded goal: preparing for war. The Archdiocese formed into a military organization.

Guttman poured Archdiocese resources into military growth. He focused on ships and training. As the first Brood swarms overran human civilization, many believers saw the wisdom of Guttman's ways. Donations from true believers across the galaxy poured into the Archdiocese. All of Midgard struggled with the pain of giving birth to a great war machine.

The arrival of the Sunrunners in Imp 502 was an Odinsend. Barat-Tull fell to the Brood's horrid power and the survivors drifted across the galaxy. Most of those survivors formed the Sunrunners, a mercenary band of warriors trying to pry a living from the cold, unforgiving universe. When these homeless flyers arrived in Sigurd space, they were far from the powerful military force they are today. Guttman saw a chance to fill his ranks with seasoned warriors and offered the Sunrunners a home.

Sunrunner leader Michael Bach declined the offer, preferring instead to wander the stars and prepare his people for an eventual return to Barat-Tuul. Years later Guttman realized the wisdom of Odin—the Sigurds must fight for themselves, not allow someone else to do the dirty work.

Despite the decision against residency, Midgard citizens embraced the Sunrunners. Archdiocese funds paid for repairs to their carriers and fighters. Citizens wine and fed

Sunrunner pilots, treating them as honored guests. Midgard shone as a second home away from the empty stars. The layover on Midgard was a key point in the development of the Sunrunners; it gave them a chance to bring their fleet into working order, and returned their morale.

In return for such unabashed hospitality, the Sunrunners shared their military experience. The Barat-Tuul instructors mercilessly drilled Sigurd pilots. By the time the Sunrunners set sail again in Imp 503, Sigurd crews were well-trained and ready for battle. Over the following five years, many Sigurd pilots rotated through the Sunrunner carriers, gaining invaluable combat experience. To this day Sigurds and Sunrunners hold each other in very high regard.

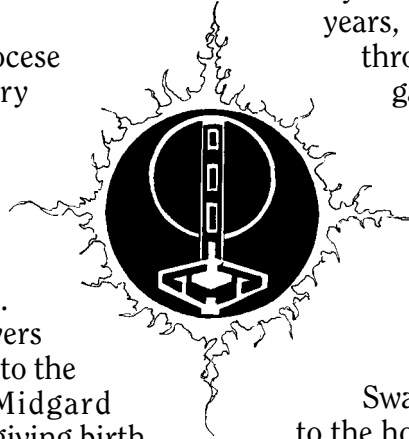

## The Grubs

Swarm 701 was small compared to the hordes that plagued the Imperial Core after Modestinus' ill-fated Doomsday Device. Midgard sat quite literally in the middle of nowhere, far from any other populated sector. Initial Swarms passed over the planet. In the big wave, however, the Brood ignored no one.

Before reaching Midgard, Swarm 701 had already polished off houses of the Ewanoma Cluster and Deep Hosk Congress. Swarm 701 suffered losses in those two campaigns and was without support from other Swarms, yet they still outnumbered the warriors of Midgard 4-to-1. The highly trained Sigurd fighter wings dug in against the Swarm, and conflict ended in three battles.

## Thor's Hammer

The first fighter wing to rise to the challenge, and the most famous, centered on the carrier Thor. Packed with Sunrunner-trained and combat-tested pilots, Wing T-

01, known as Thor's Hammer, led two other wings out to meet the challenge. Morale ran impossibly high in the wing, for Guttman himself led them into battle. He sat on the bridge of Midgard's first domestically produced Warhound, a massive Longboat named Hlidskjál, meaning "Odin's Watchtower."

Unlike most pilots of the various Imperial houses, many Sigurd fighter jocks flew several campaigns against Grubs during maneuvers with the Sunrunners. That experience proved to be vital. The Brood immediately moved to wipe out the carrier group and its escorts. Thor's Hammer forced Swarm 701 back, protecting the carrier, but at great losses—the attack completely wiped out Wing T-02 and reduced Wing T-03 to just five working ships. Swarm 701 barely paused before re-grouping and pressing their sudden advantage, committing all reserves to the fray. The Swarm apparently wanted the Thor obliterated.

## The Loki Strategy

The Midgardians fought well, demonstrating clear superiority in one-on-one encounters. Apparently the Swarm sought to outweigh the Sigurd skill with numerical superiority. Swarm 701 moved towards the Thor's battle group and left almost no reserves to protect the mothership. While a large fighter element rose from the planet to aid the Thor, it would arrive too late. The Swarm launched the attack, committing over 90 percent of its remaining fighters.

As Swarm 701 set out to overrun the Thor, Captain Melnir Hedin jumped-down the Guttman less than 1,000 Kilometers from the massive Nightbrood battle-pod. The Sigurd fighter launched with the momentum of the jump-down, a trick Hedin learned from his days as a Sunrunner fighter-jock. Wings G-01, G-02 and G-03 bore down on the Swarm mother ship just as the forward Grub fighters engaged Thor's Hammer. Facing only a handful of Mantas, the Sigurd forces quickly overwhelmed the swarm's primary ships.

# The Next Millennium

The wind died down and the storm abated. Later the sun appeared, illuminating the beauty of the mountain top. The view spread out before him, but now he could see with more than just his eyes. He could see with his mind, and his mind knew the future of the new religion. He started down the mountain—despite his wounds, exposure and exhaustion.

There was work to be done.

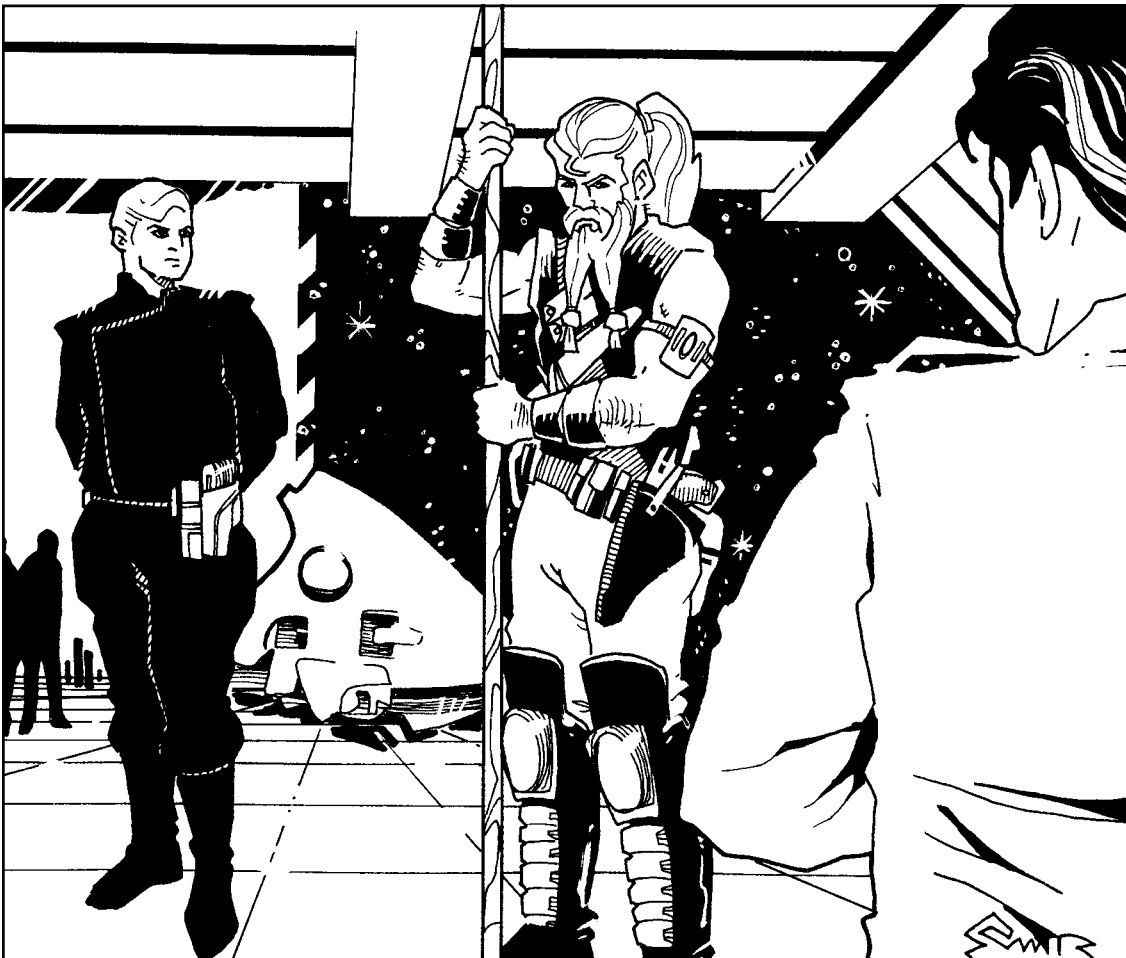

# Silent Death

Swarm fighters immediately raced back to defend the primary ships, but arrived too late. Hedin's fighters left it a ravaged hulk, a shell spilling Grubs and green blood into the dark void—but they hadn't destroyed it. The remaining Swarm fighters rallied around the ship, flying picket patrols as they began repairing the mother ship.

Yet another Brood mistake, and yet another tactic played by the crafty Midgardians. The force rising from Midgard had time to regroup on the Thor. Led by the remaining elements of Thor's Hammer, the fresh fighters bore down on the mother ship and the remaining Swarm element. The fighters of the Guttman also re-committed to the fray.

The pincer movement caught the Grub force dead center. In a matter of hours, the Midgardians obliterated the Grubs. Not a single fighter remained. With the fighters gone, the Hlidskjál moved in and decimated the crippled mother ship, vaporizing every last trace of the Nightbrood. With only two carriers, six full wings of fighters, and a handful of Warhounds, Midgard obliterated an entire Grub Swarm.

## War Heroes

Güttman himself re-christened the Guttman the Ymir for the giant's role it had played in the battle. The fighter wing that led the charge that destroyed several primary ships earned the nick-name Loki's Kids. Guttman canonized Hedin for his daring jump-down. St. Hedin remains a national hero to this day.

The re-naming of the carrier Ymir created an odd tradition for the Midgardians. Every carrier since is named the Guttman, and keeps that name until it earns its own in battle. This also ensures that the newest, strongest carrier bears the label Guttman.

Through guile, preparation and vicious fighting skills, the tiny house of Sigurd Archdiocese, consisting of only one planet and seven fighter wings, wiped out an entire Swarm. The Midgardians racked up a 3-to-1 kill ratio over the Nightbrood, all because Guttman had prepared for battle from day one. Although the Empire crumbled and communication became difficult, Guttman's legend grew.

## Refugee Planets

While the Archdiocese wasn't the only house in that sector fighting the Brood, they were the only government left intact. The Hatchlings raged through the sector destroying everything in its path. Everything except the Sigurd Archdiocese. The Archdiocese stood as the sole remaining power in several sectors. The doorway to expansion opened wide.

Whether it was the growing legend of Guttman, the promise of financial and military support in a ravaged sector, or the implied threat of three fully armed carriers (as the newly commissioned Guttman joined the navy), planets fell into line. It was a simple choice for planets and systems demolished by the Nightbrood—join the Archdiocese or stand alone and vulnerable in a dangerous time.

## Deep Hosk Congress

The destruction of the Deep Hosk Congress left several planets open for reclamation. As the closest military power, the Archdiocese claimed them all without contest. Simbulia and Reiger 6, living jewels of the Deep Hosk Congress, became protectorates of Midgard. While the Brood mysteriously left the Reiger system mostly untouched, the rest of the Congress succumbed to the alien fury. Simbulia and Reiger 6 could not defend themselves, without the Congress' protection. Both planets accepted the Archdiocese' protectorate status the day it was offered.

## Ewanoma Cluster

The Nightbrood nearly obliterated the Ewanoma Cluster. Once a booming Imperial power boasting 17 populated planets, human life now only existed on three of the former House's worlds. Agomio, an agrarian planet known mostly for its exotic woods, avoided conflict with all but the fringes of Swarm 701. The heavy industrial centers of Kamchatka and New Denmark, however, felt the full brunt of the Swarm's wrath. Kamchatka sat ravaged and dying. New Denmark was little more than a rock



with an atmosphere; less than 250,000 people remained from a population that once numbered three billion. All three planets accepted protectorate status when it was offered.

Kamchatka originally functioned as a Midgard Consulate colony (see Timeline). It was the House's first attempt at colonization. In the Early days of the empire the Consulate maintained a booming economy. While the colony initially flourished, the Haas-Greebold Holocaust (see timeline) left Kamchatka without support. Cut off from help and decades away from self-sufficiency, Kamchatka faced despair in Imp 137. The newly isolationist Archdiocese Government sold the colony, which the Ewanoma Cluster government bought for a song. Midgard citizens considered the re-claiming of Kamchatka in AL 1 a powerful omen and yet another symbol of Guttman's power.

## House Shantac

Remnants of House Shantac became the biggest windfall for the Sigurd Archdiocese. Within Sigurd's sector, House Shantac sat closest to the Imperial Core. After demolishing Swarm 701, the Thor and the Ymir set sail for House Shantac, which at that time struggled for its life against Swarm 1019. The Brood reduced House Shantac's original population of 25 billion spanning eight worlds to a mere 2.6 billion on two planets: Yak-Tarull and Yak-Shindichi. The remnants of House Shantac's military centered on the defense of Yak-Shindichi, the capitol.

Highly experienced, well trained and armed to the hilt with fully functional ships, Sigurd wings battered Swarm 1019. Just as the last of House Shantac's carriers fell to the Swarm, forces from Thor and Ymir rushed in to defend the exposed planets. Considering how easily the Sigurds won, the battle's outcome seemed pre-ordained (again Archdiocese forces faced a weakened Brood foe, and again they won

hands-down).

With no remaining forces to speak of, House Shantac faced the same situation as many others ravaged by the Brood. The Sigurd offer was black and white: join as a protectorate, subject to all the laws of the Archdiocese, or stand alone. A democratic vote spelled the fate of House Shantac; the government disbanded as both planets entered into protectorate status.

Neither planet suffered a great deal of damage. Both enjoyed solid industrial development and factory output, and both boasted a highly educated work force. With the Archdiocese government's stability, Yak-Tarull and Yak-Shindichi quickly rebuilt their pre-Brood economies.

## Sector Protectors

The Archdiocese's expansion brought new pressures to bear on the military. Defending a single planet required little in the way of logistics; defending eight was a comparative nightmare. Guttman found his forces spread thin, a problem that demanded a simple and familiar answer: military expansion. Over 30 percent of the Archdiocese economy began to produce or support new ships.

Midgardians worked constantly to provide defenses and structure for these wayward planets. The powers of the universe laughed at the 61-year-old Guttman for taking on New Denmark and Kamchatka. Naysayers claimed that the planets should be abandoned, that rebuilding them would cost far too much. Guttman proved the critics wrong.

Most survivors viewed their rescue as a sign from the gods. Mass conversions swelled the Church of Odin's faithful ranks. The dedicated followers' work ethic built the ravaged planets back up from ground-zero. In short, the entire sector saw only eight worlds survive the Brood invasion: those eight make up the core of Archdiocese power.

# The Next Millennium

## Missionary Man

The Hound's hatch opened with the angry hiss of stale, pressurized air that dissipated into the landing bay's purified atmosphere. Jory Keunesson waited impatiently for the ramp that rolled up the cockpit. He grabbed his few meager belongings from behind the fighter's small seat. He immediately strapped on his blaster, clipped his combat knife onto his chest webbing, shoved another sheathed blade into his boot, and pulled out his holy walking stick; a halberd with a foot-long blade gleaming menacingly from the top.

Across the sprawling bay Claus Wolfran's chest stuck out proudly, which only accentuated the oil stains on his coveralls. Promoted to Sergeant in command of the Maelstrom's launch



# Silent Death

bay only yesterday, he stood shoulder-to-shoulder with Captain Tayedor Bach. The two men waited—together—to greet the new Sigurd Missionary on his arrival to the Sunrunner carrier. As the crew boss of the landing bay, part of the tradition held that Claus greet the missionary and testify that the fighter would be well cared for. Wolfran realized that he'd seen over 100 missionaries arrive in his day, but he'd always been so busy that he'd never watched them after they'd landed.

"Geeze-o-peets, Sir," Wolfran said quietly, already feeling at ease with the relaxed Captain Bach. "Why is he arming himself like that? Doesn't he know he can trust us?"

"He knows no such thing," Captain Bach answered with a smile. They watched the missionary descend



## Other Planets

Aside from the main planets of the Archdiocese, several smaller worlds provide raw resources and economic support. All of these minor worlds are recent colonization efforts. The Brood wiped the majority of the sector clean of life, leaving few fertile planets. Niflheim, Jötunheim and Hverggldmir all sport populations under one billion. Jdalerbru is undergoing a massive terra forming project, which should see completion in the next 20-30 years. Additional terra forming projects underway on Panthalassa and Laurentia are mothballed due to political tensions with House Red Star (see below). Life is hard on all of these planets, but their conversion to productive members of the Sigurd Archdiocese progresses at a steady rate.

## Gunther Guttman

Guttman's journey to leader of the powerful Sigurd Archdiocese was long and strange. It began on a forgotten mountain top and moved, aided by several "miracles," to a desolate, frozen planet on the outskirts

of known space. In his lifetime Guttman has propelled a small House into one of the most powerful religions in Terran space, defeated the Nightbrood, and rescued billions from certain disaster.

The Sovereign of a massive House and the Patriarch of the Terran space's largest religion, Guttman controls more humans than many realize. He constantly preaches of Ragnarok, the Holy War. Since the first days of his ministry, he preached that the Beastmen would come, the Serpent would strike, and humanity would fight for its very existence. Many believed his word without question while most laughed and called him a madman.

When the Prometheans arrived, many human governments embraced the visitors. The Sigurd Archdiocese did not. True to his form, Guttman apparently predicted the arrival of these new creatures. The Promethean's resemblance to his prophecies seems more than coincidental, and is rather unnerving for the billions of people who heard his word and ignored the call. The Promethean's physical appearance has produced more converts than any other event in Sigurd's short but illustrious history.

## Political Relations

Guttman's "Promethean Policy" shapes the Archdiocese's relations with the other major houses. The Sigurds treat coldly any minor house that sides with either the Draconians or the Primates. A clear message rings loudly through the galaxy: if hostilities flare up, Promethean allies are Sigurd's enemies.

The Sigurd's staunch, inflexible attitude towards the Prometheans fuel hostilities with other major houses. The Archdiocese doesn't have the liberty of canceling diplomatic relations with any house at this time without causing all-out war. Any large-scale conflict would surely spur a Nightbrood uprising—any house that forces conflict stands alone against the other eleven. Guttman realizes this and handles relations accordingly. But just because the Sigurds can't be all-out enemies with Promethean sympathizers doesn't mean they have to be friends.

To truly understand the Sigurd's diplomatic policies, one must understand their religious views. All of humanity is inherently good, but can turn to evil. The Sigurd faith holds strongly that humans need guidance lest they fall under the pull of Loki and his minions from Hel. Because of this, many Archdiocese "official" political stances are highly contingent on any system's culture, beliefs or associations with the Prometheans. Any house that conspires with this evil is derided, and any system that casts away the Prometheans will quickly find itself a new friend in the Archdiocese government.

## House Colos

House Colos is a proud warrior state seduced by the Lizards. The Sigurd Archdiocese considers House Colos the worst Draconian sympathizer. Colosians did, after all, introduce the demonic Lizard scourge into Terran space (SD:TNM pp. 20-21). The fact that the Sigurds hold these views publicly, and the fact that the two houses share a border, make for tense times. Add to the mix a running long-running border dispute and the potential for violence reigns high.

Border skirmishes with House Colos grow more common every month. Right now the encounters seldom involve more than a pair of patrol ships, but larger fights of up to five ships a side and even full squadron encounters occasionally erupt. Both governments use the border as a testing zone for new ship designs, and pilots gain invaluable combat experience in the disputed area.

Following the Brood's defeat, House Colos grabbed several planets that sat within the borders of the former House Shantac. The Archdiocese claims ownership of all planets from that house. Neither side wavers from their claims. The fact that the planets involved are small, lifeless hulks bears little impact on either government.

A inter-galactic team of neutral scientists agreed upon by both houses works to hammer out acceptable borders. To complicate the matter, a massive asteroid cluster is hurtling through the disputed area. The cluster is long, and its drift through the sector will take decades. Initial long-range surveys of the belt show it to be very rich in mineral wealth. Both sides claim sole rights to the windfall.

While both houses say they expect this phenomenon and will deal with it peacefully, the Kashmere Commonwealth, among others, already prepares to sell weapons and supplies to both sides.

## House Red Star

Until the coming of the Prometheans, the Sigurd Archdiocese and House Red Star shared many common traits. Both are re-born religions, free of persecution at the hands of the Empire and old Earth governments. Both houses are hungry for success, and are populated with dedicated individuals.

House Red Star enjoyed a lucrative business helping the Archdiocese re-build Reiger 6 and New Denmark. Red Star's engineers also tamed Niflheim and Jötunheim. As the Archdiocese continued to expand and develop potentially hospitable planets, House Red Star looked to reap untold fortunes from terra forming projects.

The Primates, however, changed everything. Red Star has only a tentative alliance with the Primates. Even a minor alliance with the Primates, however, is enough to draw the derision of the Sigurd Archdiocese. To the Sigurds, House Red Star allies itself with the Beastmen, the literal representation of the Devil. You can't have a "tentative" or "minor" deal with Beastmen—you are either with them or against them.

True to those views, the Sigurd Archdiocese scaled back its business with Red Star, allowing contractors to finish up their current project, the planet known as Jdalerbru. Sigurd canceled two other running terra forming projects (Panthalassa and Laurentia). For the moment Red Star is taking their losses and fighting a political battle with the Sigurd government, hoping to change its policies. Such hopes seem ill-fated, however, as most of the galaxy knows damn well that those terra forming projects are mothballed until House Red Star rejects the Primates. The situation generates tension amongst Red Star and the Sigurd Archdiocese. The situation affects millions of Red Star lives. Short tempers have already erupted into minor skirmishes.

# The Next Millennium

the ramp; his eyes glanced back and forth, looking for danger or perhaps waiting for a challenging stare from one of the dock crew.

"He'll know he's safe when he sees it for himself," the Captain continued. "That's the way they are, and until then he'll be armed to the teeth no matter what anybody tells him. By the way, don't ask him for his weapon at any time. We make exceptions to the launch-bay regulations for the missionaries."

"Sir!" Wolfran exclaimed, trying to keep respect in his voice but already slipping into the unforgiving tone of a man now responsible for the safety of the Maelstrom's fighters and ammo. "We can't have him coming into the bay with an armed blaster! You know how pilots can lose their temper over their ship."



# Silent Death

“Don’t worry about it, Wolfran, that’s an order,” Bach said quietly. He didn’t have to yell; his reputation did all the talking. “I’ve never seen one of these missionaries draw a firearm.” The missionary pilot reached the flight deck and walked forward, sharp eyes still flashing everywhere. Bach stepped forward to greet him.

“It’s OK, he’s not going to fire it,” Bach added with a small smile. “If he’s got a problem with how you handle his ship, he won’t use the blaster. See that big knife on his chest? That’s all they ever use. That or their fists. So you’ve got nothing to worry about.”

Wolfran swallowed hard and stared at the 12" blade strapped to the big pilot’s web gear. He also looked at the man’s hands, already balled up into fists the size of an

## House Tokugawa

Before the coming of the Primates, House Tokugawa and Sigurd Archdiocese enjoyed warm relations. The Tokugawans did not crumble under the intense pressure of Brood attacks, but instead transcended their peaceful existence and found a way to survive. The main focal point of the two Houses strong ties hinged on the Archdiocese’s vocal stance regarding Brood-decimated Tokugawan planets.

Guttman himself spoke out in favor of the Tokugawans retaining the rights to the planets controlled before the Brood incursion. Guttman’s view was clear: House Tokugawa fought the Brood and won, the government remained intact, and therefore should keep its rightful property. Any planet the Sigurd Archdiocese claimed in the wake of the Brood assault satisfied three criteria; 1) The planet’s government was destroyed or unable to protect its assets, 2) The planet could not defend itself against pirates and other attackers, and 3) The planet’s remaining survivors accepted Guttman’s invitation to join the Archdiocese.

Because of this, Guttman remains adamant that Tokugawan lands should rest in Tokugawan control, a point of much contention in the post-Brood days (see SD:TNM pp. 24-25). The Tokugawans did not take this support for granted. They solidified a firm friendship with Guttman and the Archdiocese.

That friendship, however, disintegrated when the Tokugawans embraced the Primates. On official levels, Sigurd ambassadors campaign hard to persuade the Tokugawans to cast away the Beastmen, while Archdiocese priests shout the message of evil to all Tokugawan citizens.

The Tokugawans are reluctant to make an enemy of the fanatic and supportive Sigurd government. They will not, however, compromise their alliance with the Primates because of religious fanaticism. Tokugawa sadly prepares defensive strategies against possible Sigurd attacks.

## Yoko-Shan Warworld

There is one House above all others that the Sigurds have respected for decades: the Yoko-Shan Warworld. From living by a warrior’s code of honor very similar to the Church of Odin, to leading the galaxy by example and always remaining steadfast in their fair and just beliefs, the Yoko-Shans in many ways mirror the Sigurds.

Before the coming of the Brood, the Yoko-Shans were the most feared mercenaries in known space (*SD:TNM* pp. 26-27). At one time the Warworld held the power to easily wipe out the Archdiocese. This fact bears historical significance, as an unknown faction offered Makhtar Mutumbe, leader of the Warworld, an exorbitant amount of money to do just that.

Mutumbe declined the contract. He wanted nothing to do with fighting a fanatical, desperate government or sending his men to fly against an enemy that gladly battles to the death. Mutumbe’s foresight saw a Sigurd house gearing up for indefinite military conflict; he had no wish to earn the Warworld a permanent and fanatical enemy. Ironically, popular Midgardian belief holds that Mutumbe declined the contract because he viewed the Sigurds as an honorable people.

To this day it remains unknown who fronted the money; only Hibernian Intelligence Agency spies know the details of the offer. The Warworld refuses to reveal any information regarding contracts, whether they be accepted or not. Due to his refusal of the contract, citizens of the Archdiocese hold the Yoko-Shan government and it’s people in high esteem. Midgard still recognizes Mutumbe’s birthday as a national holiday. This regard tempers the Sigurd reaction to Yoko-Shan’s excessive dealings with the Primates. On a system-wide level, it is almost as if the Sigurds can’t bring themselves to believe that the honorable warriors of the Yoko-Shan Warworld would befriend the Beastmen. Guttman himself is said to be suffering severe depression over the Yoko-Shan’s dealings with evil.



The Sigurds show a rare trait towards Yoko-Shan: patience. Perhaps the Warworld will snap out of the evil spell cast upon them by Loki and his Beastmen. Sigurd ambassadors lobby heavily in the Yoko-Shan congress, but the Warworld is relatively free of Archdiocese influence. Guttman feels in his soul that the system is slipping away from the light and sliding into darkness.

His benevolent patience will last only so long.

## **Kashmere Commonwealth**

Food, clothing, fuel, supplies, weapons, ships—whatever is needed, the Kashmere Commonwealth has always been there.

In Imp. 432, when the tiny Midgard colonists were desperate for supplies to continue their holy mission, the Commonwealth was there.

In Imp. 470, when pirate trouble shut down shipping lanes to Midgard, the Commonwealth braved the danger to deliver supplies of desperately-needed food.

In Imp. 512, when the galaxy roared in chaos at the destruction of the Imperial Core, the Commonwealth managed to keep vital shipping lanes open.

Always have the good people of the Commonwealth traded with the Sigurd Archdiocese, always have they been happy to take Midgard's plentiful raw ores in exchange for all manner of goods. To this day, the Commonwealth remains the Archdiocese's number-one trading partner, the chief importer of Midgard's ores, the chief exporter to Sigurd planets.

With that track record, most systems could easily turn a blind eye to the Commonwealth's business dealings with both the Beastmen and the Serpents. It would be easy for most systems, but not

for the Sigurd Archdiocese.

The Archdiocese would not have survived without the Commonwealth's support. The Sigurds believe the Prometheans not could enjoy their successful presence in Terran space if not for that same trade. This caused Archdiocese opinion to take a turn for the worse.

Trade continues, but at a fraction of its former level. The Sigurd government pours endless resources into developing self-sufficiency. As the galaxy takes sides with evil, isolationism can't be far away. The Archdiocese prepares for that eventuality. The Sigurds come closer and closer to that goal every year, and business with the Commonwealth drops correspondingly. The Commonwealth government isn't happy about this, either on an official or unofficial level.

There is no proof that the Commonwealth financially backs successful raids on Sigurd mining operations, Andrium refineries or communications platforms. All of these things are main centers of Sigurd/Commonwealth trade. With each raid that sets back the Sigurd's goals of self-sufficiency, trade sparks up again, albeit briefly.

Whether these suspicions are true or not is unknown. What matters isn't the truth, but what the Sigurd fighter patrols believe. Several cases of "mistaken identity" have already occurred, and at least two Kashmere caravans flew through "training zones" and came under fire. Such skirmishes escalate monthly, and if the Sigurds ever achieve self-sufficiency and can cast away those who would trade with the Devil himself, there will be many, many more.

# The Next Millennium

autocannon magazine. Wolfran then looked up into the man's face. The missionary's eyes had stopped flickering around and bore straight into his own. The pilot easily identified Wolfran as the man in charge of fighter maintenance, and it looked like the missionary had a thing or two to say. Wolfran swallowed hard again as he and his captain stopped and saluted. Perhaps this job wasn't going to be as fun as he thought.





## Hibernian Freehold

The Sigurd Archdiocese isn't the only representation of the Church of Odin. Other Archdioceses flourish in areas other than the Sigurd's. The next two biggest factions of the Church of Odin are the Paradise Archdiocese (listed below) and the Hibernian Archdiocese.

In the later years of the Empire, Hibernia threw its doors wide open to immigration. The Sigurds saw an opportunity to make large inroads on another population. Thousands of Odin's followers ventured into Hibernian space, spouting rhetoric and prophecy. Perhaps the most open-minded people in the universe, the Hibernians listened carefully to the message brought by these immigrants. Hibernians, however, were far too educated to buy into the hard-line beliefs of the Church of Odin. While the practices of the Church seemed far too conservative for the Hibernians, much of the message made the leap between cultures.

The result was a phenomenon psychologists still hope to explain. Many Hibernians seized the religion and molded it into a new form, a form that fit a more open-minded mentality. They worship the Old Gods, but in a much different way. They largely ignore the steadfast traditionalism of Midgard and her daughter planets. The Hibernian Archdiocese sports a large and diverse membership, but isn't large enough to be a true factor in Hibernian government. A few traditional Sigurd churches remain on Hibernian worlds, but are vastly outnumbered by the more refined Hibernian Archdiocese houses of worship.

While the splinter group remains closely tied to the parent church, it focuses more on education than military might and more on the power of thought than the power of muscle. The one thing the two groups share, however, is the clear-cut view that the Prometheans are evil.

The Sigurd Archdiocese considers the Hibernian Freehold one of humanity's great hopes. While most humans side with either the Lizards or the Beastmen or both, the Freehold refuses an alliance with either Promethean faction. This independence from "evil" gives the Hibernians great respect among Sigurd peoples and government.

The fact that the Hibernian Freehold rejected any dealings with the Prometheans gives it favored-nation status with the Sigurd Archdiocese. The Sigurd government does everything it can to aid the Hibernian Freehold's attempt to claw out from a severe recession. While the Hibernian government is slow to claim an official alliance with the radical Sigurds, they welcome Sigurd help and trade.

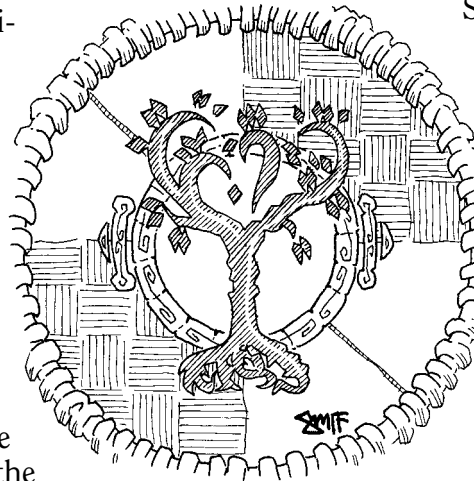

## ASP Technocracy

The Enemy. Traitors. Spawn of Loki. The corpse-men. These are all words used by the Midgardians to describe members of the ASP Technocracy (at least the names that can be printed in this book). There is, however, one name that all Midgardians commonly use to describe not only the populace of the ASP Technocracy, but the entire house as well.

That name is the Children of Muspell.

According to Sigurd prophecies of Ragnarok (the battle that marks the end of the Old Gods if not the end of humanity), Loki rides forth from Hel on the great battleship Nagflar, the ship full of corpse-men who will fight on Loki's behalf. Up from Hel they rise, and are joined by the Children of Muspell, the traitorous mass of humanity that choose Loki's evil over Odin's good.

In the eyes of Guttman, there is no question that these prophecies foretold the of ASPers joining blindly with the Draconians. ASP gives the Serpents valuable Terran tech-



nology and teaches the Serpent the ways of Terran man. The Draconians guard the ASPers, their little human traitors, in exchange for the secrets that will bring mankind down.

While this may sound like outlandish, wild ramblings of a fanatic, it is the official stance of the Sigurd Government. They have no ties with the ASP Technocracy, and refuse to recognize them as an independent government. The Sigurds consider the Technocracy a Draconian protectorate. According to this definition, the Draconians control territory in Terran space, which makes that space and anyone in it fair game to all humanity.

While not at war, Sigurd pilots have blanket permission to fire upon ASP vessels whenever see fit. As most pilots are fanatical Church of Odin followers and consider ASPers pure evil, they “see fit” quite often.

## DataSphere

While the ASP Technocracy is known as the Children of Muspell, the DataSphere holds an even lower status. In this place no living person walks. It is a place of machines and death, devoid of holy life.

To the Sigurds, the DataSphere is Hel itself. It is even located where Hel should be, right next to the Imperial Core, where Odin’s vengeance slammed down on the unbelievers. One important note, however, is that the Archdiocese religion doesn’t necessarily consider Hel an evil place unto itself; just the place where evil dwells. There is currently a good deal of internal debate about the AIs that populate the DataSphere. Some prophets say Odin created the AIs and they can’t be defined as evil simply because they aren’t human. This view gained support until the DataSphere’s alliance with the Draconians.

Now the prophets that speak the loudest are those who claim the AIs are the embodiment of the mythical Fenriswolf, creatures who are waiting for Ragnarok to begin so they can charge forth across Bifröst Bridge to attack Odin himself. The current interpretation of this belief holds that the DataSphere will be responsible for High Priest Guttman’s death when the final conflict erupts.

Due to Archdiocese beliefs, there is little trade or talk between the DataSphere and the Sigurds. The AIs constantly lobby the



Sigurd government to open up lines of communication. The AIs are fascinated with humanity and consider it a loss to not learn more of the Church of Odin. While trigger-happy Sigurd pilots may fire on DataSphere vessels from time to time, DataSphere’s pilots (both android and program-clone) will retreat unless they must fight to protect a shipment, stay in a specified area to complete a mission, or the Sigurd planes have flown past DataSphere borders (and only then if the Sigurd jocks force the conflict).

## Unkulunkulu Archipelago

Average members of the Sigurd Archdiocese despise hold the Unkulunkulu Archipelago. This system’s people are lawless, lazy, disorganized and follow whatever pleasures their hedonistic lifestyles allow. To the Sigurd religion, which stresses discipline, self-control, self-sacrifice and the strict order of the church-state, the Unkulus are little more than heathens ripe for conversion.

# The Next Millennium

## Pilgrimage

The Shyrak Shuttle slowly touched down on the landing field. Its retro-rockets blew up billowing clouds of fine, powdery snow. The passengers unhooked from their safety harnesses, eager to see the surface of Midgard for the first time.

The door opened and cold air slapped Yazmin in the face. Her breath caught in her throat and she squinted her eyes against the icy wind. She put her hand on Corky’s shoulder to steady herself going down the ramp.

“It’s more beautiful than I’d imagined,” Corky whispered in a tone of reverence, a tone echoed by humble comments from the rest of the pilgrims. Yazmin managed to wipe the water from her eyes. Her hand shielded her face from the wind. The landing field was



# Silent Death

nestled deep in the Ymir Mountains. Impossibly tall peaks stretched up all around, glowing white, spotted with the black and gray of the rocks beneath the snow. Her breath caught in her throat again, this time not from the cold.

She was trying hard to learn the religion. She'd promised Corky the day their crippled Beta Fort broke out of hyperspace and headed for the gravity well of Aloha. The two of them had sat in the crippled ship, facing the certain fiery death of re-entry, when she'd asked Corky to include her in his prayers to Odin. Now she was living up to her word, joining her comrade in pilgrimage to the holy land of Midgard. The religion, so far, held no mystique for her. She'd listened to three Sigurd priests during the journey, but their intense words rang empty and more than a little radical.



The Unkulus, however do have one trait that the Sigurds find endearing: refusal to ally with either the Beastmen or the Serpents. This makes the system a prime target for missionaries—if the Sigurds can convert the Unkulus before the coming of Ragnarok, they gain an ally in the final war.

As one can imagine, many Sigurds would love to travel to the paradise-like planets of the Archipelago and preach the prophecies of Guttman. The Church knows this; only missionaries proven through great self-sacrifice and desolate travels may voyage to the paradise planets. The Church wants missionaries to preach and convert, not surf and sail.

While the Archdiocese steers a steady stream of missionaries to the Archipelago, the Unkulunkulu citizens are mostly ambivalent to the messages of conversion. The wild, undisciplined Unkulus care little for the impossibly strict standards of the Sigurds. The Church of Odin is, however, making inroads, but via an unexpected vehicle. Claus Straussenmacht, one of the first Sigurd missionaries in Unkulunkulu space, is now a citizen of the Archipelago. He founded the Paradise Archdiocese.

Straussenmacht's church embodies the spirit of the region's people. Very free-wheeling and open, the Paradise Archdiocese holds none of the strict Sigurd codes. Twenty years after it's founding, the two religions seem barely related. The Paradise Archdiocese pays tribute to the Sigurd Archdiocese and is an active member in the Church of Odin, but remains small and has no impact on the Unkulunkulu government.

Distance between the two houses makes trade difficult, but not impossible. The governments are among the few greater powers who have not lined up on either side of the Promethean War. This has led to increased trade, particularly in military training. The Unkulunkulu and Sigurd pilots spend time in mock-dog fighting drills, honing skills that mean the difference between life and death when real ammo flies. The Unkulunkulu government won't publicly declare an alliance with anyone, particularly not the radical Sigurds. But make no mistake—if trouble erupts in the Archipelago, Sigurd carriers will be there to aid in the conflict.

## Q'raj Void Protectorate

It is a state of desolate planets, burning suns, lifeless deserts and wintry wastelands. For most of the Q'raj Void Protectorate, there is little in the way of creature comforts—only the strong, dedicated and hard-working survive here. Missionaries of the Sigurd Archdiocese would feel right at home, if they were allowed to land.

In AL 4:110, the government banned all Sigurd missionaries from entering Q'raj space. From AL 2 through AL 4, Sigurd missionaries made inroads on the desolate Q'raj planets. While the Sigurd Archdiocese would never compete with the native religions, church officials planned on a strong presence as the backbone of an alliance. It looked positive until the Q'raj government embraced the Beastmen.

To the few thousand native Church of Odin members this alliance meant only one thing—that evil permeated the government. This feeling spurred a rash of terrorism. Sigurd missionaries warned against such actions, but it was already too late. The Q'raj government declared all Church of Odin activities seditious. Q'raj officials banished missionaries and put many native Church of Odin followers to death.

These actions drove the native Church of Odin followers underground. Only the truly fanatical now follow the religion. These fanatics make up a handful of terrorist groups that plague Q'raj culture. The main terrorist group, the Vidarr, are a vicious bunch that shows mercy for no one. Unfounded rumors hold that Jonass Brawn, grandson of Charles Brawn of Brawn Factories (see new ships) secretly funds the Vidarr.

The two systems are close in proximity. Long-range patrols from carriers occasionally cross paths. Most of these fly-bys are friendly, often with exchanges of greetings rather than pulse-lasers. As terrorism increases, however, more Q'Rajies feel its sting. Skirmishes erupt from time to time as Q'raj pilots who have lost loved ones to terrorism strike out in frustration at the only target they can find. Sigurd pilots, never one to turn down a fight, reply in kind. Both militaries are cracking down on this behavior.

# The Next Millennium

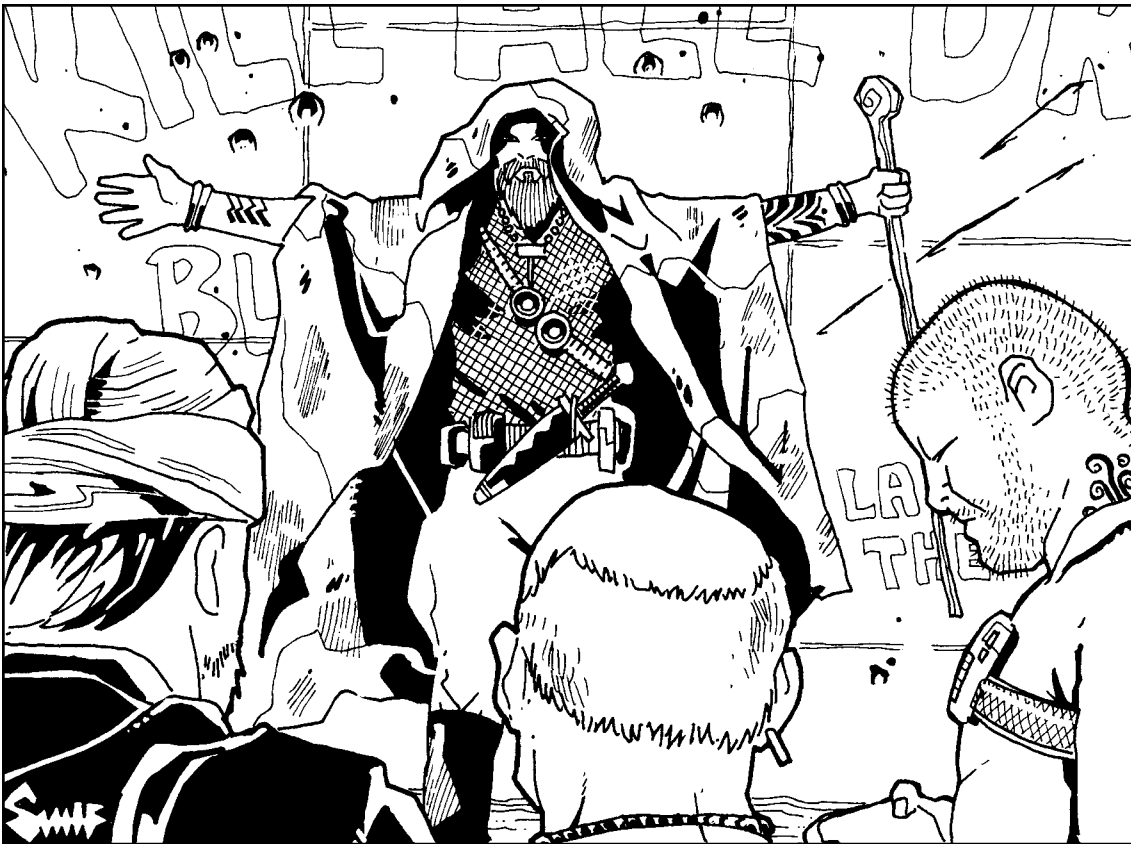

## Luches Utopia

People of Luches Utopia lead a hard life, much worse than even the stalwart people of the Q'raj Void Protectorate. Oppressed and downtrodden, Utopians suffer at the hands of the cruel, but efficient, Luches dictatorial government. It is a place where the annual suicide percentage is in double-digits, a place where hope hopped on the last transport out of the system and made the translight jump to somewhere else.

This is a place that Odin created to test the mettle of Archdiocese missionaries. Need an indicator of the Sigurd people's mentality? With all the wonderful systems to visit in Terran space, the Luches Utopia is the place most missionaries request to go. This is despite the known fact that the Luches government doesn't tolerate missionaries in its space. Anyone found preaching to the masses suffers extradition, imprisonment or death. Missionaries sneak in and lead a life of concealment, whispering the word to two or three at a time in the corner of some underground mine or back alley. It's these difficulties that draw the Sigurd missionaries. They want the chance to prove themselves in the eyes of Odin and High Priest Guttman.

While many missionaries disappear forever, some are successful. The covert nature of their missions puts them in league with the Luches Underground, the system's resistance movement (*SD:TNM* pp. 43). The Archdiocese religion fuels hope in the Underground and brings some peace to many who question whether they will live to see the next day.

The Luches government has a difficult time stopping the spread of the religion, which now reaches a critical juncture. As the religion crawls across the system, native Utopians are beginning to preach and spread the word. Stopping Sigurd missionaries from half-way across the galaxy is hard enough; trying to crack down on natives who pass anonymously through the streets is next to impossible.

On naval levels, the Sigurds and the Utopians see little of each other. Utopian pirate flights rarely go against Sigurd shipments, mostly because it's highly unprofitable to lose ships to berserker fanatics who would fight to the death over a shipment of diapers. The fact that the Utopian government allies itself with the Draconians makes it an enemy of the Sigurds, but their relative distance keeps conflict to a minimum.

Now for the first time, staring into the mountains of the Sigurd capitol, she felt something she'd never felt in her life. She couldn't explain the new feeling. Later that feeling grew, exploding out of her heart to envelop everything that she was. That change came two days after her arrival, when she and Corky attended a massive sermon.

Throughout the sermon, High Priest Guttman's words filled the air with power. He was impossible to resist; furious, devoted, invincible. When he spoke, all the tenets of the Sigurd Archdiocese crystallized in her mind, and she understood everything. At that moment, she knew she'd come home.



## Timeline

This is a fairly accurate timeline for the major events in the development and rise to power of the Sigurd Archdiocese.

**PreImp 612**—Blaine Sorenson founds first colony on Midgard.

**PreImp 580**—Jaleru Smith founds second colony for Church of Odin.

**PreImp 522**—Sigurd Archdiocese founded on Midgard.

**PreImp 480**—Sorenson colony founds planetation, Midgard Consulate.

**Imp 0:112**—Midgard Consulate registers as official house of the Empire.

**Imp 92**—Macedon Gaius makes historical visit to Midgard.

**Imp 119**—Consulate founds its first colony on Kamchatka.

**Imp 128**—Haas-Greebold asteroid cluster spotted. Rogue cluster is 17 times Midgard's mass. Scientists realize the cluster comes through every 912 years.

**Imp 129:094**—Haas-Greebold cluster is proven to be on collision course with Midgard.

**Imp 129:118**—Otto Lamphere deflection attempt fails, T-12 days.

**Imp 129:121**—Imperial Core of Engineers launches desperation plan. Gigaton disrupters blast planetoid-sized rocks. Feverish calculations to destroy most dangerous asteroids. Impact T-9 days.

**Imp 129:124**—Massive evacuations ensue.

**Imp 129:130**—Asteroid Holocaust begins on Midgard.

**Imp 129-134**—Five years of bombardment causes massive destruction. Midgard's economy disintegrates, industrial net smashed. No rescue vehicles dare enter system, population alone. Seventy-five percent of population killed.

**Imp 134:012**—Haas-Greebold belt passes through system. Due back again in AL 620.

**Imp 135**—Remnants of Consulate government overthrown in coup. Church of Odin takes over, claims Holocaust is punishment from Odin for Consulate's hedonist behavior. Archdiocese begins isolationist policies, refuses Imperial offers to rebuild. Midgard becomes backwater planet, fades from Imperial concern.

**Imp 137**—Ewanoma Cluster purchases Kamchatka colony.

**Imp 426**—Günther Guttman is born

**Imp 458**—Odin calls Guttman to the mountain top.

**Imp 459**—Guttman convicted of public slander against the Emperor, is banished from Earth.

**Imp 460**—Guttman arrives on Chimera in Imperial Sector 103 on the fringes of the Backnet.

**Imp 463**—Guttman's impact on Chimera continues to grow. The Imperial Department of Religions officially estimates 50,000 followers on Chimera. Interplanetary telecasts convert more on neighboring planets.

**Imp 464**—Blake Serevino, director of Sector 103, bans Guttman's telecasts. Official statements call the ban an attempt to maintain Imperial interests in the sector, but many speculate that the ban is actually Serevino's attempt to maintain his own power base.

**Imp 465**—Imperial Department of Religions reports are altered to show decreased activity by the Church of Odin, although Guttman's followers grow to an estimated 110,000. Planets neighboring Chimera stage protests to demand access to Guttman's guidance.



Guttman is imprisoned on charges of slander against the Empire; the charges are thought to have been fabricated by Serevino. Riots erupt on Chimera, Phynia and Alia 3 in response to the imprisonment; Over 100 people killed in seven days of fighting. Guttman's followers threaten revolution if he comes to harm.

The charges against Guttman are dropped due to lack of evidence, though his movements are officially restricted pending further investigation. No Imperial response to the rioting is forthcoming; it is suspected that Serevino bribed Imperial officials not to report the incidents.

**Imp 466**—The first of a number of assassination attempts against Guttman over the next two years. One of Guttman's followers interposes herself between Guttman and the assassin; both she and Guttman survive. The assassin, killed at the scene by Guttman's personal guard, is later identified in official reports as a Church of Odin member, likely from a rival sect.

Charles Brawn (later canonized as St. Brawn) is converted to the Church of Odin by Guttman.

Organized Church of Odin parishes form on Phynia, Alia 3 and Alia 6. Guttman is still officially banned from making any broadcasts or leaving Chimera, though his missionaries continue to spread his word.

**Imp 467**—IDR marks church members at one million in Sector 103 alone. Reports come in that Guttman's missionaries are spreading to other sectors.

**Imp 468**—Duke Serevino presents Guttman with a number of refitted passenger liners, in

a deal rumored to have been orchestrated in secret by Charles Brawn.

Guttman's followers spend the next year making the vessels spaceworthy.

Mega-rich followers donate even more ships. The Exodus Fleet begins to take shape.

**Imp 469:001**—On the first day of the new year, 27 passenger ships and factory vessels of various sizes depart from earth orbit and embark on pilgrimage to Midgard. Charles Brawn is among the thousands of believers following Guttman to this new land.

**Imp 469:124**—Günther Guttman arrives on Midgard.

**Imp 469:300**—Guttman pronounced Bishop. Puts his own money into converting several passenger ships into Warhounds.

**Imp 470:023**—Guttman introduces expansion plan to Sigurd High Council.

**Imp 470:168**—After months of furious debate, High Council votes down Guttman's expansion plan. Isolationist policies continue. Church of Odin separating into two defined camps: Traditionalists and followers of Guttman.

**Imp 470:231**—Fredericé Firacéné leads his pirates into Midgard's sector. Pirates victimize shipping lines.

**Imp 470:256**—Midgard navy, weak and inexperienced, is destroyed by Firacéné's pirate fleet. Calls for Imperial help go ignored.

**Imp 470:300**—Firacéné holds planet for ransom: demands massive tribute from Church of Odin or shipping lanes will be shut down completely. This would have been disastrous for Midgard, which imported 72 percent of its food.

# The Next Millennium

## Famous Moments in Sigurd Subtlety # 1: AL 7:302

Günther Guttman addressing the Galactic Press Corps at a 6 AL conference, shortly after the Draconian's arrival.

Fawn Abowitz (Terran Daily Beacon): "High Priest Guttman, how do you respond to the allegations that you're instigating friction with House Colos, House Devon, the ASP Technocracy and the Kashmere Commonwealth? Are these allegations true?"

Guttman: "These houses are filled with diseased vermin, tools of all things evil and cancerous. There will come a day when the leaders of these houses are stretched out on the burning rocks of Hel, evil dwarfs dripping poison into their



# Silent Death

eyes and cutting out their viperous tongues when they try to beg for forgiveness.”

(momentary silence)

Abowitz: “So the allegations are true?”

Guttman: “These houses are a paradise for sin and evil, the playgrounds of Loki himself. They will burn in a holocaust unlike anything man has ever known.”

Abowitz: “Can I take that as a ‘yes?’ ”



**Imp 471:002**—Guttman’s private army attacks Firacené. Well-trained, well-equipped and ready to die, Guttman’s small force demolishes the pirates. Firacené captured.

**Imp 471:012**—Without High Council’s approval, Guttman publicly executes Firacené. Guttman’s popularity on Midgard reaches new highs.

**Imp 471:042**—Guttman publicly declares the time has come for his leadership, his policies. He refuses to turn his navy over to the Sigurd government. Guttman says that the navy will fight for the “best interests” of the Church of Odin. Guttman holds all naval power on Midgard.

**Imp 471:091**—Guttman declared High Priest of Sigurd Archdiocese. Guttman sends praises to Empire, promises renewed cooperation from Midgard.

**Imp 471:112**—Charles Brawn cannonized.

**Imp 472-500**—Guttman revitalizes Midgard. Influx of immigrants helps convert planet from backwater status to a potential industrial power. New ports built and galactic trade encouraged through low tariffs. Mining industry booms, Midgard’s high mineral content sparks economic resurgence. Guttman concentrates on building Midgard’s infrastructure and military.

**Imp 476**—Brood first contact.

**Imp 500**—Terran-Hatchling war begins. Midgard ignored in first wave. Guttman declares open immigration policy for refugees, the planet’s population doubles.

**Imp 501**—Barat-Tuul falls to the Grubs.

**Imp 502**—Sunrunners arrive in Sigurd space and are welcomed by

Guttman. Michael Bach and his warriors rest on Midgard, but decline citizenship offer.

**Imp 510**—Swarm 701 attacks Midgard. Swarm destroyed by fighters from the carriers Thor and Loki.

**0 AL**—Swarm 1019 limps out of the demolished Imperial core and attacks House Shantac. Archdiocese forces enter Shantac space and obliterate the Swarm.

**1 AL**—Kamchatka re-claimed, becomes protectorate along with New Denmark and Agomio.

**2 AL**—Simbulia and Reiger 6 freely join the Archdiocese as protectorates. Terraforming begins on Jdalerbru. Niflheim colony founded.

**3:054 AL**—Yak-Tarull and Yak-Shindichi become Sigurd Archdiocese protectorates. Pirate fleet formed from House Vyrta’s military remains terrorizes sector.

**3:297 AL**—Vyrta Pirates destroyed by Viking Vanguard (Wing Y-12), clearing the sector of all major threats. Reiger 6 and Simbulia join Archdiocese as full members.

**4 AL**—Yak-Tarull and Yak-Shindichi given full member status. Terraforming begins on Panthalassa and Laurentia.

**5 AL**—House Colos brings the Draconian into Terran space. Jötunheim colony founded.

**6 AL**—Kamchatka, New Denmark, and Agomio become full members. House Devon returns to Terran space with the Primates close behind.

**8 AL**—Niflheim admitted as full member.

**9 AL**—Hvergglimir colony founded.

**11 AL**—Jdalerbru, still being terraformed by House Red Star, is admitted as a full member of the Archdiocese.

**12 AL**—The present

# New Weapons

The Sigurd Archdiocese is not a leader in the pursuit of new technologies. As High Priest Guttman says repeatedly, conquering worlds takes little more than fists and rocks. To the Sigurds, training, discipline, and dedication to the faith wins wars and battles—not billions spent on research and development.

The Sigurds, however, are not nihilists or primitives. They are a rather rich house willing pay top dollar for the highest levels of technology available. Their ships are first-rate, as are all their ground weapons and atmospheric defenses. The Sigurd weakness lies in poor levels of domestically produced technology. Sigurds either steal most technology through an extensive spy network or purchase it from the Kashmere Commonwealth. As the Archdiocese tries to phase out the Kashmere trade, it may soon face a severe technology gap with the rest of the Twelve.

Enrique Brawn, son of Charles Brawn and president of Brawn Laboratories, spearheads an internal movement pushing for proper research and development funding. Brawn has Guttman's ear; within the next decade the Archdiocese may have one of the leading R&D departments in Terran Space (due mainly to large resources and a strong economy). Until that time, however, any serious advances in technology may leave the Sigurds behind, and leave them vulnerable as they play catch-up.

## Gauss Technology

Charles Brawn is much more than a ship architect who merely combines parts into more efficient packages. He is also a creator of new technologies. As former Imperial designer, Brawn pioneered the use of gauss technology. When he established Brawn Laboratories on Midgard, he set his staff to completing that research.

The research centers on gauss fields, or magnetics. He found that rapidly alternating charges in a fixed field wreaked havoc on machines that contained any amount of ferrous metal. His weapon pioneered a new approach: instead of trying to hit a fast-moving vessel with a narrow beam weapon,

he affected the area around the ship. Since the target isn't the ship itself but a relatively large section of space, it is very easy to hit your target.

The Empire stored much of his research data in multiple locations across Empire. When the grubs first attacked, Imperial officials mothballed Brawn's research. Critics said it was useless against the organic Brood fighters. Brawn has since made it effective against those ships. When the Grubs wiped out the Imperial Core, they destroyed gauss weaponry research data. Only the DataSphere may still have access to the research, and they have not developed it.

With the Gauss weaponry lost to the rest of the galaxy, Brawn's creation became the sole property of the Sigurd Archdiocese. While still in an infant stage, the technology is powerful enough to arm many Sigurd ships. To date the Archdiocese is the only House with the Gauss Field weapons. Not even the Sunrunners know gauss secrets: any Sigurd ship flying for the Sunrunners will not have Gauss weapons on board.

## Using Gauss Field Generators (GFG) against multiple torps

Since the GFG uses a large field to increase its chances of hitting a target, it stands to reason it can hit multiple torps if those torps cluster together and come from the same direction.

The GFG can only strike multiple torps if a) the targeted torps are all in the same hex, b) the targeted torps are headed at the same target, and c) the target torps are within short range. A GFG can hit all torps that fall into the above categories. Make one attack roll for all torps. The damage is the number of torps destroyed, chosen by attacker, from torps that had their Defensive Value exceeded. This is not point defense: either the pilot or a gunner takes this action and it constitutes that person's firing action for the turn.

This rule will drastically change dog-fighting strategy. If someone wants to launch all of their torps simultaneously

# The Next Millennium

## Famous Moments in Sigurd Subtlety #2: AL 8:269

Sigurd Minister of Diplomacy Sven "Hot-Head" Kjar addressing the bi-partisan Sigurd/House Colos border committee.

Berry Mathilde (chief cartographer of the Q'raj Void Protectorate):  
"Minister Kjar, please understand that we are not "mindless puppets of House Colos," as you describe it. We're trying only to come to a mutually agreeable border so peace can come to this sector. We're only trying to prevent war and save lives."

Kjar: "Lizard-spawn and tools of the Beast are not people to be bargained with. There will be no peace with these blasphemous pawns of evil!"

Mathilde: "Minister, please! This is getting out of hand!"

Kjar: "Out of hand? You will see out of hand when the hordes of Hel pour forth from the Black Hole in their





# Silent Death

vessel Nagflar, swallowing all of humanity in their wake! House Colos brought this plague upon us, we should burn them at the stake, not bargain with them!"

Thomas Kitteren (House Colos ambassador to the Archdiocese): "You insult House Colos! Such comments are not taken lightly."

Kjar (standing on table, pulling knife): "You want insults? Your mother is a lecherous puss-filled boil on the face of Garmr, the Hound of Hel. Come, lizard-pawn, let us decide this border dispute between us, right here and right now!"

Security forces attempted to detain Kjar, who slew two guards before he was shot dead. The border commission demanded an official apology. Guttman instead praised Kjar's actions, assured the committee that he was now in Valhalla, and deemed Kjar the patron saint of Diplomacy.



against a Sigurd ship, those torps will usually travel together. When you look at the to-hit numbers of the GFG (2D8+6+ADB), it will almost automatically destroy any torp targeted. Enemy pilots who cluster their torps are probably going to lose them all. This rule makes pilots much more selective about launching torps, and is very effective in giving the Sigurd forces a unique fighting signature and style.

## Mjollnir Mk. 10 Gauss Field Generator

This weapon utilizes magnetic fields to spread its effect over large areas, thereby increasing the chances of hitting a target. The weapon focuses around a pulsating field that alternates positive and negative emanations, thereby creating a "shudder" effect on the targets. Instead of causing damage with a pin-point contact strike (as in beam weapons, mass-drivers or missiles), the shudder effect damages the target ship's structural integrity.

As can be expected of any weapon that spreads itself out over large areas, its damage is low. This is reflected with the 2D8+6+ADB to hit roll, while the damage is Low+1. Such damage makes the weapon nearly ineffective against ships with high damage reductions, but makes it particularly deadly against light fighters with low damage reduction.

Multiple Gauss Field Generators cannot be fitted into one mount. More than one mount can be placed on a ship.

- To Hit: 2D8+ADB+6
- Damage: Low+3  $\partial$
- Range: Short 1-3, Medium 4-7, Long 8-10
- Target Speed Restriction: none
- $\partial$  May hit all torps in one hex targeting one ship, if at short range.
- Cost: 4
- Slots: 4

## Gungnir Mk. 15 Gauss Field Generator

A direct-beam variant of the GFG, the Gungnir concentrates the "shudder" effect into a narrow band. One small area of the

target shudders violently while the remainder of the ship remains unaffected. The principles of inertia work against the target, tearing large holes in the hull.

Using a narrow band makes the Gungnir more effective against slow-moving targets. Faster ships are in and out of the weapon's field effect before any decent amount of shudder builds up, thereby escaping any damage.

- To Hit: 2D8+ADB+6
- Damage Medium+2  $\partial$
- Range: Short 1-5, Medium 6-10, Long 11-16
- Target Speed Restriction: Drive  $\leq$ 13
- $\partial$  May hit all torps in one hex targeting one ship, if at short range.
- Cost: 6
- Slots: 5

## Bifrost Cannon Mk. 60 Gauss Field Generator

Only the largest of Warhounds have room for this massive weapon. A breakthrough in gauss technology, the weapon places thousands of alternating, or "phasing," magnetic fields in a large but tight beam. The result is impressive as natural attract/repel principles tear the target apart. Revolving around a 50-ton gauss generator, this weapon registers a devastating impact on anything it contacts. This weapon's tight-beam principles require a firing arc of a single forward line of hexes, but unlike the Gungnir, the Bifrost Cannon has no speed restriction.

While considered "experimental," the Cannon's reliability and punch make it a key design element in many Sigurd Warhounds. The Longboat, in particular, uses it to devastating effect.

- To Hit: 2D10+ADB
- Damage: Allx2  $\partial$
- Range: Short 1-10, Medium 11-20, Long 21-30.
- Target Speed Restriction: none
- $\partial$  May hit all torps in one hex targeting one ship, if at short range.
- Cost: 32
- Slots: 32
- Crew: 5

# Famous Wings of the Sigurd Archdiocese

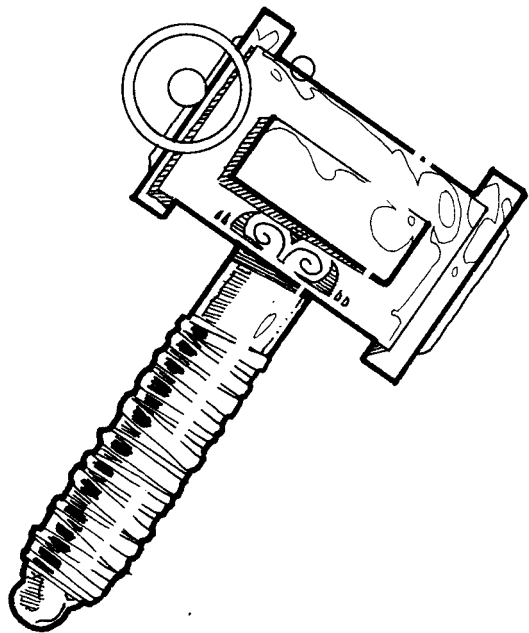

## T-01

“THOR’S HAMMER”

**Commanding Officer:** Bruno “The Legend” Maretti (16 confirmed kills)

Without a doubt, this is one of the most efficient fighter wings in the galaxy. Battle-tested, every pilot of this wing has at least three kills, while the average member is an ace, or “Magni,” having registered five kills.

The wing is permanently attached to the carrier Thor. The elite fighter unit of the Sigurd Archdiocese, every member of this squad has served time on a Sunrunner carrier. In a bizarre tradition born of the unusual relationship between the Sunrunners and the Sigurds, only a captain of a Sunrunner ship may nominate a pilot for membership into Thor’s Hammer. All pilots wear the hammer honoring Thomas “Thor” Bach, former leader of the Sunrunners. The Hammer honors time spent with the Sunrunners and warriors lost in battle during the one-year tour.

The position of squadron leader is a coveted title. Only Guttman himself can bestow the honor, usually given to heroes who are close to retirement, a final honor for years of service to the Archdiocese.

This squadron is the best of the best. If you fly against them, you’d better have your game face on. Not that it really matters; no one is going to see your face again.

### Squadron Summary

Typical pilot (Plt 8, Gnr 8, Lk 4)

Typical gunner (Gnr 8)

#### *BACH’S SYMPHONY*

##### Squadron Leader:

Marcus Endeavory (Plt 7, Gnr 10, Lk 10—  
nine confirmed kills)

**Assets:** 3 x Storm  
6 x Hammer  
2 x Hellbender

#### *ODIN’S ANVIL*

##### Squadron Leader:

Hjorolf Oddson (Plt 9, Gnr 6, Lk 5—  
six kills, twice awarded Modi status)

**Assets:** 8 x Hound  
4 x Hammer

#### *GUTTMAN’S WILL*

##### Squadron Leader:

Olaf Miller (Plt 10, Gnr 9, Lk 6—Modi  
status, double-Magni with ten kills)

**Assets:** 6 x Dagger  
3 x Storm  
1 x Iceberg

# The Next Millennium

## The Emperor’s Pet Genius

Outside of the Dukes and Earls of the Empire’s many houses, Charles Brawn ranked as one of the richest people in the galaxy. In fact, he was even richer than many of those same Dukes and Earls. Being the Emperor’s favorite fighter designer has a tendency to increase your bank accounts.

He worked his way up from the ranks of the countless legions of engineers that dot the design firms within the Empire. He distinguished himself early on in his career with a Crysteel alloy variant, lighter and thinner than its predecessors, and yet stronger than anything before it. In the last 20 years countless Imperial pilots came home alive solely because of Brawn’s inventions. He couldn’t walk in a bar



# Silent Death

anywhere near a military base and not be greeted with smiles and shouts by pilots and support crew; the people that dealt in death first-hand considered him a celebrity.

Money, fame and status graced his life, everything a man could want was his. And yet his life remained empty. Shallow. Devoid of meaning despite the joy he took from designing starcraft. It's funny how the fates can play in a person's life. Or at least Charles Brawn he thought it to be fate when he met Günther Guttman. Nowadays, tucked away in his fortress on Midgard, revered as a saint and guarded like a king, he knows it wasn't fate.

The guiding hand of Odin directs all things.

Charles Brawn loved to climb. Nothing as adventurous as tackling a huge mountain,



## L-01

“LOKI’S KIDS”

**Commanding Officer:** Nate “Norse Nose” Finnboqi

If Thor’s Hammer has a rival for status and lethal reputation, it is Fighter Wing L-01. Ever since the decisive victory over Swarm 701, “Loki’s Kids” have distinguished themselves with valor, bravery, and—above all, innovative tactics. Loki is the leader of all things evil in the Norse mythos, akin to Satan in the Christian pantheon. Much more than the God of Mischief, he symbolizes treachery and evil. His goal is the annihilation of the other gods. The irony of Loki is that rest of the warmongering Norse pantheon knows of his goal, but is unable to do anything about it.

This aspect of the mythos inspired the L-01 squadron to take the name Loki’s Kids. The pilots are problematic and dangerous, but just too damn good for the Sigurd command to discipline. Originally naval command created the wing as a last resort for pilots with discipline problems. In the early days of the Archdiocese, trained pilots were not something easily dismissed. Commanding officers threw the “bad seeds” together, expecting to use them in harrying missions and long patrols. No one expected them to gel and become one of the most famous fighter wings in Sigurd space.

L-01 fighter jockeys are the polar opposites of Thor’s Hammer pilots. While Hammer pilots are serious, solemn Missionaries who have traveled the galaxy spreading death and Odin’s word, Loki’s Kids are usually disciplinary problems far too talented to punish. Cocky, arrogant and wild, they are the hard-drinking, brawling, cavorting bad boys of the Sigurd navy.

Loki’s Kids quickly abandon a hopeless situation, counting on the fact that they will out-think their foes in the next encounter. Why die for nothing when you can re-group and win? Such beliefs and tactics fly in the face of Thor’s Hammer’s warrior souls. Loki’s Kids’ popularity doesn’t spread to the Sigurd military rank-and-file, most of whom view L-01 as lucky beyond belief.

## Squadron Summary

Typical pilot (Plt. 7, Gnr. 5, Lk 5)

Typical gunner (Gnr 7)

### *PROBLEM CHILD*

**Squadron Leader:** Leif Hedin  
(Plt. 8, Gnr 5, Lk 5—six confirmed kills, four reprimands)

**Assets:** 4 x Hound  
4 x Pharsii II  
1 x Iceberg

### *LI’L DEVILS*

**Squadron leader:** Joren Kirgarten  
(Plt. 9, Gnr. 9) (two kills, on permanent probation)

**Assets:** 4 x Night Hawk  
4 x Dagger  
4 x Pit Viper II

### *DELINQUENTS*

**Squadron Leader:** Yngvi Badjlkstaf  
(Plt. 6, Gnr. 10, Lk. 3, three confirmed kills, 10-year vet who’s spent three of those years in the brig)

**Assets:** 6 x Pit Viper II  
4 x Blizzard  
2 x Glaive III  
2 x Spirit Rider III  
1 x Iceberg



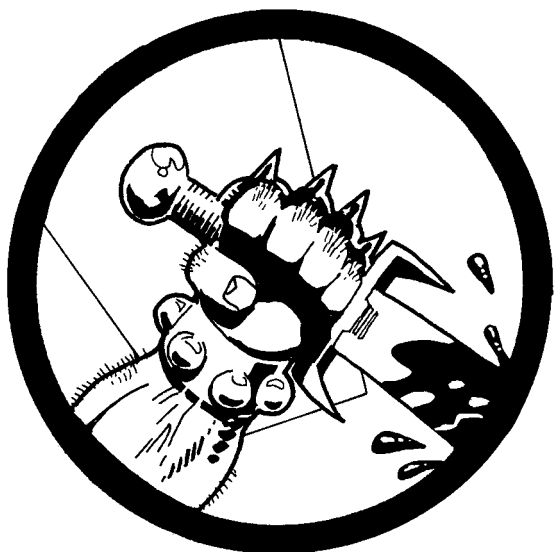

## MIDGARD 34TH DEFENSE

“TYR’S TYRANTS”

**Commanding Officer:** Glammad Saemund

The Fighting 34th is a model planetary fighter wing. Composed completely of atmospheric craft, the wing is capable of planetary dogfighting as well as combat in space.

Highly trained and incredibly disciplined, Tyr’s Tyrants often drill in multi-level combat, diving in and out of the external atmosphere to simulate a planetary attack. Sigurd command doesn’t rely on naval strength alone to protect Archdiocese planets; in the event the navy falls, every planet and protectorate can defend itself.

It has been over a decade since a direct attack was mounted on Midgard or anywhere else, so the pilots have little combat experience. Many Sunrunner-trained pilots cycle through the planetary defense wings to set an example and share the confidence that comes only from flying under fire.

### Squadron Summary

Typical pilot (Plt. 8, Gnr, 6, Lk 2)

Typical gunner (Gnr 6)

### SQUADRON 1

**Squadron Leader:** Knui Herbjon  
(Plt 10, Gnr 3, Lk 3—two kills)

**Assets:** 6 x Hound  
2 x Dagger  
1 x Glaive III

### SQUADRON 2

**Squadron Leader:** Mandy Jacobs  
(Plt 3, Gnr 3, Lk 4—no kills)

**Assets:** 6 x Hammer  
3 x Glaive III

### SQUADRON 3

**Squadron Leader:** Bill Mollerson  
(Plt 5, Gnr 8 Lk 2—no kills)

**Assets:** 6 x Dagger  
4 x Hammer



## MIDGARD 27TH SUPPORT WING

“STORM OF ODIN”

**Commanding Officer:** Pete Aussie

Every Archdiocese planet houses long-range support wings, designed for ground-launch re-stocking of depleted carrier and orbital launch platform squadrons. Storm of Odin is one such wing, crafted for the main purpose of flying out to re-enforce carrier wings and, if needed, fight close-atmosphere battles and near-planet defense.

Reflecting their design, these wings stock all types of atmospheric craft but try to focus on speed—the faster the

# The Next Millennium

but he developed proficiency free-scaling cliffs and sheer rock-faces. The Emperor ordered Charles to cease climbing, as it put the genius designer’s future at risk. Banished from all but the safest outings, Brawn lived his climbing dreams vicariously through the conquests of others.

He read all the climbing pages on the web, which exposed him to the story of Günther Guttman. The sole survivor of an ill-fated expedition in Finland, he’d come down from the mountain somehow converted to ancient Norse religions. The man lost three fingers to the experience, courtesy of frost-bite. Something in the story struck the ship designer; he decided he wanted to meet the man.



# Silent Death

Charles Brawn traveled freely throughout the Empire, constantly slipping by the many guards assigned to insure his protection. He traveled alone, and decided to pay Guttman a visit. Guttman immediately saw the opportunities such a man presented. Once in Guttman's presence, Brawn was putty. Energy and direction radiated from Guttman like a pulse laser—only three hours after the meeting began, Charles Brawn tearfully converted to the Church of Odin.

Shortly after that meeting, Imperial directors banished Guttman from Earth. The holy man fled for distant Chimera in Sector 103. Brawn remained on Earth, plotting, waiting for his chance to serve Odin.



reaction time to re-stock besieged carriers, the longer those carriers will live. The Sigurds don't have the resources of House Colos or Data Sphere, so they know that their minimal number of carriers must remain functional at all costs. Planetary Support wings train for just that purpose.

## Squadron Summary

Typical pilot (Plt 6, Gnr, 5, Lk 2)

Typical gunner (Gnr 6)

### *THE MIGHTY MEECES*

**Squadron Leader:** Sodjini "Mouse" Meece  
(Plt 5, Gnr 4, Lk 3—two kills)

**Assets:** 16 x Spirit Rider III  
2 x Glaive III

### *BLOODWING*

**Squadron Leader:** Herthjof "The Bleeder"  
Byati (Plt 8, Gnr 8, Lk 2—six kills)

**Assets:** 8 x Hound  
4 x Hammer  
2 x Glaive III

### *ACHNAD'S ACES*

**Squadron Leader:** Achnad Hafgrim  
(Plt 5, Gnr 2, Lk 2—no kills)

**Assets:** 4 x Blizzard  
4 x Hound  
4 x Hammer

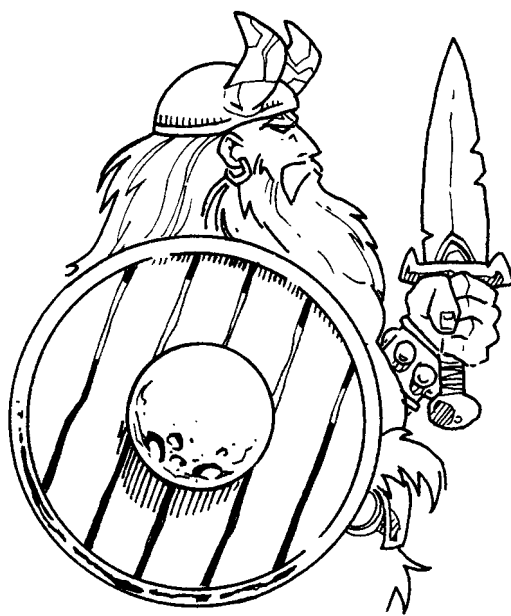

## Y-12 (SERVING ON THE CARRIER YGGR)

### "VIKING VANGUARD"

**Commanding Officer:** Katryn Hunthjof  
(11 confirmed kills)

The Vanguard is a typical Sigurd carrier wing. Skilled and well trained, they are efficient fighters more than willing to die for the cause. Like most fighter wings, the Vanguard comprises a mixture of heavy, medium and light fighters, although they possess a higher gunboat compliment than most wings.

Katryn Hunthjof is a former Valkyrie squad-leader. She took the Y-12 assignment as a stepping stone, hoping to someday to call the shots for the entire Valkyrie wing. She finds, however, much resistance in the regular army to the standard Valkyrie discipline level. While tough and dedicated many of the Sigurd pilots in the Vanguard, both men and women, chaff under the monastic life of the Valkyries. Hunthjof continues to cram strict codes down her pilots' throats with little success.

## Squadron Summary

Typical pilot (Plt. 5, Gnr, 5, Lk 5)

Typical gunner (Gnr 9)

### *SUICIDE RUNNERS*

**Squadron Leader:** Otrygg Neri  
(Plt. 7, Gnr 4, Lk 2—two kills)

**Assets:** 4 x Talon  
2 x Hammer  
2 x Drakar

### *HOUNDSLAYERS*

**Squadron Leader:** Brynhild "Lizard-Bane"  
Thvarison (Plt. 10, Gnr 3, Lk 1—one kill)

**Assets:** 6 x Dagger  
2 x Glaive III  
2 x Revenge  
1 x Iceberg

### *BIG DADDY'S ESCORT SERVICE*

**Squadron Leader:** Scott "Glumpy"  
Christian (Plt. 6, Gnr 6—one kill)

**Assets:** 6 x Spirit Rider  
3 x Storm II  
1 x Betafortress



## SIGURD ROTATING 101ST

“VALKYRIES”

**Commanding Officer:** Carajlaf Hjekling

When it comes to battle-proven warriors, the Valkyries are among the cream of the crop. While women can serve in Thor’s Hammer, any woman nominated for the honor usually applies to the Valkyries. It is a selective band, more selective than even the Hammer pilots, as no woman joins the Valkyries until she reaches Magni (ace) status. The Valkyrie wing does not allow men; they would be a distraction to the wing’s mental discipline.

Few people can live up to the Valkyries’ strict disciplinary standards. It is as much a religious cloister as a band of warriors—no drinking, no fraternizing and very little socializing is allowed in the two-year Valkyrie tour. They hold religious services twice a day. Valkyries are the most devout, self-sacrificing warriors in the Archdiocese. Many graduate to leadership positions in the navy, while many more go on to careers in the church proper.

### Squadron Summary

Typical pilot (Plt 9, Gnr, 7, Lk 7)

Typical gunner (Gnr 9)

### VALHALLA BOUND

**Squadron Leader:** Denise Shaft  
(Plt 10, Gnr 10, Lk 8—12 kills)

**Assets:** 4 x Hound  
4 x Dagger  
2 x Storm

### LADIES IN WAITING

**Squadron Leader:** Mathilde Descambabrio  
(Plt 7, Gnr 9, Lk 5—six kills)

**Assets:** 6 x Hammer  
4 x Pharsii II

### DEATH MAIDENS

**Squadron Leader:** Sandy “Ms. Death”  
Dugan (Plt 10, Gnr 9, Lk 5—17 kills)

**Assets:** 4 x Dagger  
4 x Hound  
2 x Iceberg



## SIGURD ROTATING 201ST

“MISSIONARIES OF DEATH”

**Commanding Officer:** Hjotra Edberg

Another of the elite Sigurd forces, the Missionaries of Death enlist the most fanatical pilots in all the Archdiocese. These are people who dedicate their lives to reaching Valhalla, either by dying in battle or by killing so many Sigurd enemies that Odin will someday welcome them with open arms. The Missionaries take the most dangerous missions. Often times these sorties border on suicidal.

Once accepted into the 201st, you are there until your 35th birthday. Most pilots don’t live that long. The Missionaries of Death are so absolutely fanatical they remove all escape pods from their fighters.

# The Next Millennium

## Exodus

Charles Brawn straightened the button placket of his coat as he stood outside the duke’s audience chamber, waiting for Duke Serevino to finish the meeting with the Kashmere diplomat. Although not military himself, Brawn had chosen a coat for this meeting with a decidedly military cut—with the Terran Star Empire emblem displayed, though not too prominently.

Brawn knew he walked a fine line this day. He had been instructed in every detail of this plan. To deviate from any part might just cost him his life.

High Priest Guttman had been very clear: Duke Blake Serevino was not a man to be taken lightly, no matter what foolish, foppish facade he portrayed to the masses. The Em-



# Silent Death

peror may have been fooled into thinking Serevino nothing more than a petty hereditary noble, but Guttman knew Serevino to be a calculating and quite ruthless opponent. The several assassination attempts on Guttman over the past two years, though unsuccessful, proved Serevino's commitment to eliminating his foe.

*That Guttman has chosen me to be the bearer of this news, thought Brawn, Chosen me to be the warrior who wields this weapon of information—it must mean that he believes in me. I swear to Odin All-Father that I will not fail him.*

The doors opened, and from the corner of his eye Brawn watched the Kashmere diplomat and his aides leave the duke's audience hall. He heard the chamberlain's voice ring through the hall,



Missionaries often fly dangerous sorties, guaranteed to result in heavy losses. In larger-scale encounters they often fly point duty, diving headlong into the opposition and doing as much damage as possible before supporting ships fly in to exploit strategic advantages. A Missionary of Death lives for battle and rarely fears death. A Missionary that actually survives to see a 35th birthday usually has double-digit kill numbers and is considered a hero amongst heroes.

As one can guess, the per-mission casualty rate amongst the 201st is extremely high. On two occasions the entire wing was wiped out. However, the Church of Odin breeds fanaticism, and there is never a shortage of volunteers. None of the squadrons have catchy names, by the way; they're rarely around long enough to earn one.

## Squadron Summary

Typical pilot (Plt 7, Gnr 8, Lk 10)

Typical gunner (Gnr 6)

### SQUAD 1

**Squadron Leader:** Gloria "Glory Road" Banks (Plt 8, Gnr 8, Lk 8—three kills)

**Assets:** 3 x Storm II  
3 x Pit Viper II  
2 x Hound  
1 x Hammer  
1 x Storm  
1 x Hell Bender

### SQUAD 2

**Squadron Leader:** Svanhit "Hull-Splitter" Aesa (Plt 5, Gnr 3, Lk 2—one kill)

**Assets:** 4 x Storm  
3 x Pit Viper II  
2 x Spirit Rider III  
1 x Epping  
1 x Hammer  
1 x Star Raven

### SQUAD 3

**Squadron Leader:** Rolf Ivarson (Plt 4, Gnr 10, Lk 3—four kills)

**Assets:** 1 x Sorenson III  
4 x Spirit Rider III  
3 x Pit Viper II  
2 x Hammer  
2 x Storm  
2 x Glaive III

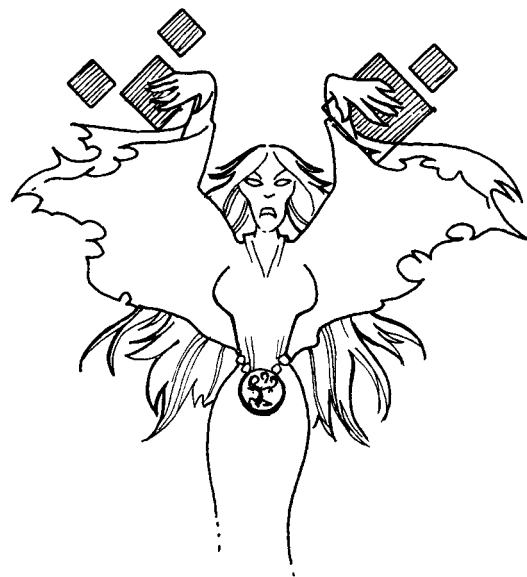

## MIDGARD 99TH SUPPORT WINGS

"FRIGID WITCHES"

**Commanding Officer:** Cassandra Piertson

What the Valkyries are to Thor's Hammer, the Frigid Witches are to Loki's Kids. Undisciplined and rowdy, many are pilots who couldn't make the cut or dropped out of the Valkyrie wing due to the strict standards. Men can serve in the 99th—the few spots open to men have a waiting list over 300 pilots deep.

The Witches claim they can out-drink, out-brawl and out-fly any pilot in the Sigurd Navy. Wild and practically uncontrollable, captains dread their support-role training flights to the carrier decks—discipline is sure to drop and fraternizing is sure to rise despite threats or punishments. As yet the naval command has managed to keep the 99th from training with the Ymir, home of Loki's Kids. Most fear the ship would be practically useless by the time the two squadrons finished cavorting and fighting.

## Squadron Summary

Typical pilot (Plt 8, Gnr 6, Lk 2)

Typical gunner (Gnr 8)

### ***THE VESTAL VIRGINS***

**Squadron Leader:** Magda Freussen  
(Plt 6, Gnr 9, Lk 4—eight kills)

**Assets:** 4 x Night Hawk  
4 x Hammer  
1 x Iceberg

### ***THE PARTY GIRLS***

**Squadron Leader:** Belle Hodbroddson  
(Plt 7, Gnr 4, Lk 2—three kills)

**Assets:** 6 x Hound  
4 x Dagger  
1 x Iceberg

### ***DOMINATRIXIES***

**Squadron Leader:** Carlitta Hedin  
(Plt 8, Gnr 5, Lk 1—one kill)

**Assets:** 4 x Hound  
2 x Storm II  
2 x Night Hawk  
2 x Glaive III



### **SIGURD ROTATING 133RD**

**“SERPENT DEATH”**

**Commanding Officer:** Reig “Bingo”  
Billings

Sigurd strategy utilizes a three-tiered approach: fixed planetary defense, carrier wings, and orbital launch platforms. The platforms bridge the gap between fixed

defense and carriers. Drastically cheaper and easier to maintain than a full-fledged carrier, the platforms move from planet to planet based on need.

Orbital launch platforms are very similar to a stripped-down carrier. Only launch-bay functions and launch-crew quarters are needed. Specialty translight tow vehicles move the platforms from planet to planet, depositing them where strategy dictates. Three orbital platforms are currently in service; the Skoll, the Utgardr, and the Djevs.

The pilots of these wings bunk planet-side to save costs and cut down on platform personnel support requirements. With this policy they have no true home, hence the term “rotating.”

The 133rd is a typical platform wing. Its purpose is simple—to obliterate anything that comes near a planet before the enemy can launch surface bombardment weapons. Some of the heaviest Sigurd fighters stock the platform wings.

### **Squadron Summary**

Typical pilot (Plt 6, Gnr, 4, Lk 2)

Typical gunner (Gnr 5)

### ***VAGABONDS***

**Squadron Leader:** Barry “The Cretin” Adz  
(Plt 8, Gnr 9, Lk 4—three kills)

**Assets:** 6 x Hammer  
4 x Storm II

### ***HOBO HAMMER***

**Squadron Leader:** Finn Johnson  
(Plt 4, Gnr 6, Lk 3—two kills)

**Assets:** 6 x Hound  
3 x Sentry  
1 x Iceberg

### ***CAPTAIN CRUNCH***

**Squadron Leader:** Finbogi “Crunch”  
Grettir (Plt 10, Gnr 2, Lk 4—four kills)

**Assets:** 4 x Hammer  
4 x Storm II  
1 x Iceberg

# The Next Millennium

announcing him: “Milord, Sir Charles Brawn, of Terran House Imperial.”

Brawn stepped into the doorway, surveyed the room. The duke’s audience chamber was much smaller than the Emperor’s, though it was nearly as opulent. Flowing drapes of magenta and violet waved in the created breeze, and huge bronze statues of olympian men and women struck poses while supporting the domed roof. On the small dias opposite the doors stood a single gilt-edged chair. *Not a throne?* Brawn thought. *At least he has some sense of subtlety.*

Serevino stood as Brawn entered the chamber, and walked down the dias steps to meet Brawn half way. Brawn studied his opponent as he approached. The duke’s dress and grooming were perfection: violet





# Silent Death

coat impeccably tailored, the flair of a white shirt visible at throat and wrists. His hair, a striking black compared to Brawn's own average brown, was neatly trimmed. But this duke was different—stronger somehow—than the affected fop Brawn had seen in transmissions and at Imperial state occasions. Taller than Brawn by half a head, the duke descended on him with smooth grace. *A striking man, thought Brawn, with no small amount of personal charisma. He has not the holy fire of Guttman, perhaps, but this is a man that other men would follow.*

The duke clasped Brawn's hand, a firm grip. "Charles Brawn," he said, "What a pleasant surprise. I certainly would not have expected one of the Emperor's favorites to grace our tiny sector with his presence. This is wonderful.



## NEW DENMARK 14TH DEFENSE WING

### "BEASTSLAYER"

**Commanding Officer:** Ottar Halferson

Not everyone in the Sigurd Archdiocese follows the faith. All immigrants are welcome with open arms by the growing government, which realizes the need for fresh blood and new workers. Although many ignore the faith, mandatory military service remains a requirement for all.

Many planetary defense wings are staffed liberally with talented pilots who don't follow the faith. These pilot's rights merit respect, but of course they are surrounded with the positive influences of the Archdiocese religion. Lack of faith does not preclude them from hating the Prometheans—Sigurd propaganda poisons Archdiocese youth against the Lizards and the Beastmen.

The Beastslayers have a rather large percentage of non-believer pilots. Almost 35 percent of the pilots in this wing don't follow the faith. While reports of religious discrimination are few, the 14th doesn't have the cohesion found in other wings. So far the wing hasn't "gelled" like many other Sigurd units. Many analysts blame this on the large percentage of non-faithful pilots.

## Squadron Summary

Typical pilot (Plt 6, Gnr 4, Lk 3)

Typical gunner (Gnr 6)

### *THE GUNTHER GUTTMAN FAN CLUB*

**Squadron Leader:** K'Take Hidorri  
(Plt 10, Gnr 10, Lk 10—12 kills)

**Assets:** 4 x Hammer  
6 x Hound

### *PAIN JUNKIES*

**Squadron Leader:** Nate McGuiness  
(Plt 5, Gnr 5, Lk 3—one kill)

**Assets:** 6 x Dagger  
2 x Storm

### *ODIN'S ENFORCERS*

**Squadron Leader:** Lisa Essech  
(Plt 7, Gnr 3—no kills)

**Assets:** 2 x Night Hawk  
4 x Hound  
4 x Spirit Rider III  
2 x Hammer

**HOUND**  
I.D. ■  
BPV: 19

TPV

**Pilot**  
Impulsegun (F)  
To Hit: 2D8+ADB  
Damage: High  
Range: 3/8/10

**Crew**  
**PILOT**  
Plt: \_\_\_\_\_  
Gnr: \_\_\_\_\_  
Luck: \_\_\_\_\_

Mk. 20  
Torps

Decoys: ○  
P-D: 1-3 (1)  
Dmg Con: 1-4  
Tons: 203

Tight Turn Cost: \_\_\_\_\_+3

DAMAGE TRACK

|   |    |   |    |    |   |    |   |
|---|----|---|----|----|---|----|---|
| → |    |   | t  | 17 | 2 | 15 | 1 |
|   | 13 | * | 11 | 8  | w | 5  | × |

**HOUND**  
I.D. ■  
BPV: 19

TPV

**Pilot**  
Impulsegun (F)  
To Hit: 2D8+ADB  
Damage: High  
Range: 3/8/10

**Crew**  
**PILOT**  
Plt: \_\_\_\_\_  
Gnr: \_\_\_\_\_  
Luck: \_\_\_\_\_

Mk. 20  
Torps

Decoys: ○  
P-D: 1-3 (1)  
Dmg Con: 1-4  
Tons: 203

Tight Turn Cost: \_\_\_\_\_+3

DAMAGE TRACK

|   |    |   |    |    |   |    |   |
|---|----|---|----|----|---|----|---|
| → |    |   | t  | 17 | 2 | 15 | 1 |
|   | 13 | * | 11 | 8  | w | 5  | × |

**HOUND**  
I.D. ■  
BPV: 19

TPV

**Pilot**  
Impulsegun (F)  
To Hit: 2D8+ADB  
Damage: High  
Range: 3/8/10

**Crew**  
**PILOT**  
Plt: \_\_\_\_\_  
Gnr: \_\_\_\_\_  
Luck: \_\_\_\_\_

Mk. 20  
Torps

Decoys: ○  
P-D: 1-3 (1)  
Dmg Con: 1-4  
Tons: 203

Tight Turn Cost: \_\_\_\_\_+3

DAMAGE TRACK

|   |    |   |    |    |   |    |   |
|---|----|---|----|----|---|----|---|
| → |    |   | t  | 17 | 2 | 15 | 1 |
|   | 13 | * | 11 | 8  | w | 5  | × |

**HOUND**  
I.D. ■  
BPV: 19

TPV

**Pilot**  
Impulsegun (F)  
To Hit: 2D8+ADB  
Damage: High  
Range: 3/8/10

**Crew**  
**PILOT**  
Plt: \_\_\_\_\_  
Gnr: \_\_\_\_\_  
Luck: \_\_\_\_\_

Mk. 20  
Torps

Decoys: ○  
P-D: 1-3 (1)  
Dmg Con: 1-4  
Tons: 203

Tight Turn Cost: \_\_\_\_\_+3

DAMAGE TRACK

|   |    |   |    |    |   |    |   |
|---|----|---|----|----|---|----|---|
| → |    |   | t  | 17 | 2 | 15 | 1 |
|   | 13 | * | 11 | 8  | w | 5  | × |

- CRITICAL HITS**

  - 2 — **Pilot killed.** Hound may perform no further actions. Defensive Value drops to 5.
  - 3 — **Torp load jettisons.** Remove all remaining torps.
  - 4 — **Impulsegun jam.** Impulsegun may not fire next turn.
  - 5 — **Maneuvering Thrusters damaged.** Reduce Defensive Value by 3.
  - 6 — **Ping!** Shot bounces off Crystantium armor.
  - 7 — **Engines hit.** Reduce Drive by half, ignoring fractions.
  - 8 — **Engine sputters.** Reduce Drive by 3 until after next turn.
  - 9 — **ECM destroyed.** Hound may no longer jam torps.
  - 10 — **Good hit!** Take an extra D4 damage.
  - 11 — **Pilot stunned.** Hound may not move or fire until after the next game turn.
  - 12 — **Welcome to Valhalla.** Hound disintegrates.
- IMPULSEGUN SPECS**

Short Range: 1-3 hexes (+1 To Hit).  
 Medium Range: 4-8 hexes.  
 Long Range: 9-10 hexes (-1 To Hit).

**TPV**

**Pilot**  
**Missile Launcher (F)**  
 Lock-on < \_\_\_\_\_  
 ○ ○ ○ ○ ○  
 ○ ○ ○ ○ ○  
 ○ ○ ○ ○ ○  
 ○ ○ ○ ○ ○

**Crew**  
**PILOT**  
 Plt: \_\_\_\_\_  
 Gnr: \_\_\_\_\_  
 Luck: \_\_\_\_\_

**Pilot**  
**1 Meld Laser (F)**  
 To Hit: 2D8+ADB  
 Damage: Medium  
 Range: 6/18/20  
 Target SR ≤12

**Pilot**  
**1 Mjölmir (F)**  
 To Hit: 2D8+ADB+6  
 Damage: Low+3 ∂  
 Range: 3/7/10

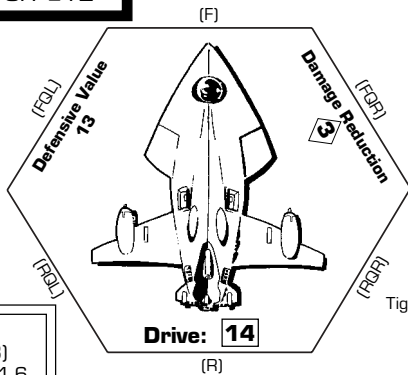

Tight Turn Cost: \_\_\_\_\_+3

Decoys: ○  
 P-D: 1-4 (3)  
 Dmg Con: 1-6  
 Tons: 394

### DAMAGE TRACK

|   |  |    |   |   |    |    |   |   |  |    |   |   |  |
|---|--|----|---|---|----|----|---|---|--|----|---|---|--|
| → |  |    |   |   | 14 |    |   |   |  | 13 | 3 | W |  |
|   |  | 12 |   | * |    | 11 | 2 | W |  | 9  |   |   |  |
|   |  | 7  | 1 | * |    | 5  | w | 3 |  | 2  | × |   |  |

**TPV**

**Pilot**  
**Missile Launcher (F)**  
 Lock-on < \_\_\_\_\_  
 ○ ○ ○ ○ ○  
 ○ ○ ○ ○ ○  
 ○ ○ ○ ○ ○  
 ○ ○ ○ ○ ○

**Crew**  
**PILOT**  
 Plt: \_\_\_\_\_  
 Gnr: \_\_\_\_\_  
 Luck: \_\_\_\_\_

**Pilot**  
**1 Meld Laser (F)**  
 To Hit: 2D8+ADB  
 Damage: Medium  
 Range: 6/18/20  
 Target SR ≤12

**Pilot**  
**1 Mjölmir (F)**  
 To Hit: 2D8+ADB+6  
 Damage: Low+3 ∂  
 Range: 3/7/10

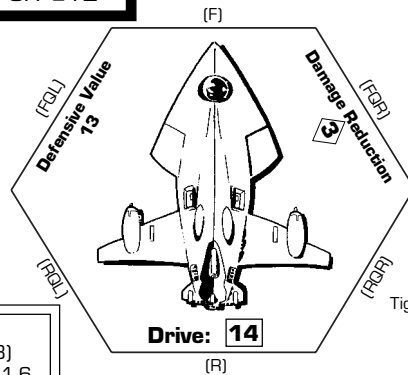

Tight Turn Cost: \_\_\_\_\_+3

Decoys: ○  
 P-D: 1-4 (3)  
 Dmg Con: 1-6  
 Tons: 394

### DAMAGE TRACK

|   |  |    |   |   |    |    |   |   |  |    |   |   |  |
|---|--|----|---|---|----|----|---|---|--|----|---|---|--|
| → |  |    |   |   | 14 |    |   |   |  | 13 | 3 | W |  |
|   |  | 12 |   | * |    | 11 | 2 | W |  | 9  |   |   |  |
|   |  | 7  | 1 | * |    | 5  | w | 3 |  | 2  | × |   |  |

### CRITICAL HITS

- 2 — **Praise St. Brawn!** Armored cockpit saves Pilot. No damage.
- 3 — **Missile Launcher misfire.** Lose 1D6 missiles.
- 4 — **Cockpit fire.** Defensive Value reduced by 6 for next game turn only as Pilot deals with fire.
- 5 — **Magnetic fluctuation.** Mjölmir may not fire next turn.
- 6 — **Love that Crysteel.** Shot reflects harmlessly off armor.
- 7 — **Hull buckles.** Defensive Value reduced by 3.
- 8 — **Engine sputters.** Reduce Drive by 3 for next turn only.
- 9 — **Maneuvering thrusters damaged.** Reduce Defensive Value by 3 for next turn only.
- 10 — **Electronic Warfare knock-down.** Dagger may no longer jam torps.
- 11 — **Pilot stunned.** Dagger may not move or fire until after the next game turn.
- 12 — **Visit from Odin.** The All-Father comes to claim Pilot as Dagger falls to pieces.

### MJOLNIR SPECS ∂

**Short Range:** 1-3 hexes (+1 To Hit).  
**Medium Range:** 4-7 hexes.  
**Long Range:** 8-10 hexes (-1 To Hit).  
 ∂ May hit all torps in one hex targeting one ship, if at short range.

### MELD LASER SPECS

**Short Range:** 1-6 hexes (+1 To Hit).  
**Medium Range:** 7-18 hexes.  
**Long Range:** 19-20 hexes (-1 To Hit).  
**Target Speed Restriction:** Target's Drive value must be ≤12.

### GAME TURN RECORD TRACK

|   |   |   |   |   |   |   |   |   |    |    |    |    |    |    |    |    |    |    |    |
|---|---|---|---|---|---|---|---|---|----|----|----|----|----|----|----|----|----|----|----|
| 1 | 2 | 3 | 4 | 5 | 6 | 7 | 8 | 9 | 10 | 11 | 12 | 13 | 14 | 15 | 16 | 17 | 18 | 19 | 20 |
|---|---|---|---|---|---|---|---|---|----|----|----|----|----|----|----|----|----|----|----|

# HAMMER

I.D.

BPV: 60

TPV

**Pilot**  
**Ion Ram (F)**  
 To Hit: 2D8+ADB  
 Damage: All  
 Range: 5/13/15  
 Target SR ≤15

**Crew**  
**PILOT**  
 Plt: \_\_\_\_\_  
 Gnr: \_\_\_\_\_  
 Luck: \_\_\_\_\_  
**GUNNER**  
 Gnr: \_\_\_\_\_

Mk. 20  
 Torps

○  
○  
○  
○

Mk. 10  
 Torps

○  
○  
○  
○  
○

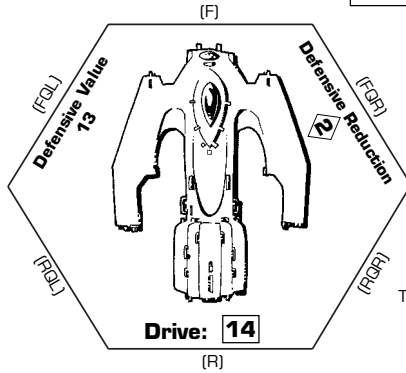

Tight Turn Cost: \_\_\_\_\_+3

Decoys: ○ ○ ○ ○  
 P-D: 1-4 (2)  
 Dmg Con: 1-4  
 Tons: 415

**Gunner**  
**1 Mjólnir (360°)**  
 To Hit: 2D8+ADB+6  
 Damage: Low+3 ∂  
 Range: 3/7/10

DAMAGE TRACK

|    |   |   |   |   |    |   |    |   |   |   |   |    |  |
|----|---|---|---|---|----|---|----|---|---|---|---|----|--|
|    |   |   | t |   |    | T | 14 |   |   | t | 2 | 13 |  |
| 12 | * |   | T |   | 11 |   | w  | t | 9 | 1 |   | T  |  |
| 7  | t | T | w | * | 5  | t | t  | 3 | 2 |   |   | X  |  |

# HAMMER

I.D.

BPV: 60

TPV

**Pilot**  
**Ion Ram (F)**  
 To Hit: 2D8+ADB  
 Damage: All  
 Range: 5/13/15  
 Target SR ≤15

**Crew**  
**PILOT**  
 Plt: \_\_\_\_\_  
 Gnr: \_\_\_\_\_  
 Luck: \_\_\_\_\_  
**GUNNER**  
 Gnr: \_\_\_\_\_

Mk. 20  
 Torps

○  
○  
○  
○

Mk. 10  
 Torps

○  
○  
○  
○  
○

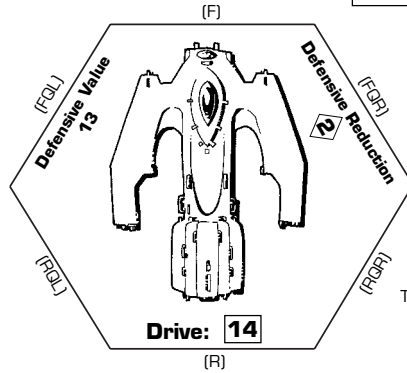

Tight Turn Cost: \_\_\_\_\_+3

Decoys: ○ ○ ○ ○  
 P-D: 1-4 (2)  
 Dmg Con: 1-4  
 Tons: 415

**Gunner**  
**1 Mjólnir (360°)**  
 To Hit: 2D8+ADB+6  
 Damage: Low+3 ∂  
 Range: 3/7/10

DAMAGE TRACK

|    |   |   |   |   |    |   |    |   |   |   |   |    |  |
|----|---|---|---|---|----|---|----|---|---|---|---|----|--|
|    |   |   | t |   |    | T | 14 |   |   | t | 2 | 13 |  |
| 12 | * |   | T |   | 11 |   | w  | t | 9 | 1 |   | T  |  |
| 7  | t | T | w | * | 5  | t | t  | 3 | 2 |   |   | X  |  |

## CRITICAL HITS

- 2 — Pilot killed. Hammer may not move, nor may Pilot's weapons fire. Defensive value drops to 5.
- 3 — Mk. 10 detonation. Hammer takes 1D12 if any Mk. 10 torps are still in rack.
- 4 — Gauss Generator hit. Reduce Mjólnir's chance To Hit by 5.
- 5 — Magnetic fluctuation. Mjólnir may not fire next turn.
- 6 — Love that Crysteel. Shot reflects harmlessly off armor.
- 7 — Torp rack hit. Lose 1D4 random torps of attacker's choice.
- 8 — Armor belts sheared off. Hammer's Damage Reduction reduced to 0. -1 to DV.
- 9 — Ionizer short. Ion Ram may not fire next turn.
- 10 — Gunner killed. Mjólnir may not fire.
- 11 — Pilot dazed. Reduce Defensive Value by 2 next turn. Pilot may not fire until after next game turn.
- 12 — Explosive chain reaction. Crew dies instantly as Hammer shatters.

## MJOLNIR SPECS ∂

Short Range: 1-3 hexes (+1 To Hit).  
 Medium Range: 4-7 hexes.  
 Long Range: 8-10 hexes (-1 To Hit).  
 ∂ May hit all torps in one hex targeting one ship, if at short range.

## ION RAM SPECS

Short Range: 1-5 hexes (+1 To Hit).  
 Medium Range: 6-13 hexes.  
 Long Range: 14-15 hexes (-1 To Hit).  
 Target Speed Restriction: Target's Drive value must be ≤15.

## GAME TURN RECORD TRACK

|   |   |   |   |   |   |   |   |   |    |    |    |    |    |    |    |    |    |    |    |
|---|---|---|---|---|---|---|---|---|----|----|----|----|----|----|----|----|----|----|----|
| 1 | 2 | 3 | 4 | 5 | 6 | 7 | 8 | 9 | 10 | 11 | 12 | 13 | 14 | 15 | 16 | 17 | 18 | 19 | 20 |
|---|---|---|---|---|---|---|---|---|----|----|----|----|----|----|----|----|----|----|----|

TPV

Pilot 1 Gungnir (F) To Hit: 2D8+ADB+6 Damage: Medium+2 Range: 5/10/16 Target SR ≤13

Pilot Missile Launcher (F) Lock-on < 10

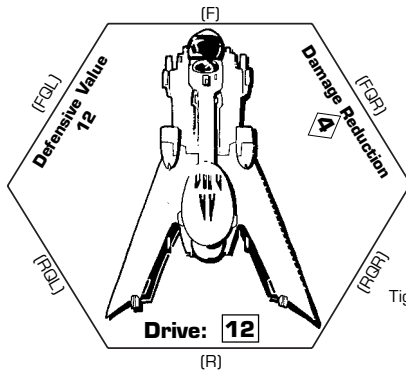

Tight Turn Cost: +3

Decoys: 6 P-D: 1-6 (3) Dmg Con: 1-3 Tons: 995

Gunner A 1 Impulsegun (360°) To Hit: 2D8+ADB Damage: High Range: 3/8/10

Gunner B Missile Launcher (RQL) (R) (RQR) Lock-on < 10

Gunner B 2 Blatguns (R) To Hit: 2D6+ADB+1 Damage: High Range: 2/6/10 Target SR ≤13

DAMAGE TRACK

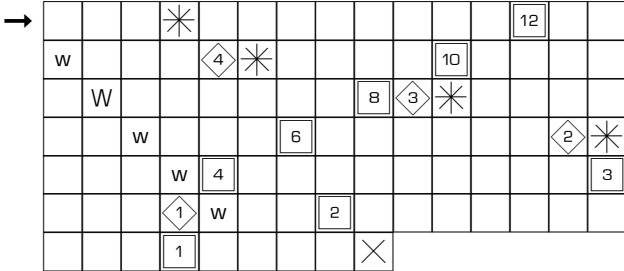

TPV

Pilot 1 Gungnir (F) To Hit: 2D8+ADB+6 Damage: Medium+2 Range: 5/10/16 Target SR ≤13

Pilot Missile Launcher (F) Lock-on < 10

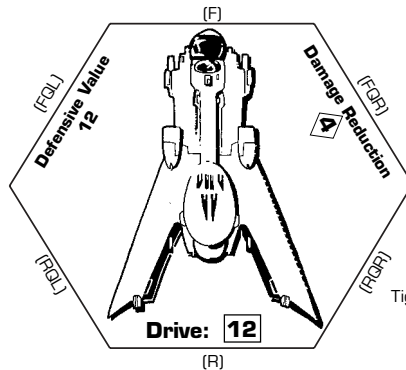

Tight Turn Cost: +3

Decoys: 6 P-D: 1-6 (3) Dmg Con: 1-3 Tons: 995

Gunner A 1 Impulsegun (360°) To Hit: 2D8+ADB Damage: High Range: 3/8/10

Gunner B Missile Launcher (RQL) (R) (RQR) Lock-on < 10

Gunner B 2 Blatguns (R) To Hit: 2D6+ADB+1 Damage: High Range: 2/6/10 Target SR ≤13

DAMAGE TRACK

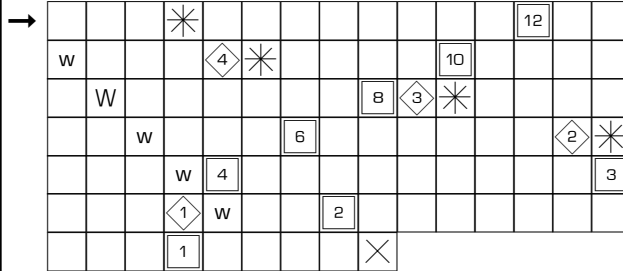

CRITICAL HITS

- 2 - Pilot killed. Storm may not move, nor may Pilot's weapons fire. Defensive value drops to 5.
3 - Missile Launcher Destroyed
4 - Compartment depressurization. Gunner A killed instantly.
5 - Magnetic fluctuation. Gungnir may not fire next turn.
6 - Crystantium crack. Reduce Damage Reduction to 0.
7 - Impulsegun rotator hit. Impulsegun loses 360° arc. Roll 1D6 to randomly determine what arc weapon is stuck in for remainder of encounter.
8 - Engine hit. Reduce Drive by 3.
9 - Gungnir Targeter damaged. Modify To Hit by -5.
10 - Wiring short. Gunner B is electrocuted.
11 - Blat jam. Blatguns may not fire until after next game turn.
12 - Hull fractured. Storm cracks up into useless space junk.

BLATGUN SPECS

Short Range: 1-4 hexes (+1 To Hit).
Medium Range: 5-10 hexes.
Long Range: 11-15 hexes (-1 To Hit).
Target Speed Restriction: Target's Drive value must be ≤13.

GUNGNIR SPECS

Short Range: 1-5 hexes (+1 To Hit).
Medium Range: 6-10 hexes.
Long Range: 11-16 hexes (-1 To Hit).
Target Speed Restriction: Target's Drive value must be ≤13.

May hit all torps in one hex targeting one ship, if at short range.

IMPULSEGUN SPECS

Short Range: 1-3 hexes (+1 To Hit).
Medium Range: 4-8 hexes.
Long Range: 9-10 hexes (-1 To Hit).

**TPV**

**Pilot**  
**1 Gungnir (F)**  
 To Hit: 2D8+ADB+6  
 Damage: Medium+2 Ⓜ  
 Range: 5/10/16  
 Target SR ≤13

**Crew**  
**PILOT**  
 PIt: \_\_\_\_\_  
 Gnr: \_\_\_\_\_  
 Luck: \_\_\_\_\_  
**GUNNER A**  
 Gnr: \_\_\_\_\_  
**GUNNER B**  
 Gnr: \_\_\_\_\_

**Pilot**  
**Missile Launcher (F)**  
 Lock-on < \_\_\_\_\_  
 ○○○○○○ ○○○○○○  
 ○○○○○○ ○○○○○○

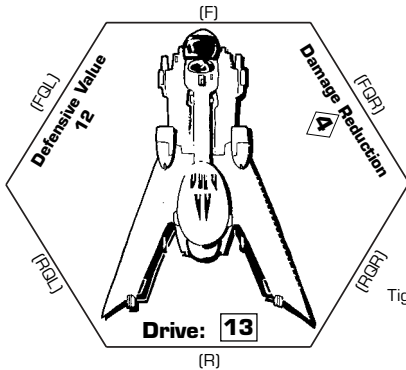

Tight Turn Cost: \_\_\_\_\_+3

Decoys: ○○○○  
 P-D: 1-8 (3)  
 Dmg Con: 1-4  
 Tons: 995

**Gunner A**  
**1 Impulsegun (360°)**  
 To Hit: 2D8+ADB  
 Damage: High  
 Range: 3/8/10

**Gunner B**  
**Missile Launcher**  
 (RQL) (R) (RQR)  
 Lock-on < \_\_\_\_\_  
 ○○○○○○ ○○○○○○  
 ○○○○○○ ○○○○○○

**Gunner B**  
**Ion Ram**  
 (RQL) (R) (RQR)  
 To Hit: 2D8+ADB  
 Damage: All  
 Range: 5/13/15  
 Target SR ≤15

### DAMAGE TRACK

|   |   |   |    |   |   |   |   |    |  |    |   |   |
|---|---|---|----|---|---|---|---|----|--|----|---|---|
|   |   |   | 13 |   |   |   |   | W  |  | 12 |   |   |
| w |   |   | 4  | * |   |   |   | 10 |  |    |   |   |
|   | W |   |    |   | 8 | 3 | * |    |  |    |   |   |
|   |   | w |    |   | 6 |   |   |    |  | 2  | * |   |
|   |   |   | w  | 4 |   |   |   |    |  |    |   | 3 |
|   |   |   | 1  |   |   | 2 |   |    |  |    |   |   |
|   |   |   | 1  |   |   |   |   |    |  |    |   |   |

**TPV**

**Pilot**  
**1 Gungnir (F)**  
 To Hit: 2D8+ADB+6  
 Damage: Medium+2 Ⓜ  
 Range: 5/10/16  
 Target SR ≤13

**Crew**  
**PILOT**  
 PIt: \_\_\_\_\_  
 Gnr: \_\_\_\_\_  
 Luck: \_\_\_\_\_  
**GUNNER A**  
 Gnr: \_\_\_\_\_  
**GUNNER B**  
 Gnr: \_\_\_\_\_

**Pilot**  
**Missile Launcher (F)**  
 Lock-on < \_\_\_\_\_  
 ○○○○○○ ○○○○○○  
 ○○○○○○ ○○○○○○

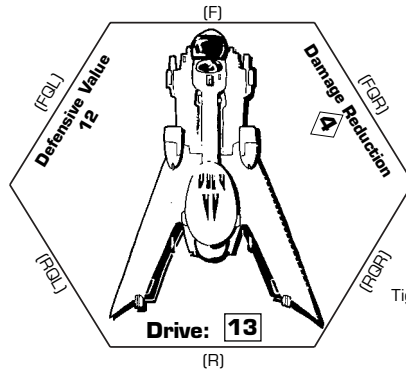

Tight Turn Cost: \_\_\_\_\_+3

Decoys: ○○○○  
 P-D: 1-8 (3)  
 Dmg Con: 1-4  
 Tons: 995

**Gunner A**  
**1 Impulsegun (360°)**  
 To Hit: 2D8+ADB  
 Damage: High  
 Range: 3/8/10

**Gunner B**  
**Missile Launcher**  
 (RQL) (R) (RQR)  
 Lock-on < \_\_\_\_\_  
 ○○○○○○ ○○○○○○  
 ○○○○○○ ○○○○○○

**Gunner B**  
**Ion Ram**  
 (RQL) (R) (RQR)  
 To Hit: 2D8+ADB  
 Damage: All  
 Range: 5/13/15  
 Target SR ≤15

### DAMAGE TRACK

|   |   |   |    |   |   |   |   |    |  |    |   |   |
|---|---|---|----|---|---|---|---|----|--|----|---|---|
|   |   |   | 13 |   |   |   |   | W  |  | 12 |   |   |
| w |   |   | 4  | * |   |   |   | 10 |  |    |   |   |
|   | W |   |    |   | 8 | 3 | * |    |  |    |   |   |
|   |   | w |    |   | 6 |   |   |    |  | 2  | * |   |
|   |   |   | w  | 4 |   |   |   |    |  |    |   | 3 |
|   |   |   | 1  |   |   | 2 |   |    |  |    |   |   |
|   |   |   | 1  |   |   |   |   |    |  |    |   |   |

## CRITICAL HITS

- 2 — **Pilot killed.** Storm may not move, nor may Pilot's weapons fire. Defensive Value drops to 5.
- 3 — **Missile Launcher Destroyed.** Random Missile Launcher is destroyed, and may no longer be used.
- 4 — **Compartment depressurization.** Gunner A killed instantly.
- 5 — **Magnetic fluctuation.** Gungnir may not fire next turn.
- 6 — **Crystantium crack.** Reduce Damage Reduction to 0.
- 7 — **Impulsegun rotator hit.** Impulsegun loses 360° arc. Roll 1D6 to randomly determine what arc weapon is stuck in for remainder of encounter.
- 8 — **Engine hit.** Reduce Drive by 3.
- 9 — **Gungnir Targeter hit.** Modify To Hit by -5.
- 10 — **Wiring short.** Gunner B is electrocuted. Gunner B's weapons may not be fired.
- 11 — **Ionizer short.** Ion Ram may not fire until after next game turn.
- 12 — **Hull fractured.** Storm cracks up into useless space junk.

## GUNGNIR SPECS Ⓜ

Short Range: 1-5 hexes (+1 To Hit).  
 Medium Range: 6-10 hexes.  
 Long Range: 11-16 hexes (-1 To Hit).  
 Target Speed Restriction: Target's Drive value must be ≤13.

Ⓜ May hit all torps in one hex targeting one ship, if at short range.

## IMPULSEGUN SPECS

Short Range: 1-3 hexes (+1 To Hit).  
 Medium Range: 4-8 hexes.  
 Long Range: 9-10 hexes (-1 To Hit).

## ION RAM SPECS

Short Range: 1-5 hexes (+1 To Hit).  
 Medium Range: 6-13 hexes.  
 Long Range: 14-15 hexes (-1 To Hit).  
 Target Speed Restriction: Target's Drive value must be ≤15.

**TPV**

**Mk. 20 Torps**

○ ○  
○ ○  
○ ○

**Mk. 30 Torps**

○ ○  
○ ○  
○ ○

Decoys: ○ ○ ○ ○

P-D: 1-8 (6)  
Dmg Con: 1-8  
Tons: 1501

**Gunner C**

**1 Ion Ram**  
(RQL) (FQL) (F)  
To Hit: 2D8+ADB  
Damage: All  
Range: 5/13/15  
Target SR ≤15

**LEFT SIDE DAMAGE TRACK**

|   |   |   |   |    |   |   |    |
|---|---|---|---|----|---|---|----|
|   |   |   |   |    | t |   |    |
|   |   | 5 | T |    |   |   |    |
|   | 4 |   | t | -1 | * | w |    |
|   |   |   |   |    |   | 3 |    |
|   |   |   | t |    |   |   | -1 |
|   | 2 | W | T | *  |   |   | ×  |
| 1 |   | t | w |    |   |   |    |
|   |   |   |   |    |   |   | ×  |

**Pilot**

**1 Gungnir (F)**  
To Hit: 2D8+ADB+6  
Damage: Medium+2 ∂  
Range: 5/10/16  
Target SR ≤13

**Gunner A**

**1 Mjöltnir**  
(FQL) (F) (FQR)  
To Hit: 2D8+ADB+6  
Damage: Low+3 ∂  
Range: 3/7/10

**Gunner B**

**4 Autocannons (360°)**  
To Hit: 2D6+ADB+3  
Damage: Medium+3 †  
Range: 3/10/24  
Target SR ≤10

○ ○ ○ ○ ○ ○ ○ ○

**Gunner A**

**Missile Launcher**  
(FQL) (F) (FQR)  
Lock-on < \_\_\_\_

○ ○ ○ ○ ○ ○ ○ ○ ○ ○ ○ ○ ○ ○

**Crew**

**PILOT**  
Plt: \_\_\_\_\_  
Gnr: \_\_\_\_\_  
Luck: \_\_\_\_\_

**GUNNER A**  
Gnr: \_\_\_\_\_

**GUNNER B**  
Gnr: \_\_\_\_\_

**GUNNER C**  
Gnr: \_\_\_\_\_

**GUNNER D**  
Gnr: \_\_\_\_\_

**GUNNER E**  
Gnr: \_\_\_\_\_

**FRONT DAMAGE TRACK**

|   |   |   |   |   |  |   |   |  |   |   |  |   |
|---|---|---|---|---|--|---|---|--|---|---|--|---|
|   |   |   |   |   |  |   | t |  | w | 5 |  |   |
|   |   | T |   | * |  |   | 4 |  |   | w |  |   |
|   | t |   |   | 3 |  | W |   |  |   | T |  |   |
|   |   | 2 | * |   |  |   | w |  |   | t |  | × |
| 1 |   | T |   |   |  |   |   |  |   | t |  | × |

**Gunner D**

**1 Ion Ram**  
(F) (FQR) (RQR)  
To Hit: 2D8+ADB  
Damage: All  
Range: 5/13/15  
Target SR ≤15

**Defensive Value 11**

(FQL) (FQR) (RQL) (RQR)

**Drive: 11**

(R)

**RIGHT SIDE DAMAGE TRACK**

|   |   |   |   |    |   |   |    |
|---|---|---|---|----|---|---|----|
|   |   |   |   |    | t |   |    |
|   |   | 5 | T |    |   |   |    |
|   | 4 |   | t | -1 | * | w |    |
|   |   |   |   |    |   | 3 |    |
|   |   |   | t |    |   |   | -1 |
|   | 2 | W | T | *  |   |   | ×  |
| 1 |   | t | w |    |   |   |    |
|   |   |   |   |    |   |   | ×  |

**Gunner E**

**1 Mjöltnir**  
(RQL) (R) (RQR)  
To Hit: 2D8+ADB+6  
Damage: Low+3 ∂  
Range: 3/7/10

Tight Turn Cost:  
\_\_\_\_\_+4

**Gunner E**

**Missile Launcher**  
(RQL) (R) (RQR)  
Lock-on < \_\_\_\_

○ ○ ○ ○ ○ ○ ○ ○ ○ ○ ○ ○ ○ ○

**REAR DAMAGE TRACK**

|   |  |    |    |   |    |   |    |   |    |   |    |   |    |   |   |    |    |    |   |
|---|--|----|----|---|----|---|----|---|----|---|----|---|----|---|---|----|----|----|---|
|   |  |    | -1 |   | 5  |   | -1 |   | t  |   | -1 | 4 | w  |   | t |    | -1 | *  |   |
| 3 |  | -1 |    | t | -1 | × | 2  | W | -1 | * |    | T | -1 | 1 | w | -1 |    | -1 | × |

- FRONT CRITICAL HITS**
- Gunner A killed.
  - Torp Targeter short. Torps may not be fired until after next turn.
  - Praise St. Brawn! No damage.
  - Gauss generator hit. Gungnir is -2 to all damage.
  - Autocannon jam. May not fire until after next game turn. Lose 1 ammo.
  - Severe frame damage. 4 hits to each track.
  - Pilot killed. Iceberg may not move or fire Pilot's weapons until after next game turn.

- LEFT SIDE CRITICAL HITS**
- Gunner C killed.
  - Targeting damaged. Ion Ram is -2 to hit and damage.
  - Shielding penetrated. Reduce Defensive Value by 2.
  - Gauss Generator short. Mjöltnir and Gungnir may not fire until after next game turn.
  - Structural damage. Take 1D4 hits on each Damage Track.
  - Autocannon hit. Autocannon is at -2 To Hit, and loses 1D4 ammo.
  - Point Defense compromised. Iceberg may no longer use P-D against torps or missiles.

- RIGHT SIDE CRITICAL HITS**
- Gunner D killed.
  - Targeting damaged. Ion Ram is -2 to hit and damage.
  - Shielding penetrated. Reduce Defensive Value by 2.
  - Gauss Generator short. Mjöltnir and Gungnir may not fire until after next game turn.
  - Structural damage. Take 1D4 hits on each Damage Track.
  - Autocannon hit. Autocannon is at -2 To Hit, and loses 1D4 ammo.
  - Point Defense compromised. Iceberg may no longer use P-D against torps or missiles.

- REAR CRITICAL HITS**
- Gunner E killed.
  - Missile Launcher E hit. Lose 1D8 missiles.
  - Engine sputter. Reduce Drive by 4 next turn only.
  - Maneuvering thrusters hit. All turns cost 1 extra point to perform.
  - Electronic Warfare crippled. Iceberg may no longer jam torps.
  - Torp detonates. 2D12 damage (no damage if all torps are gone.)
  - Iceberg reactor hit. The gates of Valhalla swing open wide for this brave crew.

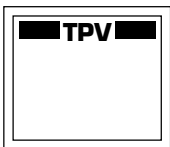

**Gunner A**  
**Missile Launcher**  
 (BRQL) (BFQL) (F)  
 Lock-on < \_\_\_  
 ○ ○ ○ ○ ○  
 ○ ○ ○ ○ ○  
 ○ ○ ○ ○ ○  
 ○ ○ ○ ○ ○

**Gunner A**  
 ○

∂ May hit all torps in one hex targeting one ship, if at short range.

**Gunner A**  
**4 Splatterguns**  
 (BRQL) (BFQL) (F)  
 (BFQR) (BRQR)  
 To Hit: 2D6+ADB+3  
 Damage: Medium+6  
 Range: 2/6/10

**Gun Crew G**  
**1 Laztube** ○○○  
 (BRQL) (BFQL) (F)  
 (BFQR) (BRQR)  
 To Hit: 2D10+ADB  
 Damage: High x 2  
 Range: 10/20/40  
 Target SR ≤8

**Gun Crew F**  
**Bifrost Cannon (KF)**  
 ○○○○○  
 To Hit: 2D10+ADB+10  
 Damage: All x 2 ∂  
 Range: 10/20/30

**Gunner C**  
**1 Mjölmir**  
 ○  
 (BRQL) (BFQL) (F)  
 (BFQR) (BRQR)  
 To Hit: 2D8+ADB+6  
 Damage: Low+3 ∂  
 Range: 3/7/10

**Gunner B**  
**4 Splatterguns**  
 (BRQL) (BFQL) (F)  
 (BFQR) (BRQR)  
 To Hit: 2D6+ADB+3  
 Damage: Medium+6  
 Range: 2/6/10

**Gun Crew H**  
**1 Laztube** ○○○  
 (BRQL) (BFQL) (F)  
 (BFQR) (BRQR)  
 To Hit: 2D10+ADB  
 Damage: High x 2  
 Range: 10/20/40  
 Target SR ≤8

**Gunner B**  
**Missile Launcher**  
 (F) (BFQR) (BRQR)  
 Lock-on < \_\_\_  
 ○ ○ ○ ○ ○  
 ○ ○ ○ ○ ○  
 ○ ○ ○ ○ ○  
 ○ ○ ○ ○ ○

**Gunner B**  
 ○

**Crew**  
**CAPTAIN**  
 Cpn: \_\_\_\_\_  
**PILOT**  
 Plt: \_\_\_\_\_  
**GUNNER A**  
 Gnr: \_\_\_\_\_  
**GUNNER B**  
 Gnr: \_\_\_\_\_  
**GUNNER C**  
 Gnr: \_\_\_\_\_  
**GUNNER D**  
 Gnr: \_\_\_\_\_  
**GUNNER E**  
 Gnr: \_\_\_\_\_  
**CREW F**  
 Gnr: \_\_\_\_\_  
**CREW G**  
 Gnr: \_\_\_\_\_  
**CREW H**  
 Gnr: \_\_\_\_\_  
**T CREW I**  
 Gnr: \_\_\_\_\_  
**T CREW J**  
 Gnr: \_\_\_\_\_

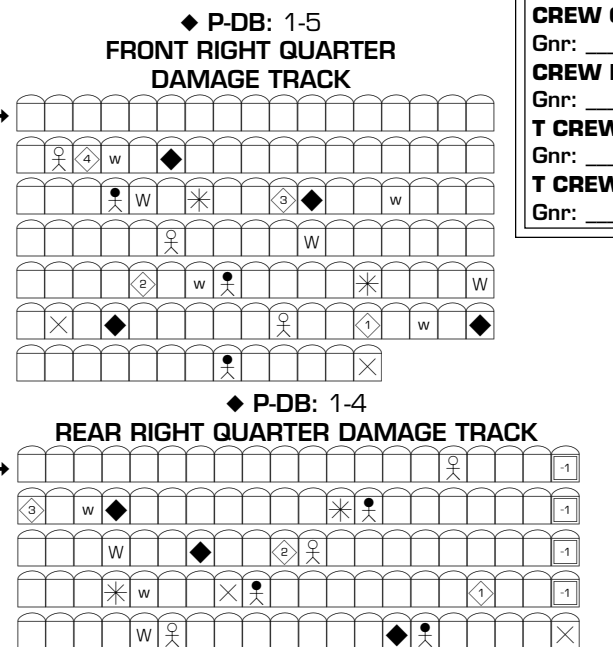
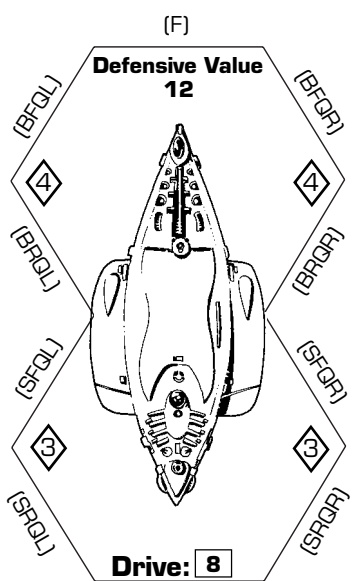
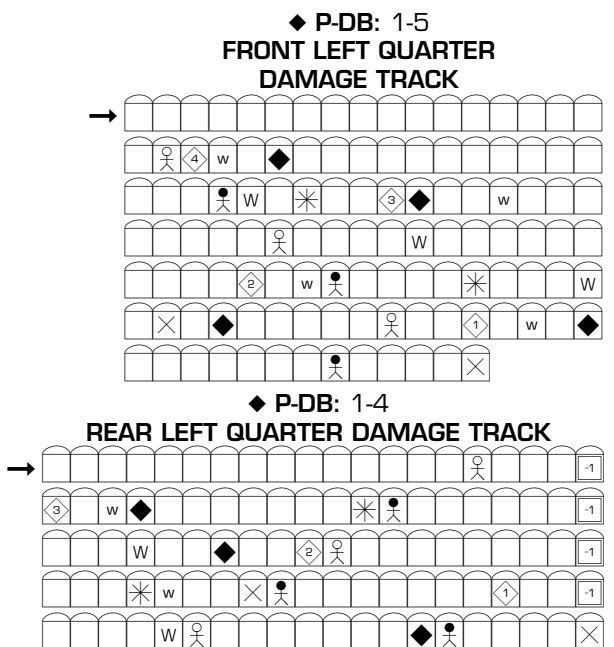

**Gunner D**  
**Missile Launcher**  
 (SFQL) (SRQL) (R)  
 Lock-on < \_\_\_  
 ○ ○ ○ ○ ○  
 ○ ○ ○ ○ ○  
 ○ ○ ○ ○ ○  
 ○ ○ ○ ○ ○

**Gunner D**  
 ○

**Gunner D**  
**2 Splatterguns**  
 (SFQL) (SRQL) (R)  
 To Hit: 2D8+ADB+1  
 Damage: Medium+2  
 Range: 2/6/10

**Gun Crew I**  
**2 Torpedo Tubes**  
 ○○○  
 (SFQR)

**Gun Crew J**  
**2 Torpedo Tubes**  
 ○○○  
 (SFQR)

**Gunner E**  
 ○

**Gunner E**  
**2 Splatterguns**  
 (R) (SRQR) (SFQR)  
 To Hit: 2D8+ADB+1  
 Damage: Medium+2  
 Range: 2/6/10

**Gunner E**  
**Missile Launcher**  
 (R) (SRQR) (SFQR)  
 Lock-on < \_\_\_  
 ○ ○ ○ ○ ○  
 ○ ○ ○ ○ ○  
 ○ ○ ○ ○ ○  
 ○ ○ ○ ○ ○



## FRONT LEFT CRITICAL HITS

- 2 — **ECM destroyed.** Longboat may no longer jam torps.
- 3 — **Capacitor malfunction.** Bow Laztubes, Mjólnir, and Bifrost Cannon may not fire until after next game turn.
- 4 — **Splattergun jam.** Gunner A's Splattergun may not fire until after next game turn.
- 5 — **TOC Room power flux.** TOC bonus may not be added next turn.
- 6 — **Bifrost Cannon control room hit.** Lose 1D4 Bifrost Cannon crew.
- 7 — **Splattergun destroyed.** Gunner A's Splattergun is destroyed.
- 8 — **ECM malfunction.** Longboat may not screen until after next game turn.
- 9 — **Minor structural damage.** Take 10 more hits on this track
- 10 — **Laztube overload.** Laztube G is destroyed, and crew is killed. 1D12 hits on this track.
- 11 — **Mjólnir hit.** Mjólnir is destroyed and gunner is killed.
- 12 — **Bridge hit!** Bridge crew is stunned. Longboat may not move until next turn and may not add TOC bonus to initiative.

## REAR LEFT CRITICAL HITS

- 2 — **Bridge hit!** The captain is killed. Longboat may no longer use Captain die.
- 3 — **TOC destroyed.** Longboat may no longer add TOC bonus to initiative roll.
- 4 — **Missile Rack hit.** Lose 1D10 missiles from Gunner D's rack.
- 5 — **Engine hit.** Reduce Drive by 2.
- 6 — **Torpedo Defense damaged.** Longboat may no longer jam torps.
- 7 — **Magnetic fluctuation.** All Gauss weapons may not be fired until next game turn.
- 8 — **Gunner D killed.** Gunner D's weapons may not be fired.
- 9 — **Shield Generator short.** Longboat's Defensive Value is reduced by 6 until after next game turn.
- 10 — **Torpedo Magazine hit.** Lose D4 of each type of torp.
- 11 — **Life support malfunction.** 1D4 crew killed.
- 12 — **Plasma Core meltdown.** The Longboat briefly becomes a tiny sun and then is no more.

# LONGBOAT

Tons: 11000

### Electronics

Jam: 1-2 on 1D4

ECM: 1-4

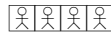

### Bridge

Captain: \_\_\_\_\_

Pilot: \_\_\_\_\_

TOC: +2

### Engineering

Damage Control: 1-6



Mk. 10

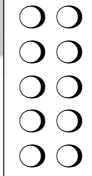

Mk. 30

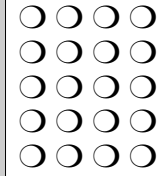

Mk. 70

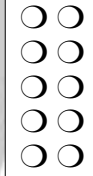

Stern Torpedo  
Magazine

## FRONT RIGHT CRITICAL HITS

- 2 — **ECM destroyed.** Longboat may no longer jam torps.
- 3 — **Capacitor malfunction.** Bow Laztubes, Mjólnir, and Bifrost Cannon may not fire until after next game turn.
- 4 — **Splattergun jam.** Gunner B's Splattergun may not fire until after next game turn.
- 5 — **TOC Room power flux.** TOC bonus may not be added next turn.
- 6 — **Bifrost Cannon control room hit.** Lose 1D4 Bifrost Cannon crew.
- 7 — **Splattergun destroyed.** Gunner B's Splattergun is destroyed.
- 8 — **ECM malfunction.** Longboat may not screen until after next game turn.
- 9 — **Minor structural damage.** Take 10 more hits on this track
- 10 — **Laztube overload.** Laztube H is destroyed, and crew is killed. 1D12 hits on this track.
- 11 — **Mjólnir hit.** Mjólnir is destroyed and gunner is killed.
- 12 — **Bridge hit!** Bridge crew is stunned. Longboat may not move until next turn and may not add TOC bonus to initiative.

## REAR RIGHT CRITICAL HITS

- 2 — **Bridge hit!** The captain is killed. Longboat may no longer use Captain die.
- 3 — **TOC destroyed.** Longboat may no longer add TOC bonus to initiative roll.
- 4 — **Missile Rack hit.** Lose 1D10 missiles from Gunner E's rack.
- 5 — **Engine hit.** Reduce Drive by 2.
- 6 — **Torpedo Defense damaged.** Longboat may no longer jam torps.
- 7 — **Magnetic fluctuation.** All Gauss weapons may not be fired until next game turn.
- 8 — **Gunner E killed.** Gunner E's weapons may not be fired.
- 9 — **Shield Generator short.** Longboat's Defensive Value is reduced by 6 until after next game turn.
- 10 — **Torpedo Magazine hit.** Lose D4 of each type of torp.
- 11 — **Life support malfunction.** 1D4 crew killed.
- 12 — **Plasma Core meltdown.** The Longboat briefly becomes a tiny sun and then is no more.

**TPV**

**Pilot**  
**1 Plazgun (F)**  
 To Hit: 2D6+ADB  
 Damage: All ¥  
 Range: 2/4/10

**Crew**  
**PILOT**  
 Pit: \_\_\_\_\_  
 Gnr: \_\_\_\_\_  
 Luck: \_\_\_\_\_  
**GUNNER**  
 Gnr: \_\_\_\_\_

**Mk. 40 Torps**

○  
○

**Pilot**  
**1 Gungnir (F)**  
 To Hit: 2D8+ADB+6  
 Damage: Medium+2 ∂  
 Range: 5/10/16  
 Target SR ≤13

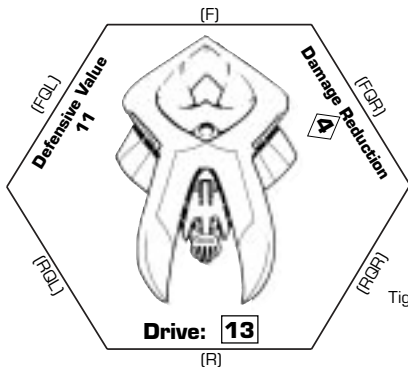

Decoys: ○○○○  
 P-D: 1-6 (2)  
 Dmg Con: 1-6  
 Tons: 900

**Gunner**  
**1 Splattergun**  
 (RQL) (R) (RQR)  
 To Hit: 2D6+ADB  
 Damage: Medium  
 Range: 2/6/10

**Gunner**  
**Missile Launcher (360°)**  
 Lock-on < \_\_\_\_\_

○○○○○ ○○○○○  
 ○○○○○ ○○○○○

DAMAGE TRACK

|    |   |   |   |    |   |    |   |   |  |   |
|----|---|---|---|----|---|----|---|---|--|---|
|    |   |   | 4 |    | * | 12 |   | w |  |   |
| 11 | 3 | w |   | 10 |   | t  |   | 9 |  |   |
| W  |   | 2 |   | 8  |   | w  |   |   |  |   |
| 7  |   | * |   |    | 1 |    | 6 | * |  |   |
| w  |   | t |   | 5  |   |    |   |   |  | 4 |
|    |   | 3 |   | 2  |   | 1  |   |   |  |   |
|    |   |   |   |    |   |    |   |   |  | × |

**TPV**

**Pilot**  
**1 Plazgun (F)**  
 To Hit: 2D6+ADB  
 Damage: All ¥  
 Range: 2/4/10

**Crew**  
**PILOT**  
 Pit: \_\_\_\_\_  
 Gnr: \_\_\_\_\_  
 Luck: \_\_\_\_\_  
**GUNNER**  
 Gnr: \_\_\_\_\_

**Mk. 40 Torps**

○  
○

**Pilot**  
**1 Gungnir (F)**  
 To Hit: 2D8+ADB+6  
 Damage: Medium+2 ∂  
 Range: 5/10/16  
 Target SR ≤13

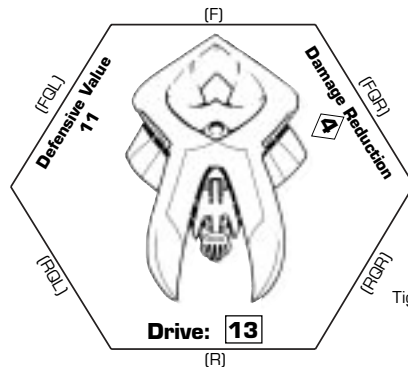

Decoys: ○○○○  
 P-D: 1-6 (2)  
 Dmg Con: 1-6  
 Tons: 900

**Gunner**  
**1 Splattergun**  
 (RQL) (R) (RQR)  
 To Hit: 2D6+ADB  
 Damage: Medium  
 Range: 2/6/10

**Gunner**  
**Missile Launcher (360°)**  
 Lock-on < \_\_\_\_\_

○○○○○ ○○○○○  
 ○○○○○ ○○○○○

DAMAGE TRACK

|    |   |   |   |    |   |    |   |   |  |   |
|----|---|---|---|----|---|----|---|---|--|---|
|    |   |   | 4 |    | * | 12 |   | w |  |   |
| 11 | 3 | w |   | 10 |   | t  |   | 9 |  |   |
| W  |   | 2 |   | 8  |   | w  |   |   |  |   |
| 7  |   | * |   |    | 1 |    | 6 | * |  |   |
| w  |   | t |   | 5  |   |    |   |   |  | 4 |
|    |   | 3 |   | 2  |   | 1  |   |   |  |   |
|    |   |   |   |    |   |    |   |   |  | × |

### CRITICAL HITS

- 2 — Crew killed. Glaive may perform no further actions. Defensive Value drops to 5.
- 3 — Major Structural Damage inflicted. Mark off 2D10 more hits of damage.
- 4 — Electronic Warfare lost. Glaive may no longer jam torps. Reduce Defensive Value by 2.
- 5 — Maneuver Thrusters damaged. All turns cost 1 extra point to perform. Reduce Defensive Value by 2.
- 6 — Shields damaged. Reduce Defensive Value by 1.
- 7 — Armor too tough! No extra damage.
- 8 — Gungnir short. It may not fire for one turn.
- 9 — Missile Launcher damaged. Lose 1D8 of remaining missiles in one (random) functioning Missile Launcher.
- 10 — Plazgun Targeter damaged. Reduce To Hit chance by 2.
- 11 — Controls lock up. Glaive may not move nor fire cannons until after next game turn. Reduce Defensive Value to 5 during this period.
- 12 — Catastrophic Structural Collapse. Glaive dissolves.

### GUNGNIR SPECS ∂

Short Range: 1-5 hexes (+1 To Hit).  
 Medium Range: 6-10 hexes.  
 Long Range: 11-16 hexes (-1 To Hit).  
 Target Speed Restriction: Target's Drive value must be ≤13.

∂ May hit all torps in one hex targeting one ship, if at short range.

### PLAZGUN SPECS ¥

Short Range: 1-2 hexes (+1 To Hit).  
 Medium Range: 3-4 hexes.  
 Long Range: 5-10 hexes (-1 To Hit).

### SPLATTERGUN SPECS

Short Range: 1-2 hexes (+1 To Hit).  
 Medium Range: 3-6 hexes.  
 Long Range: 7-10 hexes (-1 To Hit).

**TPV**

**Gunner A Missile Launcher (360°)**  
Lock-on < \_\_\_\_\_

|   |   |   |   |   |   |   |   |   |   |
|---|---|---|---|---|---|---|---|---|---|
| ○ | ○ | ○ | ○ | ○ | ○ | ○ | ○ | ○ | ○ |
| ○ | ○ | ○ | ○ | ○ | ○ | ○ | ○ | ○ | ○ |
| ○ | ○ | ○ | ○ | ○ | ○ | ○ | ○ | ○ | ○ |
| ○ | ○ | ○ | ○ | ○ | ○ | ○ | ○ | ○ | ○ |

**Gun Crew E 2 Torpedo Tubes (360°)**

**Mk. 40 Torps**

|   |   |
|---|---|
| ○ | ○ |
| ○ | ○ |
| ○ | ○ |
| ○ | ○ |
| ○ | ○ |
| ○ | ○ |

**Gunner A 2 Splatterguns (360°)**  
To Hit: 2D6+ADB+1  
Damage: Medium+2  
Range: 2/6/10

**Gunner A**

**FQL DAMAGE TRACK**  
P-DB: 1-4

|   |   |   |   |   |   |   |   |   |   |
|---|---|---|---|---|---|---|---|---|---|
| □ | □ | □ | □ | □ | □ | □ | □ | □ | □ |
| * | ◇ | ◇ | ◇ | ◇ | ◇ | ◇ | ◇ | ◇ | ◇ |
| × | * | ◇ | ◇ | ◇ | ◇ | ◇ | ◇ | ◇ | × |

**RQL DAMAGE TRACK**  
P-DB: 1-4

|   |   |   |   |   |   |   |   |   |   |
|---|---|---|---|---|---|---|---|---|---|
| □ | □ | □ | □ | □ | □ | □ | □ | □ | □ |
| * | ◇ | ◇ | ◇ | ◇ | ◇ | ◇ | ◇ | ◇ | ◇ |
| × | * | ◇ | ◇ | ◇ | ◇ | ◇ | ◇ | ◇ | × |

**Gunner B 1 Turbo Laser (360°)**  
To Hit: 2D8+ADB  
Damage: High  
Range: 9/25/30  
Target SR ≤8

**Gunner B**

**FRONT DAMAGE TRACK**  
P-DB: 1-4

|   |   |   |   |   |   |   |   |   |   |
|---|---|---|---|---|---|---|---|---|---|
| □ | □ | □ | □ | □ | □ | □ | □ | □ | □ |
| * | ◇ | ◇ | ◇ | ◇ | ◇ | ◇ | ◇ | ◇ | ◇ |
| × | * | ◇ | ◇ | ◇ | ◇ | ◇ | ◇ | ◇ | × |

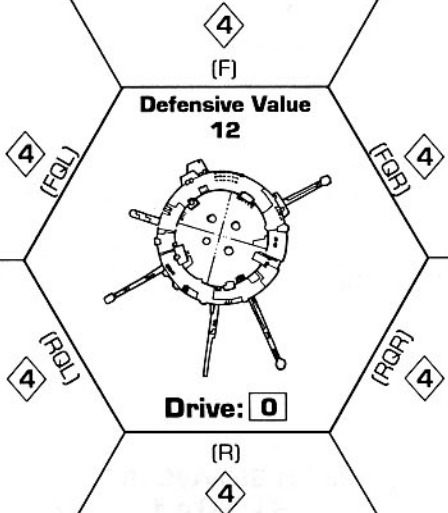

**REAR DAMAGE TRACK**  
P-DB: 1-4

|   |   |   |   |   |   |   |   |   |   |
|---|---|---|---|---|---|---|---|---|---|
| □ | □ | □ | □ | □ | □ | □ | □ | □ | □ |
| * | ◇ | ◇ | ◇ | ◇ | ◇ | ◇ | ◇ | ◇ | ◇ |
| × | * | ◇ | ◇ | ◇ | ◇ | ◇ | ◇ | ◇ | × |

**Gunner C 2 Meld Lasers (360°)**  
To Hit: 2D8+ADB+1  
Damage: Medium+1  
Range: 6/18/20  
Target SR ≤12

**Gunner C**

**FQR DAMAGE TRACK**  
P-DB: 1-4

|   |   |   |   |   |   |   |   |   |   |
|---|---|---|---|---|---|---|---|---|---|
| □ | □ | □ | □ | □ | □ | □ | □ | □ | □ |
| * | ◇ | ◇ | ◇ | ◇ | ◇ | ◇ | ◇ | ◇ | ◇ |
| × | * | ◇ | ◇ | ◇ | ◇ | ◇ | ◇ | ◇ | × |

**RQR DAMAGE TRACK**  
P-DB: 1-4

|   |   |   |   |   |   |   |   |   |   |
|---|---|---|---|---|---|---|---|---|---|
| □ | □ | □ | □ | □ | □ | □ | □ | □ | □ |
| * | ◇ | ◇ | ◇ | ◇ | ◇ | ◇ | ◇ | ◇ | ◇ |
| × | * | ◇ | ◇ | ◇ | ◇ | ◇ | ◇ | ◇ | × |

**Gunner D 2 Splatterguns (360°)**  
To Hit: 2D6+ADB+1  
Damage: Medium+2  
Range: 2/6/10

**Gunner D**

**Gunner D Missile Launcher (360°)**  
Lock-on < \_\_\_\_\_

|   |   |   |   |   |   |   |   |   |   |
|---|---|---|---|---|---|---|---|---|---|
| ○ | ○ | ○ | ○ | ○ | ○ | ○ | ○ | ○ | ○ |
| ○ | ○ | ○ | ○ | ○ | ○ | ○ | ○ | ○ | ○ |

**Crew**  
**GUNNER A**  
Gnr: \_\_\_\_\_  
**GUNNER B**  
Gnr: \_\_\_\_\_  
**GUNNER C**  
Gnr: \_\_\_\_\_  
**GUNNER D**  
Gnr: \_\_\_\_\_  
**T CREW E**  
Gnr: \_\_\_\_\_

**TBD HITS**

|   |   |   |   |   |   |   |   |   |   |
|---|---|---|---|---|---|---|---|---|---|
| □ | □ | □ | □ | □ | □ | □ | □ | □ | □ |
| □ | □ | □ | □ | □ | □ | □ | □ | □ | □ |

**Dmg Con: 1-8 Tons: 2000**

**FRONT CRITICAL HITS**

- Sensor Array hit. Reduce chance To Hit for all weapons by 1.
- Shield buckles. Reduce Defensive Value by 3.
- Severe TBD damage. TBD takes two hits.
- Rotator System hit. Twin Meld Laser loses 360° arc. Roll 1D6 to randomly determine in which arc weapon is stuck for the rest of encounter.
- Torp Bay hit. Lose 1D4 torps.
- Meld Laser Targeting damaged. Reduce chance To Hit by 1.
- TBD reactor hit. TBD is destroyed.

**FQL CRITICAL HITS**

- Gunner A killed.
- Electronic warfare damaged. Reduce Defensive Value by 1.
- Shield buckles. Reduce Defensive Value by 3.
- Rotator System hit. Twin Meld Laser loses 360° arc. Roll 1D6 to randomly determine in which arc weapon is stuck for the rest of encounter.
- Missile Rack hit. Lose 1D6 missiles from Gunner A's rack.
- Gunner A's Splattergun hit. Reduce chance To Hit by 1.
- TBD reactor hit. TBD is destroyed.

**FQR CRITICAL HITS**

- Gunner C killed.
- Shield buckles. Reduce Defensive Value by 3.
- Severe TBD damage. TBD takes two hits.
- Rotator System hit. Twin Meld Laser loses 360° arc. Roll 1D6 to randomly determine in which arc weapon is stuck for the rest of encounter.
- Torp Bay hit. Lose 1D4 torps.
- Meld Laser Targeting damaged. Reduce chance To Hit by 1.
- TBD reactor hit. TBD is destroyed.

**RQL CRITICAL HITS**

- Torpedo detonates. Torp is destroyed; does 1D4 to each damage track, ignoring DR.
- Turbo Laser Targeting damaged. Reduce chance To Hit by 1.
- Structural damage. Take 3 hits on all damage tracks.
- Rotator System hit. Turbo Laser loses 360° arc. Roll 1D6 to randomly determine in which arc weapon is stuck for the rest of encounter.
- Torp Tube destroyed.
- Clank! Armor too tough! No extra damage.
- TBD reactor hit. TBD destroyed.

**RQR CRITICAL HITS**

- Gunner D killed.
- Electronic warfare crippled. Reduce Defensive Value by 1.
- Severe TBD damage. TBD takes two hits.
- Rotator System hit. Twin Meld Laser loses 360° arc. Roll 1D6 to randomly determine in which arc weapon is stuck for the rest of encounter.
- Missile Rack hit. Lose 1D6 missiles from Gunner D's rack.
- Gunner D's Splattergun hit. Reduce chance To Hit by 1.
- TBD reactor hit. TBD is destroyed.

**REAR CRITICAL HITS**

- Gunner B killed.
- Turbo Laser Targeting damaged. Reduce chance To Hit by 1.
- Structural damage. Take 3 hits on all damage tracks.
- Rotator System hit. Twin Meld Laser loses 360° arc. Roll 1D6 to randomly determine in which arc weapon is stuck for the rest of encounter.
- Torp Tube destroyed.
- Clank! No damage. Armor is too tough.
- TBD reactor hit. TBD is destroyed.

**BPV: 20 I.D. SPIRIT RIDER III**

**TPV**

**Pilot**  
**4 Splatterguns (F)**  
 To Hit: 2D6+ADB+3  
 Damage: Medium+6  
 Range: 2/6/10

**Crew**  
**PILOT**  
 Plt: \_\_\_\_\_  
 Gnr: \_\_\_\_\_  
 Luck: \_\_\_\_\_

Decoys: ○  
 P-D: —  
 Dmg Con: 1-3  
 Tons: 125

Tight Turn Cost: \_\_\_\_\_+3

**DAMAGE TRACK**

|   |   |   |    |   |   |   |    |
|---|---|---|----|---|---|---|----|
| → |   |   | 15 |   |   | 2 | 12 |
|   | 1 | 9 | w  | * | 6 | 2 | ×  |

**BPV: 20 I.D. SPIRIT RIDER III**

**TPV**

**Pilot**  
**4 Splatterguns (F)**  
 To Hit: 2D6+ADB+3  
 Damage: Medium+6  
 Range: 2/6/10

**Crew**  
**PILOT**  
 Plt: \_\_\_\_\_  
 Gnr: \_\_\_\_\_  
 Luck: \_\_\_\_\_

Decoys: ○  
 P-D: —  
 Dmg Con: 1-3  
 Tons: 125

Tight Turn Cost: \_\_\_\_\_+3

**DAMAGE TRACK**

|   |   |   |    |   |   |   |    |
|---|---|---|----|---|---|---|----|
| → |   |   | 15 |   |   | 2 | 12 |
|   | 1 | 9 | w  | * | 6 | 2 | ×  |

**BPV: 20 I.D. SPIRIT RIDER III**

**TPV**

**Pilot**  
**4 Splatterguns (F)**  
 To Hit: 2D6+ADB+3  
 Damage: Medium+6  
 Range: 2/6/10

**Crew**  
**PILOT**  
 Plt: \_\_\_\_\_  
 Gnr: \_\_\_\_\_  
 Luck: \_\_\_\_\_

Decoys: ○  
 P-D: —  
 Dmg Con: 1-3  
 Tons: 125

Tight Turn Cost: \_\_\_\_\_+3

**DAMAGE TRACK**

|   |   |   |    |   |   |   |    |
|---|---|---|----|---|---|---|----|
| → |   |   | 15 |   |   | 2 | 12 |
|   | 1 | 9 | w  | * | 6 | 2 | ×  |

**BPV: 20 I.D. SPIRIT RIDER III**

**TPV**

**Pilot**  
**4 Splatterguns (F)**  
 To Hit: 2D6+ADB+3  
 Damage: Medium+6  
 Range: 2/6/10

**Crew**  
**PILOT**  
 Plt: \_\_\_\_\_  
 Gnr: \_\_\_\_\_  
 Luck: \_\_\_\_\_

Decoys: ○  
 P-D: —  
 Dmg Con: 1-3  
 Tons: 125

Tight Turn Cost: \_\_\_\_\_+3

**DAMAGE TRACK**

|   |   |   |    |   |   |   |    |
|---|---|---|----|---|---|---|----|
| → |   |   | 15 |   |   | 2 | 12 |
|   | 1 | 9 | w  | * | 6 | 2 | ×  |

**CRITICAL HITS**

- 2 — **Pilot killed.** Spirit Rider may perform no further actions. Defensive Value drops to 5.
- 3 — **Engines destroyed.** Spirit Rider may not move or turn. Reduce Defensive Value to 5.
- 4 — **Electronic Warfare knocked out.** Spirit Rider may no longer jam torps. Reduce Defensive Value by 5.
- 5 — **Maneuver Thrusters hit.** Spirit Rider may no longer turn.
- 6 — **Shields damaged.** Reduce Defensive Value by 2.
- 7 — **Splattergun Targeters hit.** Reduce chance To Hit by 2.
- 8 — **Evade Thrusters hit.** Reduce Defensive Value by 3.
- 9 — **Hull compromised.** Reduce Defensive Value by 4.
- 10 — **Engines severely damaged.** Spirit Rider reduced to a Drive value of 1. Reduce Defensive Value by 7.
- 11 — **Pilot dazed.** Spirit Rider may not move or fire until after the next game turn.
- 12 — **Reactor hit.** Power supply detonates; Spirit Rider is destroyed.

**SPLATTERGUN SPECS**

Short Range: 1-2 hexes (+1 To Hit).  
 Medium Range: 3-6 hexes.  
 Long Range: 7-10 hexes (-1 To Hit).

**BPV: 17** **I.D.** **PIT VIPER II**

**TPV**

**Mk. 30 Torps**

Decoys: ○  
P-D: —  
Dmg Con: 1-2  
Tons: 90

**Pilot**  
2 Pulse Lasers (F)  
To Hit: 2D8+ADB+1  
Damage: Low+1  
Range: 3/9/10

**Crew**  
**PILOT**  
Plt: \_\_\_\_\_  
Gnr: \_\_\_\_\_  
Luck: \_\_\_\_\_

Defensive Value 15  
Damage Reduction 2  
Drive: 18  
Tight Turn Cost: \_\_\_\_\_+3

DAMAGE TRACK

|    |   |   |    |   |
|----|---|---|----|---|
| 18 | 2 | * | 15 | 1 |
| 8  | 4 | w | 1  | × |

**BPV: 17** **I.D.** **PIT VIPER II**

**TPV**

**Mk. 30 Torps**

Decoys: ○  
P-D: —  
Dmg Con: 1-2  
Tons: 90

**Pilot**  
2 Pulse Lasers (F)  
To Hit: 2D8+ADB+1  
Damage: Low+1  
Range: 3/9/10

**Crew**  
**PILOT**  
Plt: \_\_\_\_\_  
Gnr: \_\_\_\_\_  
Luck: \_\_\_\_\_

Defensive Value 15  
Damage Reduction 2  
Drive: 18  
Tight Turn Cost: \_\_\_\_\_+3

DAMAGE TRACK

|    |   |   |    |   |
|----|---|---|----|---|
| 18 | 2 | * | 15 | 1 |
| 8  | 4 | w | 1  | × |

**BPV: 17** **I.D.** **PIT VIPER II**

**TPV**

**Mk. 30 Torps**

Decoys: ○  
P-D: —  
Dmg Con: 1-2  
Tons: 90

**Pilot**  
2 Pulse Lasers (F)  
To Hit: 2D8+ADB+1  
Damage: Low+1  
Range: 3/9/10

**Crew**  
**PILOT**  
Plt: \_\_\_\_\_  
Gnr: \_\_\_\_\_  
Luck: \_\_\_\_\_

Defensive Value 15  
Damage Reduction 2  
Drive: 18  
Tight Turn Cost: \_\_\_\_\_+3

DAMAGE TRACK

|    |   |   |    |   |
|----|---|---|----|---|
| 18 | 2 | * | 15 | 1 |
| 8  | 4 | w | 1  | × |

**BPV: 17** **I.D.** **PIT VIPER II**

**TPV**

**Mk. 30 Torps**

Decoys: ○  
P-D: —  
Dmg Con: 1-2  
Tons: 90

**Pilot**  
2 Pulse Lasers (F)  
To Hit: 2D8+ADB+1  
Damage: Low+1  
Range: 3/9/10

**Crew**  
**PILOT**  
Plt: \_\_\_\_\_  
Gnr: \_\_\_\_\_  
Luck: \_\_\_\_\_

Defensive Value 15  
Damage Reduction 2  
Drive: 18  
Tight Turn Cost: \_\_\_\_\_+3

DAMAGE TRACK

|    |   |   |    |   |
|----|---|---|----|---|
| 18 | 2 | * | 15 | 1 |
| 8  | 4 | w | 1  | × |

- CRITICAL HITS**
- 2 — **Pilot killed.** Pit Viper may perform no further actions. Defensive Value drops to 5.
  - 3 — **Pilot dazed.** Pit Viper may not move or fire until after the end of the next game turn.
  - 4 — **Electronic Warfare knocked out.** Pit Viper may no longer jam torps. Reduce Defensive Value by 5.
  - 5 — **Maneuver Thrusters hit.** Pit Viper may no longer make Tight Turns.
  - 6 — **Shields damaged.** Reduce Defensive Value by 3.
  - 7 — **Weapons Systems hit.** Reduce chance To Hit by 1, and lose D4-1 torps.
  - 8 — **Evade Thrusters hit.** Reduce Defensive Value by 4.
  - 9 — **Engines severely damaged.** Pit Viper reduced to a Drive value of 1. Reduce Defensive Value by 7.
  - 10 — **Engines destroyed.** Pit Viper may not move or turn. Reduce Defensive Value to 5.
  - 11 — **Hull breached.** Reduce Defensive Value by 5. At the end of next game turn, Pit Viper will disintegrate and be destroyed.
  - 12 — **Reactor hit.** Power generator detonates; Pit Viper is destroyed.

**PULSE LASER SPECS**

Short Range: 1-3 hexes (+1 To Hit).  
Medium Range: 4-9 hexes.  
Long Range: 10 hexes (-1 To Hit).

## Sigurd Fleet Composition

|  |  |
|--|--|
| <p>SPACS<br/>Blizzard, Dagger, Dart, Hell Bender, Hound, Night Hawk, Pit Viper III, Spirit Rider III, Talon.</p> <p>TPACS<br/>Glaive III, Hammer, Pharsii II, Revenge, Revenge II, Sentry, Sentry II, Sorenson III, Storm, Storm II.</p> | <p>MPACS<br/>Betafortress, Drakar, Epping, Iceberg, Star Raven, Star Raven Alpha.</p> <p>Escorts<br/>Aosho, Constellation, Fletcher, Longboat, Megafortress, Narwhal II, Stingray.</p> |
|--|--|

## Starcraft Point Cost Table

| Starcraft             | Basic Point Value | Crew | Starcraft          | Basic Point Value | Crew |
|-----------------------|-------------------|------|--------------------|-------------------|------|
| Saucer Shuttle        | 6                 | 1    | Salamander         | 66                | 2    |
| Pit Viper T           | 8                 | 1    | Salamander II      | 66                | 2    |
| Pit Viper II          | 12                | 1    | Sorenson III       | 68                | 2    |
| Wind Jammer           | 13                | 1    | Avenger            | 78                | 2    |
| Pit Viper             | 17                | 1    | Epping Prime       | 78                | 4    |
| Spirit Rider II       | 17                | 1    | Sentry             | 80                | 3    |
| Blizzard II           | 18                | 1    | Sentry II          | 80                | 3    |
| Borax 1000t Frieghter | 18                | 1    | Storm              | 90                | 3    |
| Spirit Rider          | 18                | 1    | Storm II           | 100               | 3    |
| Blizzard              | 19                | 1    | Glaive III         | 104               | 2    |
| Hound                 | 19                | 1    | Glaive             | 106               | 2    |
| Dart II               | 20                | 1    | Glaive II          | 107               | 3    |
| Spirit Rider III      | 20                | 1    | Pharsii            | 110               | 4    |
| Dart                  | 21                | 1    | Epping             | 119               | 4    |
| Thunder Bird II       | 24                | 1    | Revenge            | 120               | 2    |
| Thunder Bird          | 25                | 1    | Revenge II         | 120               | 2    |
| Wave Cutter           | 25                | 1    | Pharsii II         | 120               | 3    |
| Kosmos                | 27                | 1    | Seraph             | 121               | 2    |
| Kosmos II             | 29                | 1    | Seraph II          | 121               | 2    |
| Curtis Shuttle        | 30                | 1    | Drakar             | 121               | 5    |
| Hell Bender           | 32                | 1    | Scorpion           | 122               | 4    |
| Hell Bender II        | 33                | 1    | Star Raven         | 125               | 4    |
| Talon                 | 33                | 1    | Drakar Alpha       | 125               | 5    |
| Shryak Shuttle        | 34                | 2    | Star Raven Alpha   | 128               | 4    |
| Shryak Shuttle II     | 34                | 2    | Spider             | 129               | 3    |
| Talon II              | 38                | 1    | Catastrophe        | 142               | 4    |
| Blood Hawk            | 41                | 1    | Eagle              | 170               | 5    |
| Teal Hawk             | 43                | 2    | Iceberg            | 207               | 6    |
| Dagger                | 50                | 1    | TBD Platform       | 210               | 6    |
| Night Hawk            | 47                | 1    | Conestoga          | 215               | 5    |
| Sorenson II           | 47                | 2    | Betafortress       | 216               | 5    |
| Teal Hawk II          | 47                | 2    | Betafortress Alpha | 218               | 6    |
| Night Hawk II         | 55                | 1    | Betafortress Beta  | 220               | 6    |
| Crescent              | 55                | 3    | Megafortress       | 482               | 22   |
| Death Wind            | 60                | 2    | Stingray           | 551               | 25   |
| Hammer                | 60                | 2    | Narwhal Mk. II     | 623               | 27   |
| Lance Electra         | 60                | 2    | Aosho              | 764               | 42   |
| Lance Electra II      | 60                | 2    | Constellation      | 806               | 35   |
| Havok                 | 61                | 2    | Fletcher           | 894               | 37   |
| Death Wind II         | 64                | 2    | Longboat           | 921               | 29   |

# CONSOLIDATED MASTER WEAPON TABLE

| Weapon Type                   | Base Attack Dice | To Hit Modifiers |         |           | Target Speed Restrictions | Damage       |
|-------------------------------|------------------|------------------|---------|-----------|---------------------------|--------------|
|                               |                  | Short (+1)       | Mid (0) | Long (-1) |                           |              |
| <b>Terran Weapons</b>         |                  |                  |         |           |                           |              |
| <i>Mass Driver Cannons</i>    |                  |                  |         |           |                           |              |
| <b>Minigun</b>                | 2D6+ADB          | 1-2              | 3-5     | 6-12      | None                      | Low †        |
| <b>Autocannon</b>             | 2D6+ADB          | 1-3              | 4-10    | 11-24     | Drive ≤10                 | Medium †     |
| <b>Railrepeater</b>           | 2D6+ADB          | 1-4              | 5-15    | 16-36     | Drive ≤6                  | High †       |
| <i>Laser Cannons</i>          |                  |                  |         |           |                           |              |
| <b>Pulse Laser</b>            | 2D8+ADB          | 1-3              | 4-9     | 10        | None                      | Low          |
| <b>Meld Laser</b>             | 2D8+ADB          | 1-6              | 7-18    | 19-20     | Drive ≤12                 | Medium       |
| <b>Turbo Laser</b>            | 2D8+ADB          | 1-9              | 10-25   | 26-30     | Drive ≤8                  | High         |
| <i>Blast Cannons</i>          |                  |                  |         |           |                           |              |
| <b>Splattergun</b>            | 2D6+ADB          | 1-2              | 3-6     | 7-10      | None                      | Medium       |
| <b>Blatgun</b>                | 2D6+ADB          | 1-4              | 5-10    | 11-15     | Drive ≤13                 | High         |
| <i>Disruptor Cannons</i>      |                  |                  |         |           |                           |              |
| <b>Disruptorgun</b>           | 2D8+ADB          | 1                | 2       | 3-6       | None                      | Medium §     |
| <b>Disintegrator</b>          | 2D8+ADB          | 1                | 2-3     | 4-12      | Drive ≤11                 | High §       |
| <i>Ion Cannons</i>            |                  |                  |         |           |                           |              |
| <b>Impulsegun</b>             | 2D8+ADB          | 1-3              | 4-8     | 9-10      | None                      | High         |
| <b>Ion Ram</b>                | 2D8+ADB          | 1-5              | 6-13    | 14-15     | Drive ≤15                 | All          |
| <i>Plasma Cannons</i>         |                  |                  |         |           |                           |              |
| <b>Plazgun</b>                | 2D6+ADB          | 1-2              | 3-4     | 5-10      | None                      | All ¥        |
| <b>Heavy Plazgun</b>          | 2D6+ADB          | 1-4              | 5-8     | 9-15      | Drive ≤11                 | All x 2 ¥    |
| <i>Energy Bolt Projectors</i> |                  |                  |         |           |                           |              |
| <b>Protobolt</b>              | 2D6+ADB          | 5-8              | 9-12    | 13-16     | Drive ≤14                 | s.10/m.8/l.6 |
| <i>EMP Cannons</i>            |                  |                  |         |           |                           |              |
| <b>EMP Ray</b>                | 2D8+ADB          | 1-2              | 3-4     | 5-8       | None                      | Medium/2□    |
| <b>EMP Beam</b>               | 2D8+ADB          | 1-3              | 4-6     | 7-15      | Drive ≤14                 | High/2□      |
| <i>Tachyon Conveyers</i>      |                  |                  |         |           |                           |              |
| <b>Tachyon Cannon</b>         | 2D10+ADB         | 1-5              | 6-15    | 16-19     | Drive≤14                  | High         |
| <b>Tachyon Ram</b>            | 2D10+ADB         | 1-3              | 4-11    | 12-17     | Drive≤15                  | All          |
| <i>Gaus Field Generators</i>  |                  |                  |         |           |                           |              |
| <b>Mjölmir</b>                | 2D8+6+ADB        | 1-3              | 4-7     | 8-10      |                           | Low+3        |
| <b>Gungir</b>                 | 2D8+6+ADB        | 1-5              | 6-10    | 11-16     | Drive≤13                  | Med+??+2     |
| <b>HATCHLING WEAPON</b>       |                  |                  |         |           |                           |              |
| <i>Beam Cannons</i>           |                  |                  |         |           |                           |              |
| <b>X-Beam</b>                 | 2D8+ADB          | 1-3              | 4-14    | 15-16     | None                      | Low x 3      |
| <b>Y-Beam</b>                 | 2D8+ADB          | 1-3              | 4-16    | 17-18     | Drive ≤13                 | Medium x 2   |
| <b>Z-Beam</b>                 | 2D8+ADB          | 1-3              | 4-20    | 21-22     | Drive ≤10                 | High x 2     |
| <i>Leech Cannons</i>          |                  |                  |         |           |                           |              |
| <b>Drive Leech</b>            | 2D6+ADB          | 1                | 2       | 3-4       | None                      | Low ‡        |
| <i>Launchers</i>              |                  |                  |         |           |                           |              |
| <b>Spore Mole</b>             | 1D6              | —                | 0-6*    | —         | None                      | Low Δ        |
| <i>Warheads</i>               |                  |                  |         |           |                           |              |
| <b>Type 1 Drone</b>           | 1D12             | —                | 0-1◇    | —         | None                      | All          |
| <b>Type 2 Drone</b>           | 2D12             | —                | 0-2◇    | —         | None                      | All          |
| <b>Type 3 Drone</b>           | 3D12             | —                | 0-3◇    | —         | None                      | All          |
| <b>Type 4 Drone</b>           | 4D12             | —                | 0-4◇    | —         | None                      | All          |
| <b>Type 5 Drone</b>           | 5D12             | —                | 0-5◇    | —         | None                      | All          |

## Notes

†—Whenever two of the attack dice roll doubles, multiply base damage delivered by 2.

§—If target's Defensive Value has not been reduced by a critical hit, add 1 to its Defensive Value. Also, completely ignore target's Damage Reduction when resolving a hit.

¥—If the attack dice roll triples, the weapon mount overloads and is destroyed. The target is not affected.

□—If the attack dice roll doubles or triples, the target takes an additional critical. Also, completely ignore target's Damage Reduction when resolving a hit.

\*—A missile/spore mole target must be within 10/6 hex range only at the beginning of the Missile/Spore Mole Launch Phase.

‡—Low damage is distributed only to the target's Drive damage boxes, ignoring Damage Reduction value.

Δ—Low damage indicates the number of crewman killed in the target vessel. No hits are inflicted on the Damage Track.

◇—Hits within this range are automatic; there is no need to roll To Hit.

## Integrated Escort Weapon Table

| Weapon Type                 | Short Mid Long Target Speed |      |       | Restriction | Damage     |               |
|-----------------------------|-----------------------------|------|-------|-------------|------------|---------------|
|                             | Attack Dice(+1)             | (0)  | (-1)  |             |            |               |
| <b>Ion Weapons</b>          |                             |      |       |             |            |               |
| Ion Cannon                  | 2D8                         | 1-8  | 9-16  | 17-30       | Drive ≤ 7  | All x 2       |
| Twin Ion Cannon             | 2D8+1                       |      |       |             | Drive ≤ 6  | (All+2) x 2   |
| Triple Ion Cannon           | 2D8+3                       |      |       |             | Drive ≤ 5  | (All+4) x 2   |
| Quad Ion Cannon             | 2D8+5                       |      |       |             | Drive ≤ 4  | (All+6) x 2   |
| Impulse Cannon              | 2D8                         | 1-3  | 4-5   | 6-11        | Drive ≤ 9  | High x 2      |
| Twin Impulse Cannon         | 2D8+1                       |      |       |             | Drive ≤ 8  | (High+2) x 2  |
| Triple Impulse Cannon       | 2D8+3                       |      |       |             | Drive ≤ 7  | (High+4) x 2  |
| Quad Impulse Cannon         | 2D8+5                       |      |       |             | Drive ≤ 6  | (High+6) x 2  |
| <b>Blast Weapons</b>        |                             |      |       |             |            |               |
| Blast Cannon                | 2D6                         | 1-8  | 9-20  | 21-25       | Drive ≤ 9  | Medium x 2    |
| Twin Blast Cannon           | 2D6+1                       |      |       |             | Drive ≤ 8  | (Medium+2)x2  |
| Triple Blast Cannon         | 2D6+2                       |      |       |             | Drive ≤ 7  | (Medium+4)x 2 |
| Quad Blast Cannon           | 2D6+3                       |      |       |             | Drive ≤ 6  | (Medium+6)x 2 |
| Repeating Blaster           | 2D6                         | 1-3  | 4-8   | 9-15        | None       | High x 2      |
| Twin Repeating Blaster      | 2D6+1                       |      |       |             |            | (High+2) x 2  |
| Triple Repeating Blaster    | 2D6+2                       |      |       |             |            | (High+4) x 2  |
| Quad Repeating Blaster      | 2D6+3                       |      |       |             |            | (High+6) x 2  |
| <b>Laser Weapons</b>        |                             |      |       |             |            |               |
| Laztube                     | 2D10                        | 1-10 | 11-20 | 21-40       | Drive ≤ 8  | High x 2      |
| Twin Laztube                | 2D10+2                      |      |       |             | Drive ≤ 7  | (High+1) x 2  |
| Triple Laztube              | 2D10+4                      |      |       |             | Drive ≤ 6  | (High+2) x 2  |
| Quad Laztube                | 2D10+6                      |      |       |             | Drive ≤ 5  | (High+3) x 2  |
| <b>Mass Drivers†</b>        |                             |      |       |             |            |               |
| Gatling Cannon              | 2D6                         | 1-4  | 5-8   | 9-16        | Drive ≤ 15 | Low x2=       |
| Twin Gatling Cannon         | 2D6+1                       |      |       |             | Drive ≤ 15 | (Low+1) x2=   |
| Triple Gatling Cannon       | 2D6+3                       |      |       |             | Drive ≤ 15 | (Low+2) x2=   |
| Quad Gatling Cannon         | 2D6+5                       |      |       |             | Drive ≤ 15 | (Low+3) x2=   |
| Hyper Cannon                | 2D6                         | 1-8  | 9-15  | 16-30       | Drive ≤ 11 | High x2=      |
| Twin Hyper Cannon           | 2D6+1                       |      |       |             | Drive ≤ 10 | (High+1) x2=  |
| Triple Hyper Cannon         | 2D6+3                       |      |       |             | Drive ≤ 9  | (High+2) x2=  |
| Quad Hyper Cannon           | 2D6+5                       |      |       |             | Drive ≤ 8  | (High+3) x2=  |
| Keel Cannon                 | 2D8                         | 1-10 | 11-15 | 16-20       | None       | All x 3=      |
| <b>Plazprojector</b>        |                             |      |       |             |            |               |
| Corvette                    | XD8                         |      | 1-5   |             | None       | All           |
| Frigate                     | XD10                        |      | 1-5   |             | None       | All           |
| Destroyer                   | XD12                        |      | 1-5   |             | None       | All           |
| <b>Gaus Field Generator</b> |                             |      |       |             |            |               |
| Bifrost Cannon              | 2D10                        | 1-10 | 11-20 | 21-30       |            |               |

## Deflection To Hit Modifiers Table

| Defender is in this Firing Arc of the Attacker | Attacker is in this Arc of the Defender |     |     |    |     |     | Target Has Drive 0 |
|--|---|-----|-----|----|-----|-----|--------------------|
|  | F                                       | FQL | FQR | R  | RQL | RQR |                    |
| Front  | 0                                       | -2  | -2  | +1 | 0   | 0   | +2                 |
| Front Quarter Left                             | -2                                      | -1  | +1  | +1 | -1  | +1  | +1                 |
| Front Quarter Right                            | -2                                      | +1  | -1  | +1 | +1  | -1  | +1                 |
| Rear   | +1                                      | 0   | 0   | 0  | -1  | -1  | +2                 |
| Rear Quarter Left                              | 0                                       | -1  | +1  | 0  | -1  | -1  | +1                 |
| Rear Quarter Right                             | 0                                       | +1  | -1  | 0  | -1  | -1  | +2                 |





## ALTERNATE RANGE EFFECTS TABLE

|                               | Range Increments (To Hit Modifiers) |               |               |              |                   |                 |
|-------------------------------|-------------------------------------|---------------|---------------|--------------|-------------------|-----------------|
|                               | Point Blank<br>+2                   | Short<br>(+1) | Medium<br>(0) | Long<br>(-1) | Very Long<br>(-2) | Extreme<br>(-4) |
| <b>Terran Weapons</b>         |                                     |               |               |              |                   |                 |
| <i>Mass Driver Cannons</i>    |                                     |               |               |              |                   |                 |
| <b>Minigun</b>                | 1                                   | 2             | 3-5           | 6-10         | 11-12             | —               |
| <b>Autocannon</b>             | 1                                   | 2-3           | 4-10          | 11-20        | 21-22             | 23-24           |
| <b>Railrepeater</b>           | 1                                   | 2-4           | 5-15          | 16-30        | 31-33             | 34-36           |
| <i>Laser Cannons</i>          |                                     |               |               |              |                   |                 |
| <b>Pulse Laser</b>            | 1-2                                 | 3             | 4-8           | 9            | 10                | —               |
| <b>Meld Laser</b>             | 1                                   | 2-6           | 7-15          | 16-17        | 18-19             | 20              |
| <b>Turbo Laser</b>            | 1                                   | 2-9           | 10-19         | 20-25        | 26-28             | 29-30           |
| <i>Blast Cannons</i>          |                                     |               |               |              |                   |                 |
| <b>Splattergun</b>            | 1                                   | 2             | 3-4           | 5-6          | 7-10              | —               |
| <b>Blatgun</b>                | 1                                   | 2-4           | 5-7           | 8-10         | 11-13             | 14-15           |
| <i>Disruptor Cannons</i>      |                                     |               |               |              |                   |                 |
| <b>Disruptorgun</b>           | —                                   | 1             | 2             | 3-4          | 5-6               | —               |
| <b>Disintegrator</b>          | —                                   | 1             | 2-3           | 4-6          | 7-12              | —               |
| <i>Ion Cannons</i>            |                                     |               |               |              |                   |                 |
| <b>Impulsegun</b>             | 1                                   | 2-3           | 4-6           | 7-8          | 9-10              | —               |
| <b>Ion Ram</b>                | 1                                   | 2-5           | 6-13          | 14           | 15                | —               |
| <i>Plasma Cannons</i>         |                                     |               |               |              |                   |                 |
| <b>Plazgun</b>                | 1                                   | 2             | 3-4           | 5-6          | 7-8               | 9-10            |
| <b>Heavy Plazgun</b>          | 1                                   | 2-4           | 5-8           | 9-10         | 11-12             | 13-15           |
| <i>Energy Bolt Projectors</i> |                                     |               |               |              |                   |                 |
| <b>Protobolt</b>              | —                                   | 5-8           | 9-12          | 13-16        | —                 | —               |
| <i>EMP Cannons</i>            |                                     |               |               |              |                   |                 |
| <b>EMP Ray</b>                | 1                                   | 2             | 3-4           | 5-6          | 7                 | 8               |
| <b>EMP Beam</b>               | 1                                   | 2-3           | 4-6           | 7-10         | 11-14             | 15              |
| <i>Gaus Field Generators</i>  |                                     |               |               |              |                   |                 |
| <b>Mjölmir</b>                | 1                                   | 2-3           | 4-7           | 8            | 9                 | 10              |
| <b>Gungir</b>                 | 1-2                                 | 3-5           | 6-10          | 11-13        | 14-15             | 16              |
| <i>Tachyon Conveyers</i>      |                                     |               |               |              |                   |                 |
| <b>Tacyon Ram</b>             | 1-2                                 | 3             | 4-11          | 12-13        | 14-15             | 16              |
| <b>Tachyon Cannon</b>         | 1-2                                 | 3-5           | 6-15          | 16-17        | 18                | 19              |
| <b>HATCHLING WEAPONS</b>      |                                     |               |               |              |                   |                 |
| <i>Beam Cannons</i>           |                                     |               |               |              |                   |                 |
| <b>X-Beam</b>                 | 1                                   | 2-3           | 4-14          | 15           | 16                | —               |
| <b>Y-Beam</b>                 | 1                                   | 2-3           | 4-16          | 17           | 18                | —               |
| <b>Z-Beam</b>                 | 1                                   | 2-3           | 4-20          | 21           | 22                | —               |
| <i>Leech Cannons</i>          |                                     |               |               |              |                   |                 |
| <b>Drive Leech</b>            | —                                   | 1             | 2             | 3            | 4                 | —               |

## New Weapon System Data Table

| Weapon System                  | Cost | Slots | Base Attack | Dice  | Damage   | Ammo | Crew |
|--------------------------------|------|-------|-------------|-------|----------|------|------|
| <b>EMP Cannons</b>             |      |       |             |       |          |      |      |
| EMP Ray                        | 3    | 1     |             | 2D8   | Medium   | ∞    |      |
| EMP Beam                       | 5    | 4     |             | 2D8   | High     | ∞    |      |
| <b>Tachyon Conveyers</b>       |      |       |             |       |          |      |      |
| Tachyon Cannon                 | 12   | 11    |             | 2D10  | All      |      |      |
| Tachyon Ram                    | 7    | 5     |             | 2D10  | High     |      |      |
| <b>Extended Range Missiles</b> |      |       |             |       |          |      |      |
| Hammerhead 5                   | 4    | 3     |             | 1D6/  | High+1/  | 5    |      |
| Hammerhead 10                  | 5    | 3     |             | 1D6/  | High+1/  | 10   |      |
| Hammerhead 15                  | 6    | 4     |             | 1D6/  | High+1/  | 15   |      |
| Hammerhead 20                  | 7    | 4     |             | 1D6/  | High+1/  | 20   |      |
| <b>Gaus Field Generators</b>   |      |       |             |       |          |      |      |
| Mjölmir                        | 4    | 4     |             | 2D8+6 | Low+3    | ∞    |      |
| Gungnir                        | 6    | 5     |             | 2D8+6 | Medium+2 | ∞    |      |
| Bifrost Cannon*                | 32   | 32    |             | 2D10  | Allx2    | ∞    | 5    |

\* Escort Kiel Arc's only

# Sigurd Scenarios

## Scenario I: Border Patrol

Tensions run high on the Colos/Sigurd border. Fighter patrols frequently cap off rounds against their counterparts, and often this instigates full-fledged dog fights. The carrier Yggr currently patrols the border. The 23rd Sigurd Heavy Flotilla, "Odin's Thunder," protects the Yggr. The 23rd is the Sigurds' best and strongest Warhound flotilla, and its placement indicates how high border tensions run. The 23rd, however, acts in reserve only; fighters from Yggr handle all patrolling. The Midgard 27th Support Wing "Storm of Odin" is flying with the Yggr on a two-month stint to give the pilots some carrier and combat experience.

### Forces

**Elements of the Houndslayer squadron from Fighter Wing Y-12, "Viking Vanguard." (TPV 261)**

**Commanding Officer:** Brynhild  
"Lizard-Bane" Thvarison (Glaive III)

Set up first along edge 2 within 10 hexes of each other.

|              |                              |
|--------------|------------------------------|
| Dagger A     | Pilot (Plt 7, Gnr 9, Lck 4)  |
| Dagger B     | Pilot (Plt 6, Gnr 7)         |
| Glaive III A | Pilot (Plt 10, Gnr 3, Lck 1) |
|              | Gunner A (Gnr 10)            |

**Colosian Patrol Element (TPV 223)**

Set up second along edge 4 within 12 hexes of each other.

Thunderbird A  
Thunderbird C  
Seraph A

Pilot (Plt 7, Gnr 4, Lck 3)  
Pilot (Plt 6, Gnr 9)  
Pilot (Plt 8, Gnr 5, Lck 2)  
Gunner (Gnr 8)

### Special Rules

- 1) Brynhild Thvarison hates Colosians and needs to get some combat experience for two of her rookie Dagger pilots. She's picking this fight, so the Sigurds automatically get initiative for the first turn.
- 2) Command officers on both sides frown on using up torps and missiles during these encounters, so subtract three points for each torp launched and one point for each missile launched.
- 3) Brynhild is trying to train her pilots to use their GFG to destroy multiple torps. Sigurds get an extra point for each torp destroyed via the GFG.

### Victory Conditions

These skirmishes are quick and seldom lethal; both sides attack fast and tend to break off. At the end of four turns add up the damage to both sides. Every box destroyed counts as a point. Ships destroyed via a critical hit score the full damage track. Then add or subtract special rules points as listed above. The side with the highest total wins.

# The Next Millennium

"May I offer you a chair? Something to drink, perhaps?"

"No, thank you, lord. I prefer to stand."

"Very well. That drink then?" he said as he turned his back to Brawn and walked back to his seat on the dias. "I have some wonderful brandy the Kashmere brought—my taster assures me it isn't poisoned." He smiled.

"No, thank you. I'm afraid this is not a social visit."

"Oh?" said the duke, one eyebrow raising. "Then please do tell me what is important enough for you to come to see me yourself?"

The duke's dark eyes bored into Brawn as the engineer turned warrior gathered himself for battle.



# Silent Death

Brawn stood straight, clasped his hands at the small of his back, and began his attack.

"I think perhaps this would be better spoken of in private," he said, gesturing with a nod of his head in the direction of the chamberlain and the two guards that stood just inside the chamber doors. The duke waved his hand, a dismissal. Brawn heard the doors open and close behind him.

"Very well, Sir Brawn. We are now alone."

"The recording devices as well, lord Serevino." Brawn saw the skin tighten around the duke's eyes, the only indication that the duke

## Scenario 2: Pilot Retaliation

Pirates attacked and destroyed a Sigurd freighter convoy near New Denmark space. The freighters carried tech supplies from Agomio vital to New Denmark's rebuilding process. Sigurd command suspects Kashmere influence and wants the pirates eliminated before they can flee. Unfortunately for the pirates, a 14th Defense Wing patrol is in intercept range; the pirates will have to fight their way out. Use the long map setup as illustrated in *SD:TNM* p. 227.

### Forces

#### Elements of Odin's Enforcers squadron of the 14th Defense Wing "Beastlayer." (TPV 201)

**Commanding Officer:** Lisa Essech (Hound A)

Set up first anywhere between edge 1 and middle of map.

|                    |  |
|--------------------|--|
| Hound A            | Pilot (Plt 7, Gnr 5)                     |
| Hound B            | Pilot (Plt 8, Gnr 5)                     |
| Hound C            | Pilot (Plt 5, Gnr 4)                     |
| Spirit Rider III A | Pilot (Plt 5, Gnr 5)                     |
| Spirit Rider III B | Pilot (Plt 3, Gnr 3)                     |
| Hammer A           | Pilot (Plt 6, Gnr 6)<br>Gunner A (Gnr 7) |

#### Unknown Pirate Element (TPV 213)

Set up along edge 3 within 12 hexes of each other.

|              |                             |
|--------------|-----------------------------|
| Hellbender A | Pilot (Plt 8, Gnr 5, Lck 1) |
| Hellbender B | Pilot (Plt 4, Gnr 6, Lck 1) |
| Nighthawk A  | Pilot (Plt 7, Gnr 7, Lck 3) |
| Nighthawk B  | Pilot (Plt 4, Gnr 5, Lck 4) |

### Special rules

- 1) The Hell Benders used up their torps on the Freighter convoy so they have no Mk.30s for this fight.
- 2) Lisa Essech (Hound A) is the squadron leader, but has no kills to her name. She must remain pilot of a Hound until she has at least one kill. She is desperate to earn a kill and move up to one of the Hammers in her squad. If she gets at least half the damage points on a pirate ship that's destroyed or disabled, add 50 points to the Sigurd total.
- 3) Sigurd reinforcements are on the way. The pirates have only six turns to get off the map before more Sigurd ships arrive. Pirates must exit from edge 1.

### Victory Conditions

After six turns, add up the TPV of all pirate ships that exited from the board; this is the pirate player's score. The Sigurd player adds up the TPV of all ships either destroyed or still on the board at the end of six turns. The player with the highest total wins.



# Scenario 3: Newts for Breakfast

The Hibernian Intelligence Agency (HIA) earns some of its annual budget by selling the Sigurd military information. This time the HIA uncovered a gem: a Draconian training flight in Colosian space. Several rookie Draconian pilots are flying out to engage Colosian fighters in a training exercise. The Sigurds plan to infiltrate Colosian space, intercept this flight, destroy as many ships as possible, then head back to the border and the safety of the Yggr. As the saying goes, the only good Draconian is a skinned Draconian.

The 27th Support wing earned the right to fly this mission. Herthjof “The Bleeder” Byati and elements of his Bloodwing squadron will fly at full burn, punch through a hole in Colosian border sensors, close with the Draconians, fight for five turns and then bail, again at full burn. The target zone is well inside the border, and the Bloodwing fighters have only enough time for a short skirmish if they are to reach safety before reinforcements arrive. Use the standard map setup as shown in *SD:TNM* p. 103.

## Forces

### Elements of Bloodwing squadron from the 27th Support Wing “Storm of Odin.” (TPV 340)

**Commanding Officer:** Herthjof “The Bleeder” Byati (Glaive III A)

Set up first along edge 1.

|              |  |
|--------------|--|
| Hound A      | Pilot (Plt 6, Gnr 4, Lck 2)              |
| Hound B      | Pilot (Plt 5, Gnr 5)                     |
| Hammer A     | Pilot (Plt 6, Gnr 7)<br>Gunner (Gnr 5)   |
| Hammer B     | Pilot (Plt 5, Gnr 4)<br>Gunner (Gnr 6)   |
| Glaive III A | Pilot (Plt 8, Gnr 8)<br>Gunner A (Gnr 7) |

### Training Flight of 7004th Draconian SMAC Regiment “Firebreathers”

(TPV 310)

**Commanding Officer:** Prangut (Seraph A)

Set up second in section C or D.

|             |  |
|-------------|--|
| Pit Viper A | Pilot (Plt 2, Gnr 3)                     |
| Pit Viper B | Pilot (Plt 3, Gnr 3)                     |
| Pit Viper C | Pilot (Plt 2, Gnr 3)                     |
| Pit Viper D | Pilot (Plt 5, Gnr 2)                     |
| Pit Viper E | Pilot (Plt 4, Gnr 5)                     |
| Pit Viper F | Pilot (Plt 6, Gnr 4)                     |
| Pit Viper G | Pilot (Plt 2, Gnr 1)                     |
| Pit Viper H | Pilot (Plt 2, Gnr 3)                     |
| Pit Viper I | Pilot (Plt 2, Gnr 2)                     |
| Seraph A    | Pilot (Plt 8, Gnr 9)<br>Gunner A (Gnr 7) |

## Special Rules

- 1) The Sigurd fighters only have enough time to stay on the board for seven turns. Any ships still on the board at that time will run into reinforcements before they reach the border. Consider any Sigurd ship still on the board at the end of the sixth turn destroyed and add its TPV to the Draconian victory total.
- 2) The Draconian pilots are rookies. Confusion reigns as the Sigurd fighters come screaming in from out of nowhere. Reinforcements are already on the way. Prangut desperately wants to avoid panic in his rookies: if they scatter, some of them may head in the wrong direction and the coordinated Sigurds can pick them off one by one. Prangut orders them to stay together. As such, the Draconian ships can't leave the board.
- 3) The attack catches the Draconian flight by surprise, so the first turn's initiative automatically goes to the Sigurds.
- 4) Sigurds must leave via edge 1.
- 5) Since the Draconians only want to survive this attack, they get an extra 10 points for each ship that survives the encounter and is still capable of flying off the board.

## Victory Conditions

At the end of seven turns total up the TPV of all enemy fighters destroyed. The side with the highest total wins.

# The Next Millennium

found this revelation even remotely surprising. *He's as controlled as Guttman said he is*, Brawn thought. *Truly, it's no surprise he has recording devices installed; most every lord of every house has something of the sort installed in their audience and meeting chambers. Others—like Duke Serevino, I suspect—have them installed in their guest quarters as well.*

“This is quite irregular, Sir Brawn,” he said, fingering a small console underneath the right arm of his chair, his eyes never leaving Brawn's. “But it is now as you wish. We are quite alone.

“Now. Pray tell me what is so important and so secret a matter that you come all this way, and make all these demands.”

“Truthfully, lord, it is a matter of great import to you.” No change in the duke's expression.



# Silent Death

“I have come into the possession of certain information,” Brawn continued, “which implicates you in a number of illegal activities. Now, while this in itself may not likely be of much concern to you, the sheer magnitude of the illegal activities listed, and the extent to which they... relate...to our beloved Emperor, if you take my meaning, may prove...rather inconvenient for you if this information were ever to be released.”

The duke sat unmoving on the dias, staring at Brawn. He lifted one hand and ran it through his hair. *Excellent*, thought Brawn, recognizing the sign of discomfort just as Guttman had taught him. *I've got him on the defensive now.*



## Scenario 4: Done with Mirrors

The Sigurd attack on the Draconian training flight draws the attention of Colosian patrols. As these patrols move toward the conflict area to probe for further Sigurd encroachment, the real reason for the attack becomes clear.

Using the training-flight raid as a diversion, elements from the 201st Missionaries of Death rush to attack a Draconian communications platform. The platform houses a Tachyon Beam Dictor (TBD), which provides the Lizards with solid, reliable communication throughout Colosian and

Sigurd space and well into the Backnet. Such a construction is an affront to the Archdiocese. Several highly respected, devout followers of Odin volunteered to take the platform out: they know many of them won't be coming back.

Sigurd pilots are out to destroy anything and everything in their path. The Draconian player, on the other hand, must completely shut down the speedy Missionaries before they reach the platform. Draconians enjoy a clear firepower advantage, while Sigurds have the edge in speed and numbers.

### Battle 1

**Date:** AL 12:142

Gunner A (Gnr 5)

**Location:** Open sector of Sigurd/Colosian border

**Elements of Beta Squadron of the “Dangerous Drakes” fighter wing (TPV 438)**

**Situation:** Sigurd ships have raced through the border on a bee-line for the communications platform. The Draconian command underestimated the range of Sigurd fighters, which launched from an unregistered freighter very close to the border. All Draconian patrols from the 7001st TPAC wing rush forward to slow the attack as the main body of Draconian fighters scrambles to reach the platform in time. Use the long map setup as shown in SD:TNM p. 103.

**Squadron Leader:**

M'chaka Kam Linzo (Pharsii II A)

Set up anywhere in sections E, F, G or H.

|              |   |
|--------------|---|
| Pharsii II A | Pilot (Plt 9, Gnr 7, Lck 3)<br>Gunner A (Gnr 6)<br>Gunner B (Gnr 5) |
| Pharsii II B | Pilot (Plt 6, Gnr 4, Lck 1)<br>Gunner A (Gnr 7)<br>Gunner B (Gnr 8) |
| Pharsii II C | Pilot (Plt 6, Gnr 3, Lck 2)<br>Gunner A (Gnr 5)<br>Gunner B (Gnr 6) |

### Forces

**Squad 3 of the Sigurd Rotating 201st “Missionaries of Death” (TPV 441)**

**Squad Leader:**

Rolf Ivarson (Spirit Rider III C)

Set up first along edge 1.

|                    |   |
|--------------------|---|
| Pit Viper II A     | Pilot (Plt 7, Gnr 5, Lck 4)                     |
| Pit Viper II B     | Pilot (Plt 6, Gnr 6, Lck 1)                     |
| Pit Viper II C     | Pilot (Plt 4, Gnr 3)                            |
| Spirit Rider III A | Pilot (Plt 7, Gnr 9, Lck 5)                     |
| Spirit Rider III B | Pilot (Plt 5, Gnr 5)                            |
| Spirit Rider III C | Pilot (Plt 4, Gnr 10)                           |
| Hammer A           | Pilot (Plt 9, Gnr 4, Lck 3)<br>Gunner A (Gnr 5) |
| Hammer B           | Pilot (Plt 10, Gnr 3)<br>Gunner A (Gnr 7)       |
| Sorenson A         | Pilot (Plt 6, Gnr 8, Lck 1)                     |

### Special Rules

- 1) The Sigurds would like to spend as little time as possible with the forward Pharsii element. Their goal is to use speed to blow by the Pharsiis and continue with the mission. The Sigurd player needs to get his ships off edge 3 as fast as possible. Consider lost any Sigurd ship left on the board at the end of six turns, wiped out by late-coming Colosian reinforcements.
- 2) Speed is of the essence, so for every Spirit Rider III and Pit Viper II that makes it off the board, add 10 points to the Sigurd win total.
- 3) The Draconians are scrambling to deal with this threat, and know that time is

Brawn pressed his attack. “Now, these same sources of information have also revealed the extent of the assets these illegal activities have garnered you. If you were to generously *donate* some of those assets, these sources of information need never reach the Emperor.”

Brawn stared at the duke, showing as grim a face as he could muster.

The duke was silent for what seemed ages to Brawn. Finally he smiled, and spoke.

“Ah, so it’s blackmail, is it? I would think that a pet of the Emperor such as yourself would have more wealth at his disposal than he could ever need. But that of course assumes that this wealth is for you, which we both know it is not.”



their biggest enemy. The Pharsiis have to slow the Sigurds down long enough for a defensive force to reach the station. With this in mind, the Draconians know they need to hit the Sigurd’s fastest ships. Add 10 points to the Draconian victory total for each Spirit Rider III and Pit Viper II destroyed or left on the board at the end of the sixth turn.

- 4) Rolf Ivarson is one kill away from Magni status (the Sigurd’s “Ace” designation for five kills), and would love to reach that goal on this dangerous and prestigious mission. Add three points to the Sigurd total if he gets a kill, even if he winds up dead at scenario’s end.
- 5) In the missile results phase, resolve normally all missiles following ships that leave the map. You can’t escape them by running off the board. Once you are off the board, however, you may no longer be targeted by an attack of any kind.
- 6) Torpedoes following a ship off the board can still strike their target if the torps are faster than that target. Remove any torps slower than the ship it is tracking when that ship leaves the

map. If the torpedo is faster, however, use the following order.

- A) If the ship has a rear arc, allow an immediate shot on the torpedo at point-blank range. This simulates the lack of enemy ships: the pilot can fly straight and the gunner has plenty of time to concentrate on a shot.
- B) If that shot does not destroy the torp, move immediately to Torpedo Results Phase. Add +2 to any dodging attempts: again to simulate the pilot’s ability to concentrate solely on that action.
- C) If multiple sets of torps follow the ship off the board, resolve each set independently using steps A & B above. A “set” is a group of torpedoes moving together at the same speed, so that they would reach the vessel simultaneously.

## Victory Conditions

The entire sortie hinges on the success or failure of the fast ships, hence the bonus for their final position. Add up the bonuses and the TPV of all ships destroyed. The side with the highest total wins. Any victory is, of course, irrelevant: you will determine the true winner in the next scenario.

## Battle 2

**Situation:** Any Sigurd ship that made it off the board in Battle one is available for battle two, the assault on the platform. These ships remain unchanged from the previous battle—any damage taken is still in effect unless damage control repaired the hits. The Sigurd player may attempt a maximum of three damage control attempts before Scenario 2 takes place. In addition to those ships, the Sigurd command plays its trump card: the FTL ability of the Storm.

Four Storms break out of hyperspace to reinforce the light fighters at the point of attack. Draconian and Colosian defenders saw the Storms coming, but the ships travel so fast over a short distance reaction time was nil.

Due to the speed of the assault, the Draconians couldn’t bring their full force to bear. Reinforcements will arrive quickly, but may be too late. More patrol

elements from the Deadly Drakes are all the Draconians could muster in time.

Use the standard map setup as shown in *SD:TNM* p. 103.

## Forces:

### Elements from Squad 3 of the 201st “Missionaries of Death” (TPV 437)

#### Squad Leader: Svanhit

“Hull-Splitter” Aesa (Storm A)

Set up first along edge 1.

|         |   |
|---------|---|
| Storm A | Pilot (Plt 5, Gnr 3, Lck 2)<br>Gunner A (Gnr 5)<br>Gunner A (Gnr 5) |
| Storm B | Pilot (Plt 8, Gnr 3, Lck 2)<br>Gunner A (Gnr 6)<br>Gunner A (Gnr 3) |
| Storm C | Pilot (Plt 5, Gnr 3, Lck 1)<br>Gunner A (Gnr 5)<br>Gunner A (Gnr 4) |
| Storm D | Pilot (Plt 6, Gnr 3)<br>Gunner A (Gnr 4)<br>Gunner A (Gnr 4)        |

# Silent Death

“So why don’t you just tell me what Guttman wants?”

This caught Brawn by surprise; he tried not to let it show on his face, but he knew that the duke’s barb had struck. Guttman had told him to expect anything of Serevino, but Brawn hadn’t expected Serevino to know of his connection with the Church of Odin; even the Emperor didn’t know that.

But he pressed on against the duke—he couldn’t back out now. “In exchange for the information we have never reaching the Emperor’s hands, you will donate to the Church of Odin half of those illegal assets, in the form of several refurbished passenger liners you will purchase from the Icarus Corporation. You will present these ships to



## Elements from Alpha Squadron of the “Dangerous Drakes” fighter wing (TPV 668).

**Squadron Leader:** Lorrenso Oskar (Seraph A)

Set up second in areas E, F, G, or H.

|          |  |
|----------|--|
| Seraph A | Pilot (Plt 8, Gnr 7, Lck 3)<br>Gunner A (Gnr 6)                              |
| Seraph B | Pilot (Plt 6, Gnr 4, Lck 1)<br>Gunner A (Gnr 9)                              |
| Seraph C | Pilot (Plt 5, Gnr 5, Lck)<br>Gunner A (Gnr 5)                                |
| Platform | Gunner A (Gnr 3)<br>Gunner B (Gnr 5)<br>Gunner C (Gnr 7)<br>Gunner D (Gnr 4) |

## Special Rules

- 1) Storms can only use FTL drives to return home, not to zip around the board at will. Sigurds can escape by leaving edge 3.

# Scenario 5: The Luck of the Hibernians

Two traits define the Sigurd military mentality: never turn down a fight and always aid your allies, no matter what the cost. As such, it’s little surprise that an outnumbered Hibernian force finds sudden reinforcements from a long-range Sigurd patrol.

The Hibernian Intelligence Agency modified a Star Raven as a long-range spy ship, capable of picking enemy communications from an incredible distance. Unfortunately for the HIA, the Data Sphere detected the spy ships and they doesn’t like to be spied on.

A modest compliment of two Lance Electras protects the stripped-down Raven. The three ships are no match for DataSphere craft from the Fc22c: Pacifica fighter wing. When the HIA fighters detected the DataSphere’s seven ships on a direct intercept course, they put out an immediate mayday. Midgard 99th patrols from the carrier Ymir immediately responded to the call for help.

Use the standard map setup as shown in *SD:TNM* p. 103.

- 2) This is a good-old fashioned slugfest: the Colosian cavalry won’t arrive for a full ten turns. If anything is left standing at that time, consider any Sigurd ship still on the board destroyed or captured.

- 3) The armed communications platform plays like an immobile gunboat. It may only turn a single hex facing per turn.

## Victory Conditions

No fancy point total here, the only victory is a tactical one. The Sigurds win if they destroyed the platform. If they fail, the Draconians win.

## Forces

### HIA spy patrol (TPV 276)

#### Squad Leader:

Shaunus Callahan (Star Raven)

Set up first within five hexes of the center of the board.

|                 |   |
|-----------------|---|
| Lance Electra A | Pilot (Plt 6, Gnr 5, Lck 1)<br>Gunner A (Gnr 3)   |
| Lance Electra B | Pilot (Plt 4, Gnr 3)<br>Gunner A (Gnr 7)  |
| Star Raven      | Pilot (Plt 6, Gnr 4, Lck 4)<br>Gunner A (Gnr 1)<br>Gunner B (Gnr 3)<br>Gunner C (Gnr 4) |

### Elements from Squad 22v3.2 of Fc22c Pacifica fighter wing (TPV 487)

Salamanders using pilot program  
Sal v12.6.2b3

Set up second in sections G and/or H.

|              |  |
|--------------|--|
| Salamander A | Pilot (Plt 7, Gnr 7)<br>Gunner (Gnr 7) |
| Salamander B | Pilot (Plt 7, Gnr 7)<br>Gunner (Gnr 7) |
| Salamander C | Pilot (Plt 7, Gnr 7)<br>Gunner (Gnr 7) |
| Salamander D | Pilot (Plt 7, Gnr 7)<br>Gunner (Gnr 7) |

**Elements from the Dominatrixies  
squadron of the Midgard 99th  
“Frigid Witches” (TPV 195)**

Squad Leader:

Carlitta Hedin (NightHawk)

Enter on edge 1 on Turn 2.

|             |                             |
|-------------|-----------------------------|
| Hound A     | Pilot (Plt 7, Gnr 8, Lck 3) |
| Hound B     | Pilot (Plt 5, Gnr 5)        |
| Hound C     | Pilot (Plt 8, Gnr 4)        |
| Hound C     | Pilot (Plt 4, Gnr 4)        |
| NightHawk A | Pilot (Plt 10, Gnr 7, Lck   |

7)

**Elements from Squad 22v3.2 of Fc22c  
Pacifica fighter wing (TPV 348)**

Revenge using pilot program Rev v5.0

Enter on edge 3

|           |  |
|-----------|--|
| Revenge A | Pilot (Plt 6, Gnr 6)<br>Gunner (Gnr 7) |
|-----------|--|

**Special Rules**

- 1) The Hibernians stripped down the Star Raven. Engineers removed much of its weaponry to make room for sensitive surveillance equipment. Engineers removed all front-mounted Meld Lasers as well as the Mk. 50s and the pilot's Pulse Lasers (mark these off on the Star Raven's display). As a result, the Raven's BP is only 103. Additionally, the gunners are technicians and their combat skill is weak—in essence the Raven is a sitting duck.
- 2) The DataSphere pilot-programs wish to incapacitate the HIA ships and capture the crews. Add +10 for each live HIA crew member still on the board at the end of the scenario.
- 3) DataSphere tech-programs would love to examine the modified Star Raven. Add +50 to the DataSphere total if the Star Raven didn't leave edge 1 by the end of the scenario.
- 4) DataSphere pilot-programs didn't expect Sigurd involvement. As a result, they consider any Sigurd offensive action a direct attack on the DataSphere. Pilot-programs will try to warn Sigurd vessels away. DataSphere pilot-programs will not fire at the Sigurds unless fired upon. Once the Sigurds shoot, however, all pilot-programs will consider the Sigurds a hostile enemy and will attack full-force.
- 5) At any time the Sigurd player can announce he is breaking off the attack, at which point the DataSphere will stop firing. Sigurd ships may leave untouched after they make this announcement. The Sigurd player may decide to do this if the Hibernian ships are destroyed and the crews killed. The Sigurd player may not make this declaration and then attack: that would bring dishonor on the Archdiocese.
- 6) The Sigurd/Hibernian goal is to escort the Star Raven off of edge one by the end of the seventh turn.
- 7) The DataSphere holds the Revenge in reserve, letting it fight only if the Star Raven threatens to avoid capture (the DataSphere will destroy it before letting it escape). How the Revenge is used against the unexpected arrival of the Sigurds is up to the DataSphere player. On turn 3 the DataSphere player may enter the Revenge from edge 1.
- 8) The Sigurd ships arrive after the DataSphere ships engage. The Sigurd player may enter his ships from edge 1 on turn two, with the first hex of the map counting as one forward movement point.

# The Next Millennium

the Church, and allow Guttman and his followers safe passage to Midgard.”

“Tell me, Sir Brawn, why I should do any such thing? Tell me why I should not simply call my guards, and order them to shoot you and dump your body into space? Perhaps because you have made some contingency plans? A transmission of you own, perhaps? One that, if you do not live to rescind the send order, will find its way to the Emperor's personal channel. A transmission describing my guilt in this other matter we have been discussing, as well as in your untimely death?”

“Effective. I should have expected as much from Guttman. What I unfortunately didn't expect was that

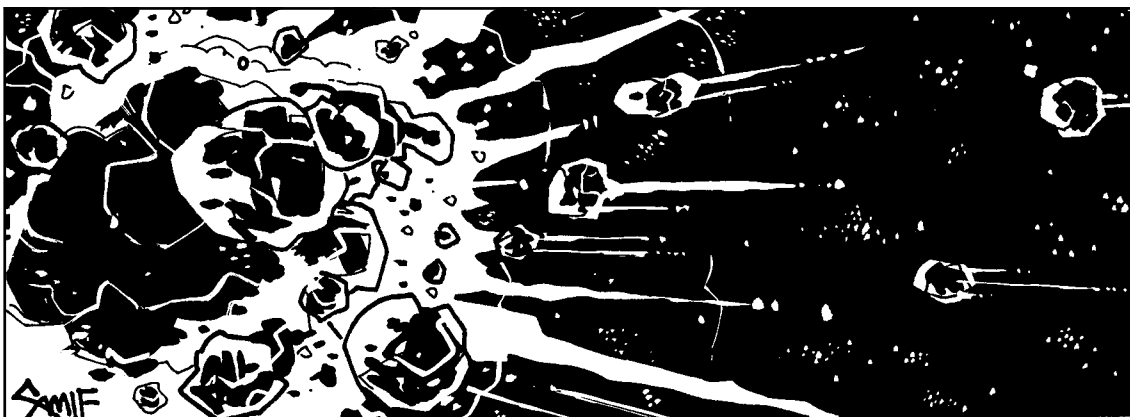



# Silent Death

he and his damnable religion could convert the prized pup of our dear Emperor.

“Well,” the duke said, waving his hand, a show of resignation. “Guttman certainly played this round effectively. Please give him my *regards* the next time you see him.”

Brawn stood still, his mind racing to follow the meaning of the duke’s words.

“You are dismissed, little Charles Brawn. You may return to Guttman with your news. I will see that the ships are purchased, refitted, and delivered to the Church of Odin. I will expect those records turned over to my representatives at the time of the ships’ delivery.”



## Scenario 6: Patchwork

“Why wasn’t this detected before,” Hans Bjorn demanded of his science officer.

“Sir, because it simply wasn’t there,” Kia Petrovics answered, unaffected as always by Bjorn’s overbearing manner. “We saw the collision coming years ago, but it wasn’t a high priority.”

“And no one ever examined that planetoid before?”

“Of course we examined it, sir, just not very thoroughly,” Petrovics replied, pushing a lock of her carefully styled blonde hair away from her face. She knew Bjorn’s warrior mind didn’t grasp the complexity of the situation. Petrovics needed to start over, explain it in simpler terms.

“The planetoid was a dead rock, for starters,” she said with a respectful smile. While she knew how to push Bjorn’s buttons, now wasn’t the time. “It completely cooled eons ago, no tectonic activity at all. Almost 500 miles of crust covered the core. With no activity we couldn’t tell what was in there. The crust is worthless rock. No one gave it a second thought. It was so worthless no one even bothered naming it.”

“Until the collision,” Bjorn said over his practiced scowl.

“Right,” Petrovics continued, “until the collision. The last orbit of the Haas-Greebold cluster caused a lot of kinetic release, generating several smaller asteroid belts, which we call ‘patches.’ These patches have their own orbits. One of these patches demolished the planetoid. Really smashed it up bad. The forces involved are incomprehensible. Imagine taking all the Sigurd warheads and multiplying them by ...”

“Just give me the important parts,” Bjorn interrupted. “I’ll listen to physics analogies later.”

“Right,” Petrovics said. “The important parts. Well, as you already know, the patch destroyed the planetoid, cracked it

like an egg into about half a million significant pieces. The impact signature tells us that inside that rock crust there is some serious ore.”

“And that’s where the Andrium is.”

“Andrium and a dozen other prime ores,” Petrovics said.

“So how is this a problem?” Bjorn asked.

“Well, the collision had enough force to drive the planetoid’s remnants out of its normal orbit,” Petrovics explained. “That momentum is taking the belt out of Sigurd space as we speak, on a tangent with the border.” Bjorn’s scowl faded away in place of a frown and a sigh. This meant trouble. Major trouble.

“The Colosian border?” he asked quietly.

“That’s right.”

“And what are the chances they don’t know about the ore that’s in that belt?”

“The chances are zero,” Petrovics replied with a stolid face. “It’s incredibly rare to witness a collision on this scale. It’s happened only once in the past 3500 years. No one alive has ever seen a planet completely destroyed. Everyone wanted data on the impact; for weapons research, I’m sure. This was the most anticipated astronomical phenomenon of the decade. Scientists all over the galaxy either watched it, picked up the impact signature or are waiting for the signature to reach them. The Colosians know exactly what’s there.”

Bjorn sighed again and gazed at the floor. Petrovics realized it was the first non-practiced emotion she’d ever seen him convey. She knew why; The Sigurd government wouldn’t allow such a treasure to simply float away. Especially into Colosian space. The situation assured conflict. Significant conflict, based on the value of the prize at hand. She realized the question that floated in her captain’s mind; could this be the event that finally triggers an all-out Sigurd-Colosian war?

## Battle 1

Use the standard map setup as shown in *SD:TNM* p. 103.

**Date:** AL12:210

**Location:** Inside Sigurd/Colosian border's disputed area

**Situation:** The Sigurds are racing to establish a beachhead in the disputed belt. They need to set up a mining facility within the belt—an established facility adds credence to Sigurd claims even as the belt drifts into Colosian space. The Colosians know such a facility could interfere their sole rights to the resources in the belt. Stopping the Sigurds cold is the only way to preserve Colosian interests. In this scenario, Sigurd fighters try to hold a tactical area against a Colosian sortie.

### Forces

**Elements from Bach's Symphony squadron of Sigurd fighter wing T-01 "Thor's Hammer." (TPV: 407)**

#### Squad leader:

Marcus Endeavor (Storm II A)

Set up first anywhere between edge 3 and the middle of the map.

|            |  |
|------------|--|
| Hound A    | Pilot (Plt 5, Gnr 5)                           |
| Hound B    | Pilot (Plt 7, Gnr 6)                           |
| Hound C    | Pilot (Plt 4, Gnr 8)                           |
| Hammer B   | Pilot (Plt 10, Gnr 6, Lck 4)<br>Gunner (Gnr 6) |
| Hammer C   | Pilot (Plt 7, Gnr 9, Lck 2)<br>Gunner (Gnr 10) |
| Storm II A | Pilot (Plt 7, Gnr 10, Lck 7)                   |

Gunner A (Gnr 7)  
Gunner B (Gnr 10)

**Elements from Squad One of Colosian 113th heavy assault wing "Death's Door." (TPV: 426)**

**Squad Leader:** Michael Wright (Pharsii A)

Set up second within 5 hexes of edge 1.

|              |   |
|--------------|---|
| Pharsii II A | Pilot (Plt 6, Gnr 7, Lck 2)<br>Gunner A (Gnr 6)<br>Gunner B (Gnr 4) |
| Pharsii II B | Pilot (Plt 6, Gnr 5)<br>Gunner A (Gnr 5)<br>Gunner B (Gnr 5)        |
| Pharsii II C | Pilot (Plt 6, Gnr 5)<br>Gunner A (Gnr 5)<br>Gunner B (Gnr 4)        |

### Special Rules

- Place 20 asteroid counters randomly between the center of the board and edge 3. The asteroids drift towards edge 2. When an asteroid leaves edge 2, it re-enters along the same line on edge 4.
- At the end of 10 turns Sigurd reinforcements arrive. Any Colosian ship left on the board is lost.
- The Colosian goal is to inflict as much damage as possible. Colosians earn +10 points for each Sigurd ship destroyed in addition to the BPV.

### Victory Conditions:

Add up the TPV of all ships destroyed and add points from the rules listed above. The highest total wins.

## Battle 2

Use the standard map setup as shown in *SD:TNM* p. 103.

**Date:** AL12:213

**Location:** Inside Sigurd/Colosian border's disputed area

**Situation:** The Sigurds managed to outmaneuver the Colosians, move the mining facility into place and repel an initial light assault. The Colosians, however, inflicted severe damage to the facility. The Sigurds need to repair it immediately to make the most of their brief victory. Squads two and three from "Death's Door" clash with the rest of Thor's Hammer.

### Forces

**Elements of Guttman's Will squadron from Sigurd fighter wing T-01 "Thor's Hammer." (TPV: 891)**

**Squad leader:** Olaf Miller (Iceberg)

Set up first on edge 3.

|          |   |
|----------|---|
| Dagger A | Pilot (Plt 8, Gnr 7, Lck 2)   |
| Dagger B | Pilot (Plt 9, Gnr 8, Lck 1)   |
| Dagger C | Pilot (Plt 7, Gnr 6, Lck 3)   |
| Dagger D | Pilot (Plt 6, Gnr 8)  |
| Dagger E | Pilot (Plt 5, Gnr 9)  |
| Storm A  | Pilot (Plt 8, Gnr 8, Lck 3)<br>Gunner A (Gnr 8)<br>Gunner B (Gnr 6) |

# The Next Millennium

The duke was silent then, and turned his face away from Brawn. Brawn turned on his heel and walked toward the exit.

As he reached for the doors, the duke's voice stopped him.

"Oh, and one more thing, Charles Brawn. Please tell Guttman if I ever see him again, anywhere near this sector, I will kill him myself.

"And the same goes for you, pawn of Odin."

Brawn stepped from the chamber into the hall, and hurried toward his transport. He had survived the battle; Odin had



# Silent Death

watched over him. And now High Priest Guttman and the Church would have their ships, and could soon make their way to their new home on Midgard.

And he, Charles Brawn, newly tested disciple of Odin, would join them on that grand homecoming. Just a year from now he would leave the service of the Emperor for good, and pledge his life and talents in the service of the true power of the Universe.

*Praise to you, All-Father, he prayed. We have won!*



|           |   |
|-----------|---|
| Storm B   | Pilot (Plt 9, Gnr 10, Lck 2)<br>Gunner A (Gnr 9)<br>Gunner B (Gnr 7)  |
| Iceberg A | Pilot (Plt 10, Gnr 8, Lck 3)<br>Gunner A (Gnr 8)<br>Gunner B (Gnr 7)<br>Gunner C (Gnr 9)<br>Gunner D (Gnr 10)<br>Gunner E (Gnr 5) |

## Colosian 113th heavy assault wing "Death's Door," Squad two (TPV: 881)

**Squad Leader:** Chris Otto (Seraph B)

Set up second on edge 1.

|            |   |
|------------|---|
| Blizzard A | Pilot (Plt 6, Gnr 4)                          |
| Blizzard B | Pilot (Plt 6, Gnr 5)                          |
| Blizzard C | Pilot (Plt 3, Gnr 6)                          |
| Glaive A   | Pilot (Plt 5, Gnr 8, Lck 2)<br>Gunner (Gnr 8) |
| Glaive B   | Pilot (Plt 6, Gnr 4, Lck 1)<br>Gunner (Gnr 4) |
| Glaive C   | Pilot (Plt 7, Gnr 6)<br>Gunner (Gnr 6)        |
| Seraph A   | Pilot (Plt 4, Gnr 5)<br>Gunner (Gnr 5)        |
| Seraph B   | Pilot (Plt 8, Gnr 7, Lck 2)<br>Gunner (Gnr 7) |
| Seraph C   | Pilot (Plt 6, Gnr 3)<br>Gunner (Gnr 9)        |

## SIGURD FREIGHTERS AND ESCORT

### Elements of Odin's Anvil squadron from Sigurd T-01 "Thor's Hammer." (TPV: 697)

**Squad leader:** Hjorolf Oddson (Hammer A)

Start on edge 3.

Enter on turn 5.

|                   |   |
|-------------------|---|
| Hound A           | Pilot (Plt 9, Gnr 6, Lck 3)                     |
| Hound B           | Pilot (Plt 8, Gnr 7, Lck 1)                     |
| Hound C           | Pilot (Plt 6, Gnr 8)                            |
| Hound D           | Pilot (Plt 8, Gnr 5)                            |
| Hound E           | Pilot (Plt 7, Gnr 6)                            |
| Hound F           | Pilot (Plt 6, Gnr 10, Lck 2)                    |
| 4)                |   |
| Hound G           | Pilot (Plt 8, Gnr 8)                            |
| Hound H           | Pilot (Plt 7, Gnr 6, Lck 2)                     |
| Hammer A          | Pilot (Plt 10, Gnr 10, Lck 2)<br>Gunner (Gnr 8) |
| 3)                |   |
| Hammer B          | Pilot (Plt 8, Gnr 7, Lck 2)<br>Gunner (Gnr 9)   |
| Hammer C          | Pilot (Plt 8, Gnr 7, Lck 2)<br>Gunner (Gnr 9)   |
| Hammer D          | Pilot (Plt 6, Gnr 5)<br>Gunner (Gnr 6)          |
| Borax Freighter A | Pilot (Plt 5)                                   |
| Borax Freighter B | Pilot (Plt 5)                                   |
| Borax Freighter C | Pilot (Plt 5)                                   |
| Borax Freighter D | Pilot (Plt 5)                                   |

## COLOSIAN REINFORCEMENTS

### Colosian 113th heavy assault wing "Death's Door," Squad three (TPV: 693)

**Squad Leader:** Phalanx Rusitti (Seraph A)

Start on edge 1

Enter on turn 7

|           |  |
|-----------|--|
| Seraph A  | Pilot (Plt 6, Gnr 5, Lck 2)<br>Gunner (Gnr 4)  |
| Seraph B  | Pilot (Plt 4, Gnr 4)<br>Gunner (Gnr 6)   |
| Revenge A | Pilot (Plt 4, Gnr 5)<br>Gunner (Gnr 8)   |
| Revenge B | Pilot (Plt 6, Gnr 3)<br>Gunner (Gnr 5)   |
| Drakkar   | Pilot (Plt 6, Gnr 3)<br>Gunner A (Gnr 6)<br>Gunner B (Gnr 7)<br>Gunner C (Gnr 4)<br>Gunner D (Gnr 2) |

## Special Rules

- 1) Asteroids blanket the area. Spread 40 counters randomly over the map, and roll randomly for the direction of drift.
- 2) This area of the belt is very active. The asteroids drift two hexes at the end of every turn.
- 3) The Colosians' mission is simply to destroy the Freighters. Add +50 to the Colosian victory total for each freighter destroyed.
- 4) Sigurd Freighters leave the board via edge 1 by the end of the 17th turn. More Colosian reinforcements are on the way, any freighter not off the board is swallowed up and should be considered destroyed for TPV purposes.

## Victory Conditions

As in Battle 1, scenario victory is secondary to overall mission goals. For the scenario, add up the TPV of ships destroyed on each side, the highest total wins.

Campaign points revolve around the freighters' attempts to reach edge 1 by the 17th turn. Each freighter is worth 50 campaign points: if it's destroyed, the Colosian player nabs the points, if it makes it off the edge of the board, the Sigurd forces earn the prize.

## Battle 3: Loki's Ruse

**Date:** AL12:214

**Location:** Inside Sigurd/Colosian border's disputed area

**Situation:** Political tension rises as the border skirmish escalates. The Colosians moved two escorts, the Jessup and the Aldermain, to the edge of the belt to act as a "deterrent" to further Sigurd aggression. The Colosian command doesn't understand Sigurd mentality—the destroyers are a prize of honor, to crush them is worth the loss of many fighters. Besides the honor, destroying the Warhounds opens up a clear avenue for the 23rd Sigurd Heavy Flotilla "Odin's Thunder" to move in and take a tactical as well as a clearly defensive posture near the mining facility.

The carrier Loki moved into launch position late on AL12:213. The Sigurds mean business—both Loki's Kids and the Valkyrie wings are on board, ready to fly. Loki's kids earned the honor of assaulting the Jessup and the Aldermain. The Colosian ships remain close enough to the carrier Stalwart to enjoy regular fighter support.

True to form, Loki's Kids will employ creative tactics in this battle. The battle takes place at the edge of the asteroid field. A high concentration of dust and radioactive ore render long-range scanners ineffective. Problem Child and Li'l Devils squads perform a frontal assault intended to absorb the destroyers' fighter support, while the Delinquents squad hopes to surprise the Colosians and let fly with a barrage of Blizzard and Pit Viper II torps.

### Forces

#### Sigurd L-01 "Loki's Kids" Problem Child (TPV: 834)

##### Squadron Leader:

Leif Hedin (Pharsii II A)

Begin within five hexes of edge 3's top corner.

|              |  |
|--------------|--|
| Pharsii II A | Pilot (Plt 8, Gnr 5, Lck 5)<br>Gunner (Gnr 8)<br>Gunner (Gnr 6)  |
| Pharsii II B | Pilot (Plt 6, Gnr 5, Lck. 1)<br>Gunner (Gnr 7)<br>Gunner (Gnr 7)   |
| Pharsii II C | Pilot (Plt 8, Gnr 8)<br>Gunner (Gnr 9)<br>Gunner (Gnr 5)   |
| Hound A      | Pilot (Plt 6, Gnr 7, Lck 2)  |
| Hound B      | Pilot (Plt 7, Gnr 8)   |
| Hound C      | Pilot (Plt 8, Gnr 6)   |
| Hound D      | Pilot (Plt 7, Gnr 7)   |
| Iceberg A    | Pilot (Plt 6, Gnr 3, Lck 2)<br>Gunner (Gnr 7)<br>Gunner (Gnr 6)<br>Gunner (Gnr 5)<br>Gunner (Gnr 10)<br>Gunner (Gnr 6) |

#### Li'l Devils (TPV: 495)

##### Squadron Leader:

Joren Kirgarten (Night Hawk A)

Begin within five hexes of edge 3's bottom corner.

|              |                       |
|--------------|-----------------------|
| Dagger A     | Pilot (Plt 7, Gnr 7)  |
| Dagger B     | Pilot (Plt 8, Gnr 6)  |
| Dagger C     | Pilot (Plt 4, Gnr 5)  |
| Dagger D     | Pilot (Plt 6, Gnr 3)  |
| Night Hawk A | Pilot (Plt 9, Gnr 9)  |
| Night Hawk B | Pilot (Plt 6, Gnr 5)  |
| Night Hawk C | Pilot (Plt 7, Gnr 9)  |
| Night Hawk D | Pilot (Plt 6, Gnr 10) |

# The Next Millennium

## Sigurd Naval Com- mand Hi- erarchy

**Admiral:** Single person, commander of entire navy, second only to Guttman.

**Sub-Admiral:** Numbers range between 10 and 15 at any given time. Sub-Admirals assist the Admiral in overall policy and strategy. The Admiral and his sub-admirals make up the Naval Command, but Sigurd strategy stresses independent decision-making abilities. Naval Command creates overall strategy, which is then interpreted by the descending command hierarchy.



# Silent Death

**Commodore:** Handles all functions within a given sector. Commands all forces within that sector, given broad powers to decide best local course of action.

**Colonel:** Controls an entire fleet or task force. Usually a single task force patrols each sector, but there may be as many as four. Colonel's are subordinate to Sector General, but has very independent control of fleet's defense, offensive action and day-to-day activities. A Colonel resides on a fleet or task force's flagship, commands that unit and not the ship.



## Delinquents (TPV: 762)

### Squadron leader:

|                                 |                               |
|---------------------------------|-------------------------------|
| Yngvi Badjlkstaf (Glaive III A) |                               |
| Blizzard A                      | Pilot (Plt 6, Gnr 7, Lck. 2)  |
| Blizzard B                      | Pilot (Plt 8, Gnr 4, Lck. 3)  |
| Blizzard C                      | Pilot (Plt 5, Gnr 10, Lck. 4) |
| Blizzard D                      | Pilot (Plt 7, Gnr 7)          |
| Pit Viper II A                  | Pilot (Plt 6, Gnr 5)          |
| Pit Viper II B                  | Pilot (Plt 8, Gnr 8)          |
| Pit Viper II C                  | Pilot (Plt 3, Gnr 6)          |
| Pit Viper II D                  | Pilot (Plt 5, Gnr 7)          |
| Glaive III A                    | Pilot (Plt 6, Gnr 10, Lck 3)  |
| Glaive III A                    | Pilot (Plt 9, Gnr 5, Lck 2)   |
| Iceberg B                       | Pilot (Plt 7, Gnr 6, Lck 2)   |
|                                 | Gunner A (Gnr 9)              |
|                                 | Gunner B (Gnr 5)              |
|                                 | Gunner C (Gnr 6)              |
|                                 | Gunner D (Gnr 6)              |
|                                 | Gunner E (Gnr 8)              |

### Elements from 292nd Colosian Escort Flotilla, "Colosia's Best," Second squadron (TPV: 2118)

**Flight commander:** Clarence Teatherborn  
(Captain Narwhal A)

Begin within 15 hexes of edge 1.

|                |  |
|----------------|--|
| Narwhal A      | Captain (Cpt 1d8)<br>Pilot (Plt 8)<br>Gunner A (Gnr 5)<br>Gunner B (Gnr 6)<br>Gunner C (Gnr 4)<br>Gunner D (Gnr 7)<br>Crew E (Gnr 6)<br>Crew F (Gnr 9)<br>Crew G (Gnr 3) |
| Narwhal B      | Captain (Cpt 1d4)<br>Pilot (Plt 6)<br>Gunner A (Gnr 6)<br>Gunner B (Gnr 4)<br>Gunner C (Gnr 3)<br>Gunner D (Gnr 5)<br>Crew E (Gnr 8)<br>Crew F (Gnr 4)<br>Crew G (Gnr 5) |
| Seraph A       | Pilot (Plt 7, Gnr 4, Lck 1)<br>Gunner (Gnr 6)  |
| Seraph B       | Pilot (Plt 3, Gnr 3)<br>Gunner (Gnr 3)   |
| Deathwind A    | Pilot (Plt 6, Gnr 5, Lck 2)  |
| Deathwind B    | Pilot (Plt 7, Gnr 4, Lck 1)  |
| Deathwind C    | Pilot (Plt 5, Gnr 3)   |
| Deathwind D    | Pilot (Plt 4, Gnr 4)   |
| Spirit Rider A | Pilot (Plt 8, Gnr 5, Lck. 2)   |
| Spirit Rider B | Pilot (Plt 7, Gnr 6, Lck 1)  |
| Spirit Rider C | Pilot (Plt 6, Gnr 3)   |

|                |                      |
|----------------|----------------------|
| Spirit Rider D | Pilot (Plt 3, Gnr 7) |
| Spirit Rider E | Pilot (Plt 4, Gnr 2) |
| Spirit Rider F | Pilot (Plt 5, Gnr 1) |
| Spirit Rider G | Pilot (Plt 2, Gnr 3) |

## Special rules

- 1) This is a massive engagement, the biggest of the conflict to date. Double the map area if possible. With the number of fighters on the board, that additional space will greatly add to tactical decisions.
- 2) Technically, the Colosian player should know nothing about the Delinquents' position. With most gamers, of course, keeping a squad secret is difficult if not impossible. The Sigurd player should secretly write down a turn number between 4 and 10, and also a map edge number. Fold that paper so it can't be read and put it where all can see. When the time comes, the Sigurd player may unveil his choices and deploy his forces on the turn and map edge specified. The Colosian player will know another Sigurd squadron is out there, but won't know where or when it will strike.  
This technique makes it hard on the Colosian player, but that is the intention. If the Colosian player commits all his fighters in the first six turns, the Sigurd player has an open alley to knock out a Narwhal. If the Colosian player is tactically wise and holds some of his ships in reserve the Narwhals will probably live through the encounter.
- 3) Either side may withdraw at any time. Retreat, however, concedes victory to the opposition, which becomes important in Battle 4.

## Victory conditions

This one is simply a fight to the finish. Whoever holds the field at the end of the encounter is the winner. There is no time limit to the scenario.

## Battle 4: Trump Card

**Date:** AL12:215

**Location:** Inside Sigurd/Colosian border's disputed area

**Situation:** The belt is drifting into what is clearly Colosian territory. The Sigurds know they must have clear possession of the belt if their claim is to hold up with the bi-partisan Galactic Council. In short, they've run out of time and need clear possession now.

Sigurd engineers discovered a clearing near the middle of the asteroid belt, large enough to comfortably hold an escort flotilla and supporting fighters. If they place a flotilla in that clearing, the asteroid belt will act like fortress walls. Any attacking force will have to pass through hundreds of kilometers-thick asteroids—maneuverability will be minimal and the force would be exposed to fighter assault. Once inside the clearing, the Colosians will be hard pressed to remove the Sigurds from the tactically advantageous position.

With this in mind, the Colosians need to keep the Sigurds out. The first squadron of the 292nd Colosian Escort Flotilla's mission is to stop cold the advance of the 23rd Sigurd Heavy Flotilla, "Odin's Thunder." Asteroids pack even the easiest path into the clearing, making this battle a nightmare for Warhounds.

### Forces

#### 23rd Sigurd Heavy Flotilla "Odin's Thunder" Thor Squadron (TPV: 3148)

##### Squadron Leader:

Barik Svenson (Longboat A)

Start within 10 hexes of edge 3

|            |                   |
|------------|-------------------|
| Longboat A | Captain (Cpt D8)  |
| Blood-Axe  | Pilot (Plt 6)     |
|            | Gunner A: (Gnr 7) |
|            | Gunner B: (Gnr 5) |
|            | Gunner C: (Gnr 6) |
|            | Gunner D: (Gnr 8) |
|            | Gunner E: (Gnr 4) |

Longboat B  
Berserker

Megafortress A  
Wartooth

Megafortress B  
Ol' Seven Fingers

Pit Viper II A  
Pit Viper II B  
Pit Viper II C  
Pit Viper II D  
Pit Viper II E

#### 292nd Colosian Escort Flotilla "Colosia's Best" Second Squadron (TPV: 3233)

##### Squadron Leader:

Mark Chadwick (Fletcher)

Start within 10 hexes of edge 1

|          |                   |
|----------|-------------------|
| Fletcher | Captain (Cpt D8)  |
| Guardian | Pilot (Plt 7)     |
|          | Gunner A: (Gnr 4) |
|          | Gunner B: (Gnr 5) |
|          | Gunner C: (Gnr 7) |
|          | Gunner D: (Gnr 3) |
|          | Crew E: (Gnr 4)   |
|          | Crew F: (Gnr 7)   |
|          | Crew G: (Gnr 5)   |

|                              |
|------------------------------|
| Crew F: (Gnr 6)              |
| Crew G: (Gnr 3)              |
| Crew H: (Gnr 6)              |
| Crew I: (Gnr 4)              |
| Crew J: (Gnr 8)              |
| Captain (Cpt D4)             |
| Pilot (Plt 7)                |
| Gunner A: (Gnr 5)            |
| Gunner B: (Gnr 6)            |
| Gunner C: (Gnr 4)            |
| Gunner D: (Gnr 10)           |
| Gunner E: (Gnr 5)            |
| Crew F: (Gnr 4)              |
| Crew G: (Gnr 9)              |
| Crew H: (Gnr 7)              |
| Crew I: (Gnr 7)              |
| Crew J: (Gnr 4)              |
| Captain (Cpt d4)             |
| Pilot (Plt 7)                |
| Gunner A: (Gnr 10)           |
| Gunner B: (Gnr 4)            |
| Gunner C: (Gnr 4)            |
| Gunner D: (Gnr 6)            |
| Gunner E: (Gnr 5)            |
| Crew F: (Gnr 4)              |
| Crew G: (Gnr 9)              |
| Crew H: (Gnr 3)              |
| Captain (Cpt d4)             |
| Pilot (Plt 7)                |
| Gunner A: (Gnr 5)            |
| Gunner B: (Gnr 6)            |
| Gunner C: (Gnr 8)            |
| Gunner D: (Gnr 5)            |
| Crew F: (Gnr 7)              |
| Crew G: (Gnr 5)              |
| Crew H: (Gnr 3)              |
| Pilot (Plt 4, Gnr 4, Lck. 2) |
| Pilot (Plt 5, Gnr 3)         |
| Pilot (Plt 6, Gnr 5)         |
| Pilot (Plt 3, Gnr 3)         |
| Pilot (Plt 4, Gnr 4)         |

# The Next Millennium

**Captain:** Commands a single ship. This is a very powerful position in the Sigurd Navy; the captain handles all discipline problems. Strict captains often vent problematic enlisted men. Discipline on Sigurd ships is extremely high and there are few problems. Sigurd captains always go down with the ship.

**Executive Officer (XO):** Second-in-command to the captain. The XO handles most of the ship's day-to-day functions, while the captain handles overall policy and strategy.

**Huginn:** Each ship above gunboat class carries an Odinite priest known as Huginn. The Huginn is a full member of the crew and often acts as a



# Silent Death

gunner. He carries out daily religious services, counsels the crew, advises the captain and the XO on religious ramifications of any situation. Many men move from Huginn into the ranks of captain. Huginn is the Old-Norse name for thought.

**Bilskirnir:** Subordinate to the XO and handle day-to-day activities for the various crews aboard the Warhounds, Carriers and Capitol ships. Bilskirnirs break down into three grades.

**Bilskirnir Grade One:** Command whole sections of the ship, such as engineering, weaponry, fighter maintenance, etc.



|                           |   |
|---------------------------|---|
| Stingray A<br>Magic       | Crew H: (Gnr 3)<br>Captain (Cpt D4)<br>Pilot (Plt 5)<br>Gunner A: (Gnr 3)<br>Gunner B: (Gnr 8)<br>Gunner C: (Gnr 9)<br>Crew D: (Gnr 4)<br>Crew E: (Gnr 5)<br>Crew F: (Gnr 8)<br>Crew G: (Gnr 2) |
| Stingray B<br>Blue Maiden | Captain (Cpt D6)<br>Pilot (Plt 9)<br>Gunner A: (Gnr 4)<br>Gunner B: (Gnr 3)<br>Gunner C: (Gnr 5)<br>Crew D: (Gnr 8)<br>Crew E: (Gnr 9)<br>Crew F: (Gnr 3)<br>Crew G: (Gnr 4)                    |
| Aosho<br>Piggyback        | Captain (Cpt D4)<br>Pilot (Plt 7)<br>Gunner A: (Gnr 9)<br>Gunner B: (Gnr 3)<br>Gunner C: (Gnr 4)<br>Gunner D: (Gnr 3)<br>Gunner E: (Gnr 10)<br>Crew F: (Gnr 6)<br>Crew G: (Gnr 8)               |
| Hellbender A              | Pilot (Plt 6, Gnr 4, Lck 2)   |
| Hellbender B              | Pilot (Plt 5, Gnr 5)  |
| Hellbender C              | Pilot (Plt 4, Gnr 7)  |
| Hellbender D              | Pilot (Plt 7, Gnr 3)  |
| Hellbender E              | Pilot (Plt 2, Gnr 3)  |
| Hellbender F              | Pilot (Plt 9, Gnr 4)  |

## Special rules

- 1) The gap through the field closes by the minute due to the constantly shifting asteroids. The Sigurds have 15 turns to leave through edge 1.
- 2) Any ships still on the board after the 15th turn must take evasive action and leave the asteroid belt, thereby ending the encounter.
- 3) Colosians may not retreat at any time.
- 4) The Hell Benders are from the Piggyback.
- 5) While asteroid density per cubic kilometer in this area of the belt is lighter than normal, it is still fraught with danger. Randomly place 20 asteroid markers on the map, and place an additional 10 randomly within 10 hexes of edge 1.

- 6) Colosian reserves: If the two Narwhals held the field in Battle 3, they will start Battle 4 within five hexes of the map's center. The Colosian player may use them as he wishes.
- 7) Sigurd reserves: Loki's Kids CO Nate Finnbogi held a small force in reserve to cover a potential withdrawal. If the Sigurds won Battle 3 and did not have to withdraw, Finnbogi will send that reserve force to assist the 23rd Flotilla.

## Loki's Kids reserves

|                    |  |
|--------------------|--|
| Pharsii II D       | Pilot (Plt 8, Gnr 8)<br>Gunner (Gnr 9)<br>Gunner (Gnr 5) |
| Pit Viper II F     | Pilot (Plt 7, Gnr 7)                                     |
| Pit Viper II G     | Pilot (Plt 7, Gnr 7)                                     |
| Pit Viper II H     | Pilot (Plt 7, Gnr 7)                                     |
| Pit Viper II I     | Pilot (Plt 7, Gnr 7)                                     |
| Spirit Rider III A | Pilot (Plt 3, Gnr 6)                                     |
| Spirit Rider III B | Pilot (Plt 5, Gnr 7)                                     |

## Overall victory conditions

The main elements to this campaign are the mining facility and the Sigurd force moving into the easily defensible clearing. If the Sigurds have either one of these elements in place, they have a reasonable claim to the belt's resources although it's drifting into Colosian space. If the Sigurds have both of these elements in place, they are the clear-cut winners.

If the Colosians destroyed the mining facility but didn't stop the 23rd, they can make the claim that the Sigurds have nothing but military interests. Pressure from the other 10 houses would force the Sigurds to leave. This is important because the Colosian command doesn't want to go into the asteroid field after the Sigurd Warhounds: the cost in lives and ships would be stunning.

If the Colosians stopped the 23rd but didn't destroy the mining facility, then the Sigurds will be allowed to continue mining. The Galactic Conference will force the Sigurds and Colosians to make some kind of trade agreement regarding the belt's resources.

If the Colosians destroy the facility and stop the 23rd from reaching the clearing, they win hands down.

# Nomenclature

Unlike ship designs found in *SD:TNM*, the seven fighters listed below are the sole property of the Sigurd Archdiocese. The Sigurd government plays these designs close to its vest, domestically producing all their ships and either making or jobbing out the parts. Most of these ships use standard weaponry for economic purposes.

While the Sigurds protect their designs in shrouds of secrecy, a few non-Sigurds do have access to the ships. A few fly in Sunrunner wings.

A number of off-worlders would pay handsomely for the designs, or for a ship that could be dismantled and studied. Anyone who could smuggle ships or designs out of the Archdiocese would be a very rich person indeed.

## Brawn Factories SIG204-B “DAGGER”

**Crew:** 1

**Maneuvering Thrust:** 0.144 km/s/s

**Mass:** 394 Tons

**Translight Capability:** None

**Armor:** Fortified Crysteel

**Atmospheric Capability:** Full

**Armaments:**

1x Mk. 10 Mjöltnir Gauss Generator

1x Missile Launcher (Magazine: 20)

1x Mk. 20 Meld Laser

Brawn Factories' luck continued with its second design, a craft Charles Brawn originally created for the Imperial Navy. The Dagger combines elements of the Hound with

more armor and innovative use of a 20-round missile rack (known as a “burp pod”). All of this comes at a sacrifice of speed.

The Dagger is an attrition-fighter killer, a specialist in knocking out the Spirit Riders, Darts and Pit Vipers that dot the combat arenas of the Galaxy. Using its missile-launcher in five-shot bursts, it slows smaller fighters allowing effective use of bigger guns. The Dagger's Gauss Field Generator is a light fighter's nightmare, as it hits even the highest of defensive values. Put a decent pilot in a Dagger, and you can count on it for at least two light-fighter kills per engagement.

Daggers aren't all that effective against larger ships, although the Meld Laser can certainly wear on opponents. The Dagger doesn't have staying power against concentrated fire from larger ships. The Dagger's is best at obliterating light fighters. The Dagger is a team player: use it in conjunction with larger fighters that normally have a tough time hitting light fighters. The dagger's main goal is to slow fighters down. It should be able to hurt two light fighters per turn, one with missiles and one with the GFG.

The ship's design keeps durability in mind. Solid point-defense helps control torps that often come courtesy of smaller fighters. A decent damage reduction and reliable damage control usually mean this ship will live through the encounter. To add to this, Brawn factories added an armored cockpit, helping insure the lives of the pilots. Because of the ship's durability and it's knack for knocking out multiple light fighters, Dagger pilots tend to rack up obscene amounts of kills.

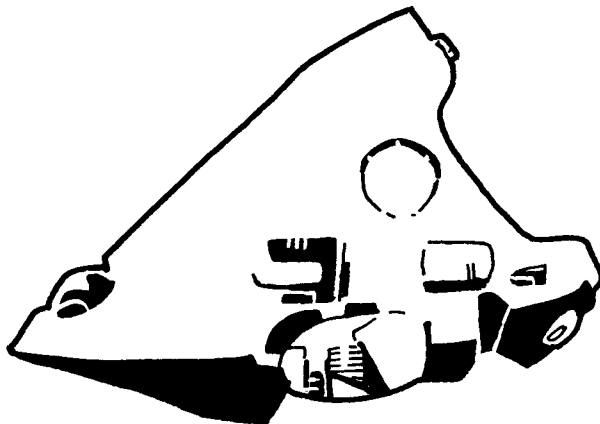

# The Next Millennium

**Bilskirnir Grade Two:** Responsible for overall administration of individual ship components such as the helm cannon, ECM, armor integrity, launch tubes, etc.

**Bilskirnir Grade Three:** Chief and member of the rotating crews that man individual components such as gunnery crews, repair crews, maintenance crews, etc.

**Oarsman:** The countless legions that crew Sigurd ships. Oarsman is the equivalent of an army private, but still held high esteem both from the general populace and from superior officers.





## Brawn Factories SIG 100-A "HOUND"

**Crew:** 1  
**Maneuvering Thrust:** 0.171 Km/s/s  
**Mass:** 203 tons  
**Translight Capability:** None  
**Armor:** Crysteel with belt  
**Atmospheric Capability:** Full  
**Armaments:** 2x Mk. 20 Torps  
1x Mk. 10 Impulsegun Ion Cannon

The first ship design accepted by the Sigurd Archdiocese government was also the first one submitted. Brawn Factories answered the call for a ground-launchable attrition fighter to protect the poorly developed House, which at the time had no orbital stations or carriers.

The first design submitted proved to be the most durable. Fast and tough with a two-torp punch, the Hound design is synonymous with Sigurd forces. All pilots earn their wings by first flying a Hound.

Sigurds use the ship for quick strikes, a lead jab to soften up defenses. Hounds often fly in conjunction with the heavily armored Storm. Once opposing ships use up their missiles on the heavy-hitters, the Hounds rush in and take the enemy apart piece by piece.

## Deussenson KA-27 "HAMMER"

**Crew:** 2  
**Maneuvering Thrust:** 0.136 km/s/s  
**Mass:** 415.7 Tons  
**Translight Capability:** None  
**Armor:** Crysteel  
**Atmospheric Capability:** Full  
**Armaments:**  
4x Mk. 10 Torps  
4x Mk. 20 Torps  
1x Mk. 15 Ion Ram  
1x Mk. 10 Mjöltnir Gauss Generator

Rassen Deussenson founded Deussenson Yards, the first true rival of Brawn Factories. Founded on Midgard in Imp 502. Deussenson Yards battled for the contract to fill a void in the Sigurd fighter lineup.

While the Dagger's effectiveness was devastating against light fighters favored by pirates, drawn-out engagements found the Sigurds weakening, losing battles in the late rounds when they had dominated early on. Answering the call for a fighter that could hang and bang through an entire engagement, Rassen submitted the design for the Hammer. This ship, along with the Hound, is a signature model of the Archdiocese. The two models often fly in tandem, as they make a highly effective pair.

The Hammer's massive damage track gives it durability, while the Ion Ram gives it long-range dogfighting punch. The torp load often overwhelms opponents.

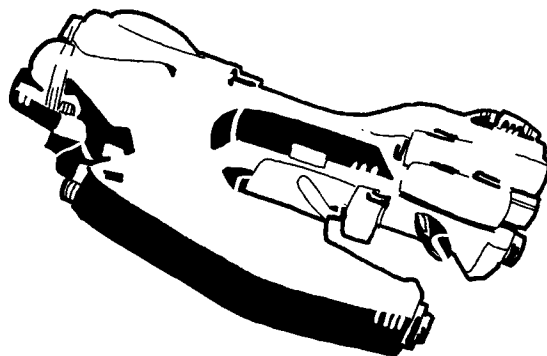
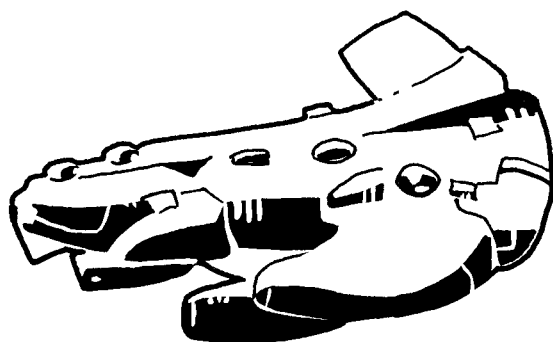

## Deussenson KAJ-B "STORM"

**Crew:** 3

**Maneuvering Thrust:** 0.141 km/s/s

**Mass:** 995 Tons

**Translight Capability:** 7.2 light-years/day

**Armor:** Crystantium w/belt

**Atmospheric Capability:** Full

### Armaments:

2x Missile Launcher (Magazine: 20)

2x Mk. 10 Blatgun Blast Cannons

1x Mk. 15 Gungnir Gauss Generator

1x Mk. 10 Impulsegun Ion Cannon

Deussenson wanted his Storm to be Midgard's answer to the Pharsii II. Major problems, however, plagued the Storm from day one. Designers intended the MPAC ship as a devastating new concept—a heavy yet maneuverable fighter with translight capability, a strike vessel free of expensive carrier support.

Instead the Sigurds got a slow fighter with severe weakness in the rear right and rear left arcs, making it vulnerable to attacks by quick, hard-to-hit attrition fighters. To make matters worse, most of the Storm's weaponry can't hit fast ships. While the Storm packs a serious punch, the first unsupported test flight deep into House Colos territory found a trio of Storms decimated by a flight of seven Darts.

The Storm enjoyed some early raiding success, shredding any medium fighter it encountered. Opposing forces soon found, however, that cheap and easily replaceable

Dart swarms completely defended against Storms jumping down out of hyperspace. Storms are seldom sent out without wing support from Spirit Riders, Hounds, Daggers or the like.

## Deussenson KAJ-C "STORM II"

**Crew:** 3

**Maneuvering Thrust:** 0.131 km/s/s

**Mass:** 995 Tons

**Translight Capability:** none

**Armor:** Crystantium w/belt

**Atmospheric Capability:** Full

### Armaments:

2x Missile Launcher (Magazine: 20)

1x Mk. 15 Ion Ram

1x Mk. 15 Gungnir Gauss Generator

1x Mk. 10 Impulsegun Ion Cannon

A new variant of the Storm, the KAJ-C "Storm II" is in production. The extra combat ability comes at the cost of the translight drive, which in effect defeats the ship's original purpose. By dropping the FTL drive, engineers put in an upgraded tactical engine which increased the speed from 12 to 13, and kicked the damage control to 1-4 instead of 1-3. They replaced the Twin Blatguns with an Ion Ram. Also, engineers upgraded point defense to 1-8 (3), making the Storm II very tough to hit with Torps.

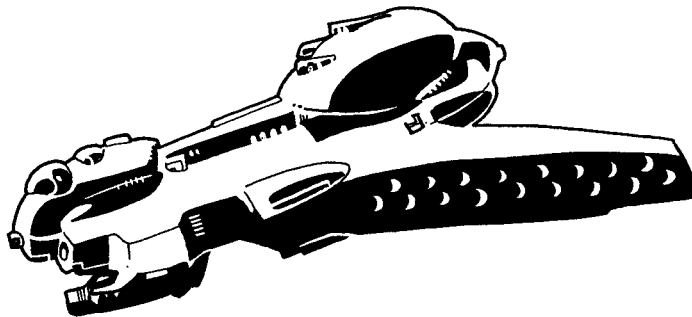

# The Next Millennium

## Fighter Wing Command Hierarchy

**Commander:** Subordinate to a Colonel when assigned to a fleet or Commodore when stationed on orbital stations or planets. The Commander administers all fighter wing activities. He also implements fighter strategy based on orders given to him by his superiors.

**Wing Executive Officer (WEO):** Second-in-command of a fighter wing. Handles the majority of administrative duties.

**Huginn:** Wing's religious leader. Usually wings have two or three Huginns, as



# Silent Death

they are pilots and often die in battle.

**Squadron Leader:** Responsible for individual squadron efficiency and strategy. Very broad powers of order interpretation in battle. Squad Leaders are taught to think for themselves and adapt quickly to unexpected situations.

**Viking:** A Sigurd pilot, possibly the most respected position in all the Archdiocese. The pilots are viewed as the grand warriors of old. Their exploits fill Sigurd newscasts, literature and all forms of entertainment.



## Pyramidis-Brawn S102 "LONGBOAT"

**Crew:** 35

**Maneuvering Thrust:** 0.081 km/s/s

**Mass:** 11,000 tons

**Translight Capability:** 19 light-years/day

**Armor:** Double Crystantium hull

**Atmospheric Capability:** none

**Armaments:**

12x Mk. 10 Splattergun Blast Cannons

2x Missile Launcher (Magazine: 20)

2x Mk. 25 Laztube

1x Mk. 10 Mjöltnir Gauss Generator

1x Mk. 40 Bifrost Gauss Generator

2x Twin tube torpedo room:

10x Mk. 10 torpedoes

20x Mk. 30 torpedoes

10x Mk. 70 torpedoes

Only Sigurds call this destroyer the Longboat. The rest of the galaxy knows it as The Beast.

The Longboat is one of the first escorts to challenge the Fletcher's dominance of space combat. Weighing in at 11,000 tons and sporting amazing firepower, the Longboat is built to last. The Gauss Phaser's devastating impact shreds anything in the Longboat's direct path, while dual Laztubes soften up foes from a distance. Any fighter foolish enough to move in faces a murderous barrage from twin pairs of missile launchers, quad- and dual-Splatterguns. The Longboat's full frontal sweep with a Gauss Field Generator doubles as a fighter-killer and a torpedo-stopper.

In the early days of Guttman's reign Midgard possessed no Warhound-capable shipyards. The Archdiocese needed tough, long-lasting ships to support fighter wings and defend Midgard. The Sigurd demand for the durable Megafortress made many Pyramidis Shipyards execs incredibly wealthy.

As the Archdiocese economy grew and money poured into the defense budget, the Sigurd naval command demanded larger ships to patrol the expanding House's interests and to protect carriers. While the Fletcher's power looked appealing, it didn't have the armor of the Megafortress. In addition, rumors abounded that Heavy Metal shipyards produced Primate Warhounds. This combination resulted in the Sigurd decision to domestically produce Warhounds.

Charles Brawn collaborated with the Pyramidis staff to produce the Longboat design. Manufactured above Midgard, Kamchatka and New Denmark, the Archdiocese placed dozens of these massive ships in service in the last 15 years. Only a militarily based economy such as the Sigurd's could produce large numbers of this enormous ship, which currently ranks as the galaxy's largest destroyer.

While able to build rapidly, Guttman wants value for his money. The Longboat is designed to last. Heavy armor and a decent engineering crew help achieve that goal. In the past decade, the Sigurds didn't have large numbers of support ships, and as such the Longboat had to stand on its own for extended voyages. Double Laztubes allow the Longboat to engage multiple foes. Now that the Archdiocese economy pumps at high gear, few Longboats venture out without support from Megafortresses or flanking Narwhals.

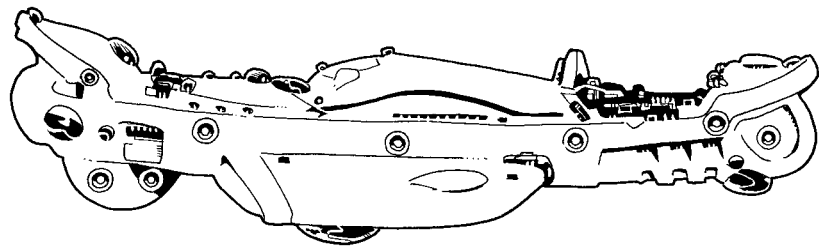

## **Brawn Factories BRN-72D "ICEBERG"**

**Crew:** 6

**Maneuvering Thrust:** 0.111 km/s/s

**Mass:** 1501.3 Tons

**Translight Capability:** 6.2 light-years/day

**Armor:** Ablative Crystantium

**Atmospheric Capability:** None

**Armaments:**

6x Mk. 20 Torps

6x Mk. 30 Torps

4x Mk. 20 Autocannon (Magazine: 8)

2x Mk. 15 Ion Ram

2x Mk. 10 Mjöltnir Gauss Generators

1x Mk. 15 Gungnir Gauss Generator

2x Missile Launcher (Magazine: 20)

After Deussenson's fiasco with the Storm, he could have submitted the galaxy's greatest design and not received a contract. That he competed against Charles Brawn's latest creation didn't make things easier.

Brawn's Iceberg, a radical departure from his light-fighter past, is just as successful a design as the Hound and Dagger. Brawn Factories built its reputation with fighters that were low-cost, well-constructed and easy to repair. The Iceberg is anything but that. Expensive and massive, this gunboat is well worth the price. More advanced and deadly than a Drakkar, the 'Berg provides fire support for all Sigurd ships and balances out the Dagger's lack of staying power. Daggars often use the 'Berg as a shield, ripping into a battle, knocking out light fighters, then retreating behind the protective cover of the 'Berg's murderous barrage. Carrying missiles, torps, two Gauss Field Generators to knock out speedy fighters and quad Autocannons to knock out everybody else, the 'Berg is the deadliest fighter in the Sigurd arsenal.

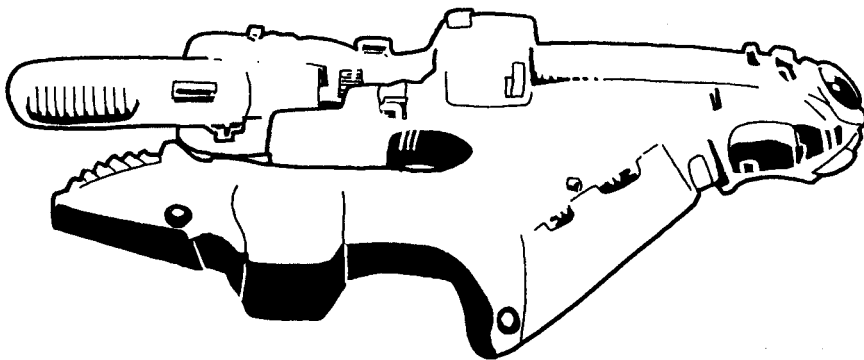

# The Next Millennium

"Today is a good day to die. But then so was yesterday, and hey, tomorrow looks good too."

- Unofficial motto of the 201st Missionaries of Death



## Sigurd Refits

### YK Shipyards Y700.YK "SPIRIT RIDER III"

**Crew:** 1

**Maneuvering Thrust:** 0.154 km/s/s

**Mass:** 125 tons

**Translight Capability:** none

**Armor:** Crysteel

**Atmospheric Capability:** special

**Armaments:**

4x Mk. 10 Splattergun Blast Cannons

This ship sees limited service in the Archdiocese. Modified from the classic Spirit Rider, the Spirit Rider III originally protected the gaseous world of Yarak-Tull. The planet's highly corrosive atmosphere, gale-force winds and merciless electrical storms devastate any craft. The Spirit Rider III dives in and out of this soupy danger, fighting medium-range sorties away from the planet as well as devastating any force foolish enough to enter the Yarak-Tull atmosphere.

Most of the modifications have little impact on scenarios played away from Yarak-Tull. Any non-modified ship flying in Yarak-Tull's atmosphere faces a -4 to hit on every roll, adds +2 to the tight turn cost and takes a critical hit on a roll of 1-3 on a 1D10 every turn. Torps cannot lock in the atmosphere due to electrical interference, and missiles can only be launched from five hexes away. Beam weapons suffer an additional -2 at a range of 10 hexes or greater.

Spirit Rider III shipyards do a boom business with the design, exporting it to gaseous planets throughout the galaxy. The Bokchito Collective (see Sunrunners) is a major customer. The ship is perfectly capable of fighting in normal space, and surplus vehicles often find their way into normal Sigurd wings. The Missionaries of Death are particularly fond of the design, as its lack of torps forces up-close-and-personal dog-fighting. Spirit Rider IIIs pack a severe punch for a light fighter, but fall apart faster than a traditional Spirit Rider.

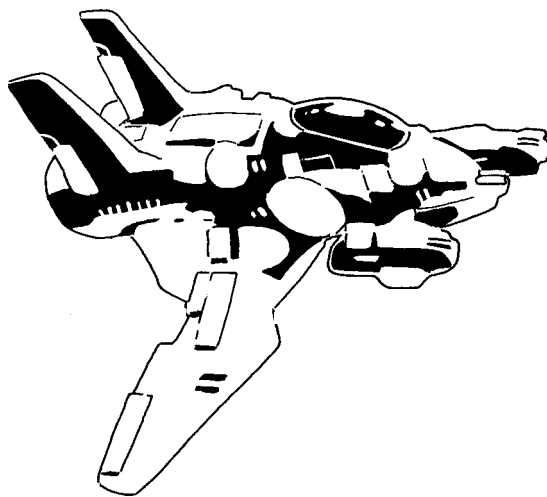

## Jasper Machines Y910b G1/U3 "GLAIVE III"

**Crew:** 2

**Maneuvering Thrust:** 0.129 km/s/s

**Mass:** 900 tons

**Translight Capability:** none

**Armor:** Reinforced Crysteel

**Atmospheric Capability:** none

**Armaments:**

1x Mk. 10 Plazgun Plasma Cannon

1x Mk. 10 Splattergun Blast Cannon

1x Mk. 20 Gungnir Gauss Generator

1x Missile Launcher (Magazine: 20)

2x Mk. 40 torpedoes

Many commanders and squadron leaders abhor using the Storm fighter, yet leaving it behind often means no heavy fighter support. The military mind, however, is often unfathomable; for years the Sigurd command refused to re-tool Storm production lines in favor of another model.

Sigurd records credit Tory Pyte, commander of the carrier Ymir, and his chief engineer Bjorn Olafsson with the Tornado's creation. In battles against skilled pirates, Pyte lost ship after ship due to the Storm's pronounced weaknesses. The pirates' tough Seraphs demolished Storms at every turn. Fed up with the situation, Pyte purchased a squadron of captured Glaives from the Sunrunners and turned them over to Olafsson.

Olafsson dropped one of the Mk-40s and one of the missile racks to lighten the load and increase speed. They also scrapped the Protobolt Projector in favor of a Gauss Blaster, providing increased range and staying power. While a trifle slower and more expensive than the Storms, the modified Glaives turned the tide against the pirates. Since then Sigurd commanders snatch up Glaives at every opportunity and make the modifications.

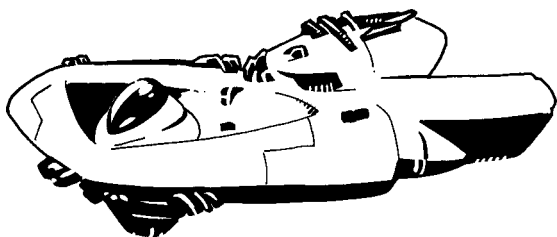

## Vott-Messerschmitt VMe. SA "PIT VIPER II"

**Crew:** 1

**Maneuvering Thrust:** 0.175 km/s/s

**Mass:** 90 tons

**Translight Capability:** none

**Armor:** Crysteel

**Atmospheric Capability:** Full

**Armaments:**

2x Mk. 8 Pulse Laser Cannons

3x Mk. 30 explosive torpedoes

If there's one ship enemies of the Sigurds dread, it's the Pit Viper II. This souped-up Pit Viper drops a Pulse Laser and a point of speed in order to mount order to mount three Mk. 30s. The 18 drive makes the Pit Viper II is the fastest medium-torp delivery system in Terran space. With no staying power and light damage capability, its purpose is rather obvious: close to point-blank range and deliver the torp payload.

Pit Viper IIs are more expensive than Pit Vipers, but their potential for damage is much higher. The ship's survival rate is poor, and only the wildest, most fanatical pilots tend to fly them. In Sigurd space, however, there is no shortage of volunteers. For important, must-win missions, Sigurd command often throws 8-10 Pit Viper IIs at an enemy. They are particularly effective against Warhounds. Against the Escort-class ships, Pit Viper IIs close in a large pack and release all torps at once, insuring that at least some of the payload will get through.



# The Next Millennium

"Valhalla here we come!"

- Commonly shouted by Missionaries of Death pilots upon mission launch.



## Worlds of the Sigurd Archdiocese

### Midgard

**System:** Clesor

**Class:** Planet

**Natural Satellites:** Rama, Ice

**State:** Sigurd Archdiocese

**Status:** System capitol

**Autonomy:** Full

**Environment:** Frigid

**Habitat:** Normal, sealed cities

**Gravity:** 1.3

**Atmosphere:** Thick

**% H2O:** 56

**Mean Temp:** 00 lat: s 45 / w -50  
450 lat: s 30 / w -90

**Diameter:** 15,230 km

**Axial Tilt:** 75

**Day:** 18.2 hours

**Year:** 401 Days

**Danger:** Haas-Greebold asteroid belt,  
AL 620

**Race:** Odinian

**Population:** 6.5 billion

**Social Adaptations:** Highly disciplined

**Trade:** Industrial, mineral

**Government:** Parliamentary monarchy

**Notes:** Midgard is the capitol seat of the Sigurd Archdiocese and the Church of Odin. The planet once blossomed under the skilled hand of the Midgard Consulate, but an asteroid cluster devastated the planet in Imp 129. The Haas-Greebold cluster orbits Clesor every 912 years, and Midgard snares many of its innumerable asteroids. The planetary bombardment lasted four years, by which time the Consulate government was all but devastated. A band of rebels funded by the Church of Odin overthrew the government shortly after the asteroid belt passed. Until Günther Guttman



claimed the title of High Priest, the Sigurd Archdiocese ruled isolated and untouched for almost 400 years.

Much of Midgard is frigid, with very little flora or fauna. Few things grow where water freezes solid for three quarters of the year. The planet's crust is rich with mineral wealth, from both indigenous deposits and asteroid impacts. This mineral wealth fueled Midgard's resurgence.

The planet's people are incredibly hardy and disciplined. High gravity makes for a large, strong people, all toughened by Midgard's desolate environment and religious devotion.

## Simbulia

**System:** Reiger

**Class:** Planet

**Natural Satellites:** None

**State:** Sigurd Archdiocese

**Status:** Full member

**Autonomy:** Partial

**Environment:** Temperate, natural

**Habitat:** Varied

**Gravity:** 0.97

**Atmosphere:** Normal

**% H2O:** 66

**Mean Temp:** 00 lat: s 95 / w 25  
450 lat: s 65 / w -20

**Diameter:** 7,200 km

**Axial Tilt:** 85

**Day:** 14 hours

**Year:** 212 Days

**Danger:** None

**Race:** Odinian, Regain

**Population:** 2.9 billion

**Social Adaptations:** Highly disciplined

**Trade:** Agricultural, industrial

**Government:** Parliamentary monarchy

**Notes:** Simbulia is part of the Reiger system, which also contains life-supporting Reiger 6. Simbulia once served as the food capitol of the Deep Hosk Congress, a house destroyed by the Brood. While Simbulia continues to serve its food-producing role for the Sigurd Archdiocese, it also enjoys the benefits of a vastly improved industrial complex.

Temperate weather and year-round growing seasons bless the planet. Creamoss, which grows only on Simbulia and Reiger 6, is a highly nutritious source of livestock feed. Creamoss grows year-round and rapidly, allowing Simbulia to support enormous herds of Creabeast, Redrats and Yellowrats. There are at least 15 heads of livestock for every person on the planet. This bounty feeds the Archdiocese while the military stashes surplus in countless War Caches. Anything left over earns a high price on the galactic market.

## Reiger 6

**System:** Reiger

**Class:** Planet

**Natural Satellites:** Sixone, Sixtwo, Sixthree, Sixfour

**State:** Sigurd Archdiocese

**Status:** Full member

**Autonomy:** Partial

**Environment:** Temperate

**Habitat:** Natural

**Gravity:** 1.15

**Atmosphere:** Normal

**% H2O:** 71

**Mean Temp:** 00 lat: s 65 / w 60  
450 lat: s 50 / w 42

**Diameter:** 10,103 km

**Axial Tilt:** 12

**Day:** 32 hours

**Year:** 118 Days

**Danger:** None

**Race:** Rigerian, Odinian

**Population:** 17 billion

**Social Adaptations:** Highly disciplined

**Trade:** Industrial

**Government:** Parliamentary monarchy

**Notes:** Little has changed on Reiger 6 over the last 450 years. The planet produces goods at a prodigious rate, no matter what government rules over its people. Imperial forces founded the planet in Imp 150. Fifty years later the Ottoman Syndicate bought Reiger 6 and Simbulia, adding their agricultural and industrial bounty to the Syndicate's ranks. The two planets comprised the backbone of Ottoman power well into Imp 272, when the Syndicate incurred the wrath of the Ptolmean

# The Next Millennium

Compromise is for those unwilling to die in defense of their beliefs."

- Günther Guttman





# Silent Death

Empire. Ptolmeans ruled the Reiger System until Imp 312 when Deep Hosk Congress preyed on Ptolmean misfortunes. The Congress relied heavily on the two planets right up until the Brood invasion. After the Brood's defeat, the Sigurd Archdiocese claimed the rights to both worlds.

Oddly enough, neither planet ever witnessed a day of violence. The land and sky of both planets remained free from conflict. While governments warred over the prizes of the Reiger system, they never warred on them.

As such, Reiger 6 has reaped the rewards of 450 years of peace. The majority of the planet houses either highly functional industrial centers or idyllic residential communities. A dense population packs Reiger 6. Impeccably engineered, layered cities jut forth from the surface, most reaching over 400 stories tall. The weather patterns are free of any truly devastating effects, tectonics are highly stable, and the atmosphere protects from any foreign bodies. Regardless of Imperial woes or governmental conflicts, production goes on at a steady pace.

## Kamchatka

**System:** Christoff CV-19.

**Class:** Moon

**Natural Satellites:** None

**State:** Sigurd Archdiocese

**Status:** Full member

**Autonomy:** Partial

**Environment:** Arid

**Habitat:** Barren, underground cities

**Gravity:** 1.8

**Atmosphere:** Thick

**% H2O:** 41

**Mean Temp:** 00 lat: s 312 / w 178  
450 lat: s 303 / w 132

**Diameter:** 5,565 km

**Axial Tilt:** 112

**Day:** 45 hours

**Year:** 782 Days

**Danger:** Severe volcanism

**Race:** Odian

**Population:** 867 million

**Social Adaptations:** Highly disciplined

**Trade:** Mineral, Tiberium processing

**Government:** Parliamentary monarchy

**Notes:** Kamchatka is a difficult place to live. Under the surface, however, lies a treasure-trove of mineral wealth. Kamchatka holds vast stores of precious metals, isotopes, communication-grade gems and Tiberium deposits. Hardy souls reap daily fortunes, ignoring rampant danger posed by a rapidly shifting crust.

Originally founded by the Midgard Consulate, Kamchatka became part of the Ewanoma Cluster after the Haas-Greebold cluster ripped Midgard to shreds. Kamchatka produced strongly for the Cluster until the Brood devastated the tiny Ewanoma military. Apparently too hostile for even a Brood warren, the Swarm bombarded the planet's surface and then left. Many of the deeply-buried cities escaped complete destruction, but Brood damage was extensive. The Brood obliterated all major transportation routes, destroyed all five ports and crippled communications. Without food and supplies from the now non-existent Cluster, Kamchatka faced peril.

Hastily constructed beacons broadcasted Kamchatka's call for help. The carrier Ymir picked up the distress signals, and the Archdiocese engineering core raced to the rescue. After a year of struggle, Kamchatka citizens surged past a mere survival status and started to rebuild their home. They instantly ratified Guttman's offer of protectorate status and gladly joined the Archdiocese.

Kamchatka citizens grabbed this second chance with all their strength. In the next five years, they repaired all Brood damage returned to a positive production status. The Church of Odin sent thousands of followers to Kamchatka, pumping life into the moon throughout the rebuilding process.

Kamchatka's surface sees new life these days. All Sigurd pilots undergo survival training on the barren soil; pilots must survive on only emergency rations for a week. Naval command reports the survival rate at an all-time high of 89 percent. Those that don't make it weren't worthy of battle anyway.



## New Denmark

**System:** Apol

**Class:** Planet

**Natural Satellites:** Copenhagen

**State:** Sigurd Archdiocese

**Status:** Full member

**Autonomy:** Partial

**Environment:** Temperate

**Habitat:** Normal

**Gravity:** Normal

**Atmosphere:** Normal

**% H2O:** 42

**Mean Temp:** 00 lat: s 112 / w 64  
450 lat: s 89 / w 12

**Diameter:** 11,946 km

**Axial Tilt:** 49

**Day:** 28.7 hours

**Year:** 345 Days

**Danger:** None

**Race:** Ferran

**Population:** 11.4 billion

**Social Adaptations:** UV resistant genealogy

**Trade:** Technology

**Government:** Parliamentary monarchy

**Notes:** It's said that during years following the Brood invasion the people of New Denmark survived on will alone. Devastation on this planet reached every level of the population, environment and the economy. Brood hatchlings landed and spread to every corner of the planet. Deaths numbered in the billions. Less than seven percent of the New Denmark population survived.

But survive they did. Only the tough, the strong and the stubborn lived to see the Swarm's destruction. They rejoiced when Sigurd troopships drop out of the scarlet sky like angels of vengeance, eradicating planet-side Brood. Over 95 percent of the New Denmark survivors converted to Odinism in the next year.

This core group of converts guided reconstruction efforts over the next decade. New Denmark opened wide its doors to those left homeless by Brood savagery. This open immigration policy nearly overwhelmed governmental structure, and keeping up with demand for shelter, food and jobs remains a difficult task. Only in the last two years has the population appeared to level out. New Denmark, home to refugees from doz-

ens of systems, struggles to adapt to a vastly diverse population. Sigurd officials plan to return the planet to its pre-Brood stature by AL 20, but many see those plans as overly optimistic.

The main task facing government teams is keeping up with the vaccination and genealogical programming all immigrants must undergo. Health care was less than ideal for most Brood refugees and disease ran rampant throughout the Terran space. Immunizing all who wish to relocate to New Denmark is a necessity. Additionally, the harsh blue star of Apol sends out overwhelming amounts of UV radiation. All New Denmark citizens need genetic implants allowing them to generate proper amounts of natural protection. This procedure results in a distinct bluish tinge in human skin.

## Yak-Shindichi

**System:** Shindichi

**Class:** Planet

**Natural Satellites:** Rual-Yak, Roserro-Yak

**State:** Sigurd Archdiocese

**Status:** Full Member

**Autonomy:** Partial

**Environment:** Aquatic

**Habitat:** No natural habitat, dome cities on ocean floor

**Gravity:** 0.8

**Atmosphere:** Caustic, poisonous

**% H2O:** 07

**Mean Temp:** 00 lat: s 112 / w 68  
450 lat: s 32 / w 12

**Diameter:** 24,230 km

**Axial Tilt:** 174

**Day:** 64 hours

**Year:** 1,452 Days

**Danger:** Chaotic weather patterns

**Race:** Odinian

**Population:** 2.4 billion

**Social Adaptations:** Highly disciplined

**Trade:** Agricultural, mineral

**Government:** Parliamentary monarchy

**Notes:** The Shindichi system consists of seven planets, all lifeless rocks except for Yak-Shindichi. Strictly a scientific community, Yak-Shindichi grew to become House Shantac's capitol. Yak-Shindichi now serves the agricultural needs of the Archdiocese.

# The Next Millennium

“Hate Draconians?”

Heck no, I love ‘em. Look at my boots—only Draconian skin has that wonderful sheen.”

— Bora Peskovitch, Magni and member of Loki's Kids



# Silent Death

Yak-Shindichi is a world of incredibly violent weather patterns. Sulfur-laced water covers over 92 percent of the surface, and the atmosphere is so toxic it kills humans within 15 seconds. However, the seemingly inhospitable world houses a booming population on the ocean floors.

The Brood hovered around Yak-Shindichi for more than three months. Experts speculate that the Brood was formulating strategy and/or technology for attacking a population that rests over 2.5 miles underwater. Additionally, the planet's caustic atmosphere devastated Brood fighters. Many crashed without even a fight. These factors combined to delay a final assault; before that major offensive was launched Sigurd fighter wings demolished the Brood forces, liberating the planet from danger.

All cities are at least two miles underwater, where the daily typhoons have little effect. Yak-Shindichi reaps a bounty from the populous ocean floor. While the plants and animals are initially poisonous, they are also plentiful. The natives are highly adept at processing the harvest and removing all poisons.

## Yak-Tarull

**System:** Tarull

**Class:** Planet

**Natural Satellites:** Teoto-Yak, Poolik-Yak

**State:** Sigurd Archdiocese

**Status:** Full member

**Autonomy:** Partial

**Environment:** Lethal

**Habitat:** Sealed, floating cities

**Gravity:** 2.4

**Atmosphere:** Gaseous, poisonous

**% H2O:** 12

**Mean Temp:** 00 lat: s 312 / w 231

450 lat: s 199 / w 150

**Diameter:** 740,230 km

**Axial Tilt:** 75

**Day:** 261 hours

**Year:** 638 Days

**Danger:** Constant electrical storms

**Race:** Odinian

**Population:** 412 million

**Social Adaptations:** Highly disciplined

**Trade:** Chemical

**Government:** Parliamentary monarchy

**Notes:** The sprawling gas giant known as Yak-Tarull is rich in chemical wealth, its dense atmosphere and high gravity from rare compounds valuable on the galactic market. As can be expected in Terran space, where there is money there is civilization, regardless of the danger.

And danger exists in spades on Yak-Tarull. High temperatures, fierce electrical storms, gale-force winds, massive gravity, poisonous gasses and several atmospheres of pressure combine to make it one of the most inhospitable spots in Terran space. Inhospitable to most, but the adaptive technology of House Shantac allowed civilization to flourish. Like Yak-Shindichi, Yak-Tarull's cities are completely self-contained and protected from the deadly environment. The cities float through the soupy atmosphere, sucking in gasses and processing them for export.

Despite the relative safety of the cities, the convulsions of Yak-Tarull make for a dangerous existence. No city is allowed to grow a population in excess of one million. This provides stability by spreading people far and wide. The environment is so savage that any uncontrollable technical difficulty can quickly wipe out a city. There is almost no time to fix serious malfunctions. In the last 300 years 17 cities have plummeted towards the planet's core. Once a fall starts, it is only minutes before increasing atmospheric pressures crush the city like a champagne glass.

Like Yak-Shindichi, this hostile environment helped protect Yak-Tarull from the Brood. The corrosive atmosphere and electrical storms wreaked havoc with Brood fighters; they were barely able to stay aloft, let alone tangle with Yak-Tarull's heavily modified Spirit Riders. The outnumbered pilots racked up an amazing 22-1 kill ratio, keeping the Swarm at bay.

Experts theorize that the Brood had little interest in a gas planet, and merely wanted to destroy the population. The Spirit Riders stopped every Brood attack, resulting in a strategic stalemate. The Brood didn't have time to properly adapt to the situation before Sigurd forces arrived and demolished them.



## Agomio

**System:** Cetorix

**Class:** Planet

**Natural Satellites:** None

**State:** Sigurd Archdiocese

**Status:** Full member

**Autonomy:** Partial

**Environment:** Barren

**Habitat:** Normal, some sealed cities

**Gravity:** 1.0

**Atmosphere:** Normal

**% H2O:** 66

**Mean Temp:** 00 lat: s 98 / w 72  
450 lat: s 43 / w -10

**Diameter:** 7,985 km

**Axial Tilt:** 32

**Day:** 17 hours

**Year:** 285 Days

**Danger:** None

**Race:** Odinian

**Population:** 4.8 billion

**Social Adaptations:** Highly disciplined, survivalists

**Trade:** Agricultural, labor, industrial

**Government:** Parliamentary monarchy

**Notes:** While a member of the Ewanoma Cluster, Agomio functioned largely as a luxury planet. Vacationers flocked to its forests to gaze in wonder at the Rubyleaf trees and the Sparklemoss. The trees bear a uniquely translucent wood, which has been a sought after for exotic furniture for over 300 years. Agomio's economy flourished, but it produced little of true value.

That changed with the coming of the Sigurds. Swarm 701 ravaged the Ewanoma Cluster but left the agrarian Agomio largely untouched. With all its resources and work force intact, the Archdiocese quickly converted the planet for industrial tasks. Agomio's proximity to New Denmark and Kamchatka made it the logical center for the rebuilding of those planets. Now that Kamchatka and New Denmark's recoveries are nearly complete, Agomio's conversion to military production is well underway.

## Niflheim

**System:** Lol GW:213

**Class:** Planet

**Natural Satellites:** None

**State:** Sigurd Archdiocese

**Status:** Full member

**Autonomy:** Partial

**Environment:** Frigid

**Habitat:** Normal

**Gravity:** 1.2

**Atmosphere:** Normal

**% H2O:** 74

**Mean Temp:** 00 lat: s 47 / w -35  
450 lat: s 11 / w -62

**Diameter:** 10,835 km

**Axial Tilt:** 182

**Day:** 37 hours

**Year:** 513 Days

**Danger:** None

**Race:** Odinian

**Population:** 712 million Odinian, 194,000 Red Star

**Social Adaptations:** Highly disciplined

**Trade:** Mineral, military training

**Government:** Parliamentary monarchy

**Notes:** In the eyes of House Red Star's terraforming, Niflheim is an incomplete masterpiece. Once little more than a frigid rock with a pristine atmosphere, the Red Star engineers faced the task of raising the global temperature to life-sustaining levels, as well as introducing suitable plant and animal life. Their exceptional talents would have transformed Niflheim into a planet reminiscent of Earth — if the Sigurds had allowed the job to be finished.

Red Star terraformers raised the temperature over 100 degrees to current levels, but Sigurd officials stopped further increases. Red Star personnel wanted to give the planet a mean temp of 75 degrees. The Archdiocese, however, likes things cold and nearly inhospitable. To the Sigurds, the transformation is a masterpiece. Niflheim is comparable to Midgard in temperature and atmosphere, and much of Midgard's indigenous life flourishes on the new planet.

Niflheim's population is small but growing. The planet functions as garrison and training ground for the Sigurd ground forces. Over 200 million soldiers call Niflheim home. Army support ser-

# The Next Millennium

“When in doubt, shoot. Odin forgives aggressive mistakes.”

- Günther Guttman addressing the Tempering graduates of AL:11



# Silent Death

vices employ the remainder of the population. Niflheim's masterfully engineered cities make the planet little more than a massive military base.

Almost 200,000 Red Star personnel remain on the planet, finishing up the final stages of terraforming. The majority are employed in population maintenance, making sure that plant and animal life reach a harmonious equilibrium.

## Jbalerbru

**System:** Werrick 116  
**Class:** Planet  
**Natural Satellites:** None  
**State:** Sigurd Archdiocese  
**Status:** Full member  
**Autonomy:** Partial  
**Environment:** Under construction  
**Habitat:** Sealed cities  
**Gravity:** 9.7  
**Atmosphere:** Under construction  
**% H2O:** 18 and increasing  
**Mean Temp:** 00 lat: s 27 / w -12  
450 lat: s -26 / w -43  
**Diameter:** 22,230 km  
**Axial Tilt:** 15  
**Day:** 23 hours  
**Year:** 249 Days  
**Danger:** None  
**Race:** Odinian  
**Population:** 524 million Odinian, 1.2 million Red Star  
**Social Adaptations:** Highly disciplined  
**Trade:** Mineral  
**Government:** Parliamentary monarchy

**Notes:** Jbalerbru's terraforming remains in full swing despite tensions between House Red Star and the Archdiocese. The close proximity of the two peoples forges friendships; they largely ignore the conflict. Both cultures find more in common than different, and pray that war will never erupt between the two houses.

Jbalerbru's atmosphere is improving yearly. Red Star engineers hope to raise the oxygen level to life-supporting status by AL 18 at the latest. Populating the planet with higher plant and animal life begins in AL 20 and should be complete by AL 24 (population maintenance, of course, will continue for another 20 years).

## Jötunheim

**System:** Werrick 25  
**Class:** Planet  
**Natural Satellites:** None  
**State:** Sigurd Archdiocese  
**Status:** Protectorate  
**Autonomy:** None  
**Environment:** Normal  
**Habitat:** Normal  
**Gravity:** 0.7  
**Atmosphere:** Normal  
**% H2O:** 42  
**Mean Temp:** 00 lat: s 115 / w 76  
450 lat: s 82 / w 60  
**Diameter:** 5,902 km  
**Axial Tilt:** 114  
**Day:** 15 hours  
**Year:** 196 Days  
**Danger:** None  
**Race:** Odinian  
**Population:** 492 million  
**Social Adaptations:** Highly disciplined  
**Trade:** Infrastructure construction  
**Government:** Parliamentary monarchy

**Notes:** Sigurds consider Jötunheim a gift of the Gods. The tiny planet's temperature and atmosphere are perfect for human life. Small and out of the way, the planet remained un-colonized at the time the Swarm attacked. As such, the Brood completely ignored it. Seven years ago the Archdiocese opened the planet to 300,000 Pilgrims and charged them with the holy task of creating an infrastructure capable of supporting over 5 million people. The planet needs no terraforming, and as such the Archdiocese spends little on Jötunheim, which is self-sufficient. Officials can spare little in funds or resources and hope the Pilgrims can prepare the planet within the next decade. As reconstruction reaches the final stages on Kamchatka, New Denmark and Jbalerbru, more funding may be provided.

## Hvergglimir

**System:** Wasatch Gx091  
**Class:** Moon  
**Natural Satellites:** None  
**State:** Sigurd Archdiocese  
**Status:** Protectorate  
**Autonomy:** None  
**Environment:** Barren



**Habitat:** Normal  
**Gravity:** 1.8  
**Atmosphere:** Normal  
**% H2O:** 32  
**Mean Temp:** 00 lat: s 47 / w -12  
450 lat: s 33 / w -26  
**Diameter:** 9,372 km  
**Axial Tilt:** 215  
**Day:** 39 hours  
**Year:** 7,482 Days  
**Danger:** None  
**Race:** Odinian  
**Population:** 359 million  
**Social Adaptations:** Highly disciplined  
**Trade:** Infrastructure construction  
**Government:** Parliamentary monarchy

**Notes:** Hverggmlir is similar to Jötunheim; its small but dedicated population is preparing the planet for future growth. Hverggmlir's environment, however, is much harsher than Jötunheim's.

The Hverggmlir colony is a mere three years old, and Pilgrims continue to prepare for planet-wide construction. The building of factories and housing to support construction efforts is barely underway. It will be at least another five years before the Pilgrims move past bare essentials and begin constructing the planet's infrastructure. Like all planets except Midgard, Hverggmlir is wide open for human immigration.

## Panthalassa

**System:** Werrick 219  
**Class:** Planet  
**Natural Satellites:** None  
**State:** Sigurd Archdiocese  
**Status:** Protectorate  
**Autonomy:** None  
**Environment:** Barren  
**Habitat:** Sealed garrisons  
**Gravity:** 1.4  
**Atmosphere:** Sparse  
**% H2O:** 09  
**Mean Temp:** 00 lat: s 45 / w -02  
450 lat: s 30 / w -43  
**Diameter:** 32,195 km  
**Axial Tilt:** 64  
**Day:** 98 hours  
**Year:** 10,924 Days  
**Danger:** Frequent asteroid impacts  
**Race:** Odinian

**Population:** >100,000  
**Social Adaptations:** Highly disciplined  
**Trade:** None  
**Government:** Parliamentary monarchy

**Notes:** Panthalassa holds promise for the Archdiocese. The planet's land mass is expansive; the potential population could comfortably exist in the 100 billion range. Terraforming, however, requires at least 30 years before the planet is ready for unaided human life. The Archdiocese scrapped Red Star terraforming projects due to strained political relations. For now Panthalassa holds little more than a garrison on site to protect Sigurd interests. Planetary Defense Wing Pan-02, the Lizard Skinners, drills non-stop over Panthalassa's sparse skies.

## Laurentia

**System:** Werrick 314-J  
**Class:** Planet  
**Natural Satellites:** Toole, Lumin, Tankar  
**State:** Sigurd Archdiocese  
**Status:** Protectorate  
**Autonomy:** None  
**Environment:** Barren  
**Habitat:** Sealed garrisons  
**Gravity:** 0.8  
**Atmosphere:** None  
**% H2O:** 00  
**Mean Temp:** 00 lat: s -102 / w -232  
450 lat: s -241 / w -273  
**Diameter:** 12,003 km  
**Axial Tilt:** 49  
**Day:** 78 hours  
**Year:** 329 Days  
**Danger:** Frequent asteroid impacts  
**Race:** Odinian  
**Population:** >100,000  
**Social Adaptations:** Highly disciplined  
**Trade:** None  
**Government:** Parliamentary monarchy

**Notes:** Laurentia holds potential for the Archdiocese. A planet of ice, Laurentia will come alive with massive oceans if terraforming raises the mean temperature. The project began in AL 4 but was scrapped in AL 9 due to political strain between House Red Star and the Archdiocese. The only population is Planetary Defense Wing Lau-01, the Lonely Snowmen.

# The Next Millennium

“Ignorance of the law is no longer a defense. All members of the Archdiocese, not just citizens, shall learn the laws laid down by the Odin and the government. The prison system costs far too much, and that money is needed in the defense effort. Therefore, I have simplified sentencing. There are now two punishments; labor camps and death. Learn the laws and live by them or suffer the consequences. Consider yourself warned. The labor camps, by the way are full, which leaves us with only one punishment.”

- Günther Guttman in his AL:12 State of the House address



## Sigurd Terminology

**Beast-men:** Derogatory Sigurd slang name for the Primates. Beastmen are prophesied to join Loki's forces in the final battle of Ragnarök.

**Bifrost:** Heaviest class of Sigurd Gauss weaponry.

**Blue Bloods:** Slang term for residents of New Denmark.

**Citizen:** Only Citizens can vote in democratic affairs. The Archdiocese only grants citizenship to confirmed members of the Church of Odin. Non-Odinites are welcomed with open arms across the Archdiocese, but cannot to vote.

**Children of Muspell:** Sigurd derogatory term for members of the ASP Technocracy.

**Corpse-men:** Another derogatory name for the ASPers.

**Djevs:** High priest of the Sigurd Archdiocese. Roughly translates to "Sky Father."

**Draupnir:** Bishop of Sigurd Archdiocese. The highest official for each planet in the Archdiocese. The Draupnir works with

the planetary council to create local laws, provide services to citizens, improve the economy and implement all policies handed down by High Priest Guttman and Parliament. Several Draupnirs exist on Midgard as members of the High Council.

**Floater:** Slang term for Yak-Tarull residents. Also known as Dust Birds and Clouders (derogatory).

**Full Member:** This status conveys important rights to a planet.

**Gungnir:** Sigurd Gauss weapon system.

**Haas-Greebold:** Massive asteroid belt that has a long, elliptical orbit around Clesor, star of Midgard's system. The belt makes a close orbit pass around Clesor every 912 years. That orbit bombards Clesor's planets with asteroid damage. The belt is responsible for the destruction of the Midgard Consulate house in Imp 134.

**Hibernian Archdiocese:** Large Church of Odin splinter group that exists mainly on Hibernian Freehold worlds.

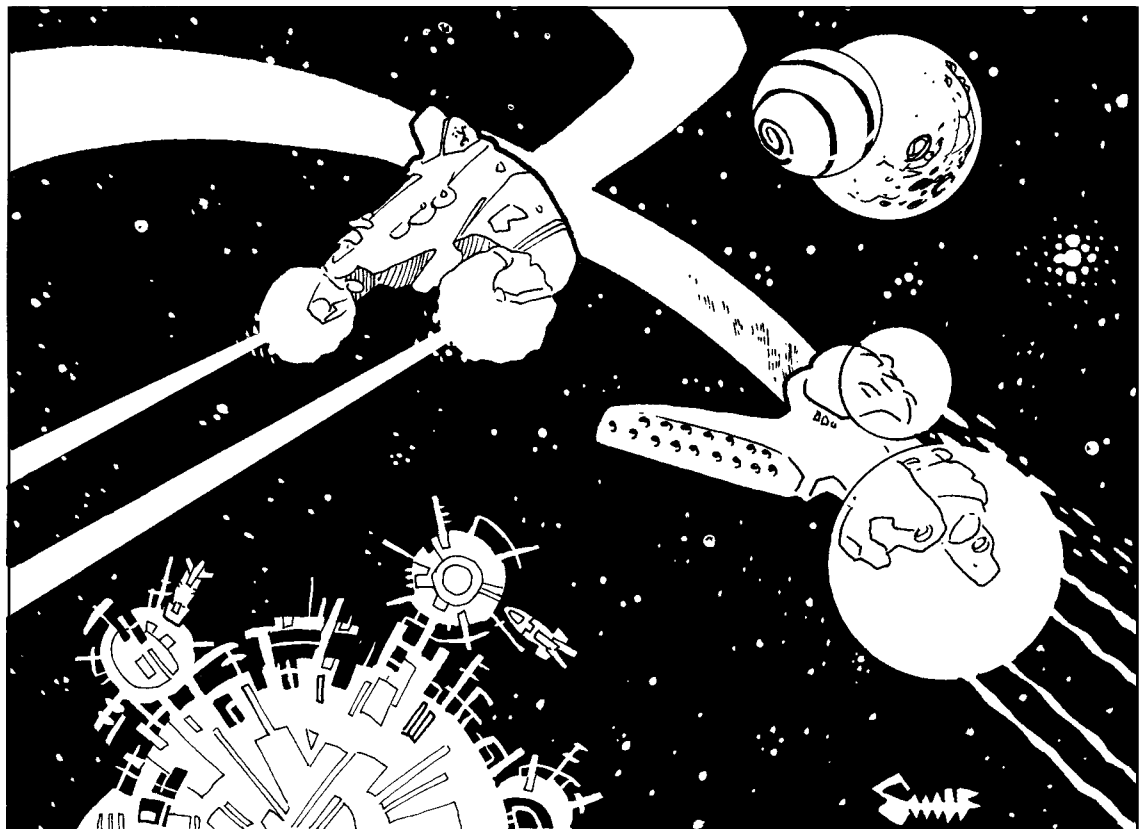

**High Council:** Cloister of Draupnirs that decide policy for the Church of Odin and the Sigurd Archdiocese.

**Huginn:** Sigurd warrior-priests of both the navy and army.

**Limpet:** Slang term for residents of Yak-Shindichi, who live their lives on the ocean floor.

**Lizards:** Draconians. Also: Snakes, Serpents, Scalies, Crawlers, Hissers and Boots-on-the-hoof (all derogatory).

**Nifler:** Slang term for Red Star citizens who live on Niflheim. Considered non-offensive by Sigurds, although most Red Star citizens find the name derogatory.

**Magni:** Sigurd Ace (five kills).

**Midgard Consulate:** Ancient house that originally ruled Midgard.

**Missionary:** A Sigurd pilot who takes his fighter to other systems, joining with other warriors and spreading the word of Odin

**Modi:** The Sigurd award for bravery in combat.

**Mjölfnir:** Sigurd basic Gauss weapon system.

**Mutumbe Day:** A national Sigurd holiday celebrating the life and honor of Dikembe Mutumbe, founder of the Yoko-Shan Warworld.

**Nagflar:** The mythical ship on which Loki will ride forth from Hel to attack Midgard. Also: a generic derogatory term for enemy Warhounds.

**Oarsman:** Crew of Sigurd warship.

**Off-World:** Anywhere in the galaxy except the Full Member planets.

**Paradise Archdiocese:** Free-wheeling Church of Odin off-shoot that exists mainly on Unkulunkulu Archipelago planets, but also has churches on other prime vacation planets across the universe.

**Parliament:** The governing body of the Archdiocese. Parliament runs all aspects of the government. Parliamentary decisions go before the High Council. Once

the High Council approves, Parliamentary decisions become law unless Guttman is interested in that particular affair, in which case he has the final, unquestioned word. Each planet elects one member of Parliament for every five million citizens.

**Participant Defense:** Policy of a two-year mandatory military service stint beginning on a resident's 18th birthday.

**Pilgrim:** Any Odinian in off-world service of the Archdiocese.

**Planetary Council:** The democratically elected body of officials that rule individual planets alongside with that world's Draupnir. Representation is by population only: each region elects one representative for every 100,000 citizens.

**Ragnarök:** The final battle between good and evil, where Loki's forces storm the gates of the mythical Midgard. Odinites believe this prophecy is coming true with the arrival of the Prometheans.

**Tempering:** Sigurd's unusual pilot graduation ceremony. Pilots are dropped off on Kamchatka's surface for one week and left with nothing but emergency rations. Temperatures often reach 250 degrees during the training period. Only those who survive are allowed to fly. This year he survival rate reached an all-time high of 92 percent.

**Tokuess:** The entertainment genre that celebrates House Tokugawa's victory against the Brood. Sigurds see the Tokugawan's transcendence from peaceful culture to warriors as a metaphor for life and the coming of Ragnarök.

**Víðarr:** Odinite terrorist group based in the Q'raj Void Protectorate.

**Viking:** Sigurd fighter pilot.

**War-cache:** Guttman knows the Odinites may soon stand alone in the battle of Ragnarök. The War-caches are massive stockpiles of food, supplies and ammunition.

# The Next Millennium





# Silent Death





# SIGURD ARCHDIOCESE™

*Guttman's battle orders boomed from the com units of the Sigurd Carrier Wing T-01 "Thor's Hammer." There was no sound of doubt or fear, only fury that the Brood would enter Midgard space. "Bach's Symphony, break to intercept the forward elements. Odin's Anvil proceed with me to primary targets. Make them pay with blood, no Brood survivors."*



# SIGURD™ ARCHDIOCESE

The Brood have swept through human domains like a vengeful plague and the Promethians hold sway over many of the Twelve. The faithful of the Church of Odin believe that only they can stand against these brutal foes and their evil encroachment on human space. Though some call the Midgardians fanatics, willing to throw their lives away for the visions of a madman, they know what is to come.

*Sigurd Archdiocese* shows the Church of Odin's rise to power in the Next Millennium and the rebirth of the church through the strength and charisma of Gunther Guttman.

*Sigurd Archdiocese* includes:

- 5 new Sigurd fighter displays
  - Hound
  - Hammer
  - Iceberg
  - Dagger
  - Storm
- 1 Sigurd escort
  - Longboat
- 4 Sigurd refit fighters
  - Pit Viper II
  - Glaive III
  - Spirit Rider III
  - Storm II
- 6 Scenarios staging 10 battles
- New Sigurd weaponry for fighters and escorts
- Church of Odin history and timeline
- Descriptions of Archdiocese fighter wings

**SILENT DEATH™**  
THE NEXT MILLENNIUM



Produced  
and distributed by:



ICE, Inc.  
P.O. Box 1605  
Charlottesville, VA 22902 USA

and  
distributed  
in the UK by:



HobbyGames LTD  
Unit S4, Rudford Industrial Estate,  
Ford Airfield, NR. Arundel,  
West Sussex, BN 18 OBD, U.K.

ICE 6.00

This specially-priced  
PDF is available  
through the ICE  
Online Store at  
[www.ironcrown.com](http://www.ironcrown.com)