

SILENT DEATH™

ANNEX



FIGHTER™

TACTICS MANUAL



**A training manual for
fighter combat in Silent Death**

Fighter Tactics Manual™

The Next
Millennium



Copyright © 1997 by
Iron Crown Enterprises.
All rights reserved.
No reproductions without
the express written
consent of **Iron Crown
Enterprises.** Produced and
distributed by **Iron Crown
Enterprises, Inc.,**
P.O. Box 1605,
Charlottesville, VA 22902.
Phone: (804) 295-4280.
Fax: (804) 977-4811.
Internet e-mail:
askice@aol.com
walsfeo@aol.com

Credits

Original System Design: Kevin Barrett
Fighter Tactics Authors: Sheldon Greaves,
Ph.D & Leland Erickson
Torpedo Essay: Bob Mohney
Cover Illustration: Quinton Hoover
Interior Illustrations: Glenn Angus
Miniatures Sculptor: Bob Naismith
Series Editor: Donald G. Dennis
Managing Art Direction: Jessica Ney-Grimm
Art Direction: Jason O. Hawkins
Assisting Art Direction: Donald G. Dennis
Pagemaking: Steven Arensberg,
Sherry Robinson
Cover Graphics: Wendy Frazer
Production Assistants: Ben Dooley,
John McMullen
Proofreading: Steven Arensberg,
Craig O'Brien
Ship Display Illustrations: Dan Cruger

ICE Staff:

CEO: Bruce Neidlinger;
President: Pete Fenlon;
Managing Editor: Coleman Charlton;
Sales Manager: Deane Begiebing;
Sales, Customer Service and Operations:
Becky Blanton, Arthur Brill, Steve Hardy,
Olivia Johnston, Dave Platnick,
Karina Swanberg, Monica Wilson;
Print Buying and Rights Director:
Kurt Fischer;
Editing, Production, and Development:
John Curtis, Donald G. Dennis,
Wendy Frazer, Jason Hawkins,
Bob Mohney, Nick Morawitz,
Jessica Ney-Grimm, Michael Reynolds;
Shipping and Receiving: Dave Morris,
Daniel Williams, Chad McCully.

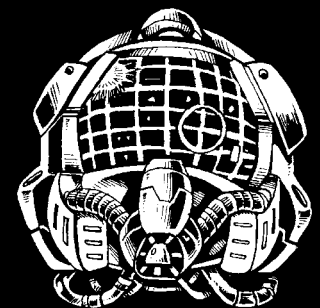

Silent Death

Playtesters:

Castle Archon:
 Jim Eisert, Andrew Thompson;
 Ottawa Redshirts:
 Richard Dufault, Glen Simpson, Scott MacGregor, George MacLure, Brad Hector, Michael Smith.
 Starbase 1: Paul Waite, Ian Deeks, Ollie Deacon, Trevor Jones, Phil Trott.
 APC: Alex Armstrong, Mike Zebrowski, Jesse Becker, Scott Crandall

Table of Contents

Introduction	3	Squadron Profiles	38
Four Basic Tactical Concepts	4	Sadroos Star Riders	38
Basic Concept 1: Superior Force Wins	4	Kali's Children	38
Buying Good Pilots and Gunners	5	The King's Messengers	39
Establishing "Local Superiority"	5	The Lynch Mob	40
Basic Concept 2: Teamwork Beats		Scenarios	42
Individual Heroics	6	Scenario 1: The Piranha Gambit	42
The Wingman System	6	Scenario 2: Catch As Catch Can!	43
The Diamond Formation	6	Scenario 3: Space Billiards!	45
The Finger Four	7	Answers to Exercises	46
Other Formations	8	Basic Tactical Concepts	46
Disrupting Formations	9	Weaponry	46
Basic Concept 3: Have a Plan	10	Situational Tactics	46
Planning for Disaster	10	Campaign Tactics	47
Planning for Lucky Breaks	11	For Further Reading	48
Basic Concept 4: Know Your Enemy!	12	Worksheets	50
Understanding Fighter Types	13	Helpful Aids Summary Chart	50
Gunboats	14	Fighter Designs	51
Learning by Experimentation	14	Bat	51
Basic Tactical Concept Exercises	14	Algol Systems A-117 "Stinger"	51
Weaponry	15	Herrera Consortium A-97 "Chupacabra"	52
Warheads - Missiles	15	Dionysia Dynamics P-401 "Shark"	52
Warheads - Torpedoes	15	Grivas Armaments EX-198 "Black Widow"	53
Evading Torpedoes	15	Homme Industries GBX-1 "Nemesis"	53
Evading Torpedoes Without Disrupting		Costs for Maneuverable and	
Your Formation	17	Variable Speed Torps	54
Attacking With Torpedoes	18		
Coordinating a Multiple-Ship Torpedo Attack	19		
Using Torpedo Spreads to Disrupt			
Enemy Formations	20		
Hiding Behind Your Torpedoes	20		
Cannon Fire	22		
Scoring a Hit, or, a Discrete			
Dissertation on Dice	22		
Combined Arms - Using a Mix of Weapons	25		
Don't Forget Your Tailgunner!	26		
Weaponry Exercises	27		
Situational Tactics	28		
Loss of Initiative	28		
Coping With Battle Damage	29		
Using Attrition Fighters	29		
Fun With Gunboats	30		
Using Gunboats	30		
Attacking Gunboats	30		
Fighting With Inferior Numbers	31		
Using Elite Forces	31		
Diversions, Traps, and Feigned Retreats	32		
Situational Tactics Exercises	32		
Campaign Tactics	33		
Assembling Your Flight Crews	34		
Building Squadrons That Work Together	35		
Choose Your Weapons	35		
Keeping the Mission in Mind	36		
Intelligence Gathering	36		
Campaign Tactics Exercises	37		

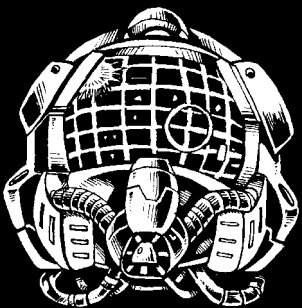

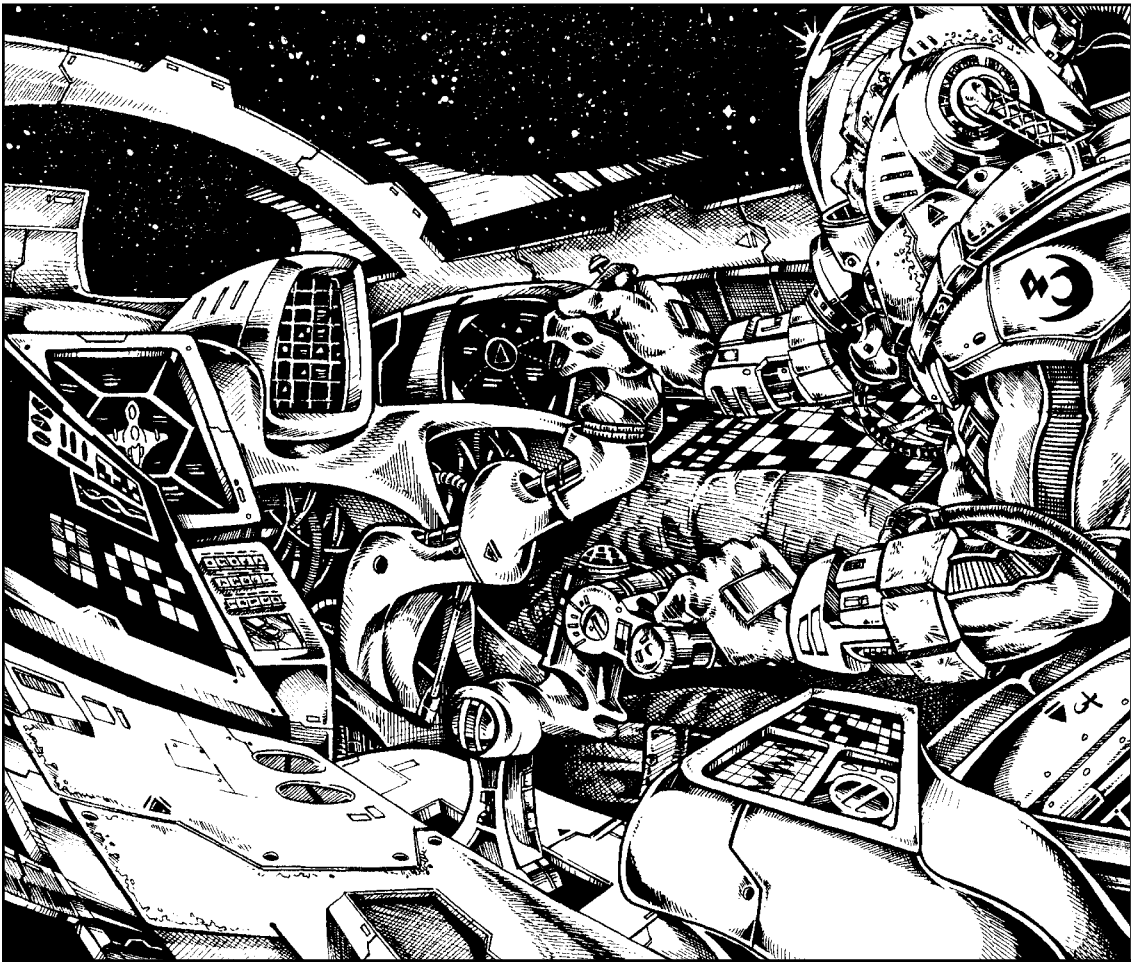

The Next Millennium

Fools Do Not Last Long

Warrant Officer Soohas Shah, 1134th Interceptor Wing, Kashmiri Commonwealth, rolled his Hellbender violently to port as he dodged a Colosian torpedo that was closing fast on his ship. The Colosians in this sector were trade rivals of the Commonwealth for the lucrative Icegem trade. What had been a peaceful, if mutually wary and tense, trade competition for nearly a year had turned violent within the last 25 Standard Hours. A Colosian attack group, attempting to pass themselves off as

Introduction

“Nothing so comforts the military mind as the maxim of a great but dead general.”

—Barbara W. Tuchman

This manual discusses some principles and techniques designed to improve your play at the gaming table. In researching what you are about to read, we drew a lot of inspiration from the experience of real-life fighter pilots, and history’s great strategic thinkers. Many of the same factors that contributed to victory in historic air battles can strengthen your play on the gaming table.

If you’ve played *Silent Death* before, this book is for you. Whether you’re a newcomer or a seasoned veteran, especially if you’ve been soundly thrashed a few times, chances are you will learn something from this book. If nothing else, this book can help cut your losses or salvage a situation on those days when Lady Luck turns out to be AWOL.

Except where we note otherwise, this manual will assume that only the basic rules are in play. If you use optional rules, you will have to allow for the resulting changes in the tactics of the game. Some of the things we suggest will not work in the same way. If you are new to *Silent Death*, or if you do not have a working knowledge of the basic rules, purchase and review a copy of the *Silent Death: The Next Millennium* rulebook until you are thoroughly familiar with it. Play a few solitaire games to make sure you understand the different phases in a turn and know the rules well enough that you do not have to look something up every other minute. Just knowing the rules can improve your play by reducing confusion and distractions.

We do not guarantee that you will always win if you study this book, but you will probably win more often, and when you lose, you will not lose as badly. Most im-

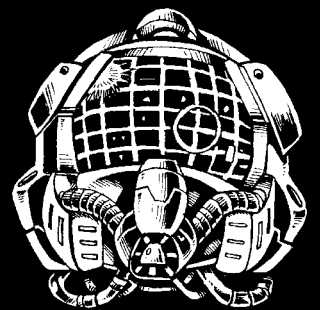

Silent Death

pirates, attacked what they thought was a lightly defended Commonwealth freighter only to discover that they had picked a fight with a Commonwealth Q-ship carrier. After some persuasion the surviving Colosians had become very talkative indeed.

Now, it was the Commonwealth's turn to employ a little "hard sell" of their own, which was why Soohas and his squadronmates were engaged in a swirling brawl around a critical Colosian refueling station.

Soohas spotted Raji, one of his squadronmates in a damaged

portantly, you will learn to understand why you goofed, and avoid those mistakes next time.

You will notice that we have scattered some favorite quotations from some of history's most profound military thinkers throughout this book. We do not expect you to memorize them as you would the rules of this game. We intentionally included some quotes that disagree with each other. We did this in order to get you to think about strat-

egy and tactics, and develop your own ideas. Remember, no school of tactical thinking will have all the answers, and tacticians who claim to have them eventually get a rude awakening. It's just a matter of time. If you use what we present here to create a unique, effective style of play, then this book will have served its purpose.

Good Hunting!

Sheldon Greaves

Leland Erickson

Four Basic Tactical Concepts

Fas est et ab hoste doceri.

("It is right to be taught, even by an enemy.")

—Ovid, *Metamorphoses*, iv, 8 AD

Silent Death is a fast-paced, action-filled game where a lot can happen in a few turns. The game is designed to reward aggressive play. Newcomers soon learn, however, that there is a fine line between "aggressive" and "reckless." Fighting hard is no substitute for aggression directed by careful planning and skillful execution. Throughout each game you need to constantly examine the advantages and disadvantages, the strengths and weaknesses of the forces in play. When you're sizing up the situation, here are some things to ask yourself:

- Who has better formation integrity?
- Who has the higher levels of pilot and/or gunnery skill?
- Who is faster?
- Who is easier to hit?
- Who can take more punishment?
- Which side has weapons that reach further?
- Which side can do more damage per hit?
- What positional advantages exist, and who has them?

As you ponder these questions during a game, you will see opportunities and problems. The basic tactical concepts that follow will help you make the best use of your forces. These concepts are:

- Superior force wins.
- Teamwork beats individual heroics.
- Planning pays.
- Know your enemy.

The next sections explain these concepts in greater detail.

Basic Concept I: Superior Force Wins

"The more you sweat in peace, the less you bleed in war."

—Chinese proverb

Sound combat tactics make the difference between victory and defeat. Most winning tactics involve attacking your opponent's weaknesses with your strengths. Ultimately, most successful tactics come down to three simple words: superior force wins.

"Superiority" comes in many forms. "Superior force" is not just numerical superiority; one fully-loaded Salamander is a good match for three or four Pit Vipers. A gunner with a skill level of 9 is likely to score more hits than two gunners with skill levels of 2. A small group of fighters working as a team can outfight a similar or even a larger group that tries to dogfight as individuals.

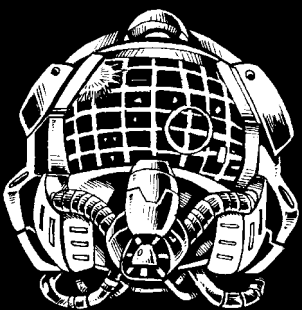

Buying Good Pilots and Gunners

“To lead an untrained people to war is to throw them away.”

—Confucius, Analects, xiii, c. 500 BC

One quick way to improve your chances of success is to use high-quality pilots and gunners. Do not skimp on skill. If you have the option to do so, spend the points and get the very best! Since gunners fire before pilots, if you have to cut corners, spend more on gunners than on pilot gunnery skill, and keep the piloting skill as high as possible. How good is “good enough”? If you’re worried about dodging torpedoes, piloting skill should be as high as you can afford. If you’re more concerned about tight turn costs or getting the highest possible Attack Die Bonus, a piloting skill of 7 is enough for a D4 on tight turns. A gunnery skill of 9 is the minimum necessary to get a D10 ADB.

Establishing “Local Superiority”

“A general-in-chief should ask himself frequently in the day, ‘What would I do if the enemy’s army appeared now in my front, or on my right, or my left?’

If he has any difficulty in answering these questions, his position is bad, and he should seek to remedy it.”

—Napoleon Bonaparte,
Maxims of War, 1831

History is filled with examples where superior tactics and training allowed smaller fighting forces overcome larger ones. During the Battle of Britain in World War II the smaller Royal Air Force used radar and intercepted German communiqués to concentrate their fewer planes where they could do the most damage to the Luftwaffe. The British created small zones where they held “local superiority,” inflicting losses that gradually added up. Likewise, the tiny Finnish Air Force achieved startling kill ratios as high as 32

to 1 against their larger, better equipped Soviet adversaries. The Finns, however, had a strong advantage in smart combat tactics and incomparable pilot training.

Establishing zones where you have local superiority is key to dominating the game. There are many, many different ways to accomplish this, some of which are listed below. The rest of this manual will develop these and other ideas in greater detail, explain ways to use them, and give you a chance to experiment with how they work. A few ways to gain local superiority are:

- Superior pilot/gunner vs. inferior pilot/gunner
- Firepower directed at a target frontage with no return-fire capability
- Attacking so as to avoid enemy supporting fire
- Using long-range fire if it exceeds the longest range weapons of your opponent
- Splitting or scattering a fighter group, or separating a gunboat or frigate from its escorts
- Ganging up on stray craft
- Deploying your forces so that any craft that gets attacked will be set upon by another ship
- Winning initiative in an otherwise even fight
- An ambush (if the rules in use allow for it)
- Timing torpedoes from multiple fighters so they impact a common target at the same time getting maximum effect for minimum effort

The common thread in most of these ideas is that you do everything you can to overwhelm the defenses that are directly under attack. If two fighters gang up on one fighter instead of going one-on-one with two other fighters, one enemy fighter will be unscathed, but chances are it will have to face 1:2 odds next turn. Find the weakness, hit it as hard as you can, and you will gain an advantage. Remember: Superior Force Wins!

The Next Millennium

Lance Electra attempting to disengage from the fight. Raji had just added a new docking port to the refueling station by planting a spread of protobolts into one of the stations storage fuel cells. “Very colorful!” thought Soohas.

The Lance Electra was in trouble; damaged, her power curve flattening, and out of everything but a Pulse Laser, having lost his wingman. Now Raji had gained the unwelcome attention of a lone Colosian Thunder Bird. Soohas signaled his wingman, Sadroo, the two Commonwealth Hell Benders turned hard over and

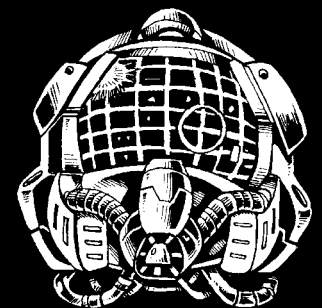

Silent Death

raced in to the aid of their damaged comrade, Soohas mentally calculated the relative velocities and distances between the Colosian and Commonwealth fighters.

Soohas and Sadroo closed the gap rapidly as Soohas gave the pilot damaged Electra very specific course change instructions. The Colosian pilot was keenly intent on his intended prey.

As the Colosian pilot was about to fire on a seemingly helpless Electra the wounded prey turned away from the head-on confrontation and the dumb-founded Colosian found himself face to

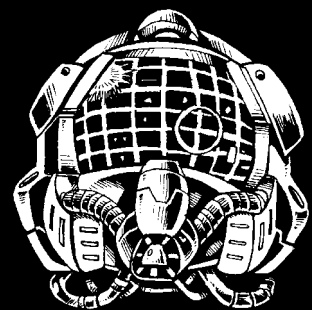

Basic Concept 2: Teamwork Beats Individual Heroics

“Weigh the situation, then move.”

—Sun Tzu, *The Art of War*, vii

The Wingman System

*“He who advances is sure of Heaven,
But he who retreats will suffer Hell.”*

—common slogan of Ikko Ikki
banners Japan. circa
1480-1580 AD

Fighter pilots in World War I began by dueling each other in single combat, like Homeric warriors or feudal knights. But as the war progressed, pilots discovered that they were more effective when they fought as a group. As a result of these experiences some air forces divided their squadrons into pairs, a “leader” and his “wingman.” A leader/wingman pair is called an “element.” The wingman keeps enemy fighters from getting a clear shot at the leader while the leader attacks. If an enemy plane tries to draw a bead on the leader, the wingman chases it off. Ideally, fighters are arranged so that anyone who attacks one ship will come under fire by another ship. As you evaluate each move, you should plan for “mutual support.” If a vulnerable side of one of your fighters is in the firing arc of another one of your fighters, that fighter has mutual support. An enemy that tries to hit that vulnerability will get shot at.

We recommend two main formation styles in this manual, although there are certainly others worth trying. Both consist of four fighters. Formations with more than four tend to be harder to maneuver smoothly. These two formations are the Diamond (left) and the Finger Four (right).

The Diamond Formation

“The Romans are sure of victory... for their exercises are battles without bloodshed, and their battles bloody exercises.”

—Flavius Josephus, 37-100 AD

This formation consists of four fighters, two in tandem, with one on either side of the central pair. This formation keeps its integrity quite well, even when you have to change hex facings. You cannot always keep the same fighter in the lead, but this should not matter much. In fact, it may actually work to your advantage. Since lead fighters tend to be damaged first, alternating the lead position spreads the damage around. A little damage on several ships is better than all the damage on one.

If you want to move your formation through one or two standard turns, you need to make sure you have enough drive points to see the maneuvers through. Here is a method to help you estimate how far you can push your formation. If the ship on the outside of the turn can make it to your designated goal, the formation as a whole can make it as well.

FORMATION EXAMPLES

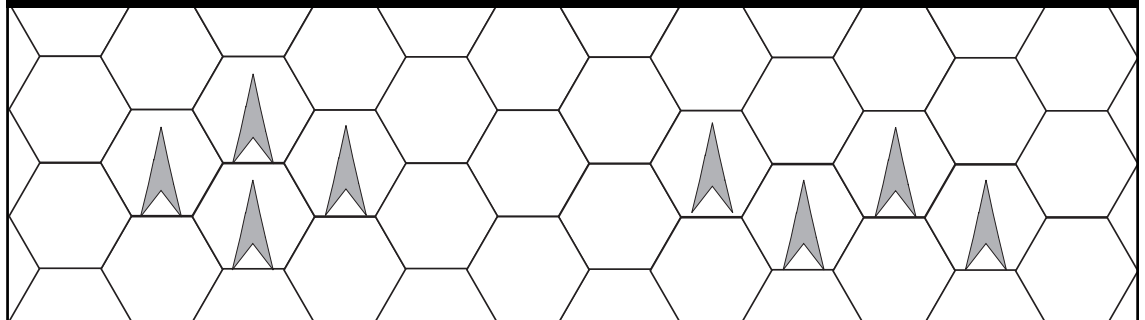

The ship on the inside of the turn will require two points less than the outside ship.

Of course, this assumes all the ships in the formation have the same drive. Ships that are slower than the others in the formation, whether by damage or design, can move to the inside position if you are planning a turn in a particular direction.

In most situations, the Diamond maneuvers more easily than the Finger Four. As you can see from the diagram below, it also provides the best concentration of cannon fire to the forward arcs and rearward arcs where applicable. This formation is less satisfactory for evading certain kinds of torpedo attacks, which we will discuss below in the section on torpedoes.

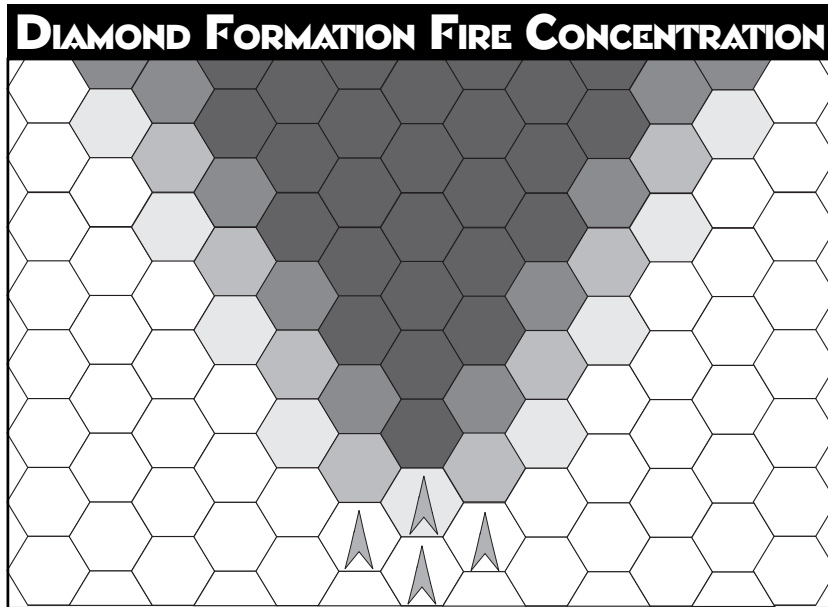

The Finger Four

“Untutored courage is useless in the face of educated bullets.”

—George S. Patton, Jr. in Cavalry Journal, April 1922

The Finger Four is simply a row of four fighters side by side and facing the same direction. This formation does not corner very

well, but you can change direction slightly by sideslipping if you use the optional sideslipping rule. The Finger Four also tends to spread the firepower more than the Diamond. Although this formation is less efficient at concentrating fire in close attacks against specific targets, it is better for evading group torpedo attacks, especially if the sideslipping

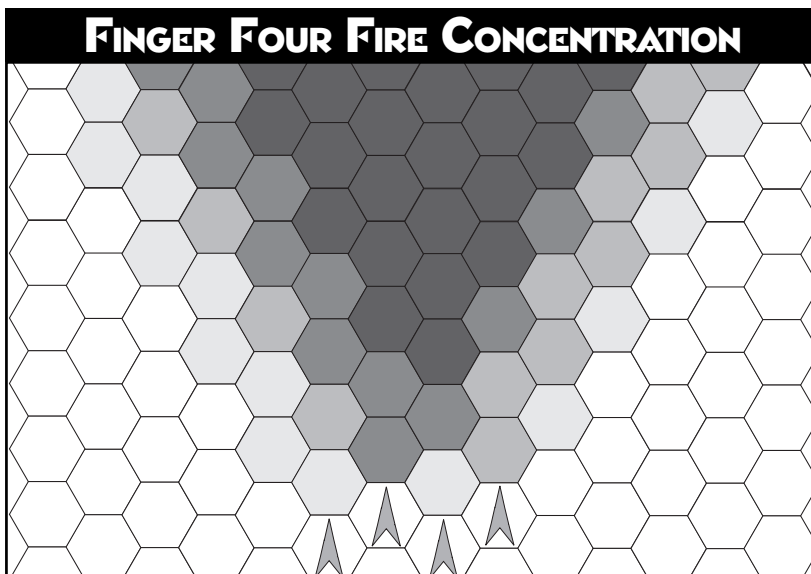

The Next Millennium

face with a pair of undamaged Hell Benders. “Ooh, Thank you!!” shouted Soohas as he thumbed the fire control stud and watched the Colosian ship go to pieces in a flash of fire and debris.

As Soohas and his wingman turned back to assist their squadron mates, Soohas reflected on something an old guru had once said to him; “A fool and his life are soon parted...”

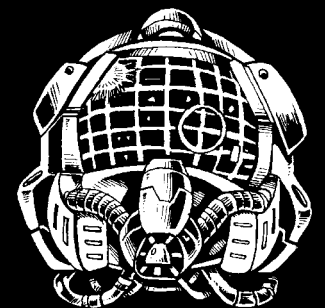

Silent Death

Childhood Fantasies

Ilmarii snapped his Kosmos in a last second maneuver designed to take him and his wingman, Haaviko, out of the firing arc of a Colosian Nighthawk that had vectored in on them.

“Nighthawks! Why the Hell did it have to be Nighthawks?!” snarled Ilmarii. That was the third one in as many seconds that had tried to swat the pair of desperately maneuvering. It wouldn’t be so bad if they were not out of ammo and low on fuel.

“One more bandit at pointzero-six-niner!” shouted Haaviko in warning, “It’s a Hellbender!”

rule is in play. The Finger Four is also a good formation if you are lying in wait for enemy ships heading into your field of fire.

Despite the slightly wider collective field of fire, the Finger Four is very intimidating. One interesting feature of the Finger Four’s “kill zone” (see diagram) is that the maximum concentration of firepower starts on the third hex away from the formation. Keep this in mind when you use this formation in an attack.

Other Formations

“It is better to lose a province than split the forces with which one seeks victory.”

—Frederick The Great

During World War I allied aircraft would sometimes adopt a defensive formation that came to be known as the “Lufbery Circle,” named for Raoul Lufbery, an American volunteer pilot who flew with the Lafayette Escadrille. Essentially, the Lufbery Circle is a formation in which fighters fly in a circle so that each fighter can cover the rear quarter of the fighter ahead of him, making it harder for an enemy to attack any one fighter from behind. Fighters in this formation could hold position until help arrived, or they could gradually circle towards their own lines.

This tactic is also useful in a *Silent Death* conflict, especially as a way to deal with larger numbers of fighters. The diagram below shows a simple Lufbery Circle made with three fighters. To illustrate how the mutually supporting fields of fire work, the forward firing arcs for the top and bottom fighters only are shown in gray and light gray respectively.

Notice that there is a “free zone” off the Left Front arc of the topmost fighter. Obviously, the Lufbery Circle isn’t an airtight defense, but your opponent may not look for the positions from which to take a free shot. This formation is far less dangerous with more than three fighters. Six fighters in the circle lets you achieve a tighter defense with overlapping fields of fire. Another way to stiffen this formation would be to put a ship in the center of the circle that had a weapon or weapons with a 360° field of fire, or point the ship so that its weapons covered vulnerable zones.

One of the reasons for using formations in the early days of air combat was the fact that most fighters had their armaments facing forward only. You could only cover your buddy if you happened to be facing the right direction. But several ships in *Silent Death* have weapons that cover a full 360°. You might think that you can open the formation up a bit, or dispense with it entirely!

Not so fast, Cadet! Take the Lance Electra as an example. These ships carry missile launchers that can fire 360°. Missiles have an effective range of ten hexes, so you might think that as long as each ship stays within ten hexes of another ship, you’re covered. So you string out three Electras in a longer line, the first one seven hexes from the second, and the second one seven hexes from the third. The ships are well within the missile ranges of each other, so it seems everybody’s covered.

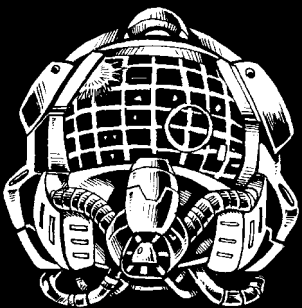
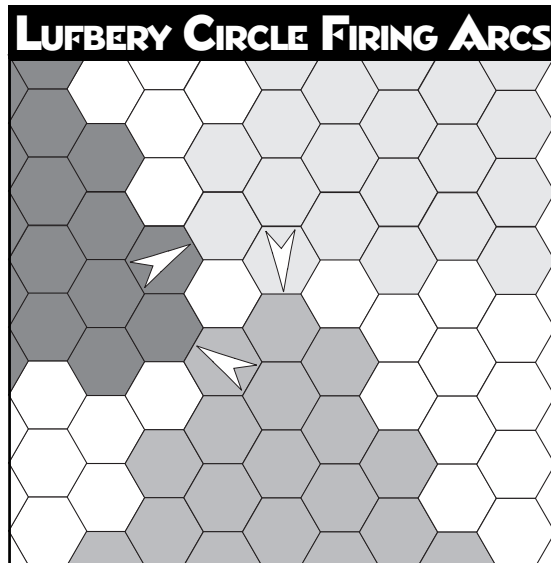

Suppose someone manages to knock out that middle ship? Suddenly ships One and Three are fourteen hexes apart! Their missiles will not cover each other. Chances are, their protobolt projectors are pointed the wrong direction. The best you can do is to spend a turn getting your ships back where

they can support each other. If your opponent moves quickly, he can gang up on one of them, and have it over a slow fire before you can say “barbecue sauce.” Remember: Never leave your ships without mutual support.

The Next Millennium

360° MISSILE COVERAGE EXAMPLE

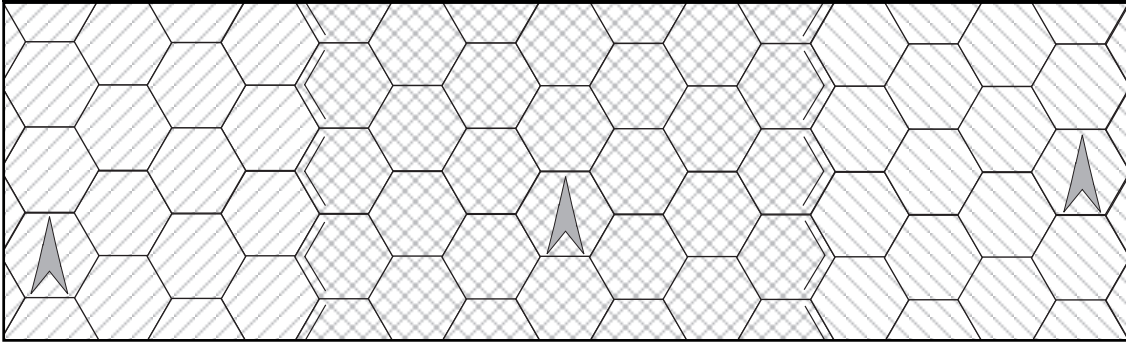

Disrupting Formations

“Move upon your enemy in one mass on one line so that when brought to battle you shall outnumber him, and from such a direction that you compromise him.”

—Napoleon Bonaparte

When you and your opponent are alternating moves, sometimes you will get the opportunity to break up your opponent’s formation by simply getting in the way. When an enemy formation is moving ship by ship, put one of your ships (a small formation is even better) in a spot where an enemy ship would want to be to maintain formation. Not every situation lends itself to this kind of tactic. The idea situation is if you have a formation of slow ships trying to move a long distance over several turns. A few point spent to move around a few fighters would be far less costly to a Teal Hawl than a Betafortress.

Attrition fighters are wonderful for this because they usually have the numerical advantage needed to bring this off smoothly. They also have fairly high defen-

sive values, which is important because the ship that first drives the wedge is likely to get hit from at least two sides. Another good choice is any fighter with a tail gunner. This lets you take shots at the ship you are prying out of the formation, and its closest squadron mate. By “driving a wedge” of more and more of your ships between opposing ships, the enemy ships gradually get swept apart, and thus become vulnerable to isolation and piecemeal dismemberment. Meanwhile your wedge remains more or less cohesive, able to direct its fire at either the solitary ship or the weakened enemy formation. Doing this against regular fighters is less effective than against slow gunboats, as they have an easier time getting around a wedge. Unless you have massive numerical superiority, it will be easier to pry one ship from the enemy formation at a time. Isolate, close, then destroy. We call this maneuver “The Greaves Wedgie.”

“Turn two-zero-two! Now!” shouted Ilmarii.

The two beleaguered Karelian pilots executed a sudden snap roll maneuver worthy of any acrobatic team, leaving a frustrated Colosian pilot to spit out his opinion of the Karelians and their tactics. The two Kosmos streaked toward the safety of their own space.

“Seven-Seven-niner! Two Blizzards and they aren’t ours!” came Haaviko’s warning.

“We’re in for it now!” Growled Ilmari. “We’re going to have to do some head-butting with these two!”

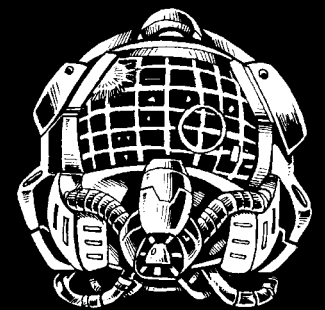

Silent Death

The two Karelian pilots punched their thrusters and rocketed head on at their tormentors, Ilmari thought to himself, “I never would have guessed when I was a kid that being a grown-up could be so much fun!”

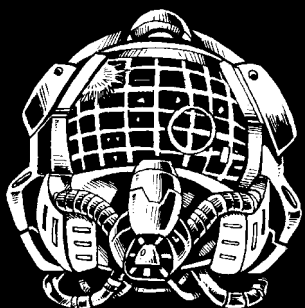
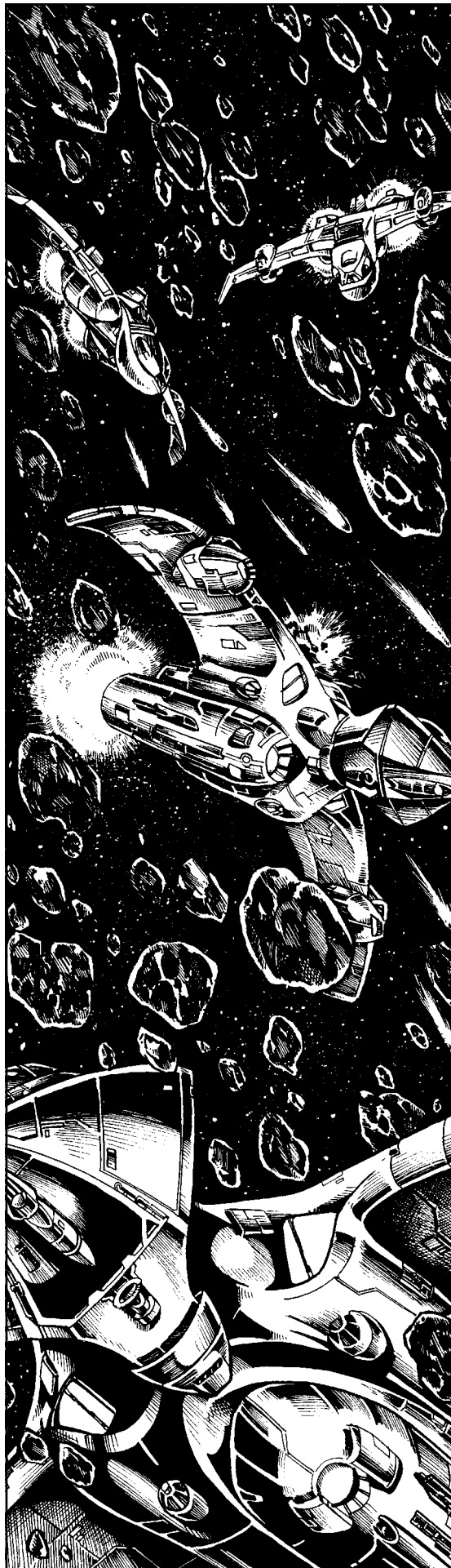

Basic Concept 3: Have a Plan

“If the trumpet give an uncertain sound, who shall prepare himself to battle?”

—I Corinthians 14:8

Old soldiers are fond of saying “No battle plan survives first contact with the enemy.” You might think that you should not put too much planning into how you will play your next game, but you should. The best way to plan your approach to a situation is not to have a foolproof plan. Instead, always have contingency plans.

Planning for Disaster

“The art of war is divided between force and stratagem. What cannot be done by force must be done by stratagem.”

—Frederick the Great, Instructions for His Generals, xii, 1747

What makes a good battle plan? Simplicity helps. If your play depends on too many chance factors or too many die rolls going your way, the plan will not work. Your plan depends on your mission. What exactly are you trying to do? Block a convoy? Intercept a courier ship? Clear a minefield? Create a diversion? Destroy as many enemy ships as possible? Escape with something resembling a whole skin? Lay your plans accordingly. In some scenarios, the victory conditions may allow more than one option for completing the mission. Your orders might be to destroy the cargo ships in the convoy, but if you manage to capture them, the Brass upstairs will be happier. In cases where there are optional victory conditions, pick the easiest one and do not pay any attention to accusations of cowardice from those yahoos across the table. The idea is to win.

If there’s an easier way to win, take it. If you are creating scenarios for other players, keep this in mind. Do not give them too many optional victory conditions, and do not make the “easy” solution too easy—or too obvious.

Many of the points in this manual will help you decide how to carry out your goals. One question you may have is, "Who do I attack first?" As a general rule, direct as much force as possible against whatever poses the greatest threat to the completion of your mission. Larger, heavier ships deserve close attention early on, because their heavier weapons can knock down the damage reduction (and a lot of other things!) of any lighter ship they hit. Once damage reduction has been taken down, a ship is more vulnerable to lighter weapons that otherwise might not get much damage through. A ship's speed is another crucial factor. If you can bring the drive of any fighter below 10, that ship can no longer dodge torpedoes. Hit the target with enough missiles or massed cannon fire to slow it down, throw a bunch of torpedoes at it to give it a hobby, and move on.

Sometimes the primary enemy threat is not any one or two major ships, but a formation of smaller ships. Ships almost always fight better in groups, so you should give some consideration to breaking up the enemy formations. Torpedoes are a good way to do this, as are feints and diversions. One danger is that if you try to outflank your opponent or dangle an inviting diversionary target as bait, you must often break or loosen your own formation.

If you do this, be careful. Make sure your plan includes a provision for reassembling your forces, preferably at a critical moment where they can concentrate their firepower where it's needed most.

Seeing the greatest threat depends in part on your own forces. If you are flying Teal Hawks, an Ion Ram is not a problem until your drive gets reduced. Think in terms of what can hurt you the most at the present moment. In addition there is the question of mission completion. If you only need to destroy a specific target and withdraw, this will affect the amount of time you spend in contact with the enemy. If you only need three turns to complete your objective, and the really dangerous weaponry needs four turns to catch you, it's not a serious threat.

How and when do you adjust your plan? Minor adjustments will be needed throughout as ships get hit or your opponent makes unexpected changes and responses to your moves. In other words, you have to make adjustments to match the flow of the game. Ironically, serious changes in your plan may be needed when you are very close to victory or defeat.

A change or adjustment in a plan can break an impasse and swing momentum in your direction. If you see your opponent's forces wavering, adjust your plan to strike hard right then at the weak point. If you're in trouble, you need to shore up your position in whatever way best serves the needs of your mission. Be careful not to over-commit your forces. Try to retain some extra assets to commit at the pivotal moment. Many of history's great commanders kept their very best forces in reserve until the crucial moment, then unleashed them on their harried, disordered opponents for the breakthrough.

Not every opportunity to take the advantage will be obvious. Sometimes you have to nudge opportunity a little, sometimes you have to kick its door down. Look for opportunities. During each move, ask yourself:

- Am I attacking the enemy's weak spot?
- Does this move help me concentrate firepower on the target?
- Can my ships support each other?
- Can an enemy attack me without taking return fire?
- Are any torpedoes tracking this ship? If so, where are they?
- Does this move improve or degrade my previous position?

Planning for Lucky Breaks

"In planning, never a useless move; in strategy, no step taken in vain."

—Ch'en Hao, 8th century AD

When most tacticians plan a move, they do so with an eye towards what can go wrong. That's just being realistic. But sometimes it's a good idea to plan for lucky breaks. In other

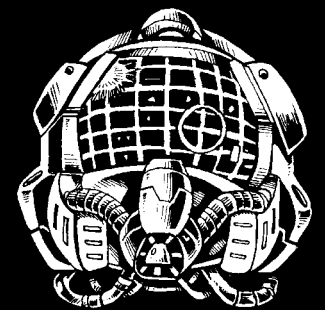

Silent Death

words, set up your moves so that you can take advantage if you get very lucky, or your opponent gets very unlucky, depending on your point of view. Consider the situation below:

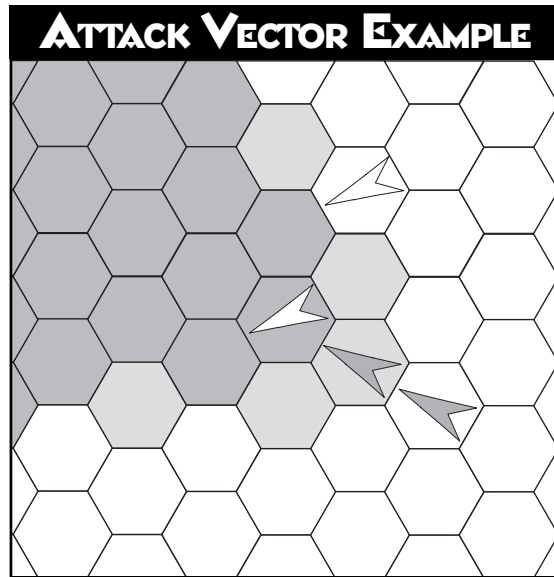

The gray fighters are on an excellent attack vector against white. Their fire is concentrated on a single ship. Unless the white ships have weapons that can cover the side arcs, the gray ships will not take return fire. But suppose the dice give Gray a real present: suppose that the first shot comes up big enough to score a critical hit on the target. Further suppose that the crit results in a dead pilot or a blown reactor core. The good news is that Gray is up by one ship. The bad news is that the second Gray ship no longer has a meaningful target in range.

Here is an improved variation on Gray's attack:

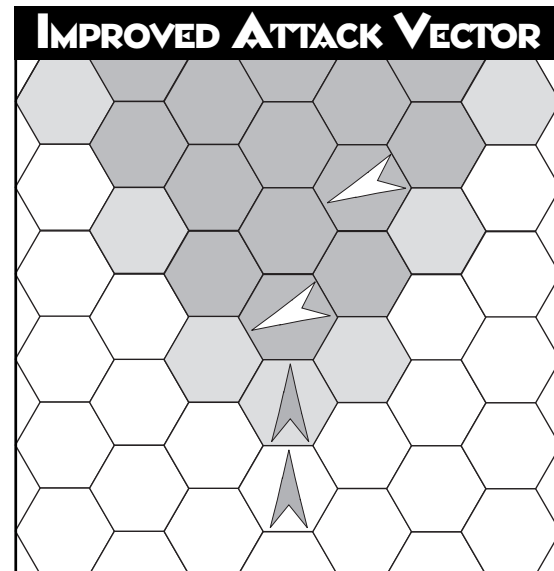

Gray is still concentrating firepower from both ships on a single enemy fighter. Again, both gray ships are outside the reach of return fire from the forward arc. But this time, if the first gray ship hits the target hard enough to destroy it or render it meaningless, there is still an alternate target for the second gray fighter. Getting this kind of luck is an unusual and welcome thing. No player should rely on this kind of thing happening very often, but a good player knows how to maximize those rare streaks of extraordinary good luck. Once in awhile, even you will get really lucky. Plan for it.

Basic Concept 4: Know Your Enemy!

"Tis best to weigh The Enemy more mighty than he seems."

—Shakespeare, King Henry V, ii, 4.1598

When you aren't gaming, go through the rules and look carefully at the ships. You will find it to be a very good investment of your time. Look at obvious things like drive, how many weapons and what kinds of weapons are available, the presence or absence of a gunner, and so on. But do not forget to pay attention to things like frontages without a weapon, or a critical hit early in the damage track. Carefully examine the critical hit options for each ship. Is it possible to kill or merely daze the gunner? How many damage points do you have to inflict before the fighter is too slow to dodge torpedoes? How many before all of the ship's weapons are destroyed? All of these things should be part of your thinking as you prepare your short and long-term battle plans.

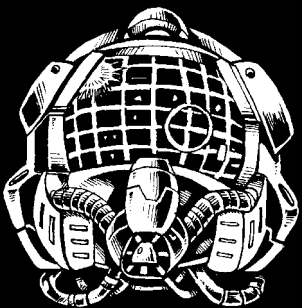

Understanding Fighter Types

“A general is not easily overcome who can form a true judgement of his own and the enemy’s forces.”

—Vegetius, *De Re Militari*, 378, Weaponry

This is a good a time to talk about how fighters are designed. There is no such thing as a truly all-purpose fighter. What is remarkably successful in one role can be dismal in another. This is why there are different kinds of ships. They are set up to deal with different situations, command dispositions, and goals. Understanding the various classes of fighters will help you chose the right ship for a particular mission. It also helps you see when your opponent makes a bad choice and thereby plan for his upcoming defeat.

There are five basic types of fighter in the *Silent Death* universe: Attrition, Strike, Superiority, Multi-mission, and Heavy. Some individual designs overlap and can be used in more than one role. Gunboats are not fighters. Their role is different, and we consider them separately.

Attrition — These are small, fast, cheap fighters best used in large numbers. Their advantage is that they are usually harder to hit. Their disadvantage is that a roll that’s high enough to hit is also high enough to hurt. They lose much of their effectiveness after taking a moderate swat. Attrition fighters work by inflicting a lot of small hits that gradually add up. At the same time, attrition fighters usually take higher losses than other types. The object is to spend a few cheap fighters and crews in order to destroy more expensive, harder-to-replace targets. Examples of attrition fighters include the Pit Viper, Dart, Talon, Blizzard, or Spirit Rider.

Strike — This class consists of ships that are designed to hit hard and get out fast. Many of these use expendable ammunition, so they are less effective in extended engagements with attrition or superior-

ity fighters. Strike fighters are a good choice for attacking larger ships or in hit-and-run scenarios. Strike fighters include the Lance Electra, Thunderbird, Kosmos, and Hellbender. The Blizzard and the Spirit Rider are both usable as strike fighters because of their torp loads. The Revenge is clearly built as a strike fighter, although it has the bulk, speed, and armor of a heavy fighter.

Superiority — These fighters have one purpose in life, and that is to dogfight. They are designed to directly engage and shoot down other fighters. They tend not to rely on expendable ammunition, and feature heavy armaments up front. Examples include the Night Hawk and the Teal Hawk.

Multi-mission — A multi-mission fighter is a good choice when you do not know what you’re going to face. They try to do a little bit of everything, although they will not do a given task as well as more specialized craft. These fighters tend to be medium two seaters, with fairly good speed and toughness, as well as good to excellent offensive capability. They function well in both strike and superiority roles, but are usually too expensive to use as attrition fighters. The Salamander, Death Wind, and the Sorenson III are examples of multi-mission fighters.

Heavy — A heavy fighter is designed to go one-on-one with other heavy fighters, or take on several smaller fighters at once. They are also a good choice for engaging gunboats. Heavy fighters are not very quick, so be careful not to deploy them in such a way as to slow down the rest of your force. They can provide good cover for lighter craft, especially if you have some damaged fighters. Your wounded ships can find at least some safety under the guns of their bigger relations: the Glaive, Pharsi II, Sentry, and Seraph.

The Next Millennium

The Last Debriefing

Flight Officer Ghengis Wilson Kemp, 999th Luches Utopian Assault Group, stepped up to the Political Officers debriefing desk and gave a parade-ground-perfect Luches military salute; right arm extended straight out at a 45 degree angle, palm of the hand down, and all fingers together pointing forward. The Political Officer looked up from his monitor and returned Kemp’s salute in the same textbook fashion. The Political Officer then summoned his aide to the office to take Kems statement for

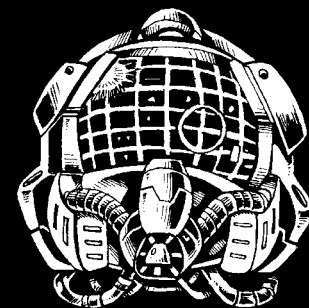

Silent Death

the record. As soon as the NCO had entered the room and activated his recorder the Political Officer—whom Kemp detested as a martinet of the worst kind—spoke without preamble, “This is the mission debriefing of the sole survivor of the failed mission to intercept the Karelian convoy designated RXB-433. State your name, rank, and service number for the record.”

Kemp complied with all the preliminary questions put to him for the record with a feeling of impending disaster; there had been three other pilots who had

Gunboats

“The commander must decide how he will fight the battle before it begins. He must then decide how he will use the military effort at his disposal to force the battle to swing the way he wishes it to go; he must make the enemy dance to his tune from the beginning, and never vice versa.”

—Montgomery of Alamein, *Memoirs*, vi, 1958

These behemoths feature multiple damage tracks. They are slow, plodding monsters with little subtlety. A gunboat is designed to deliver a lot of firepower in a short space of time, and can absorb frustrating amounts of punishment. Some, like the Betafortress and its variants, can destroy smaller fighters with almost casual dispatch. Others, like the Drakar, have their heavier firepower committed to weapons that do not track smaller ships well enough to hit them. Without proper escort these ships become easy targets for more nimble classes of ships. Used properly, gunboats can wreck other gunboats or heavy fighters, and seriously disrupt formations of lighter craft. Other gunboats include the Epping and the Star Raven.

Learning by Experimentation

“Employment of troops must be in accord with determination of the enemy’s strong and weak points, after which you speedily attack his critical positions.”

—Wu Ch’i, 430-381 BC, *The Art of War*, ii

When real armies want to experiment with new battle tactics or weapons without the benefit of a real war, they hold exercises and wargames. You should do the same. In addition to studying the ships in the *Silent Death* universe, play a few games solitaire. Set up simple scenarios

to help you with a particular area where you have trouble during games. Test out your ideas. Are a pair of Thunderbirds really an effective defense against a Night Hawk? Do not be afraid to question the accepted tactical ideas, including the ones in this book! Taking notes and exploring problems on paper helps you to understand the game. We have included special note pages in this manual that you can photocopy and use for making your own notes. Keep records of what works and what does not. If you come up with something brilliant, write it down so you can remember how you did it and improve on it. After you play a regular game, write down what went well and what did not. You may find yourself muttering, “Well I will not ever try that again!” Do more than just mutter it, write it! It may sound tedious, but other than actual game experience, this is the most efficient way to develop sound tactical doctrines.

Basic Tactical Concept Exercises

1. You want to swing your diamond formation of Night Hawks from position A to position B. They have a drive of 15. Is it possible to perform this maneuver and maintain formation?
2. True or False: Dividing your forces will make them harder to attack.

EXERCISE EXAMPLE I

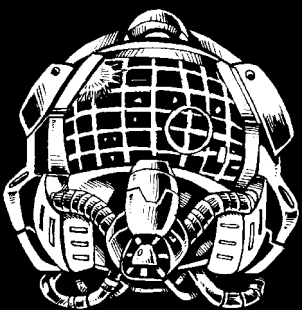
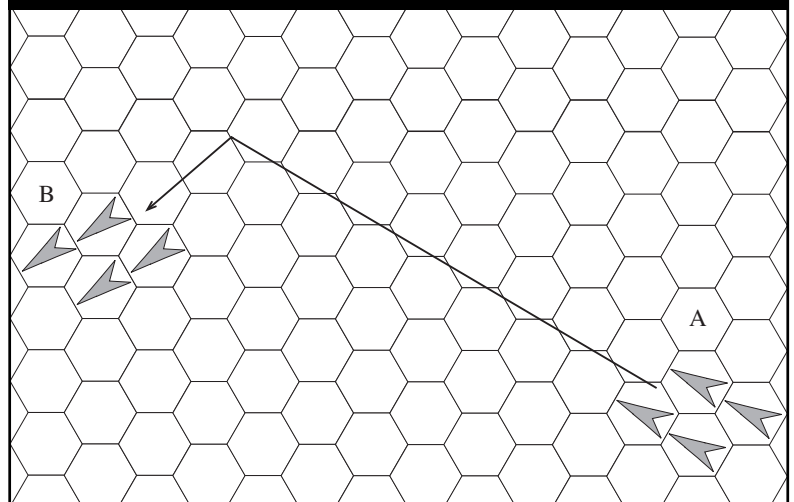

3. True or False: If you and your opponent have about the same number of ships, with about the same fighting ability, then it is more efficient to pair two of your ships against one of his, even if it means you will not engage all his group on any given turn.
4. Your opponent is attacking you with a force consisting of two Glaives and four Lance Electras. Your force has different ships but is comparable in strength. Where should you direct the bulk of your firepower, and why?
5. Your attacks have reduced the speed of an enemy heavy fighter to 7. Other opposing ships are approaching, and much of your ammo is expended. However, you still have several torpedoes left. Should you stick around and finish the heavy fighter off?
6. True or False: a three-ship Lufbery Circle prevents all attacking ships from getting close enough to strike without getting shot at themselves.

Weaponry

“The unrelenting progress of mankind causes continual change in the weapons; and with that must come a continual change in the manner of fighting.”

—Mahan, 1840-1914

Warheads - Missiles

“There is only one tactical principle which is not subject to change. It is: to use the means at hand to inflict the maximum amount of wounds, death and destruction on the enemy in the minimum of time.”

—George S. Patton, Jr.,
War as I Knew It, 1947

Missiles are excellent for hit-and-run combat. You do not have to deal with the same range limitations as other cannon or projector weapons. A distance of ten hexes is as good as one hex as far as hitting your target is concerned. Once your gunner acquires a lock, firing a salvo of ten missiles will do damage at the end of the turn. There is no waiting around while torpedoes close with their uncooperative targets. Best of all, the movement phase comes after the warhead phase and before the cannon-fire phase. Unless your target also launches missiles, you can usually slip out of reach before your target can return fire. You can also close for a quick burst and let the missile results administer the coup de grace. If you retreat, your opponent must decide whether or not to pursue. A quick, sharp missile strike followed by an organized re-

treit is a nice way to create a diversion or bait a trap. It is also a good way to get your opponent to break formation in order to pursue. Further, the maximum missile range of ten hexes is enough to be safe from torpedo attacks for at least one turn, if you make your moves right. We will demonstrate this in the section below on torpedoes.

Warheads - Torpedoes

“Battles are won by superiority of fire.”

—Frederick The Great, Military Testament, 1768.aa

Evading Torpedoes

“With many calculations, one can win; with few one cannot. How much less chance of victory has one who makes none at all! By this means I examine the situation and the outcome will be clearly apparent.”

—Sun Tzu, 400-320 BC,
The Art of War, i

Many players do not really pay attention to torpedoes until they are being tracked by one, so let's discuss defensive measures first. You already know there are several ways to get rid of torpedoes, such as jamming, attacking, and dodging them when they close in. You can shoot them down if you like, but we recommend you avoid that whenever possible. Surely there are more impor-

The Next Millennium

returned with him from the failed attack on that convoy. “Sole survivor” meant only one thing.

The Political Officer questioned Kemp mercilessly for over an hour, nitpicking at everything Kemp said. Kemp wished he could leap over the desk and throttle the pompous little rodent. The explosive collar around Kemp's neck, worn by everyone in the armed forces of the Luches Utopia, kept him in check. He was beginning to wish he had died with most of the rest of his squadron attacking that damned

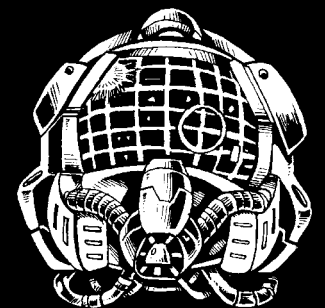

Silent Death

STANDARD RULES TORPEDO KILL ZONE

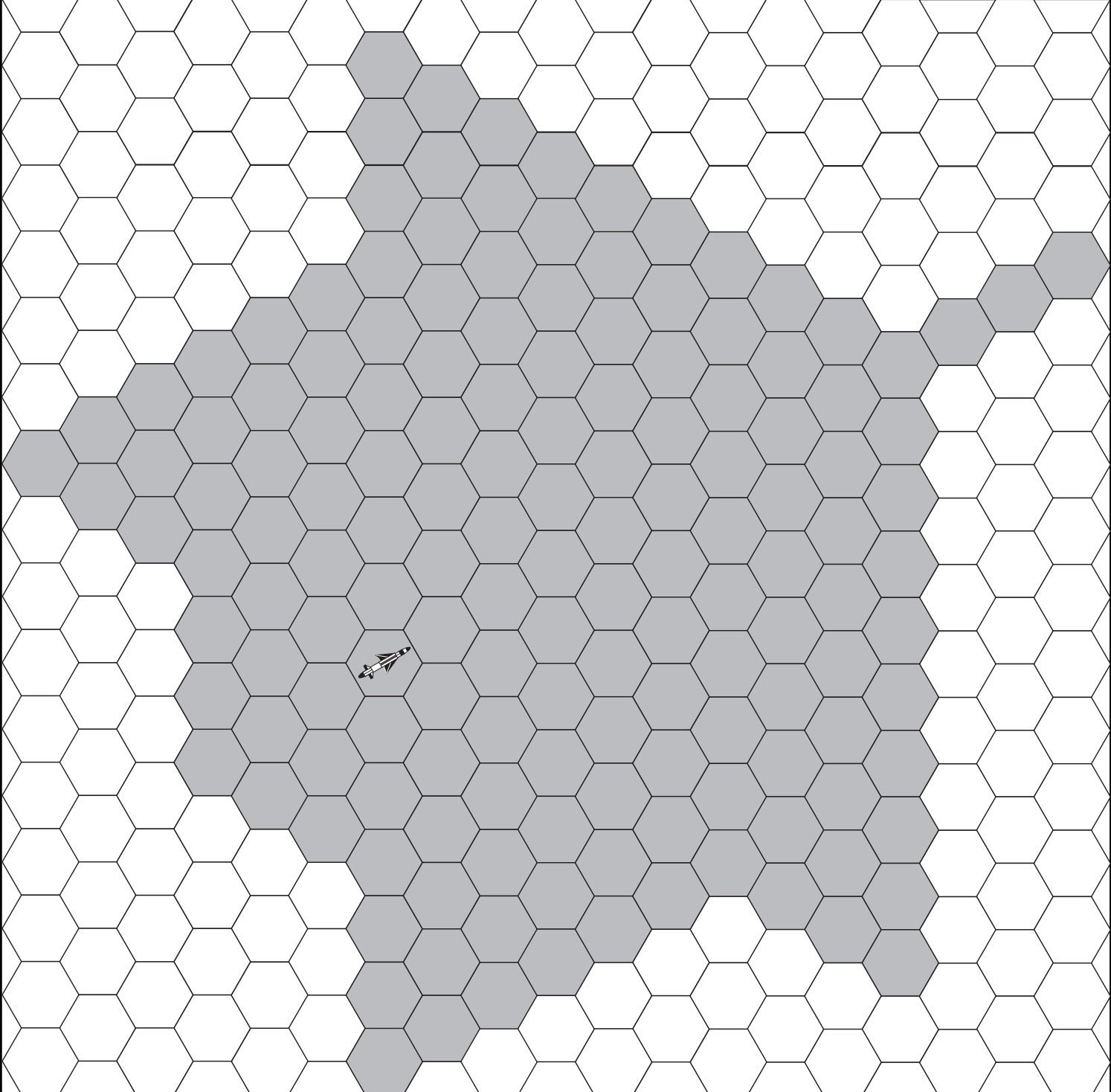

tant targets demanding your attention. This section covers what we call “evading” torpedoes, which is not the same as “dodging.” Briefly put, evading is the art of never letting the pesky devils get close enough to require dodging in the first place.

How do we accomplish this miracle? The key lies in knowing exactly what the torpedo can and cannot do. In the basic rules torpedoes have a drive of twelve. They spend three drive points to turn one hex face; they do not execute “tight turns”. When you map out all the possible hexes a torpedo can reach in one turn, you get a map of the torpedo’s “kill zone.” The kill zone of a torpedo is shown in the diagram below. The figure of the torpedo shows the starting point and direction at the beginning of its move.

Find it surprising? If you ask most beginning (and quite a few advanced) players to describe a torp’s kill zone, they would likely tell you that it is roughly circular or ovoid. The diagram above demonstrates otherwise. Once you know where that torpedo can and cannot go, you can use this knowledge to your advantage.

Suppose your opponent launches a torpedo at a range of ten hexes, dead ahead. Well within range, one might think. So how many hexes do you need to move to evade it? One! Move one hex forward, either to the left or the right, and watch unconcernedly as Mr. Torpedo just falls short. Now, for style points, blow a raspberry at the opposing player.

Of course, the fastest way to lose both style points and your ship is to forget about the torpedoes tracking your ship. It can be so easy to get caught up in the hurly-burly of a rousing dogfight and forget those torpedo counters homing in on your fighters. If your opponent has torpedoes in play, never contemplate a move without first thinking about where those torpedoes are and who they are tracking. Pouncing on that fat, juicy target may—or may not—leave you open to a torpedo strike. Be alert. All the torpedo-evading sophistry in the world will not help if you forget to use it.

Important Safety Tip: *Remember, if you fly through a hex with a torpedo in it, and that torpedo is tracking you, it immediately hits you, and you do not get to attempt a dodge!*

Take another look at the torpedo range chart above. Notice that if you can get four hexes directly behind a torpedo, or into its adjacent right rear, rear, or left rear quarter, that torpedo cannot touch you! A good rule of thumb for doubling back on a torpedo is that if you can get four or more hexes beyond the torpedo, you’re safe. If you play with a careful awareness of a torpedo’s kill zone, you can bob out of reach long enough to give conventional countermeasures more time to work. It is also a great way to mess with your opponent’s mind.

To summarize, there are usually two options for evading a torpedo: (1) get out of the direct line of fire if the torpedo is far enough away, causing it to fall short; or (2) if the torp is too close for that, get several hexes past the torp’s rear, right rear, or left rear quarters, either by some tight maneuvering or overshooting it while heading opposite its flight path.

Remember, if you change to optional torpedo rules the shape of the torpedo’s kill zone will change. Do your homework! It will pay off later.

Evading Torpedoes Without Disrupting Your Formation

“Let no one imagine that it is sufficient merely to move an army about, to make the enemy regulate himself according to your movements. A general who has too presumptuous confidence in his skill runs the risk of being grossly duped. War is not an affair of chance.”

—Frederick the Great, Instructions for His Generals, xi, 1747

A head-on torpedo assault need not disrupt your fighter formation. If you use the optional rule to allow sideslipping for fighters, they can easily switch positions, sideslipping past oncoming torpedoes and overshooting them. Remember, you need to get at least three hexes past a torpedo, heading in the opposite direction. If you do it carefully, your fighters may not be in the same relative positions they were before, but your formation will be intact. Generally, a Finger Four formation is more effi-

The Next Millennium

convoy! It was the Political Officers final question, though, that caused him to lose his temper.

“So, Pilot, what I still fail to grasp is whether or not you in fact pressed your attack on the convoy’s escorting fighter contingent. Could you possibly enlighten me on this, hmm?”

Kemp thought of the convoy, escorted by a dozen Sentry class fighters, and how upon detecting Kemp’s squadron closing to attack, the Sentries executed a maneuver Kemp and his now deceased fellow pilots had neither seen before nor been trained to

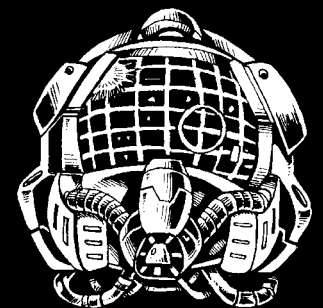

Silent Death

deal with. The Sentries had begun to fly in a circle around the freighters, while the freighters flew in a counter-rotating circle inside of the fighters.

Kemp recalled that every attempt he and his squadron mates had made to cross the outer ring of fighters had ended in disaster as the combined fire of multiple SentRy fighters would immediately concentrate on the lead fighter, tear it to pieces, and then immediately shift to another. It hadn't even been a real dogfight at all, rather a systematic butchering of Kemp's squadron. The freighters were hardly scratched.

cient at evading oncoming torpedoes than a Diamond, because the Diamond requires an extra hex of range to make up for the extra hex of depth in the formation. If torpedoes are inbound at an angle to your heading, the Diamond evades more easily while maintaining formation integrity.

Attacking With Torpedoes

"A superiority of fire, and therefore a superiority in directing and delivering fire and in making use of fire, will become the main factors upon which the efficiency of a force will depend."

—Ferdinand Foch, Precepts, 1919

Now that you know more about the capabilities of your weapons, you can incorporate that knowledge into your tactical decisions. Attacking with torpedoes is trickier than getting away from them. In the *Silent Death* universe, torpedoes have four primary roles:

- Attacking fighters
- Scattering fighter formations
- Attacking torpedoes
- Attacking heavy vessels preparatory to or in place of fighter attacks

Once you've established your target priorities, you must decide how many torpedoes to use. If you are attacking other torpedoes, one torpedo per torpedo is a fairly safe bet. However, be advised that torps can attempt to dodge incoming torps, and will dodge successfully on a roll of 7 or better. That translates to a 40% chance of success.

Attacking ships is a lot trickier than plinking at other torpedoes. Do not attack a ship with a single torpedo if you expect to do it any harm. Single torpedoes are easier to dodge and jam than multiple torpedoes. Do the math. In a single turn, you have a 25% chance of jamming the torpedo. The probability of dodging a single torpedo for an average pilot are roughly 20% to 30%. All told, a single torpedo has nearly a 50% chance of missing with just conventional countermeasures over two turns, to say nothing of attacking a ship that uses torpedoes, missiles or cannon fire to de-

fend itself. If your target manages to stay out of reach for three or more turns, the odds of jamming successfully are even higher. Single torpedo attacks are only good for encouraging ships to break formation, delaying reinforcements from joining up, or just keeping someone distracted. Of course, you may get lucky, or your opponent may miscalculate, and a "pest" torpedo will connect. In that case, think of it as an unexpected bonus.

When to release torpedoes is a tricky question. Largely, it depends on what you want to accomplish, and what you're up against. If your target is too big and nasty to close with, you may choose to launch your torpedoes from further away. If you release from, say, 5 or 6 hexes away, the only option your opponent has for evasion is to either outrun if the torpedoes are heading for a rearward quarter, or overshoot them if they are coming in from the front. Knowing this, you can use torpedoes to "flush" your quarry, and deploy your forces to where your opponent must go to escape the torpedoes.

The number of torpedoes you decide to commit to a target depends on several factors. Perhaps the most important thing to consider is the skill of the enemy pilot. If you want to know the maximum number of torpedoes a pilot can dodge, divide the piloting skill by 2 and round off the remainder. This is how many torpedoes that pilot can dodge if he rolls 10 on a D10 during the dodge attempt. If a Pit Viper is about to get hit by eight torpedoes, even if the pilot has a skill level of nine, realize that it might dodge a few, but it will get well and truly clobbered. Of course, if someone is willing to waste eight torpedoes on a Pit Viper, either they aren't very smart about conserving ammo, or the Pit Viper in question is - was - the last opposing ship on the board.

That being said, if you want to make certain that a target takes a hit, attack it with more torpedoes than it can handle. Since the heaviest torpedoes are dodged last, putting at least one or two heavy torpedoes into the spread is good insurance. Friendly Reminder: gunboats cannot dodge torpedoes.

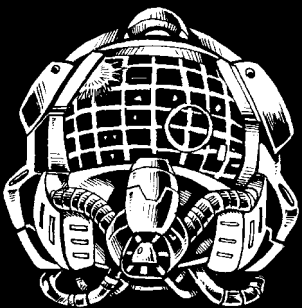

Coordinating a Multiple-Ship Torpedo Attack

“All movements on the battlefield have but one end in view, the development of fire in greater volume and more effectively than that of the opposing force.”

—T. Miller Maguire, *The Development of Tactics*, 1904

If you mean to overwhelm selected targets with large numbers of torpedoes, those torpedoes are probably going to come from two or more ships. Launching a successful torpedo strike with more than one ship requires coordination and timing. Few fighters carry enough torpedoes to swarm a skill level 10 pilot, so you usually have to launch your attacks from separate ships. If your torpedoes are going to have maximum effect, they need to arrive on target at the same time. In naval parlance, firing so that all the ordinance arrives at once is called “time on target.” If they straggle in by one’s or two’s over a period of several turns, a really crack (or lucky) pilot can dodge many, if not all of them. A pilot with a skill level of ten only needs to roll a 2 or better to dodge a single torpedo. That’s a 90% chance of success. Dodging a pair of torpedoes can be done with a four or better (70% chance). It might be a waste of time even to try and evade them. Instead, the pilot can close with a target, line up good shots at your ships, torpedoes be damned, and dodge them as they arrive at the end of the movement phase. A risky operation, but still quite feasible. Pilots with average or lower piloting skills are not advised to take such a cavalier attitude toward inbound torps.

Another thing to consider when dealing with multiple torps is that, your damage reduction applies to both torps if they hit separately. If they all hit at once, the damage reduction is only applied once. For example, suppose you get hit twice by two Mk. 10 torps on two separate turns. The damage of the first one is 7, and the second one is 9.

If your original damage reduction is 4, that would apply to the first hit, reducing it to 3. If your ship is fairly

robust, that would not be enough to lower your damage reduction, and the second torpedo would only do 5 points damage for a total of 8. If they both hit at once, damage reduction would only be applied once, and the total damage would be 12 instead. On several fighters, that can be enough to get a critical hit, lower the damage reduction or lower the drive.

Here are some basic rules to help put your torpedoes where and when you want them.

First, ships launching against a single target should all be about the same range from the target, or far enough inside torpedo range that all torpedoes can impact on that turn. Second, the angle formed by the attack vector of any ship’s torpedo spread and the target’s line of flight should be fairly shallow.

You want the torpedoes to come in close to the right and left sides of the enemy ship. This gives the torpedoes time to form one large cluster prior to impact, even if the target breaks to one side. If the angle is too steep, and the individual spreads consist of no more than two torpedoes, a competent pilot can purposely close with the first group, attempt a dodge, and if the ship is still in one piece, he can try the same with

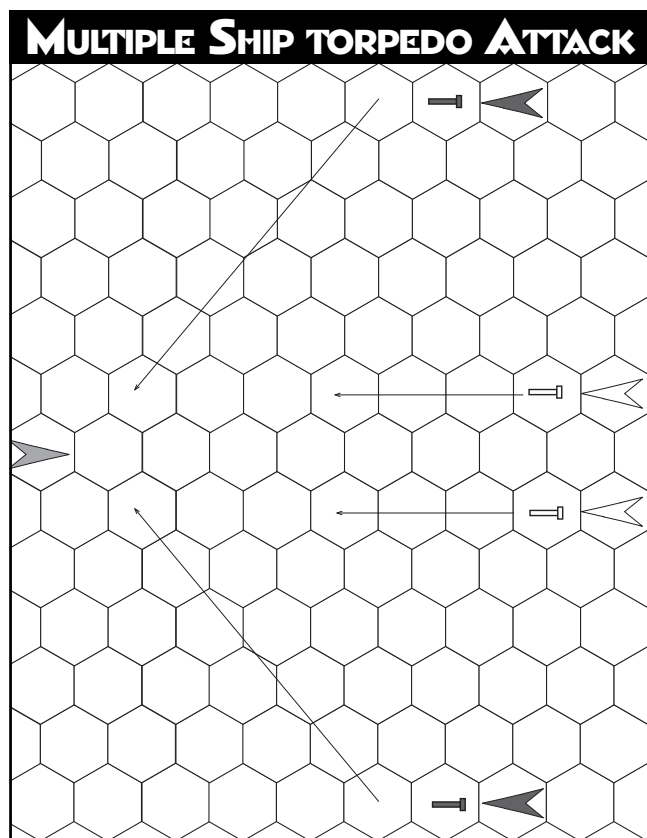

The Next Millennium

Recalling all those good pilots dead with nothing to show for their sacrifice, Kemp’s temper finally snapped. “So! the Political Officer wishes to know whether or not I and my pilots pressed the attack on the enemy convoy escorts?” snarled Kemp.

“That is correct, Pilot,” hissed the political officer, “Do not become insubordinate!”

“I’ll ask you something, my dear Political Officer: have you ever tried to French kiss a Sea Urchin?!”

Stunned silence reigned supreme in the room...

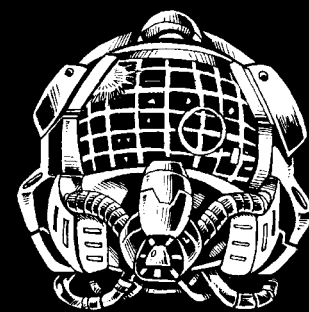

Silent Death

the second spread. In the diagram above, two coordinated attacks against a gray ship are shown. The black ships are using too steep of an angle. Their torpedoes cannot join up prior to impact, and they can be engaged and hopefully dodged piecemeal. Contrariwise, the white ships launched their torpedoes in such a way that the torpedoes will join up even if the target breaks left or right in an effort to evade. When they finally reach the target, dodging will be a much lower-percentage proposition.

Allowing your opponent an extra torpedo dodge may not seem like such a big disadvantage. However if you are attacking a fighter with spreads from two ships (assuming each spread is small enough to allow a chance of dodging), and give the enemy two chances to dodge instead of one, you cut your odds of a hit in half. By the same token, the enemy's chances of dodging successfully are doubled.

Using Torpedo Spreads to Disrupt Enemy Formations

"To pin an opponent is the vital prelude to a decisive maneuver; this dual act gives a double meaning to the old maxim— 'divide and conquer.'"

—B. H. Liddell Hart

A torpedo does not actually have to make contact to make life interesting. If your attention is directed on getting away from a torpedo, things like shooting at the enemy or maintaining formation lose priority. Besides, if your opponent gets confused or unlucky, some of those torpedoes may even connect. Anything they do then is gravy.

When you set up a torpedo spread with formation-breaking in mind, you would do well to take a page from the tactics manual of medieval Mongol armies. They purposely left their enemies a way out, so they knew in advance which way the pursuit would go and could follow up accordingly. The Mongols understood that if hard-pressed troops who feel surrounded see a direction they can run, they will most likely run. Men that ran were too busy running to fight, and the Mongols mowed them down at their leisure. The point is, do not completely box your enemy in. Strike hard, and leave one direction to run. If each ship gets attacked by a torpedo spread from a different direction, each target will perceive a different "safe area." If the targets make a break for their respective safe areas, you will have succeeded in scattering the formation. Although they will be moving apart, your ships will most likely be converging. Converge on one or two solitary ships, destroy them, and move on to some new stragglers. Another technique is to deploy your torpedoes to scatter part, but not all of the enemy formation, and then concentrate your attacks on what's left.

Hiding Behind Your Torpedoes

"It is not so much the mode of formation as the proper combined use of the different arms which will insure victory."

—Jomini, Précis de l'Art de la Guerre, 1838

If you have torpedoes tracking most of the nearby enemy vessels, you can use your own torpedoes' kill zones both to force the enemy ships into a weaker position and protect your ships.

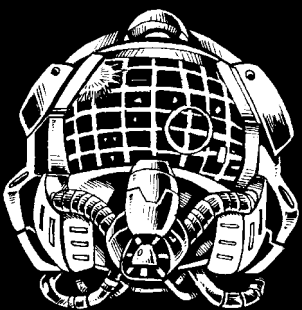
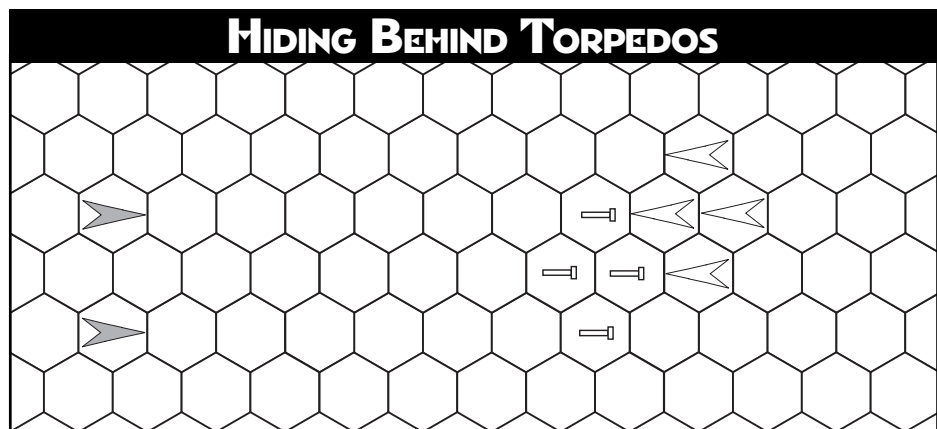

Suppose you command a squadron of four Spirit Riders squared off in a diamond against a pair of Hell Benders at a range of roughly 9 hexes. You launch torpedoes against the Hell Benders, spreading the torpedoes so as to box in the heavier fighters. You hope to maneuver your ships in order to get a group shot at the Front Left or Right Quarter of at least one Hell Bender, since Hell Benders can only fire forward. If you win the initiative, that might be pos-

sible during the next movement phase. But suppose you lose initiative?

One solution is to intentionally overshoot the Hell Benders so that your formation is just behind them facing the other way. This would be about 10 or 11 hexes ahead, depending on the position of each fighter in your formation (you are still in formation, right?). It may also be a good idea to switch from the Diamond to the Finger Four.

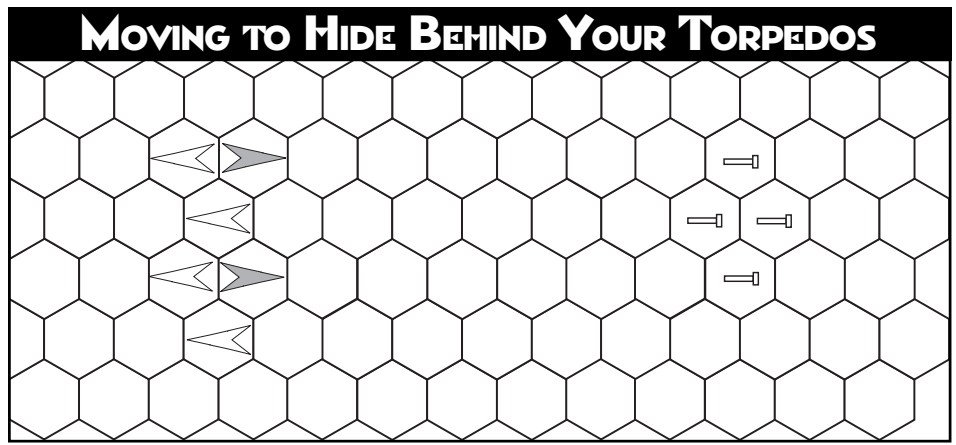

This creates an interesting situation. If the Hell Benders come about for a shot at your exposed Rear Quarter, they are still inside the kill zone of your torpedo spread. If they turn around and try to beat the torpedo, which isn't too difficult given the range, they could very well end up right in front of the guns of your four Spirit Riders, with their guns pointing the wrong way! If you switched to a Finger Four formation, you have widened your field of fire slightly, which may be just enough to draw a bead on a Hell Bender making a break left or right. Or, the Hell Benders may dash straight forward and overshoot the torpedoes that way, in which case they will not get a shot at your ships. This gives you a new chance to regain initiative on the next turn. Of course, since each player moves ships alternately, things will not turn out quite as neatly as the diagram shows it. The principle remains valid: your own torpe-

does can provide some cover as long as you remain inside or near their kill zone. Even better, sucker your opponent into attacking your ships and forgetting about the torpedo's kill zone. As long as your torpedoes are in flight, make good use of them.

We should note that there is one instance in which your torps will not help you. If you are being tracked by a torpedo, and that torpedo is in turn being tracked by a torpedo. If you and the two torps happen to meet in the same hex at the same time, even if the second torpedo hits the first one, if you do not dodge successfully, you will suffer damage. Remember this if you are trying to use your torpedoes to shoot down inbound torps. Try to maneuver in such a way that when the movement phase is over your torps will hit the inbounds before they reach your hex.

The Next Millennium

The Experiment

Captain Toini Smith, Squadron commander of the 1st Karelian Experimental Fighter Group's "Ice Witch" flight, looked across the hanger bay at the four strange, baroque-looking craft that constituted her squadron. Her ship crews had been allowed just three days to familiarize themselves with these new and as yet untried warcraft, and now they were being sent into battle for the first time due to the desperate nature of Karelia's brutal war with the Luches Utopia. Toini, ever the skeptic, had been an accountant before her

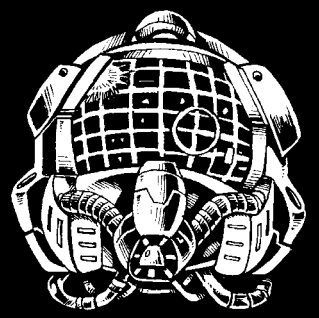

Silent Death

reserve status had been revoked and she'd been recalled to the colors. She looked with a suspicious eye at these odd birds despite all of the manufacturer's hype.

Not even the enthusiastic insistence of the ship's eccentric design team from Grivas Armaments about the new ship's impressive armament package would convince Toini of the ship's capability. In fact, the only reason the Karelian government accepted the crazy gooney birds was the sheer desperation of a besieged world. Only actual combat would prove or disprove the ship as a viable weapons plat-

Cannon Fire

"Whatever happens, we have got the Ion Ram, and they have not."

—Squadron Motto, 3078th Death Wind Regiment

Scoring a Hit, or, a Discrete Dissertation on Dice

"In war, as in love, we must achieve contact ere we triumph."

—Napoleon Bonaparte

Making a hit depends on the roll of the dice. Before we tackle the tactics of firepower, a short discussion of dice and their quirks is in order.

If you only have a single die, it is easy to figure out the odds of rolling any one number. On 1D6, the odds of rolling any possible number are 1 in 6. But suppose you have two D6s, and someone asks you to give the odds of rolling a 2. You might think that there are eleven possible outcomes, namely, from 2 to 12. So you say, "One chance in eleven." Nope, sorry. The chances of rolling a 2 are 1 in 36! The reason why is because there 6 x 6 possible outcomes with 2D6, but only one of those outcomes is a 2: two 1's. On the other hand, there are six ways to roll a 7: 1 and 6, 2 and 5, 5 and 2, and so on.

That is why the odds of rolling a 2 or a 12 are much lower than the odds of rolling a 7 or an 8. The diagram below shows the number of combinations out of the 36 possible result each number, 2 to 12 is expected to show up. The horizontal

axis shows the result, and the vertical axis shows the number of times each result is expected to happen.

As you examine the graph, you will notice some interesting things. First, as we mentioned, it is much harder to roll a 2 or a 12 than a 6. Take a look at a critical hits chart that uses 2D6. Notice where the "pilot killed" or "reactor explosion" results are located. They usually require a 12 or a 2. Keep this in mind. If you take a critical hit, the chances of either result is much lower than you might think. Do not assume that extremely high or low die rolls are as common as middling scores. That is not how the dice roll.

Another thing to consider is that if you can add a plus 1 to your roll, your odds to hit do not always change in the same way. Below is another chart, this time showing the expected outcomes for each dice combination of 3D6:

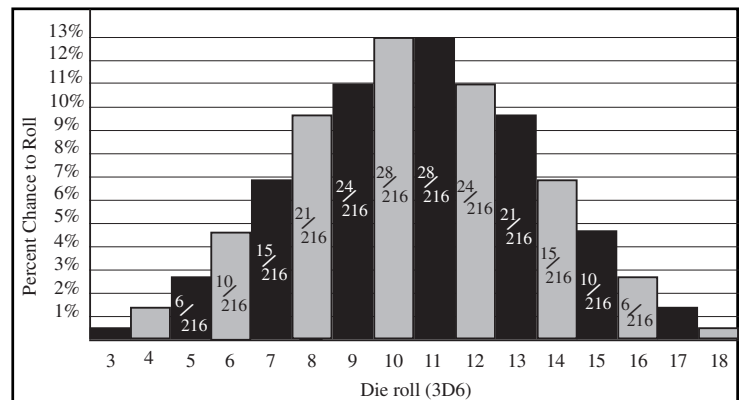

The data comes out to a rough bell-shaped curve. Now, if you needed a 13 to hit, everything under the curve and to the right of 13 on the horizontal axis represents a hit. If you have a plus 1, everything under and to the right of 12 represents your chances to hit. In that case, adding plus one adds a large chunk of the curve, and increases your chances by about 11%. But if you needed a 17 to hit, and you got a plus one, your odds increase by only about 3%.

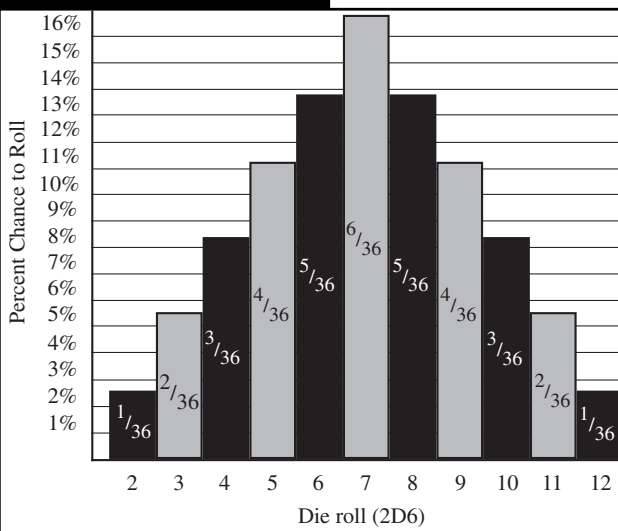

When you are assembling your next fleet, especially if you know what manner of force you must deal with, knowing your chances

to hit can be a great help. We created the following chart shown below to help you out.

PERCENT CHANCE TO HIT TABLE																
Def. Value	3	4	5	6	7	8	9	10	11	12	13	14	15	16	17	18
2D6+1D4	100	99	97	93	86	76	64	50	36	24	14	7	3	1	0	0
2D6+1D6	100	99	98	95	91	84	74	62	50	38	26	16	9	5	2	1
2D6+1D8	100	99	99	97	93	88	81	72	61	50	39	28	19	12	7	3
2D6+1D10	100	99	99	97	94	90	84	77	69	60	50	40	31	23	16	10
2D8+1D4	100	99	98	96	92	87	80	71	61	50	39	29	20	13	8	4
2D8+1D6	100	99	99	97	95	91	85	78	70	60	50	40	30	22	15	9
2D8+1D8	100	99	99	98	96	93	89	84	77	68	59	50	41	32	23	16
2D8+1D10	100	99	99	98	97	95	91	87	81	75	67	59	50	41	33	25

The left column gives all the different hit dice used by the cannon/projector type weapons in *Silent Death*, plus the ADBs. The top row shows the possible defensive values. The intersection of these rows and columns gives the percent chance of hitting a given defensive value with a specific set of dice. For example, 2D6 + 1D8 has a 72% chance of hitting something with a defensive value of 10. If you have plusses or minuses because of range, damage, or weapon type, add or subtract those values from the defensive value to compensate. If you know what kinds of ships you are likely to face, the table can help you decide what kinds of ships are capable of getting a hit, and how often they are likely to do so.

For example, if you are using a Spirit Rider with two Splatterguns (2D6 + ADB) at close range, the guns carry a +1, and close range gives you an additional +1. Assume your ADB is 1D8, and the defensive value of the target is 14. Use the row for 2D6 + 1D8, but reduce the defensive value by 2 in order to compensate for the two +1s. This gives a percent chance to hit of 50%.

You can also use the percentage table to determine the chance that a group of fighters will hit a single target. The best way to do that is to figure out the chances that all of the fighters will miss the target. Why? Because the inverse of that probability (100 minus the percentage probability) is the chance that at least one of the fighters will hit. To figure out the chance of all of the fighters missing, first figure the chance

each fighter will miss by subtracting the percentage chance they will hit from 100. Express all of these chances as decimals (so that 23% is 0.23) and multiply them together. The result will be the chance that all the ships will miss. The inverse of that will be the chance that at least one will hit.

Take our Spirit Rider above as an example. Suppose that Spirit Rider has a wingman, also with 1D8 ADB, at medium range firing on the same target. He gets +1 for the Splatterguns, but no bonuses for close range. According to the table, the wingman's chances to hit is 39%. The inverse of the two chances are 50% (100 - 50) and 61% (100 - 39). Expressing them as decimals and multiplying them together gets us $0.5 \times 0.61 = 0.305$. That means that the chance they will both miss is 30.5%. The inverse of that is 69.5%, and that is the chance that at least one of the two will hit.

Hitting is one thing. Inflicting damage is quite another. Planning an attack becomes easier if you can estimate the amount of damage you can reasonably expect to do. Expected damage is defined as the chance of doing damage multiplied by the average damage done. In games with a separate damage roll this is much easier to compute, but *Silent Death's* damage system depends on the roll to hit. Rather than how you how to calculate damage, we have generated tables showing the average damage for the various weapon systems and pilots. Remember when using these charts that the number given is the average damage of all the possible re-

The Next Millennium

form. Toini just hoped that she and her "kids" would live to report back if the darn things did not prove such a hot idea. The pre-flight check and launch proceeded routinely. They flew steadily toward the local hot zone, sensors keyed, guns at the ready.

"Point-oh-six-one-niner, Leader!" crackled over Toini's comm set. "I'm picking up a dozen blips vectoring on us now!"

"Keep it cool, people," replied Toini. "We're here to see what these ships are made of, so don't take any foolish chances!"

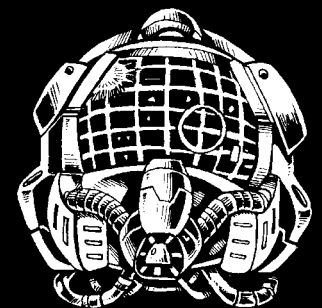

Silent Death

“How can I take notes, when I’m shooting at things?” joked the normally dour gunner Sgt. Juutilainen. Toini grinned to herself.

‘Let’s just hope that these ships were free for the right reasons!’ thought Toini.

The blips turned out to be a mixed group of Luches Pharsii IIs and Salamanders in equal numbers; that this was going to be some test indeed was not lost on the nervous Karelian fighter crews.

The Karelian four-some turned toward the inbound Luches ships and both groups began to close in a head on confrontation. The Luches formation had spread out into a

sults. These charts can tell you what you can reasonably expect if your four Pit Vipers decide to tangle with a Sorenson III, assuming each one can get at least one shot off. Assume each Pit Viper has 2D8 + 1D8 + 2 attacking a target with a defensive value of 12. Because of the +2 you would look at the 10 column of the Low Expected Damage Chart. This gives you a result of 2.87 expected Low damage. However, the Pit Vipers do Low + 2 damage, so the actual expected damage is 4.55 (2.87 + (2 x .85(the chance to hit))) for each ship. Adding together the expected damage for the Pit Vipers shows that you can expect 13.65 points of damage if you attack the Sorenson III. The actual

damage of the attack will obviously be above or below 13.65, but this gives you a rough idea of how much damage you will do.

Now, we should mention at this point that we do not think you need to consult the percentage table and run the numbers on every turn. That would slow the game down, and we certainly do not want that. The best way to use the percentage table is when you are experimenting with different scenarios, deciding what ships to buy for a campaign, or analyzing what happened during a previous game. Also, remember that the percentage table covers cannon and projector fire only. Missile and torpedo hits are determined by different factors.

EXPECTED LOW DAMAGE

Def. Value	3	4	5	6	7	8	9	10	11	12	13	14	15	16	17	18
2D6+1D4	2.43	2.41	2.37	2.31	2.18	2.01	1.78	1.51	1.17	0.88	0.55	0.3	0.1	0.03	0	0
2D6+1D6	2.72	2.71	2.68	2.64	2.56	2.43	2.26	2.04	1.76	1.49	1.15	0.85	0.57	0.35	0.15	0.08
2D6+1D8	2.82	2.81	2.79	2.76	2.69	2.6	2.48	2.3	2.08	1.84	1.55	1.26	0.97	0.7	0.44	0.28
2D6+1D10	2.88	2.87	2.85	2.83	2.78	2.7	2.6	2.46	2.29	2.09	1.85	1.59	1.33	1.06	0.79	0.57
2D8+1D4	2.46	2.45	2.43	2.39	2.32	2.22	2.1	1.93	1.71	1.48	1.2	0.93	0.66	0.44	0.25	0.14
2D8+1D6	2.92	2.91	2.89	2.87	2.82	2.75	2.66	2.52	2.35	2.15	1.9	1.63	1.35	1.07	0.78	0.55
2D8+1D8	3.16	3.16	3.15	3.13	3.09	3.04	2.97	2.87	2.72	2.56	2.35	2.12	1.86	1.58	1.29	1.03
2D8+1D10	3.28	3.28	3.27	3.25	3.23	3.18	3.13	3.04	2.93	2.8	2.62	2.42	2.2	1.95	1.68	1.41

EXPECTED MEDIUM DAMAGE

Def. Value	3	4	5	6	7	8	9	10	11	12	13	14	15	16	17	18
2D6+1D4	4.49	4.47	4.42	4.28	4.07	3.73	3.26	2.69	2.08	1.47	0.94	0.54	0.24	0.08	0	0
2D6+1D6	5.15	5.14	5.11	5.01	4.88	4.63	4.26	3.82	3.29	2.67	2.03	1.4	0.88	0.5	0.25	0.08
2D6+1D8	5.15	5.14	5.12	5.05	4.94	4.75	4.48	4.12	3.69	3.16	2.58	1.98	1.39	0.9	0.53	0.27
2D6+1D10	5.21	5.21	5.19	5.13	5.05	4.9	4.68	4.39	4.04	3.6	3.1	2.56	2.01	1.5	1.05	0.66
2D8+1D4	4.99	4.98	4.96	4.88	4.76	4.57	4.3	3.93	3.49	3.02	2.5	2.01	1.52	1.09	0.7	0.4
2D8+1D6	5.51	5.51	5.49	5.43	5.36	5.22	5.01	4.73	4.37	3.93	3.42	2.87	2.28	1.72	1.24	0.82
2D8+1D8	6.12	6.11	6.1	6.06	6	5.89	5.74	5.51	5.22	4.86	4.42	3.93	3.38	2.79	2.22	1.65
2D8+1D10	6.18	6.18	6.17	6.13	6.096	5.88	5.7	5.46	5.16	4.79	4.37	3.88	3.35	2.8	2.23	

EXPECTED HIGH DAMAGE

Def. Value	3	4	5	6	7	8	9	10	11	12	13	14	15	16	17	18
2D6+1D4	5.47	5.45	5.41	5.26	5.01	4.59	3.99	3.22	2.44	1.67	1.04	0.57	0.25	0.08	0	0
2D6+1D6	6.12	6.11	6.08	5.99	5.82	5.51	5.04	4.4	3.71	2.92	2.17	1.46	0.9	0.5	0.25	0.08
2D6+1D8	6.47	6.46	6.44	6.36	6.24	6.01	5.66	5.15	4.56	3.83	3.09	2.33	1.62	1.03	0.61	0.3
2D6+1D10	7.08	7.07	7.05	6.99	6.89	6.71	6.42	6.02	5.54	4.94	4.27	3.53	2.78	2.08	1.45	0.91
2D8+1D4	6.61	6.6	6.57	6.49	6.35	6.11	5.78	5.29	4.68	3.95	3.2	2.46	1.81	1.25	0.79	0.43
2D8+1D6	6.98	6.97	6.95	6.9	6.8	6.63	6.37	5.97	5.47	4.83	4.14	3.39	2.65	1.95	1.38	0.89
2D8+1D8	7.59	7.59	7.58	7.54	7.46	7.34	7.14	6.83	6.4	5.85	5.23	4.54	3.83	3.09	2.41	1.76
2D8 + 1D10	7.98	7.97	7.96	7.93	7.87	7.77	7.61	7.36	7.02	6.57	6.03	5.4	4.73	4	3.3	2.58

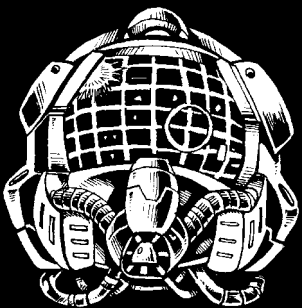

EXPECTED ALL DAMAGE

Def. Value	3	4	5	6	7	8	9	10	11	12	13	14	15	16	17	18
2D6+1D4	9.5	9.48	9.4	9.19	8.77	8.09	7.09	5.84	4.45	3.08	1.91	1.01	0.42	0.11	0	0
2D6+1D6	10.5	10.5	10.4	10.3	10	9.53	8.75	7.71	6.46	5.08	3.69	2.43	1.46	0.76	0.32	0.08
2D6+1D8	11.5	11.5	11.4	11.3	11.1	10.8	10.2	9.38	8.33	7.11	5.78	4.42	3.16	2.07	1.23	0.64
2D6+1D10	12.5	12.5	12.5	12.4	12.2	11.9	11.5	10.8	9.97	8.96	7.79	6.53	5.24	3.99	2.84	1.85
2D8+1D4	11.5	11.5	11.4	11.3	11	10.7	10.1	9.37	8.36	7.15	5.84	4.52	3.32	2.26	1.39	0.72
2D8+1D6	12.5	12.5	12.5	12.4	12.2	12	11.5	10.9	10	8.96	7.74	6.42	5.08	3.79	2.66	1.73
2D8+1D8	13.5	13.5	13.5	13.4	13.3	13.1	12.8	12.3	11.6	10.7	9.59	8.37	7.05	5.71	4.39	3.2
2D8+1D10	14.5	14.5	14.5	14.4	14.3	14.2	13.9	13.5	13	12.2	11.3	10.2	9.02	7.73	6.4	5.1

Combined Arms - Using a Mix of Weapons

"In no other profession are the penalties for employing untrained personnel so appalling or so irrevocable as in the military."

—Douglas MacArthur, Annual Report Chief of Staff, U. S. Army 1933

Each weapon has limitations. Some, like Meld Lasers, cannot hit a target that moves faster than twelve. Others, like Protobolt Projectors, cannot hit anything closer than five hexes. Be aware of these factors when you are building your fleet. If you build your fleet with all Lance Electras, someone can dash inside your Protobolt range after the warhead phase and get free shots on your ships unless they are carefully arranged to provide overlapping fire support. Do not make it any harder on yourself than you have to. Make sure you are familiar with the weapons at your disposal. Choose them carefully to suit your style of play, and what you know about your opponent.

This is another situation where thinking about the minimum amount of damage done by a weapon can help your planning. If you are facing someone with missiles for example, a salvo of ten missiles guarantees an amount of damage greater than or equal to the defensive value of its target. That is enough to cripple or destroy many light fighters, and slow down quite a few medium fighters. Keep these ideas in mind, and you will have a better idea what to expect from your armaments.

Use your ammo judiciously. Is the other player just one point away from a critical hit, or losing a weapon of your choice? Are you targeting a torpedo? One torpedo, maybe two, ought to do the trick. If you acquire a missile lock with a salvo of ten missiles, the damage is virtually assured. The same is true of Protobolt Projectors. Once you hit, the damage is fixed and certain. The Ion Ram does "All" damage, so you know that if you roll high enough to hit, you will do an amount of damage greater than or equal to the other fighter's defensive value. Other kinds of weapons are less obvious. If you have a weapon that does "Low + 3," then the minimum you will do is 4 points of damage.

Another consideration is the order in which you use different weapons. This is partly dictated by the skill of your gunners, since the better gunners fire first. But suppose one Night Hawk and two Pit Vipers pounce on a stray Teal Hawk. If the Night Hawk hits with its Splatterguns, it will do Medium + 10 damage, while the Pit Vipers will do Low + 2 each. Unless the Pit Vipers get lucky and come up with low doubles, most of their damage will be absorbed by the Teal Hawk's damage reduction of 4. A reasonable amount of damage inflicted by a Night Hawk is enough to reduce the Teal Hawk's damage reduction from 4 to 2. This buys the Pit Vipers two extra points of damage apiece, assuming they hit on later turns. Consider putting your best gunners behind your biggest guns for this reason. Once they "break open" a ship and take down its damage reduction, it clears the way for less powerful weapons to finish the job.

The Next Millennium

horseshoe formation with the Pharsiis in the center and the Salamanders on the wings. The Luches formation was looking to hit the Karelans head on with their best ships and harry them on the flanks with the more nimble Salamanders; these were not the hastily trained, press-ganged pilots usually encountered by the Karelans.

Within seconds the range had been closed and the Luches flight began to launch torpedoes. The Karelans flight countered by launching all of their torpedoes on intercept vectors, effectively neutralizing the bulk of the Luches torpedo barrage. The

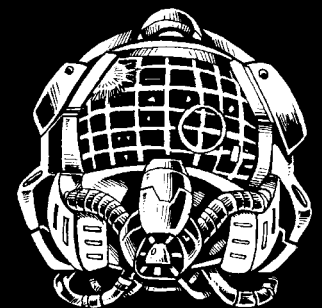

Silent Death

remainder would be dealt with by the substantial load of decoys carried by the experimental ships as the designer had insisted, or so Toini and her squadron members hoped.

Holding their fire until optimum range had been reached, both sides opened fire almost simultaneously. Toini hit the firing stud on her control stick, concentrating her fire on a Pharsii that closed head on with her, firing his own guns. Just liked she had trained them, Toini's gunners followed her lead and fired on the same ship in the head on cannon duel. Dodging the fire of the Pharsii's forward

Don't Forget Your Tailgunner!

"Always mystify, mislead, and surprise the enemy."

—Stonewall Jackson, 1824-1863

If you have more than one crew member in a ship that can use a weapon, take or make any and every opportunity to bring all your weapons into play.

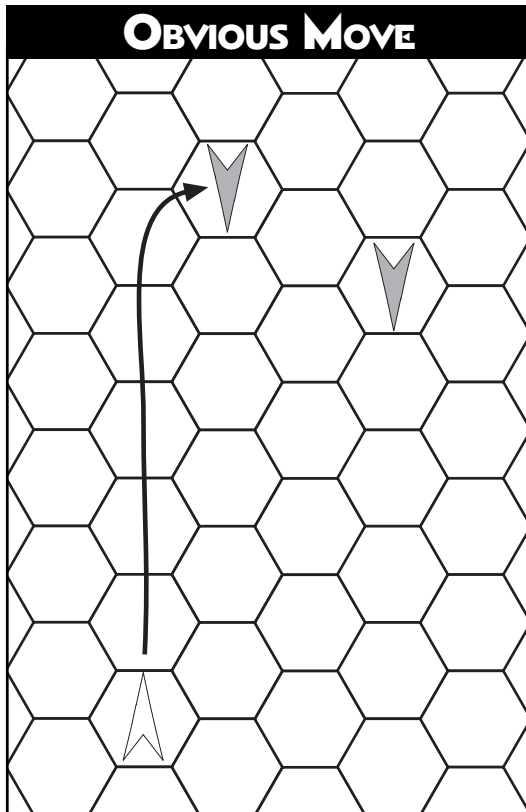

In the diagram above, player one confidently advances his two Pharsii IIs (gray) to within a few hexes of a lone Salamander (white) assigned to delay the heavy fighters until reinforcements arrive. Since they are in the movement phase, an obvious ploy for the Salamander is to get into the closest Pharsii's right forward arc where it cannot return fire, and unload with the pilot's Impulsegun and the gunner's Pulse Laser. But this player is smarter than that! She slips her craft straight between the two oncoming ships, and pulls a single facing turn where the move ends between the Pharsii's. Note that the Salamander is outside the usable firing arcs of both ships. Now, she can bring her gunner into play and get a free shot at one ship with two rear Splatterguns instead of the weaker pulse Laser!

We should also point out that if the Pharsii's had kept a tighter formation, the Salamander could not have been such a pest. Now, while this goes against our rule of concentrating firepower as much as possible, the objective of the Salamander is to slow the enemy down, to harass them and distract them until the cavalry comes to the rescue. Even if it had used both the pilot and the gunner on the same ship, in all likelihood it would only have annoyed the heavier ship. So why not annoy two ships instead of one? Firing on both ships increases the chances that one Pharsii would stop and turn on the Salamander, thus disrupting its advance. Also, do not forget that a Pharsii takes a crit on the 12th hit. Although scoring that much on even one of them is unlikely, it is still possible! Who knows what might happen then?

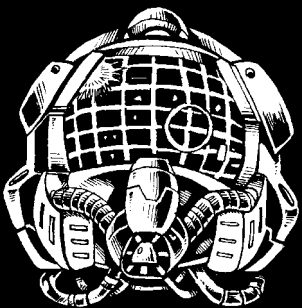
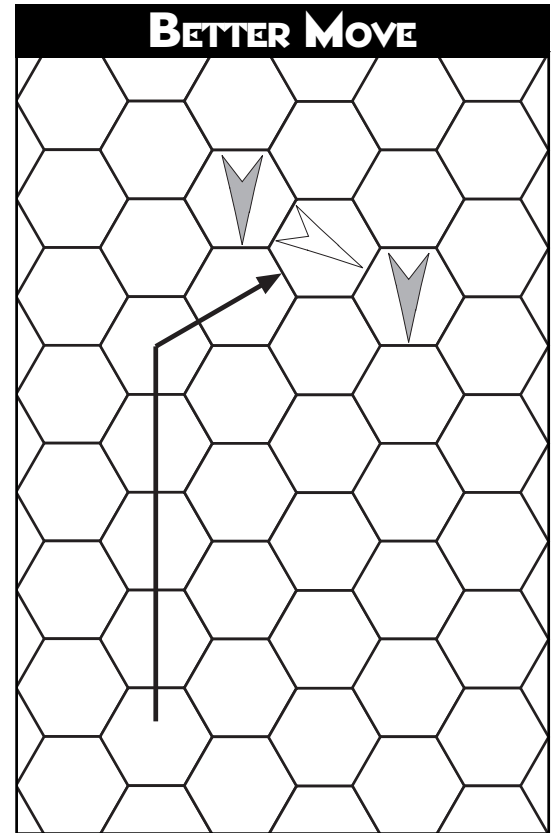

Weaponry Exercises

“Long training tends to make a man more expert in execution, but such expertness is apt to be gained at the expense of fertility of ideas, originality, and elasticity.”

—B. H. Liddell Hart, *Defense of the West*, 1950

1. The white torpedo is tracking the black fighter (see below). The fighter has just finished its move. Is it safe from the torpedo for this move?

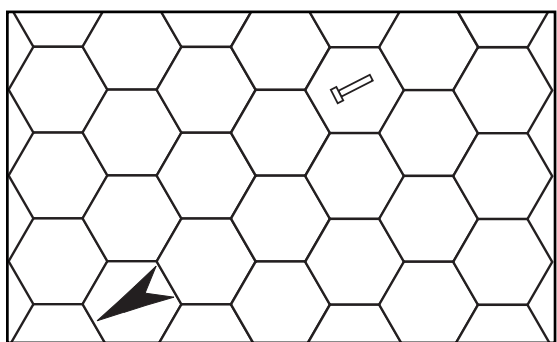

2. Your white fighter is being tracked by two black torpedoes (see below). The pilot has a piloting skill of 9. How can you get rid of the torpedoes over the next two turns without using decoys or any warheads of your own?
3. A gunner's attack die are $2D8 + 1D6$. The target has a defensive value of 14. What is the percent probability of scoring a hit?
4. Three Spirit Riders are closing in on a target, all are within firing range. Their percent probabilities for a hit are, respec-

tively, 50%, 38%, and 60%. What are the chances that the target will be hit by their attack?

5. Three Spirit Riders are attacking a Death Wind (defensive value 13). Two Spirit Riders have gunner skill 7, for a To Hit of $2D6 + 1D8$, and one has a skill of 9, for a To Hit of $2D6 + 1D10$. What is the expected damage? (Hint: A Spirit Rider's Splatterguns do Medium + 2 damage.)
7. You are shooting a Plazgun at a target with a defensive value of 16. Assuming you hit, how much damage can you reasonably expect to inflict on the target?

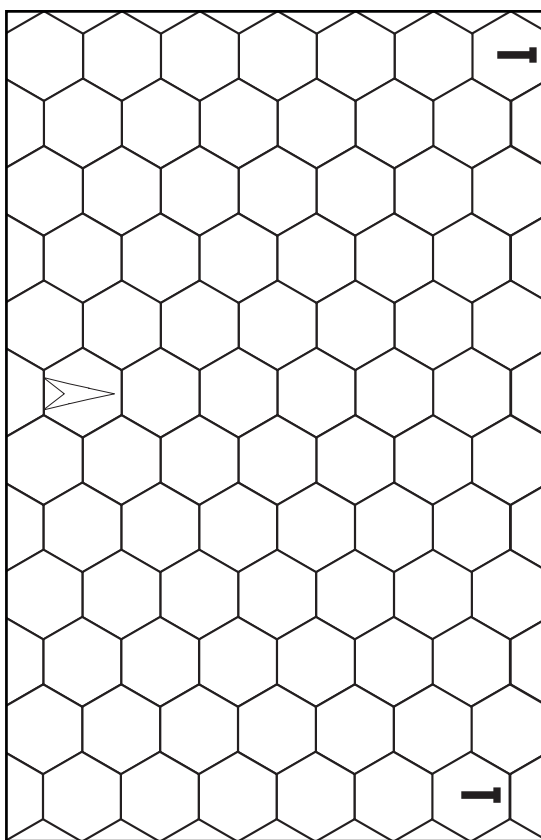

The Next Millennium

battery, Toini and her gunners all hit the Luches heavy fighter with all eighteen of the Splatterguns mounted on the ship, divided into two turret and one fixed battery. The Pharsii, normally a lethal and rugged opponent for anyone, came apart like a cheap tin can.

Within moments the Karelian flight had cut through the center of the Luches flight, reducing four perfectly good Pharsiis to so much ionized trash. Two of the Karelian ships had taken some damage, but while significant on one ship, it was nothing compared to the pandemonium that now reigned amongst

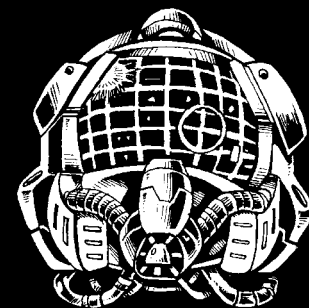

Silent Death

the Luches flight. Now divided into two separate groups, the Luches pilots seemed to hesitate about what to do, as if dazed by the virtually instant removal of one third of the entire formation and two thirds of their best ships!

Before the Luches pilots could regroup, the Karelrians had already turned around and pounced on one of the groups of three Salamanders and their lone accompanying Pharsii. As her second in command, Lt. Halbo, hit the Pharsii with his wingman, Toini and her wingman shared out their multiple six-gun batteries on the three



Situational Tactics

“Adherence to one principle frequently demands violation of another. Any leader who adheres inflexibly to one set of commandments is inviting disastrous defeat from a resourceful opponent.”

—Adm. C. R. Brown, USN., *The Principles of War*, June 1949

No manual can completely cover every situation you are going to face in a game. One reason is because such a manual would be too cumbersome to use. A better reason is because most situations do not have one and only one good solution. The idea is not to become rule-bound, but to learn to understand the dynamics of the game and use them to your advantage whenever and wherever you can. Every move you make should improve your situation, even if only marginally.

Throughout this manual we have stressed general principles along with some detailed study of the *Silent Death* game system, its structure and dynamics. Theory is one thing, using it in practice is another. There are several common situations that players encounter in the course of the average game or campaign. This section takes a look at some of these situations, with some of our thoughts on how to deal with them effectively.

Loss of Initiative

“If you are thoroughly conversant with tactics, you will recognize the enemy’s intentions and thus have many opportunities to win.”

—Miyamoto Musashi

Gaining the initiative at the beginning of every turn depends largely on the whim of the dice. Knowing how to move when you win initiative is easier for beginners than knowing what to do when you lose it. As a general rule, if initiative goes to the other player and you have to move your craft first, make the best of it by regrouping and reestablishing mutual support wherever you can. Sometimes it is a good idea to retreat to a safe distance in order to regroup. It may not sound like much of an option, but paying extra attention to things like mutual support can make your force harder to attack. Moreover, if your opponent gets overeager and allows his force to become dissipated, there will probably be some nearby stragglers that would be easy prey for a well-ordered formation.

Another thing to consider is that if the situation is looking unsalvageable, you may decide to get what force you have left off the board. In that case having to make the first move gives you a head start in your dash for safety.

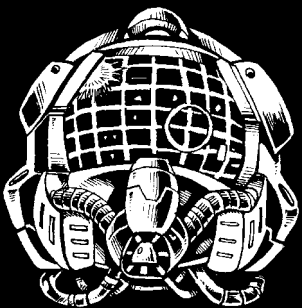

Finally, the presence of one really good pilot on the other side will naturally skew the initiative roll in favor of your opponent. If initiative is a critical factor in your battle plan, find a way to take out that pilot and reduce your opponent's chances to gain the initiative. Of course, that may be more trouble than it is worth, but if you have a choice between several ships, pound on the one you suspect has the best crew.

Coping With Battle Damage

"Hard pressed on my right. My center is yielding. Impossible to maneuver. Situation excellent. I am attacking."

—Ferdinand Foch, Message to Marshal Joffre, Battle of the Marne, 8 September 1914

If you have a choice, try to counter undamaged enemy craft with undamaged craft of your own. Using a significantly damaged craft against a similar, undamaged ship usually means sacrificing it. Keep your damaged ships together. Even if they move more slowly, at least they can maintain formation integrity.

In campaign rules, getting your damaged birds off the barbecue takes on greater significance. If you are playing campaign rules where ships can be repaired, you need to develop a sense of whether the mission has been blown and when it is time to save the remnants of your force. Pessimism or optimism can cloud your judgment in these kinds of decisions. Your best guide, as in most things, is experience.

Using Attrition Fighters

"It did not matter where we met, or how many enemy airplanes there were. We always attacked without consideration of chances or consequences. Our war cry was simply to shoot the enemy down...wherever and whenever!"

—Ilmari Juutilainen, Double Fighter Knight

As we mentioned before, "Attrition fighters" are the cheap fighters like Pit Vipers, Darts, and Blizzards. Beginning players often wonder whether there is a meaningful role for attrition fighters in a universe where ships keep getting bigger and nastier. If so, what is that role? What exactly do attrition fighters do, besides get blown up?

As the name implies, the attrition fighter is intended to wear the enemy down by exchanging several cheap ships in order to kill one or two larger, more expensive ones. Any war, and particularly a war of attrition, is often won or lost on the budget sheet. When your opponent can no longer replace losses, the game is yours. Using attrition fighters effectively depends on understanding how they work. First, you have to realize that attrition fighters are not really all that cheap. Their BPV cost is low individually, but if they are going to be any use, you need to buy them in droves. If you plan to go after big targets like heavy fighters or gunboats, you will lose ships, possibly a lot of ships. Start getting used to that idea right away if you want to use attrition fighters.

In theory, the advantage of attrition fighters is twofold. First, because they are supposed to heavily outnumber opposing ships, they have more opportunities to fire and more guns than the enemy. More guns means more chances to hit, and more chances to do damage. Of course, many attrition fighters carry weapons that do not inflict a lot of damage. If the target has a high damage reduction, the initial "hits" are likely to do little or no significant damage. Second, because attrition fighters are cheap, it is easier to bring your squadrons up to full strength between engagements. As we stated earlier, a good way to use attrition fighters is to stiffen them with a few ships that can hit hard enough to drop the defensive value of the target, then let the smaller, more plentiful guns complete the kill. Using a force consisting entirely of attrition fighters is usually not a good idea. Whatever you do, keep your attrition fighters together, focused, and fighting as a group. If you let them become scattered or spread their fire over too many targets at once they will be next to useless.

The Next Millennium

Salamanders which, under the Karelian's withering fire, came apart like so many cockroaches thrown into a blender.

Upon seeing their compatriots messy demise the remaining Luches pilots turned tail and ran back toward their lines as fast as their ships could accelerate, despite the visible damage to the new Karelian craft; it seemed that the new ships were rather weak in the armor department.

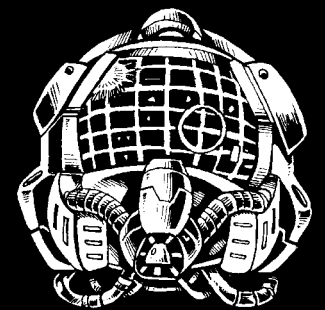

Silent Death

“Well, kids...” radioed Toini over her command frequency, “it looks like that nutcase of a designer got it right when he named these crazy things ‘Black Widows!’”

“Yikes!, What nasty itty, bitsy, spiders they are!”

Even dour Flight Sgt. Juutilainen laughed about Toini’s new name for her ship; ‘Itsy Bitsy Spider’ would be emblazoned across its flanks just as soon as Toini could round up her mechanic and his paint brush!

If you do not have enough attrition fighters to make a usable force, you can put them to work picking off stray torpedoes before they impact larger ships. This isn’t the most efficient way to use attrition fighters, but if a single attrition fighter can keep that one Mark 50 from nailing your gunboat or heavy fighter it can make like a big difference.

Fun With Gunboats

“Once at the enemy, you should not aspire just to strike him, but to cling after the attack.”

—Miyamoto Musashi

Ships with multiple damage tracks like gunboats are very intimidating opponents. They usually carry enough firepower to engage several smaller ships at once. Although slow, gunboats make a good rallying point. Move your seriously damaged fighters within the firing range of your gunboats to discourage your opponent from casually picking them off.

Gunboats are also good for taking on other gunboats, although you should not use gunboats in this role without fighter protection. Torpedoes are a threat to gunboats, since gunboats cannot dodge torps, and their slow speed makes it harder for them to get out of a well-timed torpedo’s kill zone.

Using Gunboats

“Impetuosity and audacity often achieve what ordinary means fail to achieve.”

—Niccolo Machiavelli, Discorsi, xlv, bk. 3, 1531

Generally speaking, gunboats have their heaviest firepower pointing out the forward arc. Since the idea is to concentrate firepower, lead with your forward batteries. The other weapons are designed to deal with the fact that gunboats are slow and easier for smaller ships to outflank.

When your gunboat is under attack, protect your rear quarter. This quarter typically has the shortest damage track. It also has earlier and more serious critical hits, and contains the majority of hits on the drive.

The rear quarter also tends to have lower damage reduction than the other quarters. If you are looking, for instance, at a heavy torp spread closing in on your “six” and you cannot get out of the way, consider turning the ship about and taking the hits on the front or side quarters. They can absorb more damage with fewer ugly side effects.

Attacking Gunboats

“There is no approved solution to any tactical situation.”

—George S. Patton, Jr.,
War as I Knew It, 1947

If you do not have any gunboats of your own, you will probably need quite a few fighters to ensure success. If you were paying attention during the preceding section, you already know the basic tactical doctrine against gunboats: concentrate your firepower against the rear quarter.

If you score some big hits using missiles, torpedoes, or other heavy weaponry on the backside of a gunboat you stand a good chance of success. Hitting the other quarters is not difficult, but doing significant damage is. There are a lot of empty damage boxes on those tracks. Even worse for an attacker is the fact that their damage reduction tends to be higher, and it takes quite a few hits to take down that damage reduction. If you gain the initiative, use your faster ships to get in behind for that all-important shot at the rear. It is possible to do this with torps, but difficult to ensure that they all hit the correct quarter. Since torp hits only strike the rear if the torps enter the target hex from the rear quarter, a gunboat only needs four drive points to pivot and take the hits on a more heavily protected side quarter.

One more point: use heavier torps against gunboats. A gunboat can shrug off a pair of Mk. 10s on the side damage track. But it is quite another matter when they’re Mk. 50s. Bigger targets demand bigger weapons.

Missile attacks on the rear quarter give slightly better odds of success. If the target enters a new hex during a turn when missiles are fired at it, chances are 50% (rolling a 4, 5, or 6 on 1D6) that your missiles will strike the rear quarter. If the gunboat has not moved to a new hex, missiles are targeted the same as cannon fire, so you can line up your

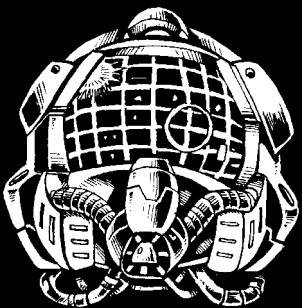

BAT**I.D.****BPV: 42**

TPV

Mk. 10 Torps

○
○
○
○

Pilot

2 Splatterguns (F)
To Hit: 2D6+ADB+1
Damage: Medium+2
Range: 2/6/10

Crew

PILOT
Plt: _____
Gnr: _____
Luck: _____
GUNNER
Gnr: _____

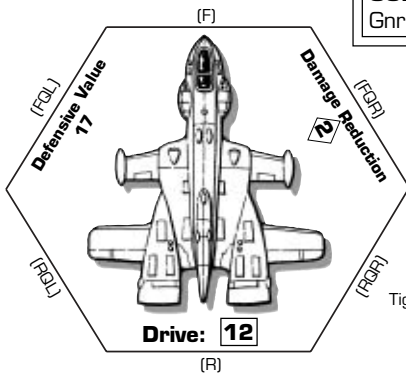

Tight Turn Cost: _____+3

Decoys: ○
P-D: —
Dmg Con: 1-2
Tons: 300

Gunner

2 Splatterguns
(RQL) (R) (RQR)
To Hit: 2D6+ADB+1
Damage: Medium+2
Range: 2/6/10

DAMAGE TRACK

→					12	t				10
	2	w	t	*	8				t	6
	1	w	*	t	4					×

BAT**I.D.****BPV: 42**

TPV

Mk. 10 Torps

○
○
○
○

Pilot

2 Splatterguns (F)
To Hit: 2D6+ADB+1
Damage: Medium+2
Range: 2/6/10

Crew

PILOT
Plt: _____
Gnr: _____
Luck: _____
GUNNER
Gnr: _____

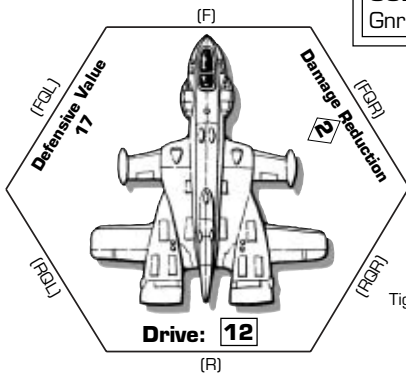

Tight Turn Cost: _____+3

Decoys: ○
P-D: —
Dmg Con: 1-2
Tons: 300

Gunner

2 Splatterguns
(RQL) (R) (RQR)
To Hit: 2D6+ADB+1
Damage: Medium+2
Range: 2/6/10

DAMAGE TRACK

→					12	t				10
	2	w	t	*	8				t	6
	1	w	*	t	4					×

CRITICAL HITS

- 2 — **Pilot killed.** Bat may perform no further actions. Defensive Value drops to 5.
- 3 — **Engines sputter.** Bat may only use 3 movement points next turn. Reduce Defensive Value by 6.
- 4 — **Electronic Warfare knocked out.** Bat may no longer jam torps. Reduce Defensive Value by 5.
- 5 — **Torps jettison.** Lose all remaining torps.
- 6 — **Pilot's Splatterguns damaged.** Reduce damage to Low+2.
- 7 — **Shields damaged.** Reduce Defensive Value by 2.
- 8 — **Gunner's Splatterguns damaged.** Reduce damage to Low+2.
- 9 — **Maneuver Thrusters damaged.** All turns, including tight turns, cost one extra movement point to perform.
- 10 — **Hull compromised.** Reduce Defensive Value by 4.
- 11 — **Gunner killed.** Gunner's Splatterguns may not fire.
- 12 — **Reactor hit.** Bat screeches to a halt, permanently.

SPLATTERGUN SPECS

Short Range: 1-2 hexes (+1 To Hit).
Medium Range: 3-6 hexes.
Long Range: 7-10 hexes (-1 To Hit).

GAME TURN RECORD TRACK

1	2	3	4	5	6	7	8	9	10	11	12	13	14	15	16	17	18	19	20
---	---	---	---	---	---	---	---	---	----	----	----	----	----	----	----	----	----	----	----

BLACK WIDOW

I.D. ■

BPV: 157

TPV

Pilot
6 Splatterguns (F)
To Hit: 2D6+ADB+5
Damage: Medium+10
Range: 2/6/10

Crew
PILOT
Pit: _____
Gnr: _____
Luck: _____
GUNNER A
Gnr: _____
GUNNER B
Gnr: _____

Decoys: ○○○
○
P-D: —
Dmg Con: 1-6
Tons: 1000

Mk. 10 Torps
○○○○○○
○○○○○○
○○○○○○

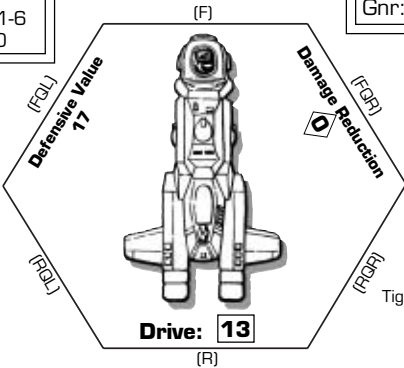

Gunner A
6 Splatterguns (360°)
To Hit: 2D6+ADB+5
Damage: Medium+10
Range: 2/6/10

Gunner B
6 Splatterguns (360°)
To Hit: 2D6+ADB+5
Damage: Medium+10
Range: 2/6/10

DAMAGE TRACK

							t					13		
		t					w	11	t	*				
			t			9							t	
			W	*	7	t								
		t	5						t				w	
*	3		t											t
1														

BLACK WIDOW

I.D. ■

BPV: 157

TPV

Pilot
6 Splatterguns (F)
To Hit: 2D6+ADB+5
Damage: Medium+10
Range: 2/6/10

Crew
PILOT
Pit: _____
Gnr: _____
Luck: _____
GUNNER A
Gnr: _____
GUNNER B
Gnr: _____

Decoys: ○○○
○
P-D: —
Dmg Con: 1-6
Tons: 1000

Mk. 10 Torps
○○○○○○
○○○○○○
○○○○○○

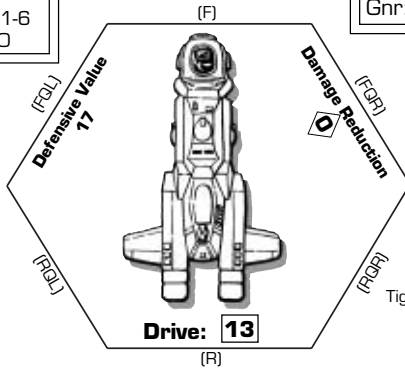

Gunner A
6 Splatterguns (360°)
To Hit: 2D6+ADB+5
Damage: Medium+10
Range: 2/6/10

Gunner B
6 Splatterguns (360°)
To Hit: 2D6+ADB+5
Damage: Medium+10
Range: 2/6/10

DAMAGE TRACK

							t					13		
		t					w	11	t	*				
			t			9							t	
			W	*	7	t								
		t	5						t				w	
*	3		t											t
1														

CRITICAL HITS

- 2 — **Pilot killed.** Black Widow may not move or fire pilot weapons. Reduce Defensive Value to 5.
- 3 — **Engines sputter momentarily.** Black Widow's Drive value is reduced to 2 until after next game turn.
- 4 — **Electronic Warfare knocked out.** Black Widow may no longer jam torps. Reduce Defensive Value by 3.
- 5 — **Splattergun Targeting damaged.** Reduce a random Splattergun's chance To Hit by 4.
- 6 — **Shields damaged.** Reduce Defensive Value by 4.
- 7 — **Gunner dazed.** One random gunner may not fire his weapon until after the next game turn.
- 8 — **Gunner A killed.** Gunner A's Splatterguns may not fire.
- 9 — **Splattergun Power Feed malfunctions.** Reduce random Splattergun's damage rating to Low+5.
- 10 — **Gunner B killed.** Gunner B's Splatterguns may not fire.
- 11 — **Torp load explosion.** Take 1D12 more hits for each remaining torp.
- 12 — **Massive structural collapse.** Black Widow buckles and explodes.

SPLATTERGUN SPECS

Short Range: 1-2 hexes (+1 To Hit).
Medium Range: 3-6 hexes.
Long Range: 7-10 hexes (-1 To Hit).

GAME TURN RECORD TRACK

1	2	3	4	5	6	7	8	9	10	11	12	13	14	15	16	17	18	19	20
---	---	---	---	---	---	---	---	---	----	----	----	----	----	----	----	----	----	----	----

SHARK

I.D. ■

BPV: 42

TPV

Pilot
1 Impulsegun (F)
 To Hit: 2D8+ADB
 Damage: High
 Range: 3/8/10

Crew
PILOT
 Plt: _____
 Gnr: _____
 Luck: _____

Pilot
1 Ion Ram (F)
 To Hit: 2D8+ADB
 Damage: All
 Range: 5/13/15
 Target SR ≤15

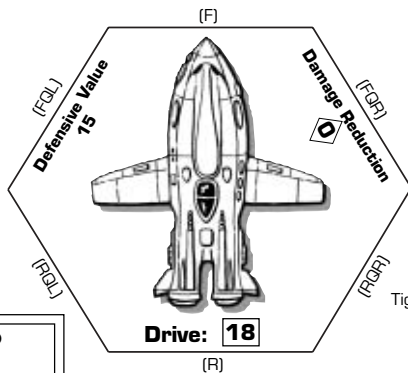

Tight Turn Cost: _____+3

Decoys: ○
 P-D: —
 Dmg Con: 1-2
 Tons: 300

DAMAGE TRACK

→			18			16			14	W
	*	12			10			8		W
	6	*	4			2				×

SHARK

I.D. ■

BPV: 42

TPV

Pilot
1 Impulsegun (F)
 To Hit: 2D8+ADB
 Damage: High
 Range: 3/8/10

Crew
PILOT
 Plt: _____
 Gnr: _____
 Luck: _____

Pilot
1 Ion Ram (F)
 To Hit: 2D8+ADB
 Damage: All
 Range: 5/13/15
 Target SR ≤15

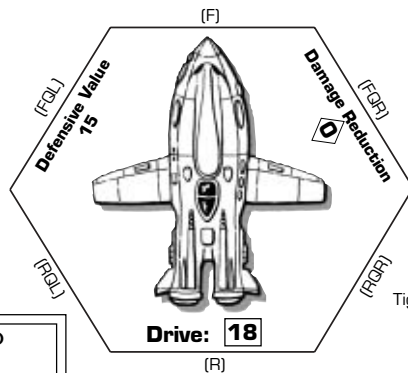

Tight Turn Cost: _____+3

Decoys: ○
 P-D: —
 Dmg Con: 1-2
 Tons: 300

DAMAGE TRACK

→			18			16			14	W
	*	12			10			8		W
	6	*	4			2				×

CRITICAL HITS

- 2 — **Pilot killed.** Shark may perform no further actions. Defensive Value drops to 5.
- 3 — **Engines sputter.** Shark may only use 3 movement points next turn. Reduce Defensive Value by 6.
- 4 — **Electronic Warfare knocked out.** Shark may no longer jam torps. Reduce Defensive Value by 5.
- 5 — **Maneuver Thrusters damaged.** All turns, including tight turns, cost one extra movement point to perform.
- 6 — **Shields damaged.** Reduce Defensive Value by 2.
- 7 — **Ion Ram damaged.** Reduce Damage to High.
- 8 — **Impulsegun Targeting damaged.** Reduce chance To Hit by 3.
- 9 — **Hull compromised.** Reduce Defensive Value by 4.
- 10 — **Severe structural damage.** Reduce Defensive Value by 6. Modify Shark's further To Hit attempts by -4.
- 11 — **Pilot dazed.** Shark may not move or fire until after the next game turn.
- 12 — **Reactor hit.** Shark is destroyed.

IMPULSEGUN SPECS

Short Range: 1-3 hexes (+1 To Hit).
 Medium Range: 4-8 hexes.
 Long Range: 9-10 hexes (-1 To Hit).

ION RAM SPECS

Short Range: 1-5 hexes (+1 To Hit).
 Medium Range: 6-13 hexes.
 Long Range: 14-15 hexes (-1 To Hit).
 Target Speed Restriction: Target's Drive value must be ≤15.

GAME TURN RECORD TRACK

1	2	3	4	5	6	7	8	9	10	11	12	13	14	15	16	17	18	19	20
---	---	---	---	---	---	---	---	---	----	----	----	----	----	----	----	----	----	----	----

CHUPACABRA

I.D. ■

BPV: 18

TPV

Pilot
1 Disruptorgun (F)
 To Hit: 2D8+ADB
 Damage: Medium §
 Range: 1/2/6

Crew
PILOT
 Plt: _____
 Gnr: _____
 Luck: _____

Pilot
Missile Launcher (F)
 Lock-on < _____
 ○ ○ ○ ○ ○
 ○ ○ ○ ○ ○
 ○ ○ ○ ○ ○
 ○ ○ ○ ○ ○

Pilot
Missile Launcher (F)
 Lock-on < _____
 ○ ○ ○ ○ ○
 ○ ○ ○ ○ ○
 ○ ○ ○ ○ ○
 ○ ○ ○ ○ ○

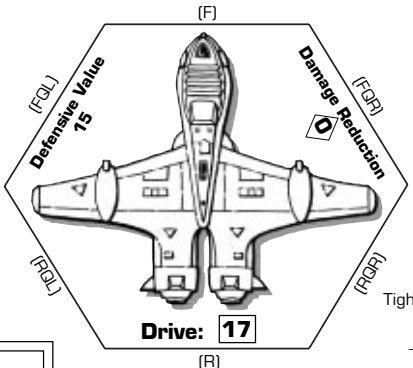

Tight Turn Cost: _____+3

Decoys: ○
 P-D: —
 Dmg Con: 1-2
 Tons: 100

DAMAGE TRACK

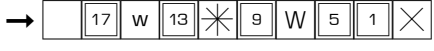

CHUPACABRA

I.D. ■

BPV: 18

TPV

Pilot
1 Disruptorgun (F)
 To Hit: 2D8+ADB
 Damage: Medium §
 Range: 1/2/6

Crew
PILOT
 Plt: _____
 Gnr: _____
 Luck: _____

Pilot
Missile Launcher (F)
 Lock-on < _____
 ○ ○ ○ ○ ○
 ○ ○ ○ ○ ○
 ○ ○ ○ ○ ○
 ○ ○ ○ ○ ○

Pilot
Missile Launcher (F)
 Lock-on < _____
 ○ ○ ○ ○ ○
 ○ ○ ○ ○ ○
 ○ ○ ○ ○ ○
 ○ ○ ○ ○ ○

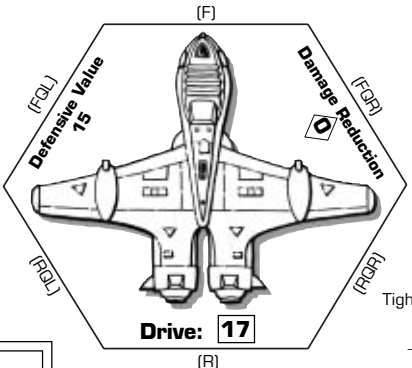

Tight Turn Cost: _____+3

Decoys: ○
 P-D: —
 Dmg Con: 1-2
 Tons: 100

DAMAGE TRACK

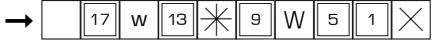

CRITICAL HITS

- 2 — **Pilot killed.** Chupacabra may perform no further actions. Defensive Value drops to 5.
- 3 — **One Engine destroyed.** Reduce current Drive value by half, ignore fractions. Reduce Defensive Value by 3.
- 4 — **Electronic Warfare knocked out.** Chupacabra may no longer jam torps. Reduce Defensive Value by 4.
- 5 — **Disruptorgun shorts.** Disruptorgun may not be fired until after next game turn.
- 6 — **Shields damaged.** Reduce Defensive Value by 2.
- 7 — **Disruptorgun Targeters damaged.** Reduce chance To Hit by 2.
- 8 — **Random Missile Launcher hit.** Launcher loses remaining missiles.
- 9 — **Forward Hull cracks.** Reduce Defensive Value by 3 and mark off 3 more hits.
- 10 — **One Engine sputters.** Reduce current Drive value by 3 until after next game turn.
- 11 — **Pilot dazed.** Chupacabra may not move or fire until after the next game turn.
- 12 — **Reactor detonates.** Chupacabra disintegrates.

[DISRUPTORGUN SPECS§]

Short Range: 1 hex (+1 To Hit).
Medium Range: 2 hexes.
Long Range: 3-6 hexes (-1 To Hit).
 § If the target's Defensive Value has not been reduced by a critical hit, add 1 to its Defensive Value. Also, completely ignore the target's Damage Reduction when resolving a hit.

GAME TURN RECORD TRACK

1	2	3	4	5	6	7	8	9	10	11	12	13	14	15	16	17	18	19	20
---	---	---	---	---	---	---	---	---	----	----	----	----	----	----	----	----	----	----	----

STINGER**BPV: 18****STINGER****BPV: 18**

TPV

Pilot
1 Splattergun (F)
 To Hit: 2D6+ADB
 Damage: Medium
 Range: 2/6/10

Crew
PILOT
 Plt: _____
 Gnr: _____
 Luck: _____

Mk. 40 Torps

Decoys: ○ ○
 P-D: —
 Dmg Con: 1-2
 Tons: 100

DAMAGE TRACK
 → [18] t [14] [10] * w [6] t [2] X

STINGER**BPV: 18****STINGER****BPV: 18**

TPV

Pilot
1 Splattergun (F)
 To Hit: 2D6+ADB
 Damage: Medium
 Range: 2/6/10

Crew
PILOT
 Plt: _____
 Gnr: _____
 Luck: _____

Mk. 40 Torps

Decoys: ○ ○
 P-D: —
 Dmg Con: 1-2
 Tons: 100

DAMAGE TRACK
 → [18] t [14] [10] * w [6] t [2] X

- ### CRITICAL HITS

 - 2 — **Pilot killed.** Stinger may perform no further actions. Defensive Value drops to 5.
 - 3 — **Torp Loads jettison.** Remove any remaining torp load.
 - 4 — **Electronic Warfare knocked out.** Stinger may no longer jam torps. Reduce Defensive Value by 3.
 - 5 — **Major Structural Damage inflicted.** Stinger takes 1D4 more hits.
 - 6 — **Shields damaged.** Reduce Defensive Value by 2.
 - 7 — **Splattergun Targeter hit.** Reduce chance To Hit by 2.
 - 8 — **Evade Thrusters hit.** Reduce Defensive Value by 4.
 - 9 — **Splattergun hit.** Weapon may no longer be fired.
 - 10 — **Engines damaged.** Stinger reduced to a Drive value of 1. Reduce Defensive Value by 6.
 - 11 — **Pilot dazed.** Stinger may not move or fire until after the next game turn.
 - 12 — **Reactor hit.** This Stinger's been swatted.

SPLATTERGUN SPECS

Short Range: 1-2 hexes (+1 To Hit).
 Medium Range: 3-6 hexes.
 Long Range: 7-10 hexes (-1 To Hit).

STANDARD RULES TORPEDO KILL ZONE

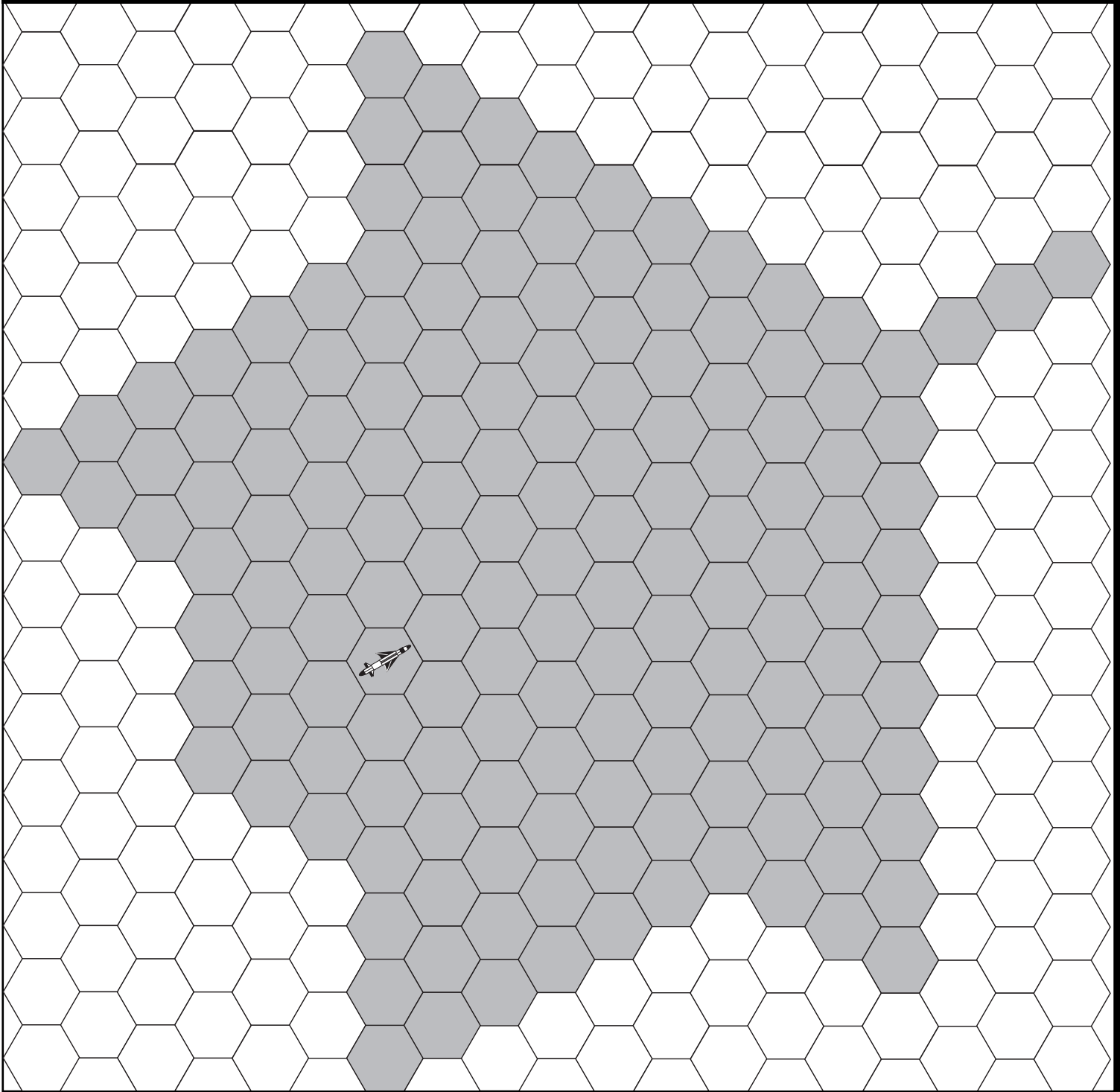

VARIABLE SPEED TORPEDO KILL ZONE

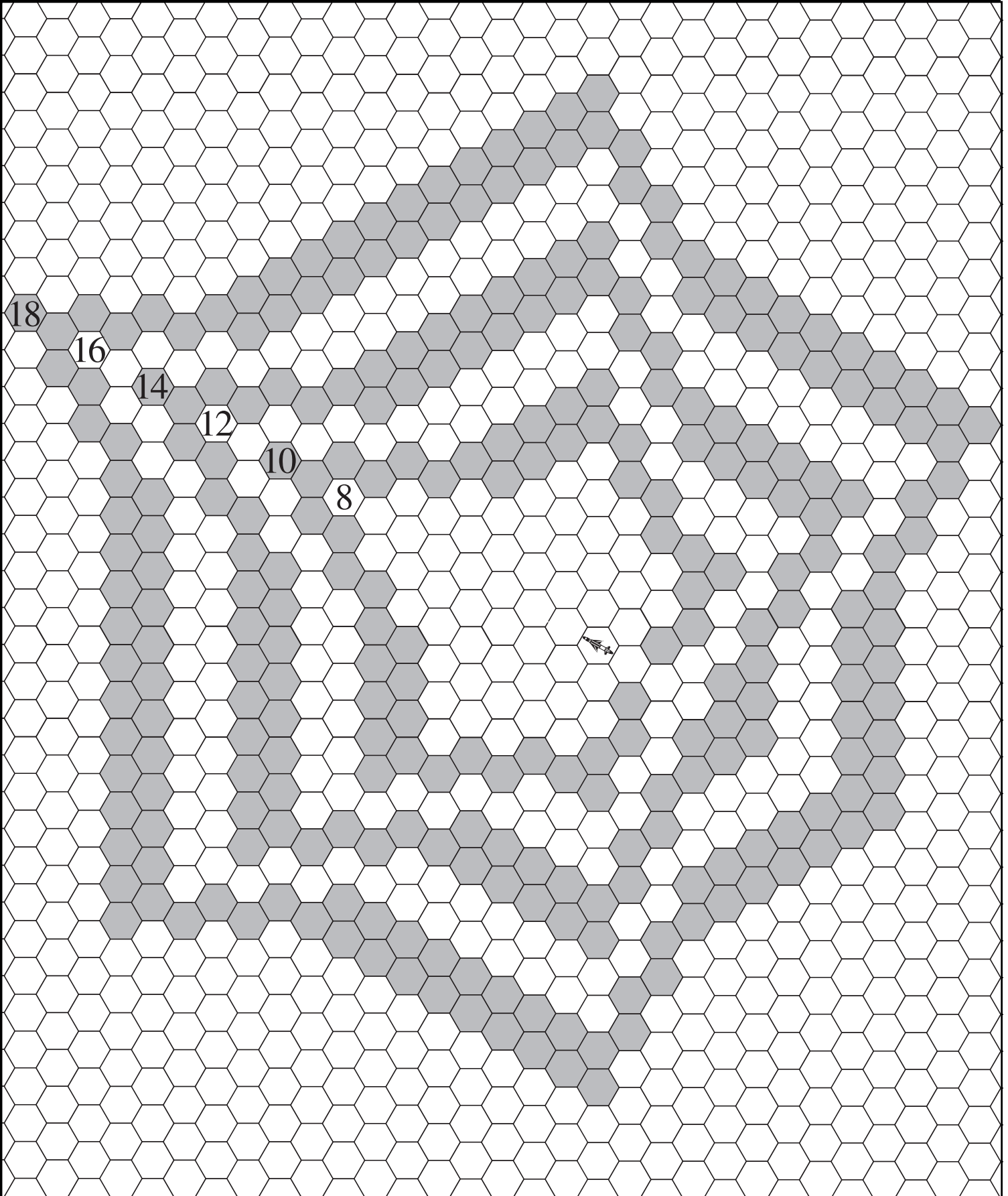

VARIABLE SPEED MANEUVERABLE TORPEDO KILL ZONE

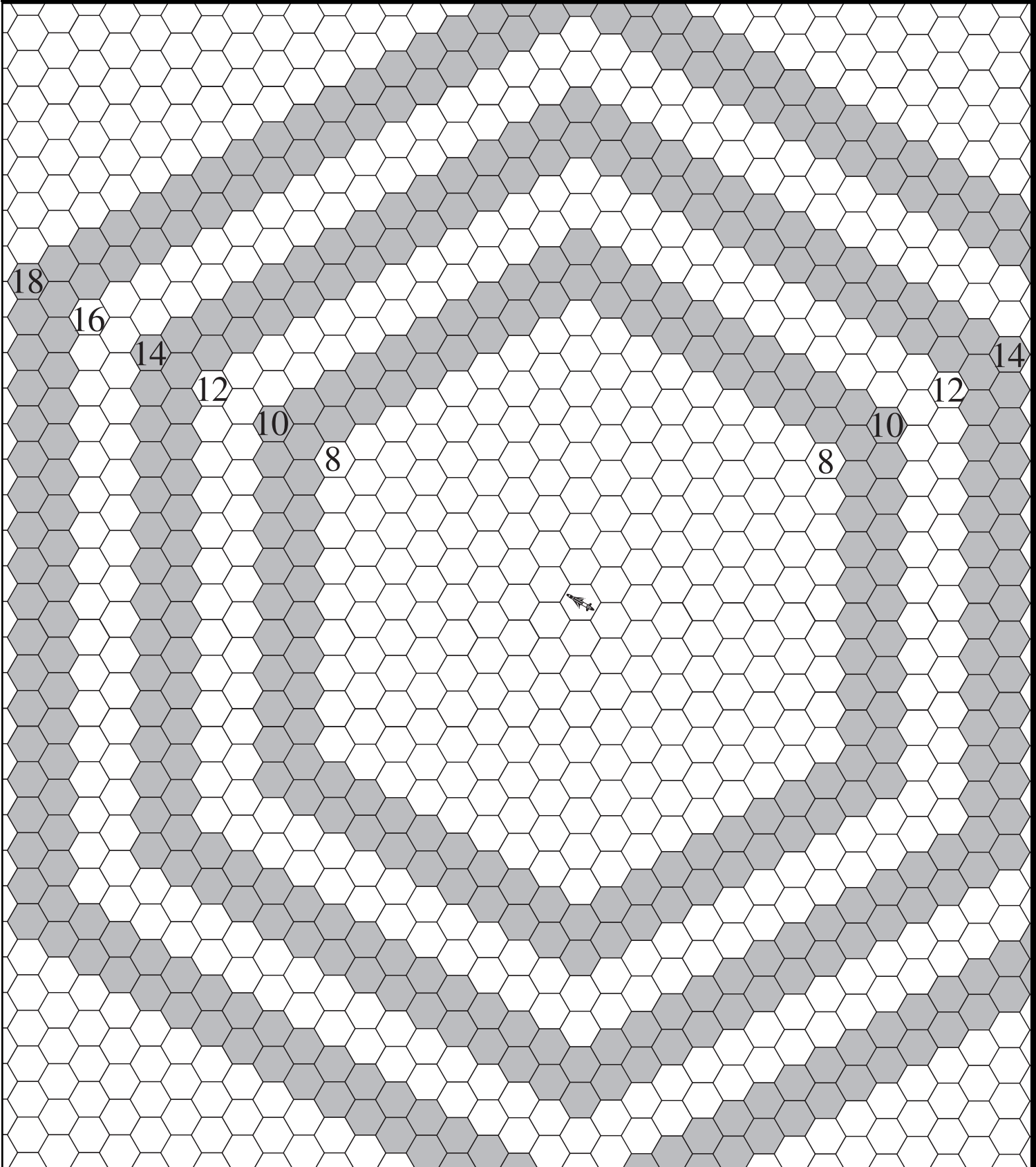

Silent Death

Torp Costs								
Mk.	Number	Base Cost	VS Cost	SM Cost	VSSM Cost	VS Upgrade	SM Upgrade	VSSM Upgrade
Mk. 10	1	1	3	3	6	2	2	5
	2	2	6	6	12	4	4	10
	3	3	9	8	18	6	5	15
	4	4	12	11	24	8	7	20
	6	6	18	17	36	12	11	30
	10	10	30	28	60	20	18	50
Mk. 20	1	2	4	6	9	2	4	7
	2	4	9	11	19	5	7	15
	3	6	13	17	28	7	11	22
	4	8	18	22	38	10	14	30
	6	12	26	34	56	14	22	44
	10	20	44	56	94	24	36	74
Mk. 30	1	3	4	8	11	2	5	8
	2	6	9	17	22	3	11	16
	3	9	14	25	33	4	16	24
	4	12	18	34	44	6	22	32
	6	18	27	50	67	9	32	49
	10	30	45	84	111	15	54	81
Mk. 40	1	4	4	11	11	0	7	7
	2	8	8	22	22	0	14	14
	3	12	12	34	34	0	22	22
	4	16	16	45	45	0	29	29
	6	24	24	67	67	0	43	43
	10	40	40	112	112	0	72	72
Mk. 50	1	5	3	14	10	-2	9	5
	2	10	6	28	20	-4	18	10
	3	15	9	42	30	-6	27	15
	4	20	12	56	40	-8	36	20
	6	30	18	84	60	-12	54	30
	10	50	30	140	100	-20	90	50
Mk. 60	10	60	18	168	60	-42	108	0
Mk. 70	10	70	21	196	70	-49	126	0
Mk. 80	10	80	24	224	80	-56	144	0
Mk. 90	10	90	27	252	90	-63	162	0
Mk. 100	10	100	30	280	100	-70	180	0

Alternative Torpedo, Warhound, Satellite, & Outpost Costs				
Ship	Base Cost	VS Cost	SM Cost	VSSM Cost
Aosho	764	762	1034	962
Constellation	806	768	1040	930
Fletcher	894	918	1038	1018
Longboat	921	922	1173	1133
Megafortress	482	526	536	606
Narwhal	623	682	731	828
Stingray	551	599	623	699
Taurus	41	41	84	84
Octopus	42	76	82	136
Dauntless	391	391	403	463
TBD Platform	210	210	253	253
Wakazashi	260	320	314	410

Alternative Torpedo Ship Costs

Ship	Base Cost	VS Cost	SM Cost	VSSM Cost
Avenger	78	108	110	158
Bat	42	50	49	62
Betafortress	216	291	293	295
Betafortress Alpha	218	292	295	297
Betafortress Beta	220	295	297	299
Betafortress NW	160	180	178	210
Black Widow	157	177	175	207
Blizzard	19	27	26	39
Blizzard II	18	26	25	38
Catastrophe	142	176	182	236
Conestoga	215	223	242	256
Crescent	55	65	64	80
Death Wind	60	70	74	90
Death Wind II	64	74	78	94
Drakar	121	125	125	131
Drakar Alpha	125	133	132	145
Eagle	170	198	215	261
Epping	119	125	141	151
Epping NW	119	125	141	169
Equalizer NW	123	143	141	173
Firebat NW	57	77	75	107
Glaive	106	106	120	120
Glaive II	107	107	121	121
Glaive III	104	104	118	118
Hammer	60	78	81	110
Havok	59	67	66	79
Hell Bender	32	35	37	40
Hell Bender II	33	36	44	55
Hell Bender K	26	31	33	41
Hornet NW	97	127	124	172
Hound	19	24	26	34
Iceberg	207	230	261	300
Javelin NW	131	151	149	181
Karttikeya	150	174	186	224
Lakshmi	83	91	90	103
Lance Electra	60	67	75	86
Lance Electra II	60	67	75	86
Marut	15	21	20	30
Nemesis	298	318	424	448
Pharsii	110	116	118	127
Pharsii II	120	126	128	137
Pit Viper	17	22	28	33
Praying Mantis NW	167	187	185	217
Rattler NW	70	90	88	120
Revenge	120	100	210	170
Revenge II	120	100	210	170
Salamander	66	76	77	93
Salamander II	66	76	77	93
Salamander NW	67	75	74	87
Scorpion	122	130	158	171
Seraph	121	127	137	146
Seraph II	121	127	137	146
Sorenson II	47	63	66	92
Sorenson III	68	84	95	115
Spider	129	163	169	223
Spirit Rider	18	22	22	28
Spirit Rider II	17	19	21	24
Star Raven	125	131	157	165
Star Raven Alpha	128	141	153	174
Stinger	18	18	32	32
Talon	33	35	35	38
Talon II	38	46	45	58
Teal Hawk	43	45	45	48
Teal Hawk II	47	55	54	75
Teal Hawk NW	50	52	52	55
Thunder Bird	25	35	36	52
Thunder Bird II	24	32	31	44
Thunder Bird NW	32	40	39	52
Varuna	120	132	131	150

The Next Millennium

shots accordingly, unless the gunboat rotates without leaving the hex. To help increase your chances, attack with several missile-carrying fighters simultaneously.

Of course, not every situation will give you the opportunity of a clear shot at a gunboat's rear. In that case, pick one convenient quarter and concentrate exclusively on that quarter. It might take a little longer, but if you fill the entire damage track for any one gunboat's quarter, it destroys the target. One downside is that concentrating fire on the front or sides usually does not reduce the drive of the target very much. On the other hand, as the weapons protecting the targeted side are removed, that quarter becomes increasingly vulnerable. Side quarters also cover two hex faces instead of one, meaning you have a greater area from which to pile it on.

Fighting With Inferior Numbers

"Their force is wonderful, great and strong, yet we pluck their feathers by little and little."

—Sir William Howard, Of the Spanish Armada, 1588

Nobody likes to be outnumbered or outgunned. Our advice to you is, assuming you have a choice, do not engage superior forces unless you have a compelling reason to expect success. Campaign scenarios make the option of running from a bad situation more useful, being outnumbered can be less troublesome than it would be in a regular "fly 'til you die" game.

If you must work with smaller forces, remember that the key is local superiority. A simple but effective tactic is to move in fast or let the enemy get close, concentrate what fire you can on one or two easy targets, and get the hell out of Dodge before your opponent can react. Do not let the temptation of a major upset lure you into sticking around. Decide in advance on a modest objective that can be accomplished in two turns, three tops. Do not wait any longer to clear out or you will probably lose what forces you have.

When attacking a larger force, try to "nibble at the edges." Hit ships that are closest to your ships. This helps you stay

away from the bulk of the enemy's firepower, especially if you manage to cripple or destroy the ships you attack on the first or second turn. Of course, if the heavier, more expensive ships are in the middle of the formation, you will not have time to do more than throw your remaining torpedoes at them as a parting shot. You will not be able to do very much during a given engagement, but losses accumulate. Winning against superior numbers in a campaign setting is a long-term problem. It takes time to carry it off successfully. Do not be impatient. Keep nibbling, and with luck eventually those heavies will not have any escort fighters to support them. When that happens, it's party time!

If you have the luxury of knowing ahead of time that you will be using hit-and-run tactics, this should influence your choice of ships. As we mentioned in the chapter on weapons, missiles are a good choice for this kind of combat because they can be used before the movement phase and cannon phase. This lets you wait for the enemy to close, release a volley of missiles, and move beyond range of a counterstroke unless your opponent is also using missiles. Releasing a few torpedoes in addition to the missiles will help discourage pursuers while you run for it. Torpedoes can effectively increase the size of your fleet by tying up other ships as they try to evade, dodge, or shoot down your torpedoes.

Using Elite Forces

"The forces sent first to confront the enemy are normal ones, and sent later to attack the enemy are extraordinary ones."

—Wei Liaozi, Sung Dynasty scholar

Most people would not think of this as a tactical problem, but by their very nature exceptional units can play by slightly different rules. That is what makes them elite. The last thing you want to do is use them in the same, tired old ways. If they have superior gunnery, they can do damage quicker and from further away. A unit with edge-of-the-envelope speed and piloting skills can blow past the escorts as they close to engage, and get at least one relatively undistracted shot at the big juicy targets the escorts were protecting. Of course this

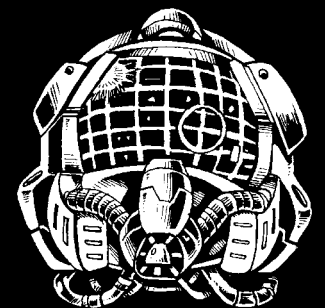

Silent Death

violates the guideline we gave earlier about “nibbling at the edges,” but that’s precisely the point. If you have units that are out of the ordinary, you must force yourself to think of unconventional ways to use them.

It is also important to be careful how you use less stellar units. Mediocre or poor units are good for harassing the enemy or creating a diversion. You do not need to be brilliant to just drop your torps and run. Average units are generally fine for engaging opposing line units in order to inflict a few losses, disrupt their formation, and get the opponent to commit as much of his force as possible. Then, when everything is one big fur-ball, send in the cream with a clear target or objective. Very often this is what swings the momentum of a game or campaign solidly in your favor.

Diversions, Traps, and Feigned Retreats

“The nature of water is that it avoids heights and hastens to the lowlands... Now the shape of an army resembles water. Take advantage of the enemy’s unpreparedness; attack him when he does not expect it; avoid his strength and strike emptiness, and, like water, none can oppose you.”

—Chang Yu, c. 1000

A good tactician controls the flow of the game. Creatively distracting the other player’s attention with a diversion is one way to do this. However, if you want to entice the other player to come after you, you need to do more than just sit out there and hope you look vulnerable or threatening. You have to make such a nuisance of yourself that you will look like a serious threat, or look helpless enough to look like a genuine opportunity. Of course, the really clever tactician can turn the diversion into the real punch if the opponent becomes open or vulnerable to it. Do not forget to make allowances for unforeseen opportunities when you formulate your battle plan.

Another good surprise ploy is the tactical retreat. Suppose you are locked in battle, with neither of you gaining any significant advantage. Both of you have taken

damage. Your damaged ships start heading the other direction, followed by your faster, intact vessels. Suddenly your whole fleet is in retreat across the board!

Smelling victory, your opponent pursues at top speed. The faster ships begin to outstrip the slower, damaged ones. If you play the stratagem well, you can string out the enemy formation. That is when you turn and strike! If you are careful, you will have kept your force together. Turn the brunt of your entire fleet on the ships leading the pursuit. If you can cripple or destroy them quickly, you can continue to roll up the enemy fleet, which is too spread out to react concertedly. Use this technique to break a deadlock or wrap up a victory. If you are more battered than the other player, this ploy probably will not save you. The Mongol cavalry frequently employed this tactic, but they used it only when they knew they were in a position to win.

As an additional twist, if the rules allow you to bring extra forces onto the board during a game, sucker your opponent over towards your side of the board just in time to meet new, fresh fighters emerging from your border.

Situational Tactics Exercises

1. You must select a small strike force of four fighters to launch a hit-and-run attack. You know that the target will be a pair of Revenge heavy fighters. You have the choice of using four Death Winds or four Lance Electras. Which should you use, and why?
2. Your fleet includes four Night Hawks and six Spirit Riders. You want to use the Spirit Riders to feint towards the enemy flank. How can you make the feint more effective?
3. Three Night Hawks are trying to get back to the rest of the fleet. Two of the Night Hawks have moderate to heavy damage. The third is unhit. As they attempt to regroup with their fleet, an undamaged Teal Hawk moves in to try to keep them away from their fleet. Assuming you want two of the ships to get to the fleet while the third deals with this threat, which Night Hawk should you use?

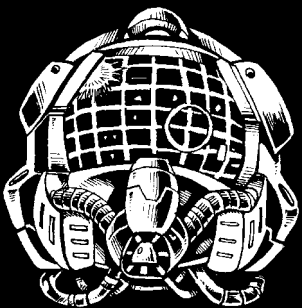

4. You need to select a gunboat from the choices listed in the rulebook for *Silent Death: The Next Millennium*. The mission profiles will be short, hit-and-run actions. The choices are the Drakar, Star Raven, Epping, and Betafortress. What is your choice?
5. A flight of Talons is two turns into a messy dogfight with your squadron of Hell Benders, when you blow the initiative roll. Casualties and damage are about even. You have to start moving ships first. What should you try to do this move?

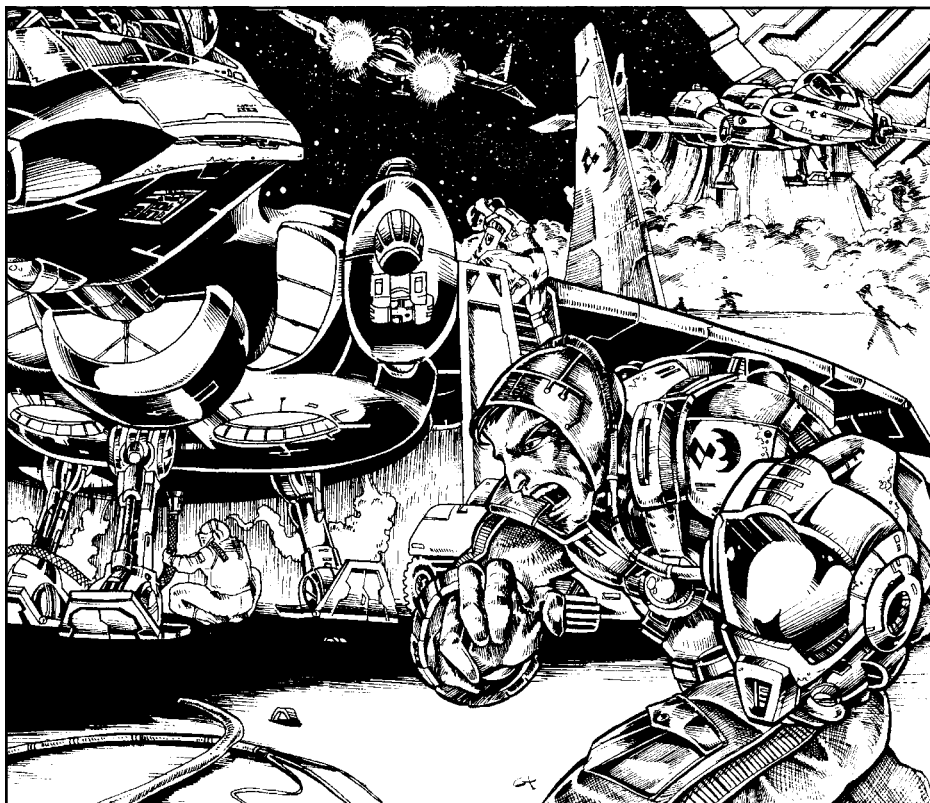

Campaign Tactics

“I rate the skillful tactician above the skillful strategist, especially him who plays the bad cards well.”

—Sir. A. P. Wavell, *Soldiers and Soldiering*, 1939

When we talk about tactics, we are usually talking about how to win a game. A campaign is a sequence of games where the outcome of each game has an impact on the next one. How do you win a campaign? One game at a time. Of course, some things are going to be different. For one thing, most campaigns involve an umpire, that is, a non-player who controls the flow of action and information, and manage problems like hidden movement and other optional rules requiring a trusted third party. A good umpire can make all the difference. For that matter, so can a poor one. Good

umpires that can also design good scenarios are especially to be prized and treated to dinner occasionally. If the campaign is well-designed, you will be facing a wider variety of situations than you would in a single game. You must assemble your forces carefully because you will be stuck with them for the whole campaign.

You also have the option to upgrade your crews with experience rules. Repairing and replacing ships also becomes possible, so you have more incentive to make sure everyone gets home safely. Naturally, the principles of teamwork, concentration of firepower, careful planning, and everything else we have discussed in this book are just as important. If you payed attention, you should do well. What follows are some hints that are especially germane to campaigns, but apply to regular games as well.

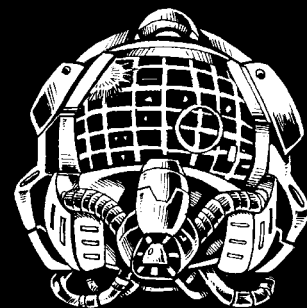

Assembling Your Flight Crews

"All men from 15 to 70 years of age are ordered to come: not even a monkey tamer will be let off."

—excerpt from mobilization orders issued by Hojo Ujimasa cir. 1560

If you are participating in a campaign, you probably will not be able to staff all of your ships with the best of the best. You will have to make some concessions in order to deploy enough ships to do the job. The problem involves the trade off between lots of average pilots and a few really good ones. Some fighters or mission profiles do not need ace pilots. You may need some pilots flying Blizzards or Thunderbirds and all you need them to do is wait on the fringes, drop their torpedoes at the right moment, and head back to the barn. Other pilots who fly superiority fighters or will face torpedo barages will need outstanding piloting skills.

Purchasing gunnery skill presents different problems. Obviously, buying better gunnery will result in higher to hit percentages. But are 4 fighters whose pilots each have a 25% chance to hit as good as 2 with 50%? In other words, are the points spent on the latter more cost-effective than the former? In one respect, higher quality pilots are a better value; they give you a higher percentage to hit per BPV point spent on gunnery skill. However, you have more to lose if a good pilot or gunner goes down. Suppose you have 2 pilots, each with a 50% chance to hit a given target, or 4 pilots each with a 25% chance. If you lose one of the first group, the remaining pilot only has a 50% chance of hitting. If you lose one of the second group, the survivors still have a collective 58% chance of hitting. High quality pilots or gunners give you more punch per point, but at a cost of formation depth and redundancy.

Another useful thing you can do for your units is to keep the skills more or less consistent. In other words, it is better for your pilot skills be consistent in a particular group than for you to have one or two standouts and the rest mediocre. This is why: imagine you have a flight of four ships with pilot skills of 9, 10, 4, and 5. Suddenly,

your flight gets targeted by a nearby Blizzard, who launches a spread of four torpedoes. The Blizzard directs one torp at each ship. For half the pilots in the flight, this is not a serious threat. In addition to the usual countermeasures, the better pilots have 80% and 90% chances, respectively, of dodging a single torp. For the weaker fliers it is a different story. Their odds are 30% and 40%. Not nearly as good.

As the commander of this intrepid flight, you face a troublesome decision. Do you fly on and hope that the weaker pilots will get lucky dodging rolls? Probably a bad idea. Do you exercise caution and try to evade while keeping your flight more or less together? This is safer, but will probably force you away from your objective. Finally, you can let the weaker pilots evade, and the better pilots try to dodge. The big drawback with this option is that it splits your formation. Your best pilots press on while the weaker ones struggle to stay one step ahead of the torps. In effect, that pesky Blizzard has succeeded in cutting your force in half without scoring a single hit! Also, by splitting your formation, each half becomes an inviting target for opposing formations to cut off and blow away at their leisure.

If all the pilots in the formation had more or less the same level of skill, this decision would not be so difficult to make. A sound response would be more obvious, and you would be less tempted to break up the group. True, the formation may have to evade rather than press on, but at least they would do so as a group. With formation integrity intact they are more of a threat than they would be as solitary ships scattered across the board. As suggested earlier get as many of the best pilots as you can afford, but keep them working together. You will want them around for the advantages they bring to the initiative roll. Do not bog them down by putting them with mediocre crews. Put them with the elites where all of them can shine!

As with most rules, there are exceptions. At the beginning of each turn both sides dice for initiative. The roll is added to the highest piloting skill on that side. Obviously one exceptional pilot helps you during the initiative phase. It certainly helps to have one elite pilot in a group of average fliers. Just do not lose that pilot!

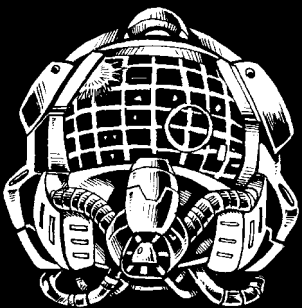

Building Squadrons That Work Together

"We must remember that one man is much the same as another, and that he is best who is trained in the severest school."

—Thucydides, History of the Peloponnesian Wars, I, c. 404 BC

One common mistake is for someone building a fleet or task force to pay through the nose for a bunch of really hot ships and crews, then try to stretch the remaining budget by purchasing cheap, undependable units. Do not fall into this trap. Build each part of your fleet with the whole in mind. Try to create consistency across the working units of your fleet.

One way to do this is to assemble squadrons using ships with similar drives. Remember the definition of "flank speed": the top speed of the slowest ship in a convoy. Your task force can only move as fast as its slowest vessel. Try to keep the speed differential between working units below three drive points. If speed difference is too high, it might be too tempting to divide or scatter your forces, and that is usually not a good idea. We are not advocating that you only use fast ships, just keep your ships working with allies of similar speed whenever possible. Try not to make slow ships work with (or against!) fast ones, unless you have a good reason to expect success. If you need to use ships with widely differing drives, make sure the ships of the different speed classes can get help from other ships of similar speed. Or, simply exercise enough discipline not to let your faster ships leave your slower ones behind in the excitement of battle.

The same problem applies to defensive values. If you have a mixed task force, you may find yourself unwilling to commit all of the force against a difficult target if some of your ships are especially vulnerable. Some ships, like attrition fighters, are vulnerable practically by definition so plan to lose a few. But if you do not intend to use your ships in an attrition role, keeping the DV consistent in your formation helps simplify many tactical decisions.

Choose Your Weapons

"Bold decisions give the best promise of success."

—Erwin Rommel, Rules of Desert Warfare

The *Silent Death* player has a wide selection of choices when it comes to weaponry. As we mentioned earlier, a mix of weapons is a good idea, especially when the nature of your mission is unknown. Every weapon type has drawbacks, and situations where it does extremely well. We offer the following thoughts on making sound choices when you shop for weaponry, or when you are selecting weapons for ship designs.

Do not just consider the amount of damage a weapon will do when choosing weaponry. A Plazgun usually does more damage than 6 Splatterguns on any given hit, but it's harder to hit with one, since the 6 Splatterguns have that +5 to hit. Over the course of an average game, you will probably do more damage with the Splats.

Other weapons like torpedoes, Ion Rams, Meld Lasers, and Railrepeaters, are good for hitting something at a distance. Unfortunately, these weapons have speed limitations and cannot track fast targets. Still, if you know you're going to be hunting slow gunboats or freighters, use things that allow you to get in an extra punch before other short-range weapons get close enough to count. When you're doing hit-and-run tactics against large, heavy targets, a long reach can render some escort fighters superfluous until they close, and by then you can be long gone. A Turbo Laser can open up on a slow-moving Betafortress at a range of 30 hexes and do high damage at -1 to hit. Not bad, especially when you consider that it could take your opponent some time to bring faster escorts ships up to deal with your attack. And how long would it take the Betafort to plod close enough to hurt you? This would be an interesting way to draw off the escorts of a slower ship. If you play it well, you can either chew up the unsupported escorts or pounce on the unescorted gunboats. It may also force your opponent to deploy the escorts further out from their charges to prevent long range attacks, and thus rendering both escorts and gunboats even more vulnerable to isolation.

The Next Millennium



Silent Death

Do not just purchase big, nasty weapons. Subtlety counts for a lot in many tactical situations. Some smaller weapons have unexpected and underappreciated advantages. For example, disruptors give an edge to smaller attrition fighters, because you do not need heavier guns to break down a target's damage reduction before the little ships can go to work. Although they have some disadvantage in hitting initially, Disruptorguns bypass the damage reduction, so their mischief adds up suprisingly fast. Study the quirks of each weapon type and compare them with your needs and the weaknesses of other ships before you assemble your squadrons.

Keeping the Mission in Mind

"When reaching a stalemate, win with a technique the enemy does not expect."

—Miyamoto Musashi

As in real-life air forces, squadrons should be created for different kinds of missions. Your goal will dictate the kinds of ships you group together. Are you going to adapt an attrition strategy? Pick ships that work well in that strategic role. Will you be hunting larger prey? Decide whether you want to strike from afar or get "up close and personal" when you choose your ships.

Do not forget to think about who might try to stop you. If you go after a convoy with a task forced all tooled up to pound slow-moving lugnuts, imagine your surprise when your opponent puts a fast-moving superiority squadron between you and your erstwhile prey. In that case, you are probably in very deep trouble, unless you brought along your own squadron of superiority fighters.

When you choose your forces, it helps to specify your goals, then break those goals down into steps. For example:

Step one: Neutralize the convoy's covering force.

Step two: Engage and destroy cargo vessels.

Step three: Disengage and retire.

Maybe you can do all of this with a group of strike fighters, or perhaps you would prefer superiority ships. Attrition fighters

may take too long if the job needs to be done quickly, however their higher speeds make a quick getaway possible. Think each step through carefully. Make sure the ships you choose can do what you need them to do at every step of the engagement. Make notes after and even during your games and incorporate your insights into the formation and adjustment of your own fleets and task forces. Specifying your objectives will also help you keep your mind on the mission.

Intelligence Gathering

"There exists a small number of fundamental principles of war, which may not be deviated from without danger, and the application of which, on the contrary, has been in all times crowned with glory."

—Jomini, Précis de l'Art de la Guerre, 1838, Campaign Tactics

During the average game, most players engage in intelligence gathering that goes something like this: "Oh, look. I am about to get splatted by four Night Hawks closing on a quarter that I am defending with one Pulse Laser." That kind of intelligence report ranks right up there with "Sir, we have hit an iceberg!" or "Someone is bombing Pearl Harbor" or "I tot I taw a puty tat." It is useless information because it is too late to be of any use.

Short of bugging your opponent's house (which we do not recommend), we strongly suggest you do whatever you can within the bounds of reason, game rules, general sportsmanship, the law, and the tenets of good taste, to learn how your opponent conducts a campaign. If you have seen this person play a game or two, you may already have enough information to develop some idea of what to expect.

If you are denied this kind of intelligence, you are left with what you can learn during the game. Not to worry. There are ways to probe your opponent's intentions. Campaigns often use rules that keep the size, location, composition, and objective of each side's forces a secret. This is one area in which a referee or umpire can be critical

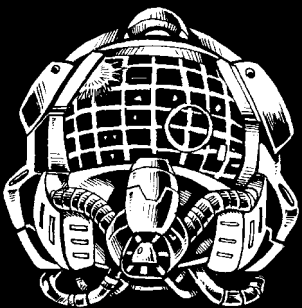

to simulating the “fog of war” by carefully controlling what each side knows about the other. As a player, you have other sources besides the referee. Your objective as a “spook” is to learn all you can about the forces arrayed against you while disclosing nothing of your own order of battle. Start by using fast ships to scout and probe, trying to provoke a response. Entice the enemy into pouncing on your scouts and thus show you what kinds of forces he is using. Look for responses that are disproportionate to the provocation. Well-designed campaigns generally have objectives more subtle than “kill the other guys.” A good campaign design can even involve objectives that are not necessarily exclusive on the surface. If you threaten the attainment of an opponent’s objective, your opponent will react accordingly. Build a profile of your opponent’s responses. Learn what kind of move is likely to be ignored, or responded to with extreme prejudice. Use these facts to inform your deployment and strike with unexpected and overwhelming force. As we stated earlier, you must know your enemy.

Sudden, unexpectedly harsh responses to a probe are instructive. Reasons for a strong reply to a scout or probing raid include:

- a) Hiding something important.
- b) Preparation for a major assault.
- c) A bloodthirsty attitude itching to kill something.
- d) Desperation.

In the case of the first two, clearly something is waiting to be disrupted. If you stumble onto a way to block your opponent’s objective, chances are you now know where to mass your forces and where to strike. Your next step is to strike hard, keep your opponent stymied, and quite possibly win the campaign. If a major build-up is in the works, this is a great opportunity to strike before your opponent is ready. Do not wait around for the attack. Take the fight to the enemy when he is still unprepared. Incidentally, if your plan of attack is simple and straightforward, you will need less time for preparation. This makes you less vulnerable to being caught off guard yourself.

The third possibility is that you are playing against someone who is very aggressive, perhaps reckless. If this is the case, try to get your opponent to over-commit

and perhaps lose sight of the objective, allowing you an opportunity to pounce while the enemy is distracted elsewhere. Maybe you can cause the enemy forces to get strung out. An over-aggressive player is easier to sucker into making this kind of blunder.

The final possibility is an intelligence report by itself. Learn what makes your opponent feel desperate, and try to induce that feeling as often as possible.

Campaign Tactics Exercises

1. You want to add some torpedo capability to a squadron of Pit Vipers. You can choose between Thunderbirds and Blizzards. Which would be a better choice overall, and why?
2. Your opponent has a pair of Drakars that you need to stop. Circumstances require you to engage these ships at long range. Fortunately, they are pretty slow so tracking is not a problem. Your options include three Seraphs with Turbo Lasers (High damage) or three Hell Benders with Meld Lasers (Medium damage). Leaving aside the difference in cost, which is the better choice, and why?
3. Your squadron of Lance Electras is escorting a group of three Drakar gunboats. Suddenly an enemy force of six Blizzards appears at a range of about 25 hexes on an attack vector. Your choice is either to send the Lance Electras out to engage them, or stick close. What should you do?
4. Your fleet is about to engage your opponent’s fleet in what promises to be a glorious bloodbath. You have a small group of high-quality fighters with elite crews, a larger group of low-quality ships and crews, and the bulk of your force which consists of decent ships with average to above-average crews. How should you commit them? Should you: (a) lead with your best, (b) throw your low-quality (and therefore expendable) ships in to disrupt the enemy formations, or (c) attack with your average crews, using the elite forces for breakthrough and the poorer units for diversions or simple tasks?

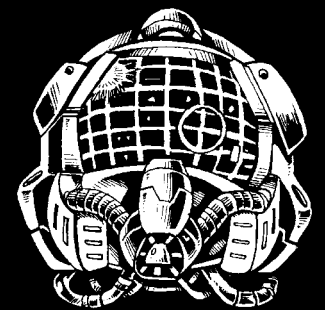

Squadron Profiles

Fortes fortuna adiuvat.
(“Fortune favors the brave.”)
—Terence, Phormio, c. 160 BC

Sadroos Star Riders

1106TH KASHMERE COMMONWEALTH
CONVOY DEFENSE REGIMENT

The Star Riders are a successful example of the specialized convoy defense fighter units so necessary for the continuing success of the Kashmere Commonwealth’s merchant shipping. The Star Riders are organized into three groups each of three squadrons. Each is equipped and organized to operate as an independent convoy escort unit capable not only of repelling attacking pirates, but also of pursuing a beaten enemy to give them something to remember them by. This organization and tactical doctrine was the creation of the Star Riders’ founder, Colonel M. Sadroo (also known to the Kashmeri as “Sadroo the pirate

crusher”). It is a brutally effective system to which many a grateful merchant captain of the commonwealth can attest. The No. 3 fighter group “Kali’s Children” is a typical example of this organization.

Kali’s Children

No. 3 GROUP, 1106TH CONVOY
DEFENSE REGIMENT

As can be seen from the description, each squadron is a specialized part of a three-tiered convoy defense system. The first squadron constitutes the extended layer of the convoy’s defense, relying on the superior performance of the death wind and the added advantage of the rear gunner to dominate fights with opponents of comparable tonnage. The second squadron constitutes the close escort of the convoy, utilizing the excellent firepower and handling characteristics of the Hell Bender and the awesome firepower of the Black Widow to smash anything getting past the first squadron. The third squadron acts as both a mobile reserve, utilizing the Darts enormous speed advantage to race to any point of crisis, and to pursue and harass any survivors fleeing from the battle. This has proven a highly effective system against even the most determined attackers.

Unit Summary

No. 1 FIGHTER SQUADRON “RATHORS”

Squadron Leader:

Soohas Nehru (Plt 9, Gnr 9)

Assets: 12x Death Wind

No. 2 FIGHTER SQUADRON “FIST OF GANESH”

Squadron Leader:

Shulpa Patel (Plt 10, Gnr 9)

Assets: 8x Hell Bender II
4x Black Widow

No. 3 FIGHTER SQUADRON “PUNJABI FALCONS”

Squadron Leader:

Alexander Singh (Plt 9, Gnr 9)

Assets: 12x Dart

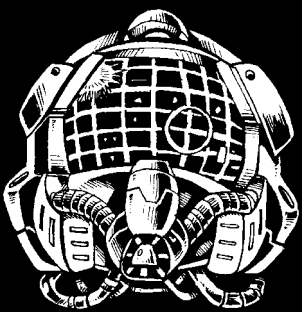
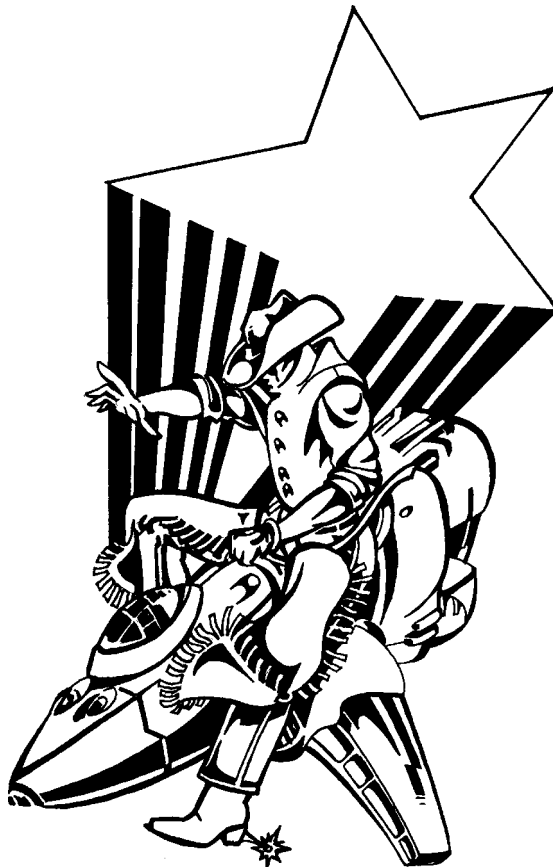

The King's Messengers

YOKA-SHAN WARWORLD 221ST SPECIAL TASKS UNIT

The “King’s Messengers” is a unique unit within the combat formations of the Yoka-Shan Warworld. While the Warworlders have many excellent fighter units that are available for punishing those who fail to pay a debt owed to the Warworld, the King’s Messengers are unique among these “dead-beat” executioner units.

Because of their unique mission profile, the King’s Messengers are a unique group of people. All prospective candidates are subjected to a rigorous psychological and spiritual screening process intended to weed out all but those with an unusually intense and deeply held sense of justice and personal awareness. Since the 221st’s founding, never once has a King’s Messengers failed in their duty without paying with their lives in the attempt. This level of professionalism shows no sign of wavering.

Although the 221st is a mercenary unit open for hire like any other Yoka-Shan combat unit, the King’s Messengers come with a very heavy price tag. The cost is nearly five times the normal going rate for a Warworlder fighter unit, paid in advance!

The 221st is so well known that many a would-be aggressor thinks twice if the intended victim (or the victim’s relatives) have the resources to hire the 221st. This also applies to special situations, as the 221st has a process of appeal for those who cannot afford to pay the huge fees required, but who may nonetheless have an unusually worthy case.

Historical footnote: the ships of the 221st are painted in a very dark charcoal gray. No markings of any sort other than individual ship numbers and names appear on any King’s Messenger fighter. The Nemesis gunboats of the third squadron were donated to the 221st by the shipping magnate Knut Homme out of gratitude for services rendered. All of the Nemesis gunboats bear the ancient Latin motto “ultima ratio regum” (“The final argument of kings”) in

bold lettering along both sides of the hull. This was Knut Homme’s personal message to the murderers of his granddaughter and sole heir. Thereafter it became the unofficial motto of the King’s Messengers.

Unit Summary:

1ST SQUADRON “GRIOTS”

Squadron Leader:

Alexander Kun’ Voerhoven
(Plt 10, Gnr 10)

Assets: 24x Blizzard

2ND SQUADRON “SPEAK THEIR MINDS CLEARLY”

Squadron Leader:

Roger Sauvage (Plt 10, Gnr 10)

Assets: 16x Black Widow

3RD SQUADRON “THE FINAL WORD SPOKEN”

Squadron Leader:

Quase’ Fulani (Plt 10, Gnr 10)

Assets: 12x Nemesis



The Next Millennium

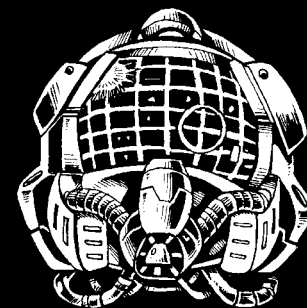

The Lynch Mob

3RD LOMA VERDE COMPOSITE CITIZEN'S FIGHTER DEFENSE REGIMENT

The 3rd Loma Verde CCFD regiment is one of five such umbrella organizations constituting the fighter defense network protecting the colony of Loma Verde and the associated Herrera shipyards. It was organized to serve as a central command structure in time of emergency for the various local reserve citizen's fighter wings based on the colony and the outer planets of the system. The CCFD regiments also provide a venue for the various reserve units to receive ongoing training under the tutelage of the hired professional fighter pilots who act as the regimental command cadre. This has proven to be a fairly effective system due in no small part to the training priority placed on gunnery skills and team tactics by the Warworlder and Karelian advisors employed by the government of Loma Verde.

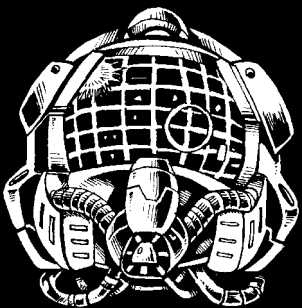

Unit Summary

REGIMENTAL COMMAND FLIGHT, 3RD CCFD REGIMENT

Acting Regimental Commander:

Juba Usuthu (Plt 9, Gnr 9)
(Yoka-Shan)

Assets: 4x Deathwind

1ST ATTACHED SQUADRON, 3RD CCFD REGT.

(21ST LOCAL DEFENSE SQN. SHIPYARD WELDERS)

"THE FIRE GUARDS"

Squadron Motto: "Too Hot To Touch!"

Squadron Leader:

Candalario "El Pistolero" Guerrero
(Plt 5, Gnr 8)

Assets: 24x Chupacabra

2ND ATTACHED SQUADRON, 3RD CCFD REGT.

(1ST LOCAL DEFENSE SQN. HOVERCAB DRIVER'S)

"THE TAXI DRIVERS"

Squadron Motto: "You Lookin' At Me?"

Squadron Leader:

Ramon "El Loco" Cortez
(Plt 6, Gnr 6)

Assets: 24x Chupacabra

3RD ATTACHED SQUADRON, 3RD CCFD REGT.

(2ND RANCH HANDS LOCAL DEFENSE SQN.)

"THE RUSTLIN' REPTILES"

Squadron Motto: "What Goat?"

Squadron Leader:

Benjamin "Breaker" Casteneda (Plt 6,
Gnr 9)

Assets: 24x Chupacabra

**4TH ATTACHED SQUADRON,
3RD CCFD REGT.**

**(3RD PROGRAMMERS
LOCAL DEFENSE SQN.)**

**“FINNEGAN’S FLYING FEEDING FRENZY”
(AKA “THE 4 F’S”)**

Squadron Motto:

“You Will Stick In Our Teeth!”

Squadron Leader:

Concepcion “La Azteca” Finnegan
(Plt 7, Gnr 7)

Assets: 16x Pit Vipers
16x Stingers

This system was already in place when the Grubs first came to Loma Verde, augmented by the eleventh hour production of an effective, locally produced light fighter developed by the Herrera Shipyards. Short-falls in deliveries of Pit Viper and Stinger class fighters on order before the Grub War

were filled by the HSF-1 “Chupacabra,” named for a local pest/predator much despised by Loma Verde’s numerous sheep and goat herders. The ship proved to be a winning design. Better still, the “Chupy” utilized minimal strategic materials and has a brief maintenance cycle allowing for very short down time between missions: no more than 10 minutes between combat flights with a skilled hangar crew.

Equipped with an effective ship and led by competent mercenary commanders, the citizen pilots of Loma Verde succeeded in giving such a good account of themselves that the Grub swarm attempting to infest the system was driven off with staggering losses. This order of battle has stayed in place ever since, as many pirate groups found out the hard way after the Grub War. Herrera Shipyards has also begun to export the “Chupy” to other small colonies in need of cheap but effective fighter craft.

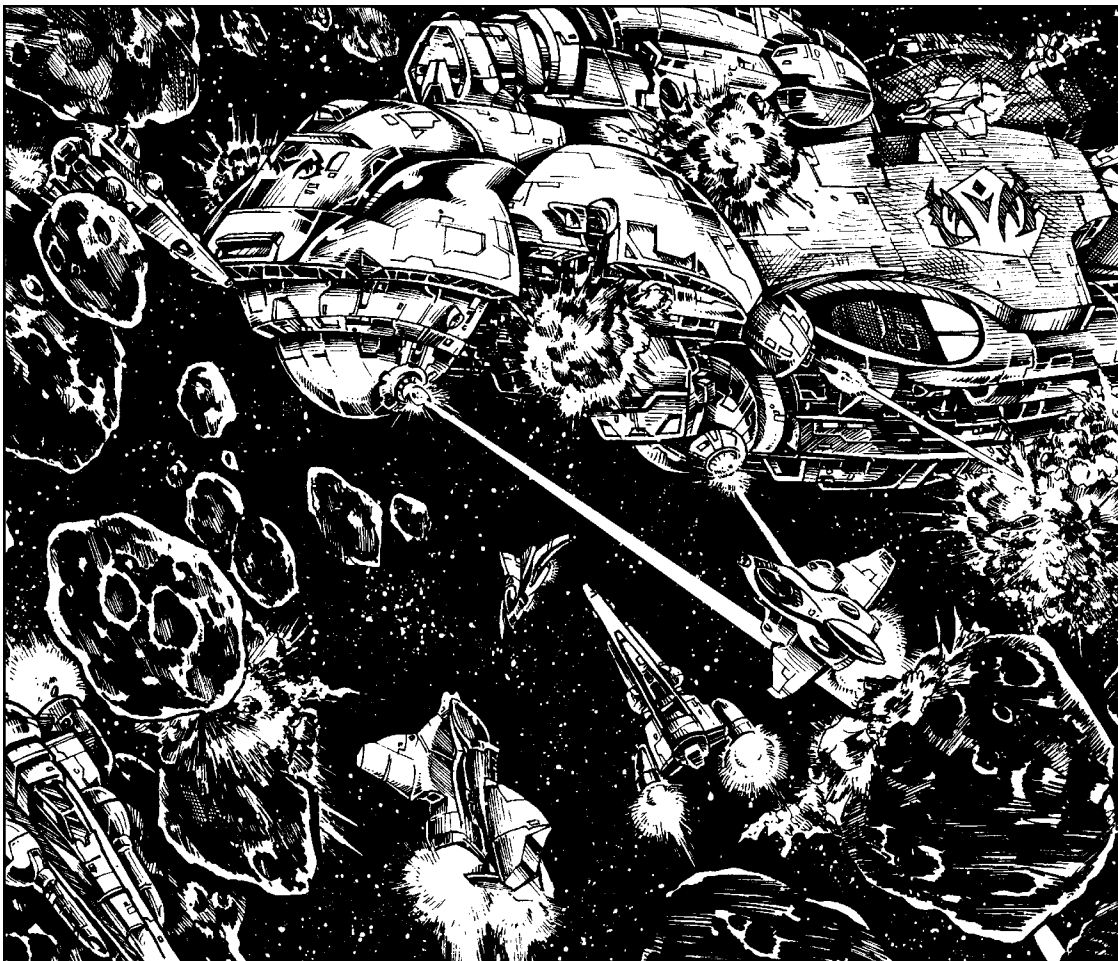

The Next Millennium

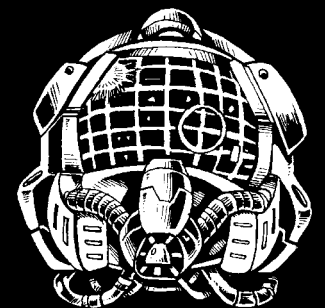

Scenarios

“The measure may be thought bold, but I am of opinion the boldest are the safest.”

—Lord Nelson to Sir Hyde Parker, urging immediate action against the Danes and Russians, 24 March 1801

Now that you are brimming with tactical expertise, we have written the following scenarios to help you practice and hone your skills. The following scenarios concern different combat problems that cry out for smart, innovative resolution. Most of these scenarios have special rules, and some of them also use optional rules from the Silent Death: The Next Millennium rulebook.

Scenario 1: The Piranha Gambit

“Quantity has a quality all its own.”

—V. I. Lenin

While navigating a nearby asteroid field, a Draconian Betafortress Beta has become separated from its battle group. The Draconian Raiders subjected the local outpost to merciless attacks using the Betafort to terrible effect. Now, while the gunboat is separated from its supporting ships and exposed in open space, the local militia has a long-awaited chance to even the score.

So much for the good news. The bad news is that the window of opportunity is small. The locals do not have time to call in their heavier ships from long-range patrols. It is therefore up to the smaller attrition squadrons to take down this massive

foe. Fortunately, elements of the 4th Attached Squadron, 3rd CCFD Regt. (“Finnegan’s Flying Feeding Frenzy”) include some slightly heavier assets. Even so, it will take careful strategy and hard fighting to take out the big Betafort.

1922nd Frontier Squadron

Set up second along edge 2.

Pit Viper A	Pilot (Plt 6, Gnr 6)
Pit Viper B	Pilot (Plt 6, Gnr 5)
Pit Viper C	Pilot (Plt 7, Gnr 8)
Pit Viper D	Pilot (Plt 8, Gnr 9)
Pit Viper E	Pilot (Plt 5, Gnr 7)
Pit Viper F	Pilot (Plt 7, Gnr 6)
Stinger A	Pilot (Plt 7, Gnr 5)
Stinger B	Pilot (Plt 8, Gnr 7)
Stinger C	Pilot (Plt 7, Gnr 6)
Stinger D	Pilot (Plt 9, Gnr 7)

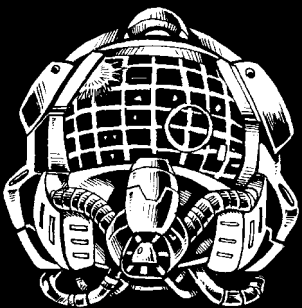
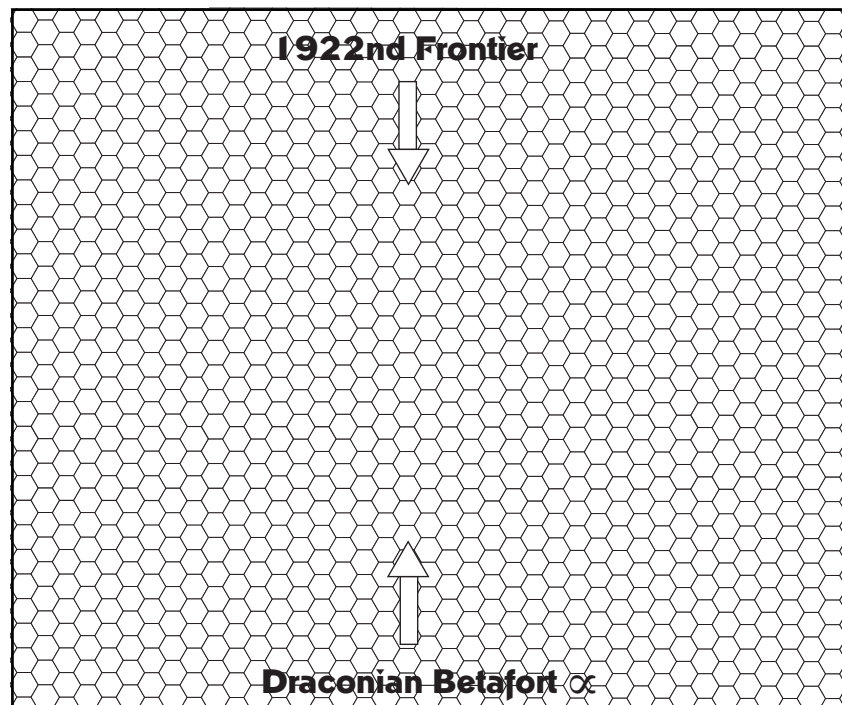

Draconian Raiders

Set up first along edge 4.

- Betafortress Beta A Pilot (Plt 7, Gnr 6)
- Gunner A (Gnr 7)
- Gunner B (Gnr 6)
- Gunner C (Gnr 5)
- Gunner D (Gnr 6)
- Gunner E (Gnr 7)

Victory Conditions

The Frontier squadron must destroy the Betafortress within eight turns without suffering losses greater than 60% of their total point value. Total up the losses of the CCFD player at the end of each turn.

Scenario 2: Catch As Catch Can!

"Hit 'em where they ain't."

—"Wee Willie" Keeler, 1872-1923

During the course of the Karelian war a Draconian sympathizer succeeded in disabling the stardrives of a freighter carrying badly needed supplies to the besieged Karelian system. While the disabled freighter drifted helplessly just inside the Karelian border a mercenary gunboat unit employed by the Draconians sped across the border in an effort to destroy the freighter and deny the Karelians their badly needed supplies. While most gunboat units operate with fighter support, the mercenary unit had lost its fighter support during an encounter with the Karelian 3rd fighter regiment "Werewolves" just hours before. The four gunboats escaped unscathed by abandoning their comrades to annihilation at the hands of the Karelians when the gunboat leader realized that the fighters they were engaging were not ordinary Teal Hawks, but an entirely new and lethal variant.

Seeking to redeem themselves in the eyes of their Draconian employers, the gunboat flight agreed to undertake this mission on the spot. It would prove a risky mission indeed, as the Karelian fighter patrols marauded along the disputed border.

Forces

Gunboat flight of the 353rd Fighter Squadron "Logan's Looters"

Set up first along edge 1 within two hexes of the board edge.

- | | |
|----------|-----------------------|
| Epping A | Pilot (Plt 10, Gnr 7) |
| | Gunner A (Gnr 8) |
| | Gunner B (Gnr 7) |
| | Gunner C (Gnr 8) |
| Epping 2 | Pilot (Plt 7, Gnr 7) |
| | Gunner A (Gnr 9) |
| | Gunner B (Gnr 6) |
| | Gunner C (Gnr 6) |
| Epping 3 | Pilot (Plt 8, Gnr 6) |
| | Gunner A (Gnr 10) |
| | Gunner B (Gnr 7) |
| | Gunner C (Gnr 8) |
| Epping 4 | Pilot (Plt 7, Gnr 9) |
| | Gunner A (Gnr 7) |
| | Gunner B (Gnr 8) |
| | Gunner C (Gnr 6) |

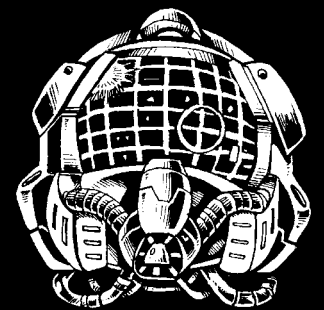
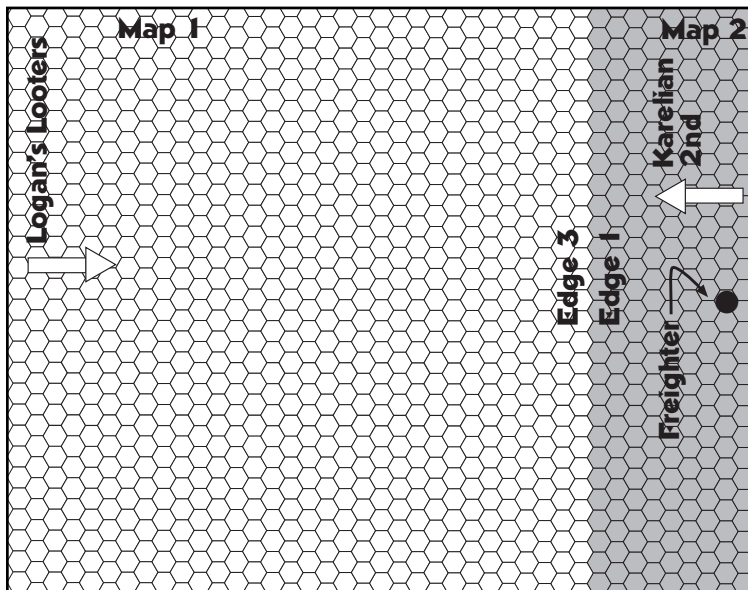

Silent Death

Assorted Karelian fighter sweep elements (3rd, 6th, and 7th Fighter Squadrons, Karelian 2nd Fighter Regiment)

Set up second anywhere along edge 3.

Turn 1 patrol flight:

Thunder Bird A: Pilot (Plt 7, Gnr 7)

Thunder Bird B: Pilot (Plt 8, Gnr 8)

Thunder Bird C: Pilot (Plt 6, Gnr 6)

Thunder Bird D: Pilot (Plt 6, Gnr 6)

After the discovery of the Epping flight racing toward the disabled freighter, the Karelian fighter patrol leader realized the intentions of the intruders. He immediately sent out a wide band alert broadcast requesting assistance from any other fighters in the area. The Karelians proceeded to attack in an effort to delay the Eppings until help could arrive.

Special Rules

At the beginning of each turn the Karelian player consults the appropriate random fighter patrol chart and rolls one die of the type appropriate to the table in use. The result of the die roll will indicate which reinforcements will enter from the Karelian side of the board during the current turn's movement phase. Pilot and gunnery skills for the randomly generated reinforcements are determined by rolling 1D4+5 for both pilot and gunnery skills. This range of possible skills reflects the Karelians' obsessive emphasis on training before considering a fighter pilot worthy of combat.

Turn 1 reinforcements (1D4)

1 = 2 x Kosmos

2 = 2 x Teal Hawk

3 = 2 x Pit Viper

4 = 2 x Dart

Turn 2 reinforcements (1D6)

1 = 2 x Kosmos

2 = 2 x Teal Hawk

3 = 2 x Pit Viper

4 = 2 x Dart

5 = 2 x Thunderbird

6 = 2 x Nighthawks

Turn 3+ reinforcements (1D8)

1 = 2 x Kosmos

2 = 2 x Teal Hawk

3 = 2 x Pit Viper

4 = 2 x Dart

5 = 2 x Thunderbird

6 = 2 x Nighthawks

7 = 2 x Salamander

8 = 2 x Lance Electra

The scenario uses two playing boards placed adjacent along their long sides. The disabled freighter is placed in the center of the playing area between boards G and H on the side opposite the edge through which the Eppings will enter. The freighter is completely helpless and can offer no resistance whatsoever. The freighter possesses 80 damage boxes. The Eppings must destroy the freighter and exit at least one of their number back off of the playing board to win (edge 1) to win.

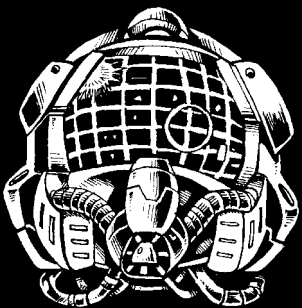

Scenario 3: Space Billiards!

“In war the power to use two fists is an inestimable asset. To feint with one fist and strike with the other yields an advantage, but a still greater advantage lies in being able to interchange them—to convert the feint into the real blow if the opponent uncovers himself.”

—B. H. Liddell Hart,
Thoughts on War, I, 1944

While conducting a routine fighter sweep on the outer rim of the Loma Verde System, the No. 2 wing of the “Rustling Reptiles” detected a superior force of unidentified fighters on an intercept vector. Realizing that the intruders were hostile, and that their light “Chupacabra” fighters were outgunned by the hostiles, Flight Leader Ramon “Razorback” Bautista led his flight into a heavy meteor storm in an effort to even the odds.

Forces

No. 2 Flight, “Rustlin’ Reptiles”

Set up first in Areas C or D.

Chupacabra A	Pilot (Plt 9, Gnr 8)
Chupacabra B	Pilot (Plt 8, Gnr 7)
Chupacabra C	Pilot (Plt 7, Gnr 7)
Chupacabra D	Pilot (Plt 6, Gnr 7)
Chupacabra E	Pilot (Plt 6, Gnr 6)
Chupacabra F	Pilot (Plt 6, Gnr 6)

2nd Flight, “Death’s Head” Squadron, Draconian Fighter Forces

Set up second on edge 3.

Salamander A	Pilot (Plt 7, Gnr 7) Gunner (Gnr 7)
Salamander B	Pilot (Plt 7, Gnr 6) Gunner (Gnr 7)
Salamander C	Pilot (Plt 7, Gnr 8) Gunner (Gnr 6)
Salamander D	Pilot (Plt 6, Gnr 6) Gunner (Gnr 6)
Salamander E	Pilot (Plt 5, Gnr 5) Gunner (Gnr 6)
Salamander F	Pilot (Plt 5, Gnr 6) Gunner (Gnr 6)

Special Rules

1) Boards A and B are the outer edge of a meteor storm. Any ship that moves into these hexes is subject to possible hits from meteors of varying impact. To determine if a meteor strikes a particular ship roll 1D10 for each ship before every warhead launch phase. If the result is even then play proceeds as normal. If the roll is odd then the ship has strayed into the path of oncoming meteors. Players may attempt dodge rolls against meteors. Dodging these are handled the same as a dodge against a single torpedo. To determine the attack value of the meteor affecting the ship roll 1D6 and consult the following table:

- 1 - 3D6, Low damage
- 2 - 3D6, Medium damage
- 3 - 3D6, High damage
- 4 - 3D6, All damage
- 5 - 3D6, All x 2
- 6 - 3D6, All x 3

The winner of the scenario is the side with any surviving pilots left on the board.

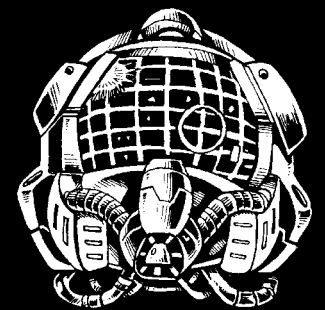
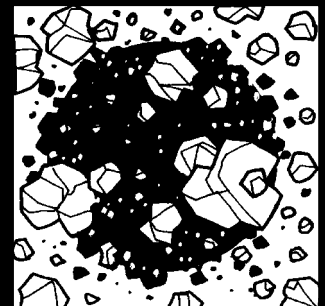
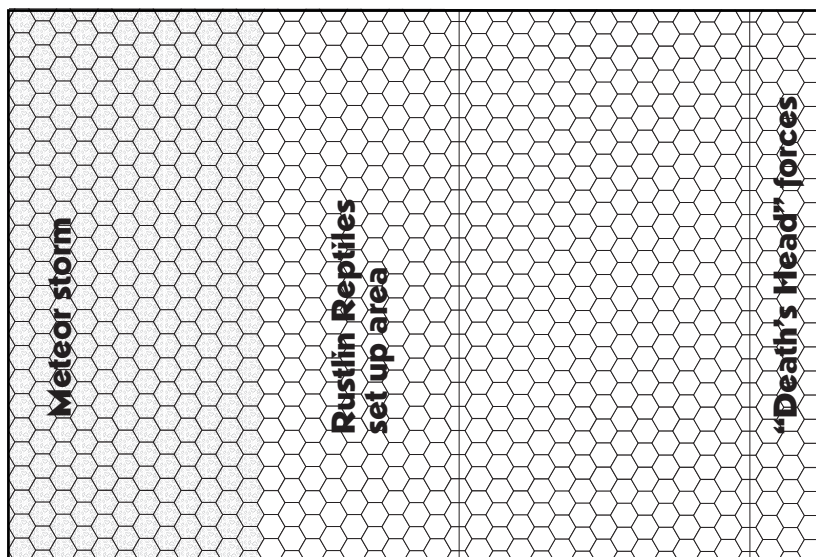

Answers to Exercises

Basic Tactical Concepts

"If men make war in slavish obedience to rules, they will fail."

—U. S. Grant, Personal Memoirs, 1885

1. Yes. Remember, if the ship on the outside of the turn has enough points to make the maneuver, all of the ships in the formation can make it.

2. False. Dividing your forces means that instead of one strong force, you have two weaker forces. If they can come to the aid of each other, that is one thing. If one part gets isolated, you may lose it.

3. True. Although roughly half of the opposing ships are under attack at a time, they are under much heavier attack. By ganging up on a few ships, you create zones of local superiority.

4. In this case, the Glaives are probably the most dangerous part of the opposing force. Try to concentrate as much fire on the Glaives as quickly as you can, before they eat your lunch.

5. No. It cannot dodge torpedoes, so fire a few well-aimed torpedoes at it, and confront the new threat. Or, if the newcomers are too much trouble, run for it. Either way, the heavy fighter is toast.

6. False. Look again at the diagram in this chapter. There are gaps in the fire zones when only three ships are in the circle.

Weaponry

"The Nemesis-class gunboat is best described as a Lufbery Circle consisting of a single ship."

—Reviewer, Imperial Defense Quarterly

1. Yes. The torpedo cannot hit the black fighter this turn.

2. A pilot with a piloting skill of 9 only needs to roll a 3 or better to successfully dodge one torpedo. That is an 80% chance each time. If those odds sound good, close deliberately with one torpedo in such a way that the other torpedo cannot reach you

this turn, and go for a dodge. Do the same with the second torp on the next turn. Do not forget to attempt a jam on each turn in addition. Chances are, you will make it.

3. The percent chance to hit is 40%.

4. The chance that at least one of the ships will hit is 87.6%.

5. For skill 7 pilots, damage is $2 \times 2.58 + (2 \times .389)$ or 8.75 points of damage. Skill 9 pilot expects to do $3.09 + (2 \times .5)$ or 4.09 points of damage. Together they do 10.04 points of damage.

7. Since the Plazgun does "All" damage, the roll To Hit is approximately the amount of damage, leaving out pluses or minuses for range, etc. If you hit the target, your damage is going to be at least 16 at medium range.

Situational Tactics

"When the situation is obscure, attack."

—Attributed to General Heinz Guderian

1. Both the Lance Electra and the Death Wind have weapons with long enough range that they can strike a Revenge without fear of being hit by anything but a torpedo. However, the Lance Electra's protobolts have a finite ammo supply, while the Death Wind's Ion Ram does not. Furthermore, the Ion Ram can do much more damage at long range. If your fighters are adept at evading torpedoes, they can hang out of missile range and pound away at the heavy fighters. Therefore Death Winds are the correct choice.

2. Add one of the Night Hawks with a very high gunnery skill level. The light guns of the Spirit Riders will not make much of an impression if the target has a respectable damage reduction. With a high gunnery skill level in the Night Hawk can reduce the damage reduction of a target or targets enough for the Spirit Riders to be more of a threat. And when a feint is more dangerous, it is more likely to be taken seriously, which is the whole idea of a feint.

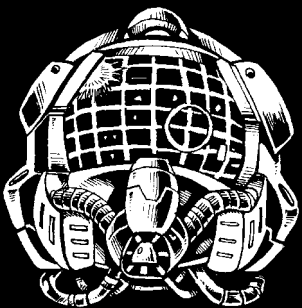

3. Use the undamaged Night Hawk. It stands a good chance of slowing down or stopping the Teal Hawk. A damaged ship has lost some of its damage reduction, speed, and perhaps one or more weapons. To throw one of the damaged Night Hawks in front of the Teal Hawk would almost certainly mean losing it.

4. For these kinds of short actions, the Epping is probably the best choice. If it survived the first round of cannon fire, it can launch its heavy missile load before the next movement phase. This lets it retire quickly before additional cannon fire can be brought to bear. In addition, its four Mk. 30 torpedoes can finish off crippled opponents after the Epping has made its escape, or strongly discourage pursuers.

5. Try to accomplish two things. First, get your fighters regrouped so they can concentrate their fire. Second, try to direct their combined firepower against one or two likely targets once your opponent has moved one or two ships.

Campaign Tactics

“After winning a great victory, a haughty heart, disdain for the enemy, and incautious actions often follow. Avoid this. There have been many families in the past destroyed in this manner.”

—Hojo Ujitsuna, 16th century Samurai Warlord

1. Use the Blizzards. They can keep up more easily with the Pit Vipers, their torp load is very nearly as good, and they are cheaper than Thunderbirds.

2. Use the Seraphs. Since their Turbo Lasers do High damage, over the long term they will probably do more damage to the target than the Meld Lasers.

3. Stay close to your convoy. The Lance Electra packs a substantial punch, but it is significantly slower than a Blizzard. If you dash out to meet them, the Blizzards can blow right by your fighters and drop their torps practically on top of the hapless Drakars. Meanwhile, the Electras will get turned around just in time to see the Blizzards come blowing past on their way home. Instead, stay close to the gunboats, and let the attackers come to you. Use your torps to intercept their torps. Your missiles and protobolts will ensure that not all of the Blizzards get out in one piece.

4. For most situations, the answer is (c). Do not lead with your elites if you want to keep them. Use them for unconventional uses or the final breakthrough. “Unconventional” should not be construed to mean “stupid.” The average units can use their numbers to wear down the enemy, and if they are used intelligently, they can sometimes achieve a breakthrough themselves. Give the low-end forces some respect; do not just throw them away. Use them for things that are within their capabilities.

WORKSHEET

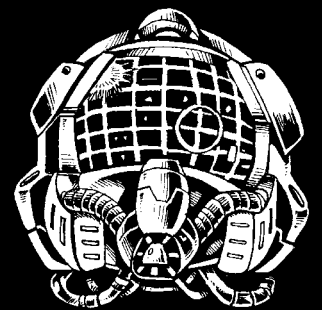



For Further Reading

“To fly a combat mission is not a trip under the moon. Every attack, every bombing is a dance with death.”

—Serafima Amsova-Taranenko,
Soviet Bomber Pilot, World War II

Learning about real-world air combat can help you improve your gameboard tactics. The following is a suggested list of books that will help you better understand strategy and tactics in general, and fighter tactics in particular. Most of these books are available either from your local book dealer, or your local school or public library.

Bishop, William A. *Winged Warfare*. (Garden City, NY: Doubleday), 1967.

Boyington, Gregory. *Baa Baa Black Sheep*. (Fresno, CA: Wilson Press), 1958.

Boyington proved himself a remarkably innovative and insightful tactician, one who was not hesitant to challenge conventional tactical thinking.

Frank, Norman. *Aircraft Versus Aircraft. The Illustrated Story of Fighter Pilot Combat Since 1914*. (New York: Macmillian Publishing Company), 1986. Well-written discussion on the historical development of individual and group fighter tactics and aircraft, clearly explained with useful diagrams.

Gallagher, James J., CSM U.S.A. (Ret.), ed. *Combat Leader's Field Guide*, 11th edition (Mechanicsburg, PA: Stackpole Books), 1994. This book contains an excellent summary of basic rules for successfully conducting armed conflict. Also some good material on basic principles of small unit tactics that can be fruitfully applied to the gameboard.

Galland, Adolph. *The First and the Last*. (New York: Bantam Books), 1978. Memoirs of one of Germany's greatest aces of World War II.

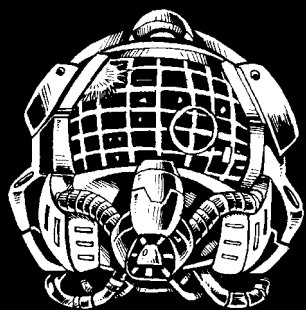

- Gunston, Bill and Lindsay Peacock. *Fighter Missions: Modern Air Combat - The View from the Cockpit*. (New York: Crown Publishers, Inc.). Also available through the Military Book Club.
- Handel, Michael I. *Masters of War: Classical Strategic Thought*. Second, revised edition (London: Frank Cass), 1996. An interesting study of general strategy in which the author, an instructor at the US War College, shows how the basic principles of both western and eastern strategists are ultimately the same. Certain to provoke controversy, but very instructive. Available through Barnes & Noble.
- Johnson, Robert S., with Martin Caidin. *Thunderbolt!* (New York: Ballentine Books), 1959. Memoirs of the top US Marine Corps fighter ace of World War II.
- Juutilainen, Ilmari. *Double Fighter Knight*. Heikki Nijunen and Paul Gillcrist, trans. (Tampere, Finland: Uusi Kivipaino Oy), 1996. Fascinating memoir by Finland's top scoring ace (94 kills) of World War II. Juutilainen's descriptions of Finnish pilot training helps explain how the Finns, outnumbered and using obsolete equipment, achieved kill ratios as high as 32:1 against their Soviet opponents.
- Longstreet Stephen. *The Canvas Falcons*. (New York: Ballentine Books), 1972. Well-written, lucid and detailed account of the people, planes, and machines involved in World War I air combat. Good study of the early evolution of air combat doctrines. Available as a reprint from Barnes & Noble.
- Luukkanen, Eino. *Fighters Over Finland*. (London: Macdonald), 1963.
- Musashi, Miyamoto. *A Book of Five Rings*. Victor Harris, trans. (Woodstock, NY: The Overlook Press), 1974. A classic on strategy by a warrior who came to define what it meant to be Samurai. This book has been a major influence on Asian tactical thinking for centuries.
- Noggle, Anne. *A Dance With Death*. Soviet Airwomen in World War II. (College Station, TX: Texas A&M University Press), 1994. Intriguing and moving stories of Soviet women combat pilots and ground crew, told in their own words.
- Nordeen, Lon. *Fighters Over Israel*, illustrated by Ken Kotik. (Orion Books), 1990. A fascinating discussion of Israeli fighter tactics used in several recent conflicts.
- Park, Edward. *Fighters. The World's Great Aces and Their Planes* (Charlottesville, VA: Thomasson-Grant), 1990.
- von Richthofen, Manfred F. *The Red Air Fighter*. (New York: Arno Press), 1972. Air combat and tactics described in detail by the Red Baron himself.
- Rickenbacker, Eddie V. *Fighting the Flying Circus*. (Garden City, NY: Doubleday), 1965. Memoirs of the top-scoring American ace of World War I.
- Sakai, Saburo, with Martin Caidin and Fred Saito. *Samurai!* (Garden City, NY: Nelson Doubleday), 1978. Memoirs of one of Japan's greatest World War II aces.
- Shaw, Robert L. *Fighter Combat - Tactics and Maneuvering* (Annapolis, MD: Naval Institute Press), 1985. This is one that real fighter jocks study! If you must buy only one of the books on this list, make it this one.
- Sims, Edward H. *Fighter Tactics and Strategy, 1914-1970*. (Fallbrook, CA: Aero Publishers), 1980.
- Spick, Mike. *Fighter Pilot Tactics*. (New York: Stein and Day), 1983.
- Sun-Tzu. *The Art of War*. Several translations and editions are available. Written over 2500 years ago, it remains one of the classic texts on military strategy. Master Sun had a tremendous influence on the contents of this manual.
- Yeager, Charles. *Yeager*. An Autobiography. (New York: Bantam Books), 1985. Recollections by one of the premier air-warriors of the United States. The chapter on his experiences as a fighter pilot in World War II is a must-read.

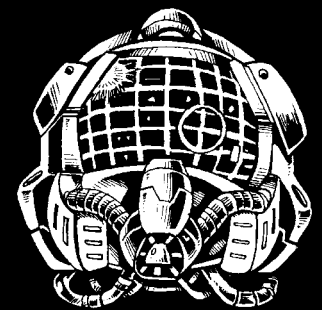

Worksheets

“Success in war is obtained by anticipating the plans of the enemy, and by diverting his attention from our own designs.”

—Francesco Guicciardini,
1483-1540

You may photocopy the following two pages and use them in planning and analyzing tactical problems. Use these sheets to take notes and experiment. You can put these sheets inside a plastic page sleeve and use a dry-erase marker or grease pencil to

draw up your nefarious plans! Keep a few extra sheets around to permanently record your moments of unearthly brilliance (or abysmal stupidity).

Long map setup below

Battle Plan inside front cover

A ruled section for notes, plus a compact hex grid for diagrams and sketches.

All-map sheet inside back cover

It shows the difference in size between the standard play surface and the geo-hex battle map.

LONG MAP SETUP

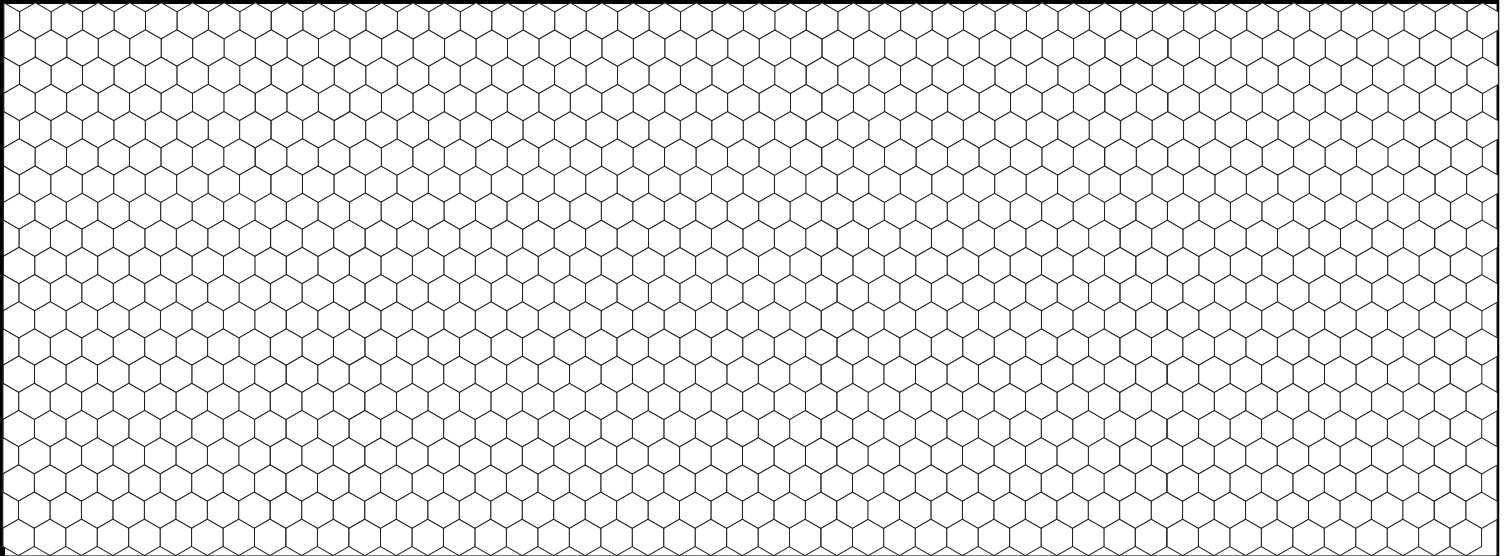

PERCENTAGE TO HIT CHART

Def. Value	3	4	5	6	7	8	9	10	11	12	13	14	15	16	17	18
2D6+1D4	100	99	97	93	86	76	64	50	36	24	14	7	3	1	0	0
2D6+1D6	100	99	98	95	91	84	74	62	50	38	26	16	9	5	2	1
2D6+1D8	100	99	99	97	93	88	81	72	61	50	39	28	19	12	7	3
2D6+1D10	100	99	99	97	94	90	84	77	69	60	50	40	31	23	16	10
2D8+1D4	100	99	98	96	92	87	80	71	61	50	39	29	20	13	8	4
2D8+1D6	100	99	99	97	95	91	85	78	70	60	50	40	30	22	15	9
2D8+1D8	100	99	99	98	96	93	89	84	77	68	59	50	41	32	23	16
2D8+1D10	100	99	99	98	97	95	91	87	81	75	67	59	50	41	33	25

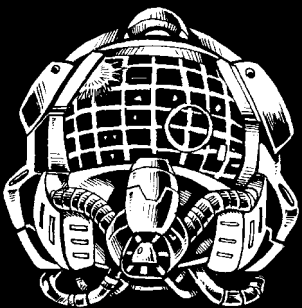

Fighter Designs

The following fighters have been designed using the standard *Silent Death* ship design system. Their designs are based primarily on the tactical and strategic concepts in this manual. We include them here as an example of how these concepts can inform combat starcraft design.

These new ships are used by the following worlds:

Nemesis: Yoka-Shan, Red Star, Hibernia, Sigurd, Q'raj

Black Widow: Yoka-Shan, Tokugawa, Red Star, Karelian Republic, Kashmere, Q'raj

Chupacabra: Karelian Republic, Unkulunkulu, Loma Verde, Red Star, Q'raj

Stinger: everybody!

Bat: Kashmere, Hibernia, Red Star, Tokugawa, Karelian Republic, Data Sphere, Q'raj
Shark: Luches Utopia, Colos, Draconian, ASP***

Bat

Crew: 1

Maneuvering Thrust: 0.119 km/s/s

Mass: 300 tons

Translight Capability: None

Armor: Reinforced Crysteel

Atmospheric Capability: None

Armaments:

4x Mk. 10 Splattergun Blast Cannons

4x Mk. 10 Torpedoes

Commentary: The Bat is designed to be an extremely agile defensive attrition fighter, optimized for dogfighting other attrition fighters of equal or smaller weight. The Bat also makes a reasonably good convoy escort ship if used in quantity. What the Bat lacks in speed and armor it compensates for with exceptionally high agility for a fighter of its size and the defensive advantage of a reasonably armed rear gunner.

Algol Systems A-117 "Stinger"

Crew: 1

Maneuvering Thrust: 0.184 km/s/s

Mass: 100 tons

Translight Capability: None

Armor: Steel Hull

Atmospheric Capability: None

Armaments:

1x Mk. 10 Splattergun Blast Cannon

2x Mk. 40 Torpedoes

Commentary: The effectiveness of many attrition fighters is limited by their initial price tag and upkeep costs. The Stinger is designed to be the ultimate in en masse attrition fighters. Designed to operate in large groups and attack larger opponents, yet relatively cheap and easy to maintain. The Stinger's downside is a logistical one; keeping the little devils supplied with Mk. 40 torpedoes!

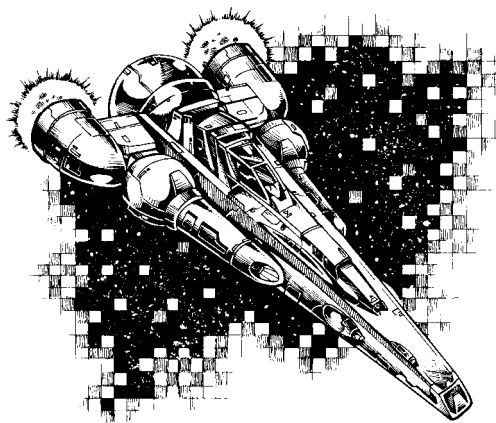
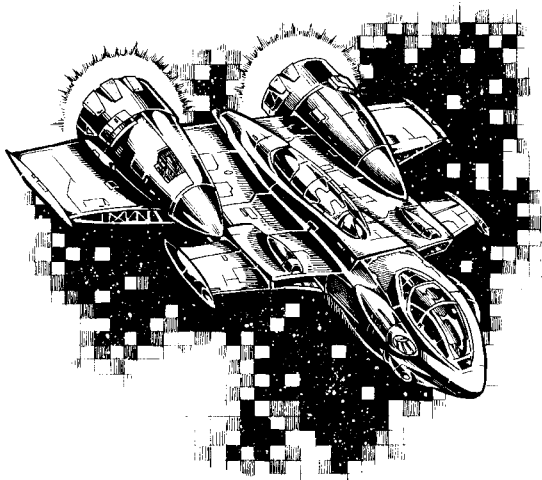

The Next Millennium

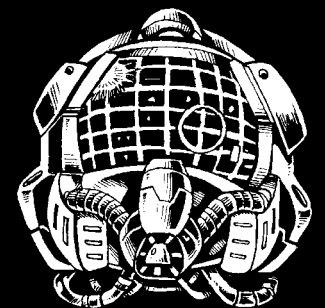

Herrera Consortium A-97 "Chupacabra"

Crew: 1
Maneuvering Thrust: 0.169 km/s/s
Mass: 100 tons
Translight Capability: None
Armor: Steel Hull
Atmospheric Capability: Full
Armaments:

1x Mk. 10 Disruptorgun
2x Missile Launchers
(Magazine: 20 missiles each)

Commentary: Herrera Consortium is one of many civilian shipbuilders forced to take up military ship building by the collapse of the Empire. In the case of Herrera Consortium this conversion came about in direct response to the looming threat of the Grub invasion. In order to protect the local system, Consortium's brilliant design team produced a cheap, low maintenance, and lethal attrition fighter in a very short period of time. Although circumstances required a design that did not use the usual strategic raw materials, the "Chupy" proved a strong performer against Grub craft.

Dionysia Dynamics P-401 "Shark"

Crew: 1
Maneuvering Thrust: 0.177 km/s/s
Mass: 300 tons
Translight Capability: None
Armor: Steel Hull
Atmospheric Capability: Full
Armaments:

1x Mk. 15 Ion Ram
1x Mk. 10 Impulsegun Ion Cannon

Commentary: This medium superiority fighter was the brainchild of a consortium of smaller colonial governments. The goal was to build a fast, relatively agile fighter using public domain internal systems in a new airframe. Now sold abroad and manufactured in several systems under license, the Shark is designed to be a fast gun platform with a respectable "bite." While relatively unarmored, it makes up for this deficiency by being very maneuverable and tough to hit. Do not expect the Shark to stand up to more sophisticated opponents such as the Deathwind or Salamander, but do not underestimate the Shark either!

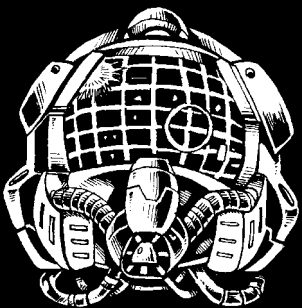
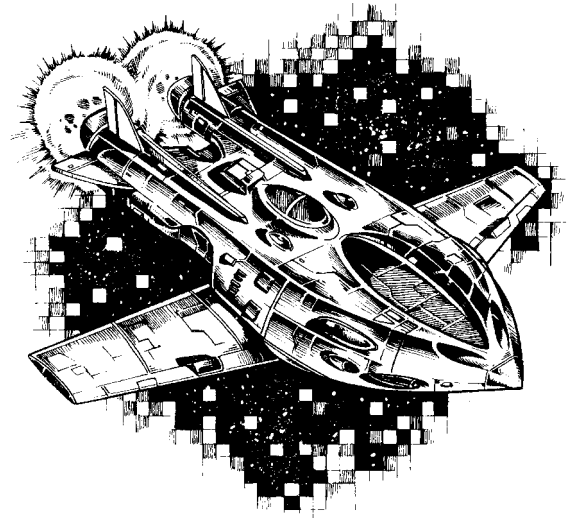
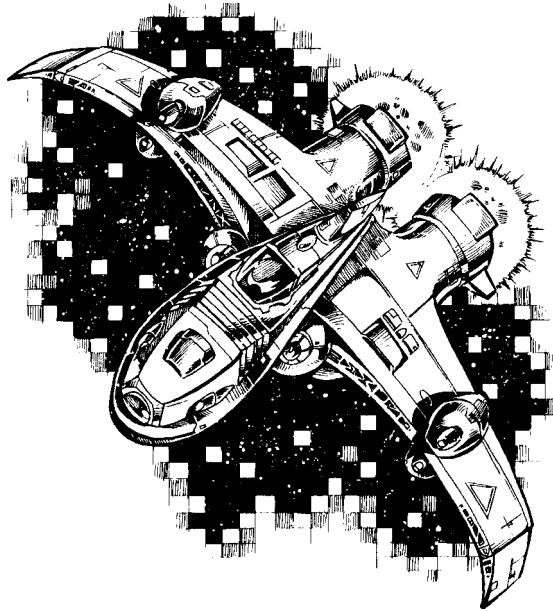

Grivas Armaments EX-198 "Black Widow"

Crew: 3

Maneuvering Thrust: 0.127 km/s/s

Mass: 1000 tons

Translight Capability: None

Armor: Steel Hull

Atmospheric Capability: Full

Armaments:

18x Mk. 10 Splattergun Blast Cannons

10x Mk. 10 Torpedoes

Commentary: The Black Widow is built around the principle of a single ship or pair of ships being able to establish immediate firepower dominance over any given opponent in a cannon duel and totally obliterate that opponent on the first exchange. With three (3) six-gun batteries of Splatterguns, two of those batteries contained in 360-degree counter-rotating turrets (one each ventral and dorsal), and ten Mk. 10 torpedoes for added fun, the Black Widow lives up to its name with a vengeance! Beware the kiss of this Spider Woman!

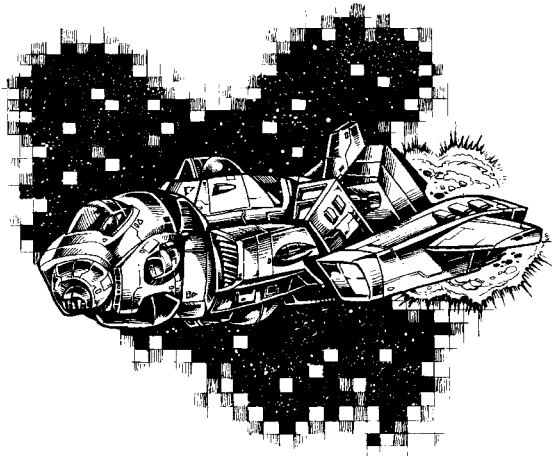

Homme Industries GBX-1 "Nemesis"

Crew: 6

Maneuvering Thrust: 0.124 km/s/s

Mass: 1500 tons

Translight Capability: None

Armor: Steel Hull

Atmospheric Capability: Full

Armaments:

20x Mk. 10 Splattergun Blast Cannons

1x Missile Launchers

(Magazine: 20 missiles)

1x Mk. 15 Ion Ram

10 Mk. 50 Torpedoes

20 Mk. 10 Torpedoes

Commentary: Homme Industries is a civilian shipyard that built a reputation for excellence producing numerous successful cargo ship designs used throughout Imperial Space.

When the head of Homme Industries lost his granddaughter and sole heir in a botched Colosian kidnapping attempt, the old man insisted on revenge that would cause the plotters ... "as much grief as they have caused me!"

Out of this tragedy was born the Nemesis class high speed gunboat. Working with a highly successful priority transport design (the HICC-51 "Mercury"), Knut Homme himself oversaw the design of an unprecedented gunboat configuration. The design dispensed entirely with any armor protection in favor of a superior turn of speed, fighter-like maneuverability, and a truly horrific weapons load meant to overwhelm virtually any opponent on the first exchange of fire.

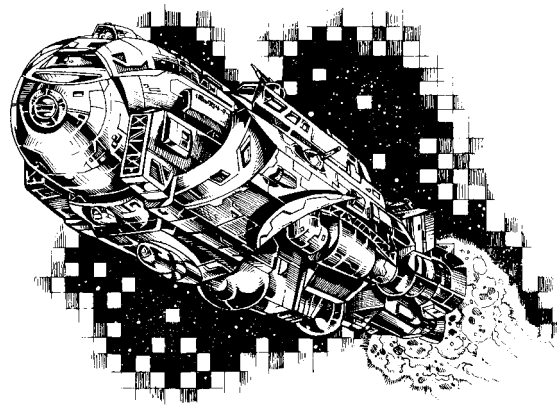

The Next Millennium

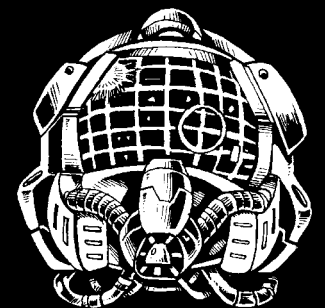

Costs for Maneuverable and Variable Speed Torps

Since the beginning of Silent Death, the Maneuverable Torps (*Silent Death: The Next Millennium Rulebook*, page 72) and Variable Speed Torps (*SDTNM Rulebook*, page 72)) have been two of the most popular optional rules in the game. Maneuverable Torps allow torpedoes to find their targets in a larger area and simplify the already streamlined Silent Death movement system. Variable Speed provides additional flavor to the torpedo rules, giving the game a range of torpedoes, from ultra-fast little Mk. 10s to slow and lumbering but incredibly powerful Mk. 100s. Combined, the two rules make the use of torpedoes fast, entertaining, and exceptionally dangerous.

Unfortunately, Maneuverable and/or Variable Speed Torps are not particularly balanced. The base costs for torpedoes (*Silent Death: The Next Millennium Rulebook*, page 86) assume that normal torpedoes are being put on a ship design. The differences in

cost between the various Mk. numbers represent only the strength of the warhead. These costs were balanced against the costs of other weapon systems. The Maneuverable Torps rule, however, gives torpedoes added capability for free, making them more powerful than other types of weapons with the same point cost. Similarly, the Variable Speed Torps rule make Mk. 10 through Mk. 30 torpedoes more powerful, but hamper the range of Mk. 50 and higher torpedoes, without altering how much a player has to spend. These effects can be vary dramatic.

For example, a Mk. 10 torpedo with either the Maneuverable or the Variable Speed Torps option can reach almost three times the area in one turn that a standard torpedo can. If both options are in effect, the area the torpedo can reach is almost six times as great as that of its unmodified cousin. In another case, a Mk. 60 torpedo has only one-third the area of a standard

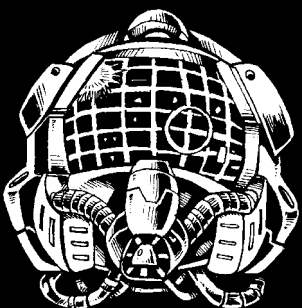
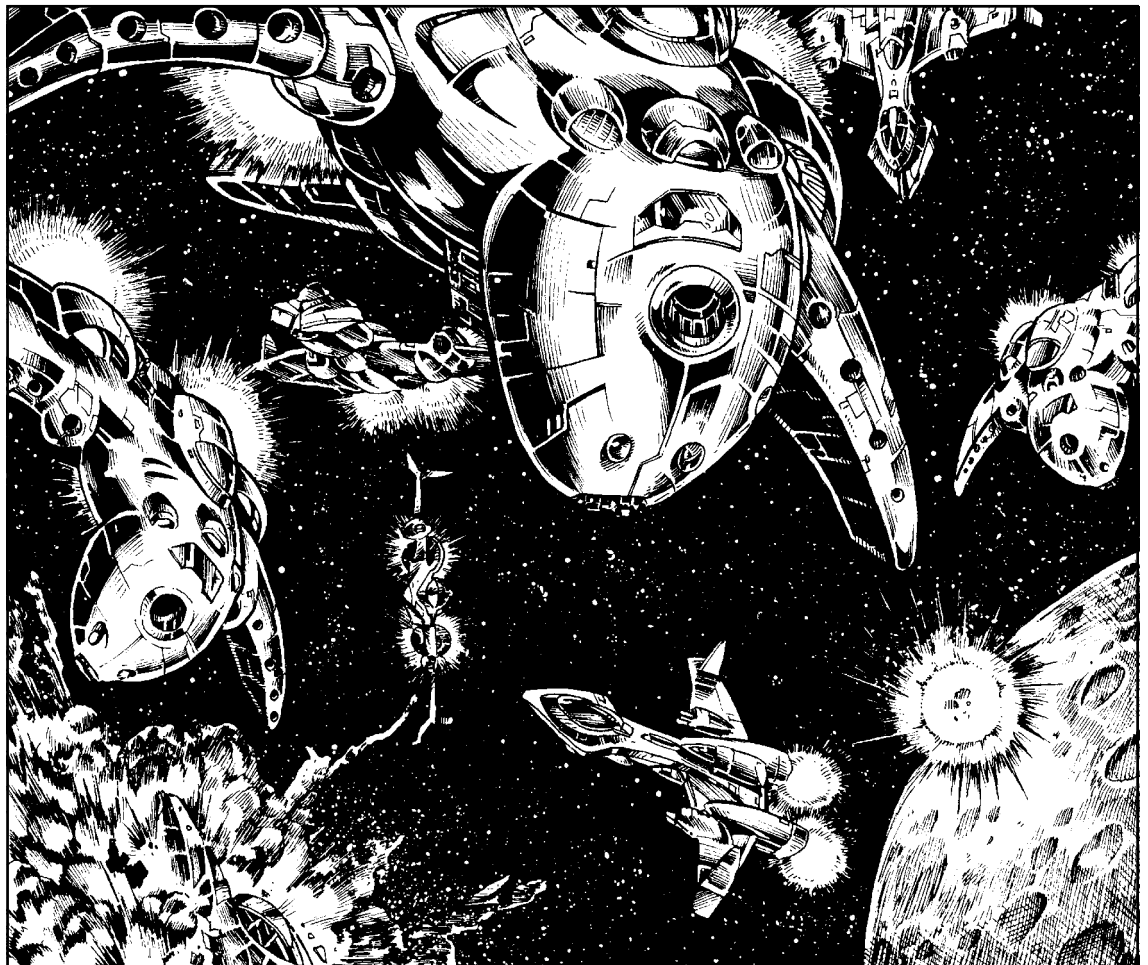

torpedo under the Variable Speed Rules. In both cases the capability of the torpedo has been greatly affected, without any adjustment to its cost.

To solve this problem, the Tactics Manual provides costs to upgrade a ship's torpedoes. These costs take into account the amount of area that can be reached by a torpedo in one turn. They bring ships using these rules into balance with the rest of the system, while allowing more flavour and increased ease of use.

Optional Rules

If any of these optional rules are in effect, the players cannot gain the effects of either the Maneuverable or the Variable Speed Torps optional rules without paying the specified additional cost.

All Ships Must Upgrade to Maneuverable Torps

All players must pay the cost (page 59) to upgrade all torpedoes on their ships to take into account the effect of the Maneuverable Torps optional rule.

All Ships Must Upgrade to Variable Speed Torps

All players must pay the cost (page 59) to upgrade all torpedoes on their ships to take into account the effect of the Variable Speed Torps optional rule.

All Ships Must Upgrade to Both Maneuverable and Variable Speed Torps

All players must pay the cost (page 59) to upgrade all torpedoes on their ships to take into account the effect both the Maneuverable and the Variable Speed Torps optional rules.

All Ships May Upgrade All Torps on a Ship to Maneuverable Torps

All players may pay the cost (page 59) to upgrade all torpedoes on a ship to gain the effects of the Maneuverable Torps optional rule.

Example: *A player is in a game and wants to take a Sorenson III. If he wants to make any of the torpedoes Maneuverable, he can, but he must*

choose to either upgrade all of the torps (4 Mk. 20 and 3 Mk. 10) for an additional cost of 19 points, or he cannot upgrade any of them.

All Ships May Upgrade All Torps of a Type on a Ship to Maneuverable Torps

All players may pay the cost (page 58) to upgrade all torpedoes of the same type on a ship to gain the effects of the Maneuverable Torps optional rule. The cost for each type of torpedo is paid separately, and players are free to have standard and Maneuverable torps on a ship provided they are not the same Mk. number.

Example: *A player who took a Sorenson III would have three options; he could upgrade the 4 Mk. 20 torpedoes for 14 points, the 3 Mk. 10s for 5 points, or he can upgrade both the Mk. 20s and the 10s for 19 points.*

All Ships May Upgrade Some of the Torps on a Ship to Maneuverable Torps

All players may pay the cost (page 58) to upgrade any of the torpedoes on a ship to gain the effects of the Maneuverable Torps optional rule. The cost for each torpedo is paid separately and players may have any combination of standard and Maneuverable torpedoes. Warhounds must still upgrade their torpedoes in blocks of ten.

Example: *A player taking a Sorenson III has a huge number of options. He could upgrade one of his Mk. 20 torpedoes for a cost of 4 points, two for a cost of 7, three for a cost of 11, or 4 for a cost of 14. He could additionally choose to upgrade one of his Mk. 10 torpedoes for a cost of 2 points, two for a cost of 4 points, or three for a cost of 5 points.*

All Ships May Upgrade All Torps on a Ship to Variable Speed Torps

All players may pay the cost (page 59) to upgrade all the torpedoes on a ship to gain the effects of the Variable Speed Torps optional rule.

The Next Millennium

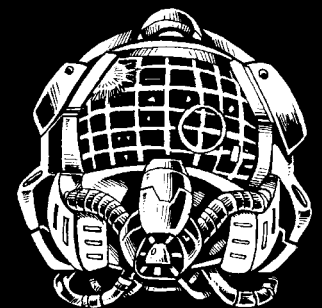

Example: A player takes a *Constellation*. If he wants to upgrade to Variable Speed torpedoes, he must upgrade all of the torpedoes on the ship. The ten Mk. 20 torpedoes would cost an additional 24 points. The ten Mk. 50s and ten Mk. 60s, however, have less range than normal torps under the variable speed option, so he would get a total of 62 points back on these torpedoes (20 from the Mk. 50s and 42 from the Mk. 60s). Thus, the *Constellation* would cost a net 38 points less under this option than under the standard rules.

All Ships May Upgrade All Torps of a Type on a Ship to Variable Speed Torps

All players may pay the cost (page 58) to upgrade all torpedoes of the same type on a ship to gain the effects of the Variable Speed Torps optional rule. The cost for each type of torpedo is paid separately, and players are free to have standard and Variable torps on a ship provided they are not the same Mk. number.

Example: A player takes a *Constellation*. He now has three options (since the *Constellation* has 3 types of torpedoes). He can upgrade the Mk. 20s for 24 points, upgrade the Mk. 50s for a 20 point savings, or upgrade the Mk. 60s for a 42 point savings. The player may choose any combination of these three options, or none of them. He could upgrade the Mk. 20s and the 60s for a net savings of 18 points, the Mk. 50s and 60s for a 62 point savings, etc.

All Ships May Upgrade Some of the Torps on a Ship to Variable Speed Torps

All players may pay the cost (page 58) to upgrade any of the torpedoes on a ship to gain the effects of the Variable Speed Torps optional rule. The cost for each torpedo is paid separately and players may have any combination of standard and Variable Speed torps. Warhounds must still upgrade their torpedoes in blocks of ten.

Example: A player takes a *Lance Electra* (why, we are really not sure...). He could choose to upgrade one Mk. 30 for a cost of 2 points or two for a cost of 3 points. He could also upgrade one Mk. 10 for a cost of 2 points or 2 for a cost of 4 points.

All Ships May Upgrade All Torps on a Ship to Either Maneuverable or Variable Speed Torps

All players may pay the cost (page 59) to upgrade all the torpedoes on a ship to gain the effects of either the Maneuverable or Variable Speed Torps optional rule.

Example: A player taking a *Hound* could either upgrade the two Mk. 20 torpedoes to Maneuverable for 7 points or he could upgrade to Variable Speed Torps for 5 points. He could not, however, pay the 15 points it would cost to take both options.

All Ships May Upgrade All Torps of a Type on a Ship to either Maneuverable or Variable Speed Torps

All players may pay the cost (page 58) to upgrade all the torpedoes of the same type on a ship to gain the effects of either the Maneuverable or the Variable Speed Torps optional rules. The cost for each type of torpedo is paid separately, and players are free to have standard, Maneuverable, and Variable Speed torpedoes on a ship provided they are not the same Mk. number.

All Ships May Upgrade Some of the Torps on a Ship to either Maneuverable or Variable Speed Torps

All players may pay the cost (page 58) to upgrade any of the torpedoes on a ship to gain the effects of either the Maneuverable Torps or the Variable Speed optional rules. The cost for each torpedo is paid separately and players may have any combination of standard, Maneuverable, and Variable Speed torpedoes. Warhounds must still upgrade their torpedoes in blocks of ten.

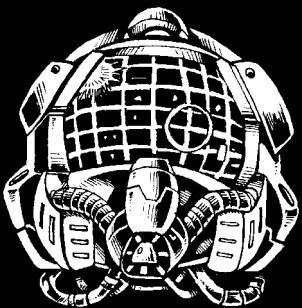

All Ships May Upgrade All Torps on a Ship to Maneuverable and Variable Speed Torps

All players may pay the cost (page 59) to upgrade all the torpedoes on a ship to gain the effects of the Maneuverable and Variable Speed Torps optional rules. Upgraded torpedoes do not have to have both effects.

Example: *A Hammer has four Mk. 20 torpedoes and four Mk. 10 torpedoes. Under this rule, the player may upgrade the Mk. 20s and the Mk. 10s to Maneuverable for 21 points, to Variable speed for 18 points, or take both options for 50 points.*

All Ships May Upgrade All Torps of a Type on a Ship to Maneuverable and Variable Speed Torps

All players may pay the cost (page 59) to upgrade all the torpedoes of the same type on a ship to gain the effects of the Maneuverable and Variable Speed Torps optional rules. Upgraded torpedoes do not have to have both effects. The cost for each type of torpedo is paid separately, and players are free to have standard tops and Maneuverable/Variable Speed torps on a ship provided they are not the same Mk. number.

Example: *A Hammer has four Mk. 20 torpedoes and four Mk. 10 torpedoes. Under this rule the player may upgrade the Mk. 20s to Maneuverable for 14 points, to Variable speed for 10 points, or take both options for 30 points. He could also upgrade the Mk. 10 torpedoes to Maneuverable for 7 points, to Variable Speed for 8 points, or take both options for 20 points.*

All Ships May Upgrade Some of the Torps on a Ship to Maneuverable and Variable Speed Torps

All players may pay the cost (page 58) to upgrade any of the torpedoes on a ship to gain the effects of the Maneuverable Torps and Variable Speed optional rules. Upgraded torpedoes do not have to have both effects. The cost for each torpedo is paid

separately and players may have any combination of standard and Maneuverable Torps with Variable Speed. Warhounds must still upgrade their torpedoes in blocks of ten.

Must verses May

The optional rules presented above come in two types: those that require a player to upgrade, and those that leave the upgrade as an option to the player. The “Must” rules are very simple to implement: everybody pays the cost. The “May” rules give players more freedom in ship selection, since players do not have to pay the upgrade cost. They can spend points on upgrades if they want it or buy better crews or more ships if they do not. The “May” rules do, however, cause more bookkeeping.

Also, when playing with the secrecy rules, the “May” options make getting close to a ship far more tense. Players have to wonder whether they can really close to range 13 on a ship and still have a chance to drop a decoy.

All, All Of A Type, or Some

Like the May verses Must considerations, these parameters allow players more freedom to customize their ships at the expense of more bookkeeping. The “All” rules are very easy to implement (either torpedo gets the upgrade or it does not). The “All of a Type” rules are almost as easy to use, but do allow players to pay for advantages on selected torpedo types. They are especially useful when using Warhounds, since the player can choose to avoid upgrading the Mk. 50s and above to Variable Speed (which actually slows these torpedoes down), while allowing Mk. 30s and below to be upgraded to Variable Speed (which makes these torpedo types more powerful). The “Some” rules give the most freedom, allowing players to mix and match standard, Maneuverable, and Variable Speed torpedoes at will, and, under the secrecy rules, makes identifying the exact composition of an opponent’s fleet very difficult. The “Some” rules, however, require intense bookkeeping and are not recommended for new players.

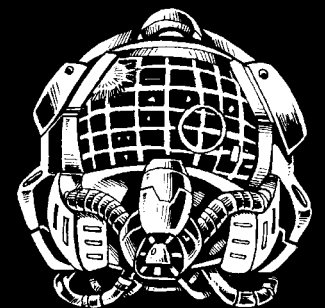

Silent Death

Torpedo Costs								
Mk.	Number	Base Cost	VS Cost	SM Cost	VSSM Cost	VS Upgrade	SM Upgrade	VSSM Upgrade
Mk. 10	1	1	3	3	6	2	2	5
	2	2	6	6	12	4	4	10
	3	3	9	8	18	6	5	15
	4	4	12	11	24	8	7	20
	6	6	18	17	36	12	11	30
	10	10	30	28	60	20	18	50
Mk. 20	1	2	4	6	9	2	4	7
	2	4	9	11	19	5	7	15
	3	6	13	17	28	7	11	22
	4	8	18	22	38	10	14	30
	6	12	26	34	56	14	22	44
	10	20	44	56	94	24	36	74
Mk. 30	1	3	4	8	11	2	5	8
	2	6	9	17	22	3	11	16
	3	9	14	25	33	4	16	24
	4	12	18	34	44	6	22	32
	6	18	27	50	67	9	32	49
	10	30	45	84	111	15	54	81
Mk. 40	1	4	4	11	11	0	7	7
	2	8	8	22	22	0	14	14
	3	12	12	34	34	0	22	22
	4	16	16	45	45	0	29	29
	6	24	24	67	67	0	43	43
	10	40	40	112	112	0	72	72
Mk. 50	1	5	3	14	10	-2	9	5
	2	10	6	28	20	-4	18	10
	3	15	9	42	30	-6	27	15
	4	20	12	56	40	-8	36	20
	6	30	18	84	60	-12	54	30
	10	50	30	140	100	-20	90	50
Mk. 60	10	60	18	168	60	-42	108	0
Mk. 70	10	70	21	196	70	-49	126	0
Mk. 80	10	80	24	224	80	-56	144	0
Mk. 90	10	90	27	252	90	-63	162	0
Mk. 100	10	100	30	280	100	-70	180	0

Alternative Torpedo, Warhound, Satellite, & Outpost Costs				
Ship	Base Cost	VS Cost	SM Cost	VSSM Cost
Aosho	764	762	1034	962
Constellation	806	768	1040	930
Fletcher	894	918	1038	1018
Longboat	921	922	1173	1133
Megafortress	482	526	536	606
Narwhal	623	682	731	828
Stingray	551	599	623	699
Taurus	41	41	84	84
Octopus	42	76	82	136
Dauntless	391	391	403	463
TBD Platform	210	210	253	253
Wakazashi	260	320	314	410

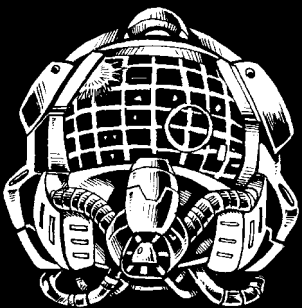

Alternative Torpedo Ship Costs

Ship	Base Cost	VS Cost	SM Cost	VSSM Cost
Avenger	78	108	110	158
Bat	42	50	49	62
Betafortress	216	291	293	295
Betafortress Alpha	218	292	295	297
Betafortress Beta	220	295	297	299
Betafortress NW	160	180	178	210
Black Widow	157	177	175	207
Blizzard	19	27	26	39
Blizzard II	18	26	25	38
Catastrophe	142	176	182	236
Conestoga	215	223	242	256
Crescent	55	65	64	80
Death Wind	60	70	74	90
Death Wind II	64	74	78	94
Drakar	121	125	125	131
Drakar Alpha	125	133	132	145
Eagle	170	198	215	261
Epping	119	125	141	151
Epping NW	119	125	141	169
Equalizer NW	123	143	141	173
Firebat NW	57	77	75	107
Glaive	106	106	120	120
Glaive II	107	107	121	121
Glaive III	104	104	118	118
Hammer	60	78	81	110
Havok	59	67	66	79
Hell Bender	32	35	37	40
Hell Bender II	33	36	44	55
Hell Bender K	26	31	33	41
Hornet NW	97	127	124	172
Hound	19	24	26	34
Iceberg	207	230	261	300
Javelin NW	131	151	149	181
Karttikeya	150	174	186	224
Lakshmi	83	91	90	103
Lance Electra	60	67	75	86
Lance Electra II	60	67	75	86
Marut	15	21	20	30
Nemesis	298	318	424	448
Pharsii	110	116	118	127
Pharsii II	120	126	128	137
Pit Viper	17	22	28	33
Praying Mantis NW	167	187	185	217
Rattler NW	70	90	88	120
Revenge	120	100	210	170
Revenge II	120	100	210	170
Salamander	66	76	77	93
Salamander II	66	76	77	93
Salamander NW	67	75	74	87
Scorpion	122	130	158	171
Seraph	121	127	137	146
Seraph II	121	127	137	146
Sorenson II	47	63	66	92
Sorenson III	68	84	95	115
Spider	129	163	169	223
Spirit Rider	18	22	22	28
Spirit Rider II	17	19	21	24
Star Raven	125	131	157	165
Star Raven Alpha	128	141	153	174
Stinger	18	18	32	32
Talon	33	35	35	38
Talon II	38	46	45	58
Teal Hawk	43	45	45	48
Teal Hawk II	47	55	54	75
Teal Hawk NW	50	52	52	55
Thunder Bird	25	35	36	52
Thunder Bird II	24	32	31	44
Thunder Bird NW	32	40	39	52
Varuna	120	132	131	150

The Next Millennium

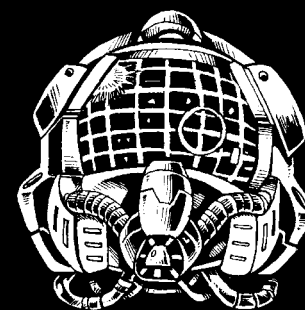

All Map Setup

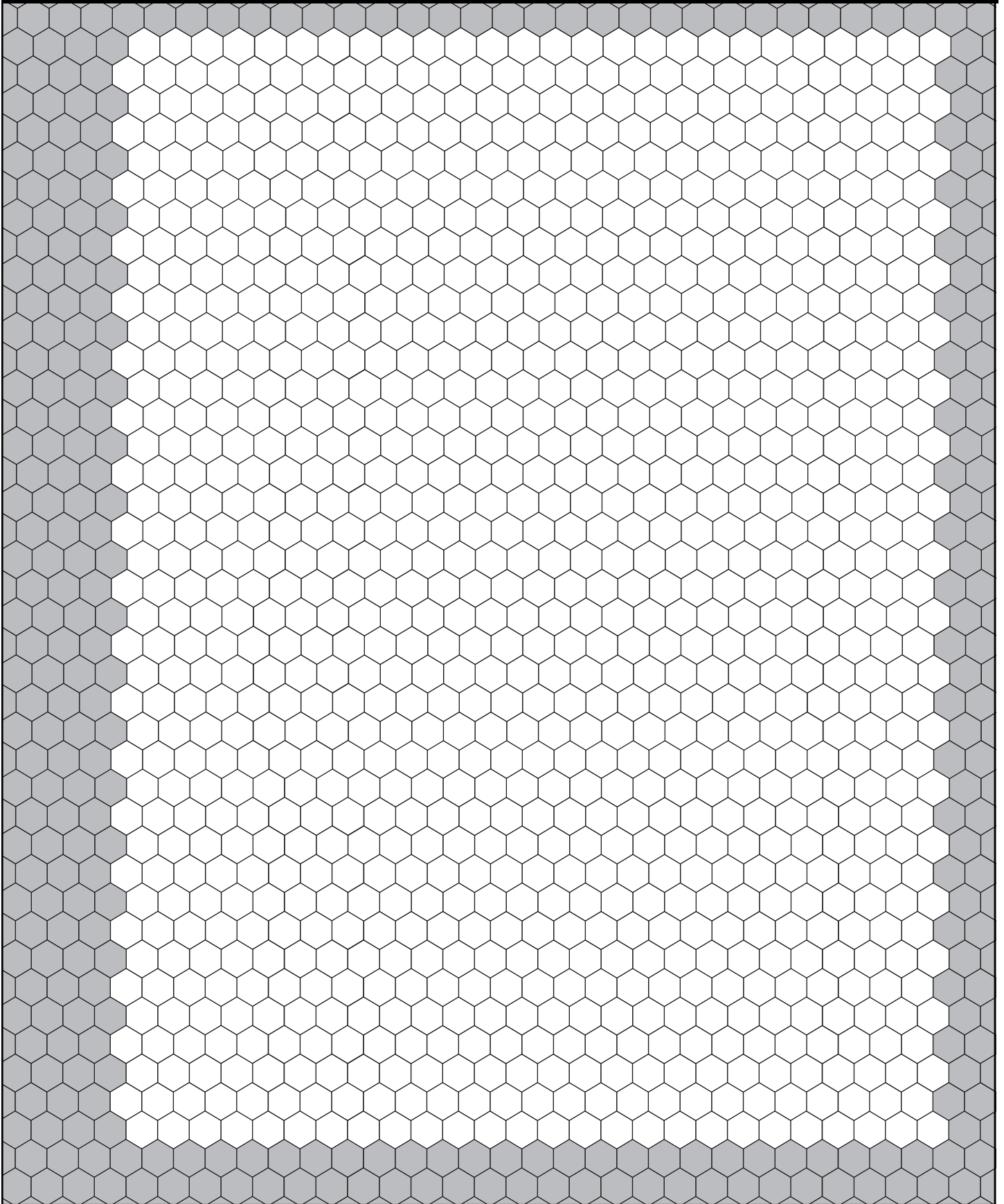

 =Standard Map

 =GeoHex Cloth Starmap



“THERE I WAS...”

“...screaming down on the wounded *Black Widow*,” he said, raising his voice over the noise of the crowd. “Splattergun fire streaked past me, but I shrugged it off and closed, letting loose with my Minigun. The slugs ripped wide the holes my missiles had already made in their sorry hide. As they ejected, I opened the com for one last taunt at the *Widow’s* poor, misguided crew...”

“Tell us—tell us what you said to them!” begged the crowd.

He smiled, savoring their undivided attention.

“I said: ‘Like my flight instructor always warned me, you *Luches* dogs...No matter the ship—never ever leave your wing man.’”

FIGHTER™ TACTICS MANUAL

The *Fighter Tactics Manual* is a training guide for the new *Silent Death* player and also an enlightening refresher for battle hardened veterans.

The *Fighter Tactics Manual* includes:

- 3 new Fighter Wings
- 3 new scenarios
- An easy-to-use torpedo dodging chart
- Guidelines on formation flying
- Tips on assigning crew and picking forces
- Kill zone diagrams for variable speed and maneuverable torpedoes
- New prices and optional rules for variable speed and maneuverable torpedoes
- Six new Space Fighters:
 - Bat –Black Widow –Nemesis
 - Shark –Chupacabra –Stinger

SILENT DEATH™
THE NEXT MILLENNIUM



To use this product, you must have *Silent Death: The Next Millennium™*.



ICE, Inc.
P.O. Box 1605
Charlottesville, VA 22902 USA

ISBN# 1-55806-210-5 ICE 7.00

This specially-priced PDF is available through the ICE Online Store at www.ironcrown.com