

STREET SAMURAI

CATALOG



FASA CORPORATION

REVISED FOR SHADOWRUN II

TOM DOWD

ARES CATALOG WINTER 2050

1

ARES SECURITY

2

WIREMASTERS

3

ACCESSORIES

4

ARES WINTER CATALOG 2050

Our regular subscribers will notice quite a difference between this catalog and our last. As a direct result of input from our customers, we've been able to streamline enormously. We've taken their suggestions and transformed this catalog into a primary source for quality weapons and equipment. Every item on these pages has passed the most rigorous tests. That's why when you buy from Ares America, you know you're buying the best.

We've also begun the best money-back guarantee in the business. All our equipment has a flat 90-day warranty. No questions asked. On top of that, you still get our phenomenal 60 days or 1,000 rounds warranty on light firearms and 30 days or 10,000 rounds on heavy firearms. The best in the business, because you demanded it.

—Nathaniel Naidich, Director of Sales, Ares America

Ares America is a division of Ares Arms, a wholly owned subsidiary of Ares Macrotechnology Incorporated, Detroit Michigan, UCAS.

All items in this catalog are available, by special order, in a hypo-allergenic form for roughly 150 percent of the listed price.

>>>>>[Can you believe that guarantee drek, chummers? My buddy Wedge burned at least 20,000 rounds in his Valiant the first week he had it! Now admittedly, he's a bit intense...

As anyone can see, this is the current Ares catalog. Normally available only to subscribers, I've posted it here on the public databoard for all to see. Nothing super-special in this part, but just wait until you get to Section Two! (That's the part that's supposed to be available only to licensed police or security organizations with a valid credit rating.) The first part'll get you drooling, but Section Two will leave you wriggling on the floor.

This posted copy isn't protected, so feel free to comment as you like. All you jokers who read this, beware! I've got no control over who says what in this file once it's up, so not everything you read may be chip-truth. But then again, you never know....]<<<<<

—FastJack <14.34:27 10-07-50>

ORDER HERE

PAID

SALESPERSON

SECTION

1

ARES

MONOFILAMENT SWORD

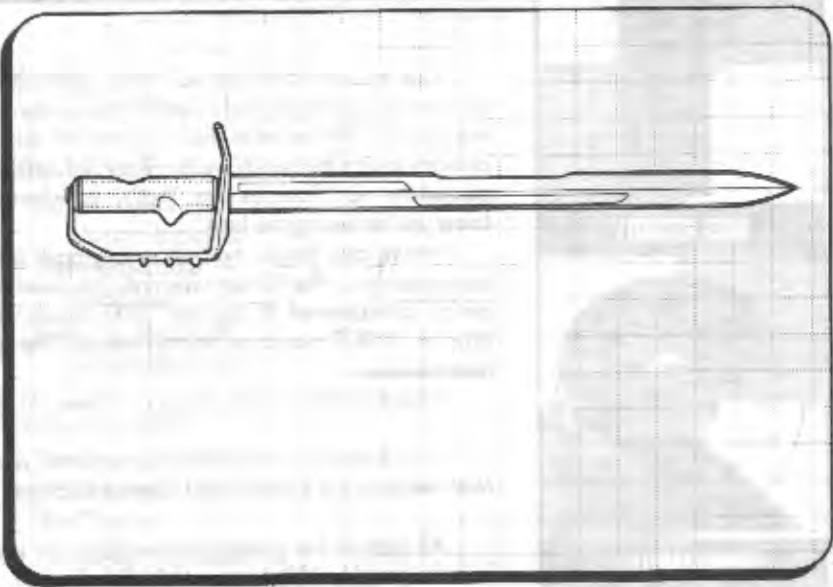

- Cuts virtually anything like butter!
- Not as clumsy or random as a monofilament whip!

Because you demanded it, Ares America is making the Monofilament Sword, an incredible piece of weapon technology, available for the first time. We've taken a precision-crafted blade and grafted to it a piece of cutting-edge tech in the form of a monofilament line adhered along a sword edge. Not only do you get the balance and excellence of an Ares sword, but you get the sharpness of a monofilament line leading the way!

| | Concealability | Reach | Damage | Weight | Cost |
|--------------------|----------------|-------|------------|--------|--------|
| Monofilament Sword | 3 | 1 | (Str + 3)M | 2 | 1,000¥ |



>>>>>[Don't buy the hype, kiddies. Remember, this ain't a real monomolecular line we're talking about here. Sure it may be monofilament, but so what? My sneaker lace is monofilament, too, but you don't see me lopping any limbs off with that!]<<<<<<
 —Hermes <08:17:30/11-28-50>

LASER CRESCENT AXE

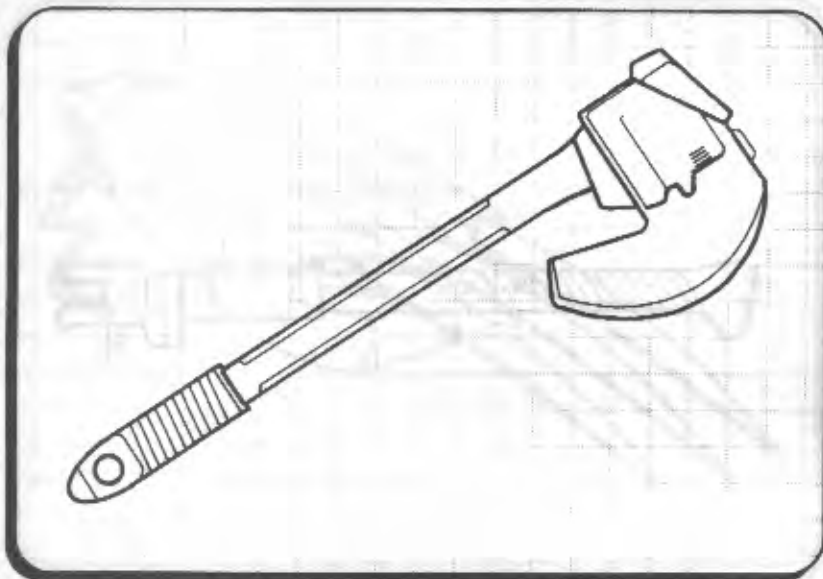

- An industrial-strength, welding laser personal combat weapon!
- Safer than a monowhip and just as deadly!

Here's one for Mr. Ripley. Designed by Centurion Industries for use against certain types of Awakened Critters, the Laser Crescent Axe carries a self-focusing, multi-track welding laser in a crescent-shaped mounting. The crescent shape keeps the weapon from snagging, and the laser ensures that there's nothing left to snag on! Literally on the cutting edge of technology!

| | Concealability | Reach | Damage | Weight | Cost |
|-----------|----------------|-------|--------|--------|--------|
| Laser Axe | 2 | 1 | (Str)S | 5.2 | 3,500Y |

>>>>>[Friend of mine had the opportunity to field test this weapon, and though the effect is extreme, the odds in favor of knocking the laser out of alignment are pretty high. When he had it, the axe seemed to be down for repairs more often than it was working properly. Seemed that every third of fourth hit on armor knocked it out.]<<<<<<

—Metallic Marauder <23:32:45/11 25-50>

ORDER HERE

SALESPERSON



ORDER HERE



SALESPERSON

SECTION



AZ-150 SUPER STUN BATON

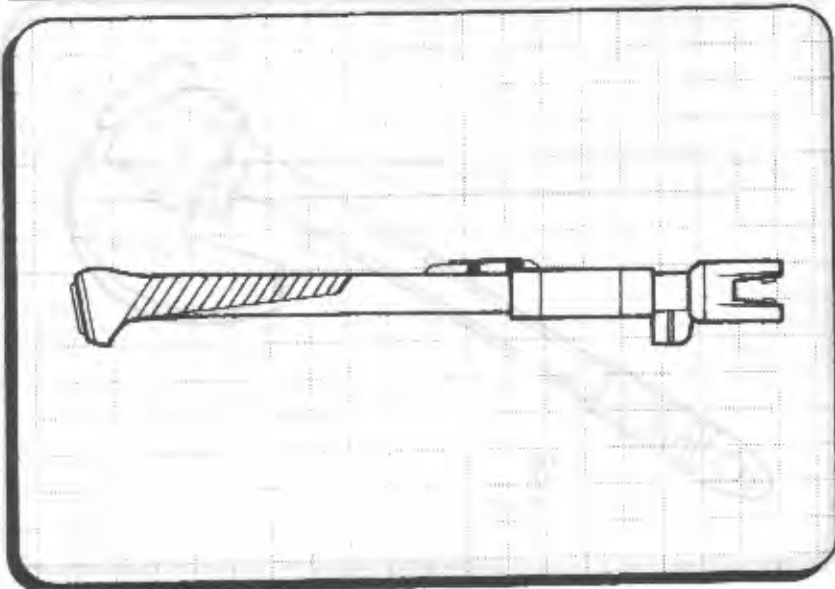

- For that one-shock stop!
- More punch than the standard stun baton!

At the request of Law Enforcement agencies worldwide, Defiance Industries has manufactured a powerful new Stun Baton designed especially for use against large assailants. High-energy lithium capacitors deliver more than enough amps for your security needs!

| | Concealability | Reach | Damage | Weight | Cost |
|------------------|----------------|-------|----------|--------|--------|
| Super Stun Baton | 5 | 1 | 8S Stun* | 1 | 1,500¥ |

*See page 103 of SR11 for stun weapon rules. Usable 12 times per 1 hour recharge.



>>>>>[Specifically designed against large opponents...? Gee, I wonder who they could be referring to?]<<<<<<
 —Chuck-Chuck Razool <18:17:47/11-17-50>

FOREARM SNAP-BLADES

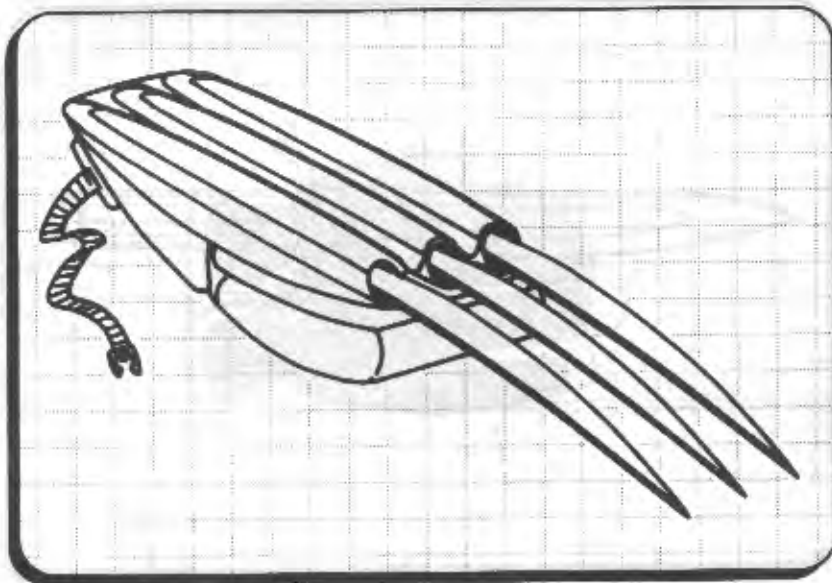

- Cyberspurs, without the after-effects!
- Muscle-triggered action!

Need that extra cyberspur edge, but can't afford the cost? Leetol Industries of Belgium has come up with the answer! These spur-blades are mounted in external forearm sheaths and respond to muscle-movement commands. POP!— they're out! SLITCHT!— they're retracted, and your opponent doesn't realize it until it's too late!

| | Concealability | Reach | Damage | Weight | Cost |
|------------|----------------|-------|--------|--------|------|
| Snap-Blade | 7 | 0 | (Str)M | 1.5 | 850¥ |

>>>>>[Be careful with these, chummers. They don't come with the kind of bone reinforcing that real cyberspurs do, so watch out for those rotational and leverage-based moves when you've got resistance. Odds are a bone will snap before the blade does.]<<<<<
 —Findler-Man <21:45:02/01-03-51>

ORDER HERE



ORDER HERE

SALESPERSON

SECTION

1

SURVIVAL KNIFE

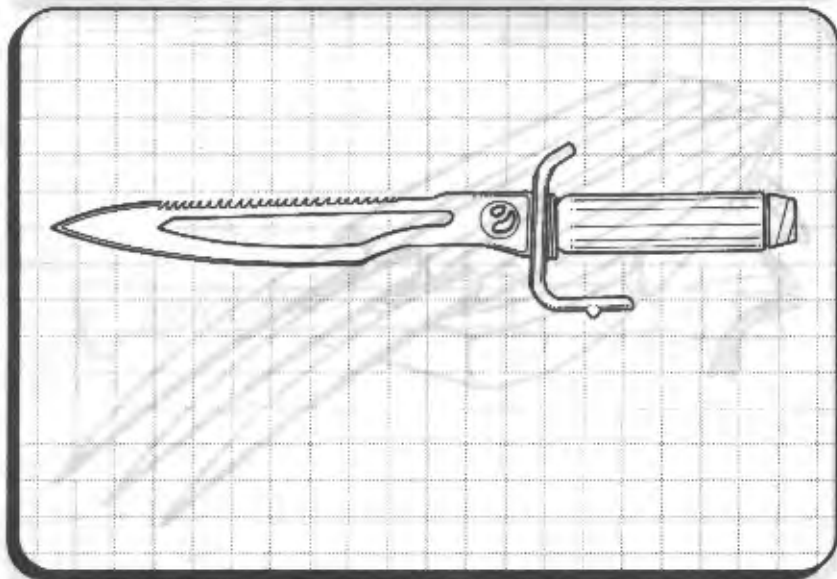

- The perfect knife for that urban jungle you call home!
- Not only the wickedest blade on the market, but comes with a small compass, micro-lighter, night-glow stick, and trauma patch in the handle!

Manufactured to UCAS Marine specifications, the Redstone Survival Knife is finally being made available to the general public. Without a doubt, the finest-quality workmanship on the market today.

| | Concealability | Reach | Damage | Weight | Cost |
|----------------|----------------|-------|------------|--------|------|
| Survival Knife | 6 | 0 | (Str + 2)L | .75 | 450¥ |



SHOCK GLOVE

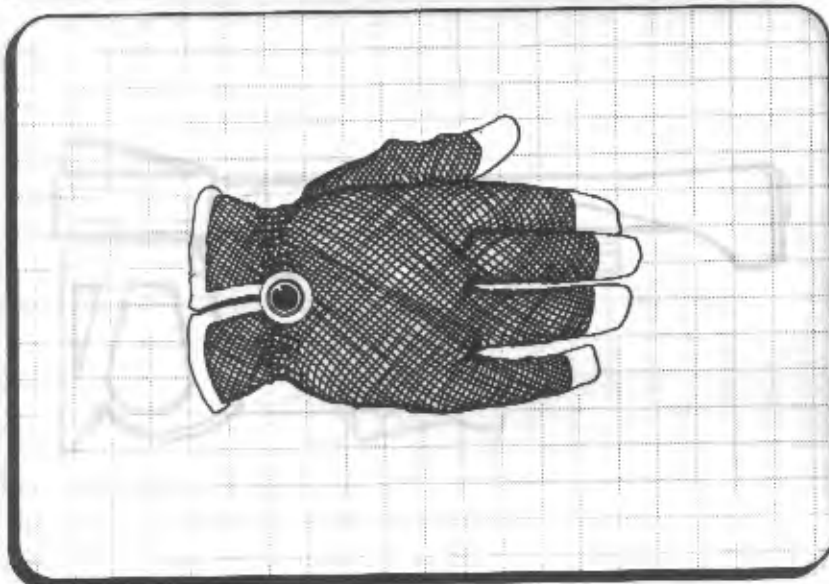

- Perfect for when the kid gloves come off and the nasty stuff goes on!
- Impact-triggered, it discharges only when you hit!

Based on stun baton technology, the Reinco Shock Glove is a black, non-conducting plas-fabric interlaced with a partitioned wire mesh to provide the greatest chance for shock on impact. Flat battery/capacitors mount in a special vambrace for added convenience.

| | Concealability | Reach | Damage | Weight | Cost |
|-------------|----------------|-------|----------|--------|------|
| Shock Glove | 9 | 0 | 75 Stun* | .5 | 950¥ |

*See page 103 of SR11 for stun weapon rules. Usable 8 times per 1 hour recharge. Fist damage reduced to (Str - 1)M when worn, and not usable with Hand Razors.

ORDER HERE



ORDER HERE

PAID

SALESPERSON

SECTION

1

RES

COMBAT AXE

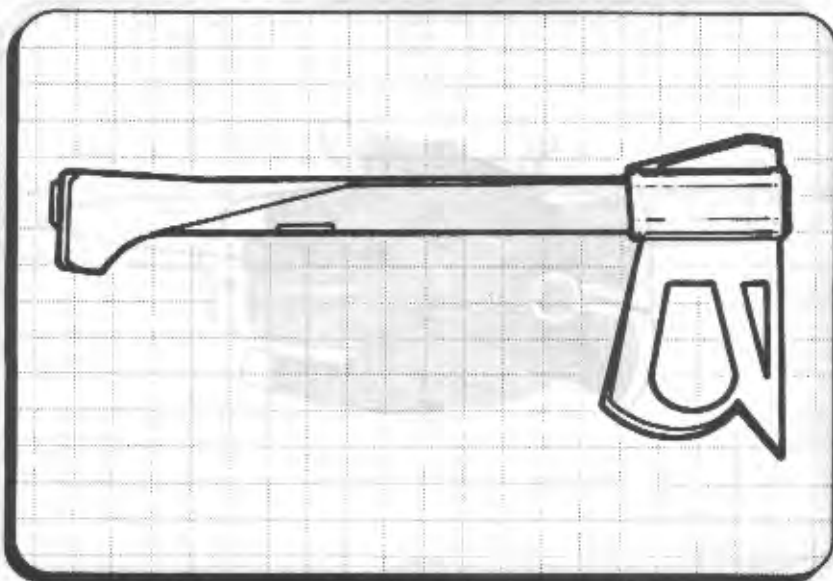

- If you're tired of weapons breaking on your opponent's armor, this one's for you!
- Made of a tungsten alloy, it hits harder than a sword, but weighs only slightly more!

Designed after a year of street research, the Wallacher Combat Axe is the apex of current combat axe technology. Its single carbide blade is guaranteed never to dull, and it comes with a spring-loaded thrusting point concealed in the handle. Perfect for the ultimate surprise!

| | Concealability | Reach | Damage | Weight | Cost |
|-----------------|----------------|-------|------------|--------|------|
| Combat Axe | 2 | 2 | (Str)S | 2.0 | 750¢ |
| Thrusting Point | — | 0 | (Str + 2)L | — | — |



>>>>[I think these guys have been slotting too many "Neil, the Ork Barbarian" simsense chips.]<<<<<
 —Le Bleu <04:32:12>/01-04-51>

BOW ACCESSORY MOUNT

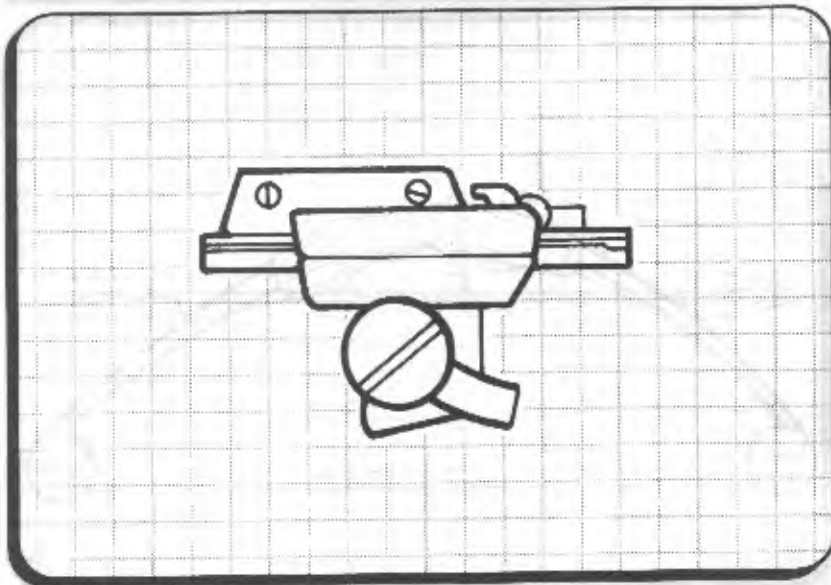

- Allows the mounting of pistol accessories on your bow!
- Lightweight, yet durable!

With this neat little gadget from Peterson Enterprises of Seattle, owners of various brands of bows can mount them with commonly available pistol accessories. Mountable accessories include laser sights, imaging scopes, and smartgun adapters.

| | Concealability | Reach | Damage | Weight | Cost |
|---------------------|----------------|-------|--------|--------|------|
| Bow Accessory Mount | -1 | - | - | +1 | 100Y |



ORDER HERE

PAID

SALESPERSON

SECTION

1

RES

COMPOUND BOW SYSTEM

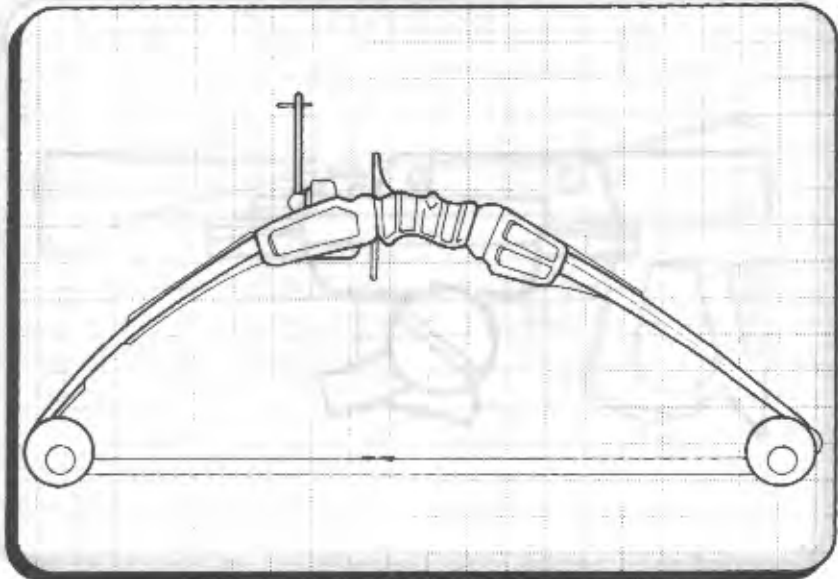

- Designed for you, the ultimate hunter!
- Uses the latest in strength-amplification technology to increase its power-to-velocity ratio over the top!

Manufactured from state-of-the-art materials and benefitting from 1,000 hours of computer-aided design, the Ranger X Compound Bow propels your arrow at a higher velocity than any other bow in its weight class. Matched with the precision Ranger Arrows shown below, this will give you the best hunting you've ever had!

| | Concealability | StrMin | Reach | Damage | Weight | Cost |
|--------------|----------------|--------|-------|------------|--------|---------------|
| Compound Bow | 2 | 2+ | - | (Str + 4)M | 1.5 | 120¥ x StrMin |



>>>>>[Elves of the world—unite!]<<<<<<
 —Chuck Chuck Razool <19:02:34/11 17 50>
 >>>>>[Keep it up, drek-face...]<<<<<<
 —Winger <06:17:41/11-22-50>

PRECISION ARROWS

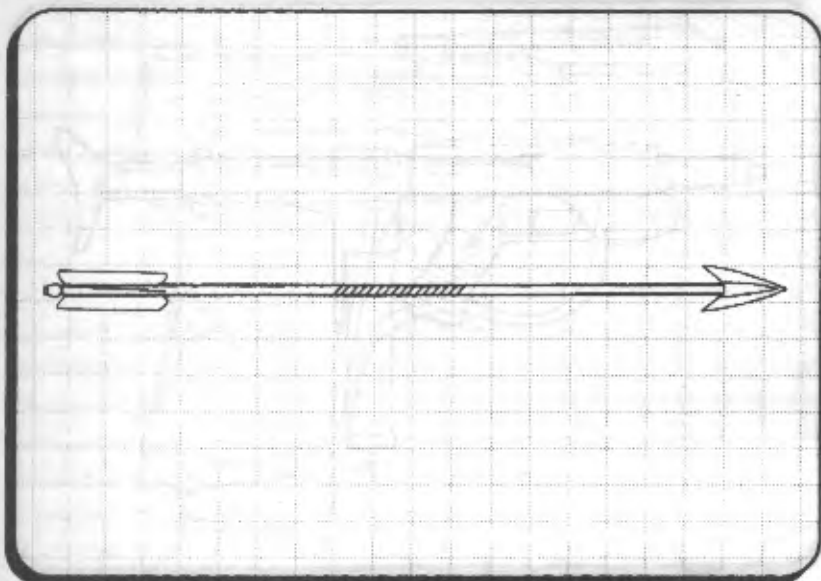

- The perfect match for the Ranger X Compound Bow!
- Lighter and more durable than any arrows on the market today!

Formed from a new polymer, these Precision Arrows carry 15 percent more punch than other arrows of the same weight. Get your one-shot take-downs carrying a lighter load!

| | Concealability | Reach | Damage | Weight | Cost |
|------------------|----------------|-------|--------|--------|------|
| Precision Arrows | 4 | — | as bow | .08 | 18¢ |

ORDER HERE

| | | | |
|---|-------------|-----|------|
| ¥ | ☪ | 100 | PAID |
| ✈ | ☪ | ✉ | 🚚 |
| 🔧 | 🔧 | 👤 | ☪ |
| 👤 | SALESPERSON | | |



ORDER HERE

SALESPERSON

SECTION

CRUSADER MACHINE PISTOL

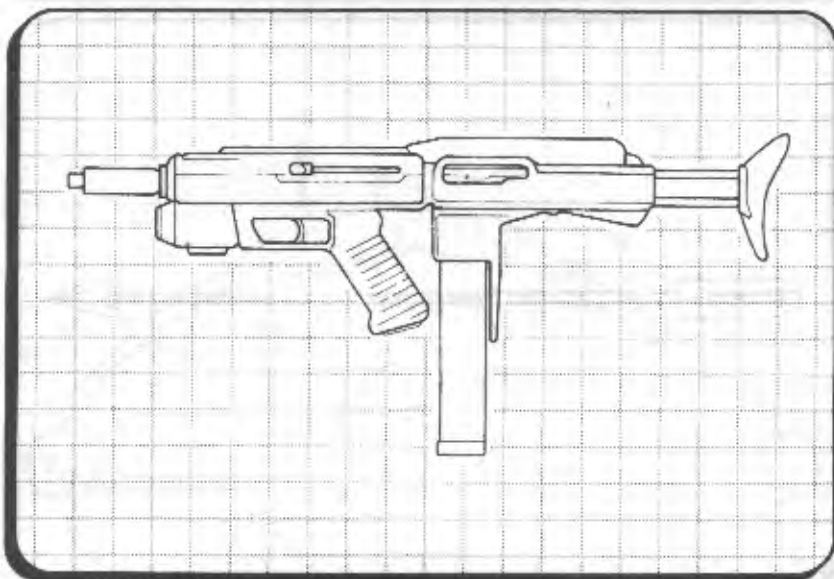

- Designed by Ares Arms for durability and concealability!
- Integral gas-vent recoil reduction system!

The Ares Crusader represents the pinnacle in machine pistol technology. Only slightly larger than a conventional pistol, the Crusader is capable of automatic fire and carries an extended clip that should make some assault-rifle owners jealous! Comes with an integral Wagner gas-vent recoil system.*

| | Type | Conceal | Mode | Ammo | Damage | Weight | Cost |
|----------|-------|---------|-------|--------|--------|--------|------|
| Crusader | Light | 6 | SA/BF | 40 (c) | 6L | 3.25 | 950¥ |

*Wagner provides Gas-Vent 2 recoil compensation.



>>>>>[Wonderful. Now I can flatten light ammo against body armor faster than ever before.]<<<<<<

—Steel Lynx <22:18:01/12-16-50>

LIGHT FIRE 70

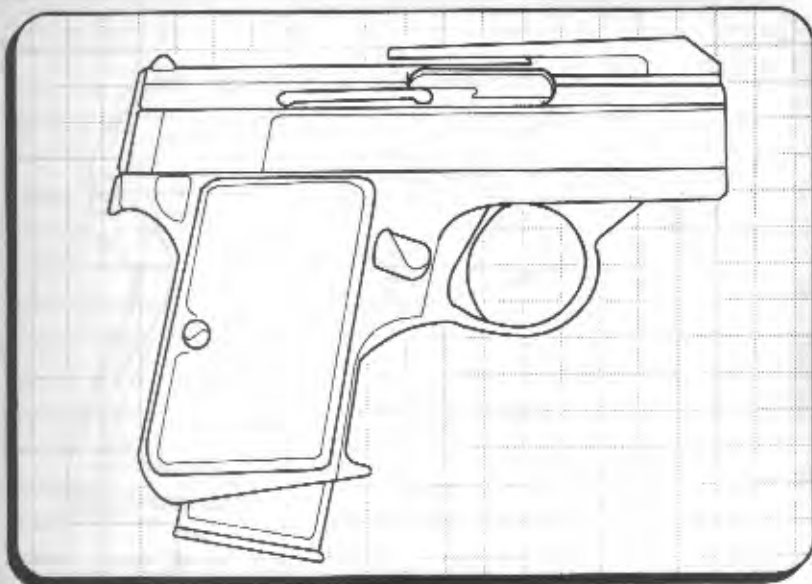

- Patented clip design gives you more bullets in the same space!
- Ergonomic design improves concealability!

The Ares Light Fire 70 is your choice for self-defense and light security work. Weighing in at only 1 kilogram, this pistol is perfect for times when firepower is necessary, but excess baggage is not. The specially constructed silencer is 50 percent lighter than any other model on the market.

| | Type | Conceal | Mode | Ammo | Damage | Weight | Cost |
|---------------|-------|---------|------|--------|--------|--------|------|
| Light Fire 70 | Light | 5 | SA | 16 (c) | 6L | 1 | 475¥ |
| Silencer* | | -1 | — | — | — | .1 | 650¥ |

*Works only with the Light Fire 70 pistol.



>>>>[The silencer's only good on the Light Fire, and it won't last beyond three shots.]<<<<<

—Toshi <18:21:45/11-07-50>



ORDER HERE



SALESPERSON

SECTION

1



PREDATOR II

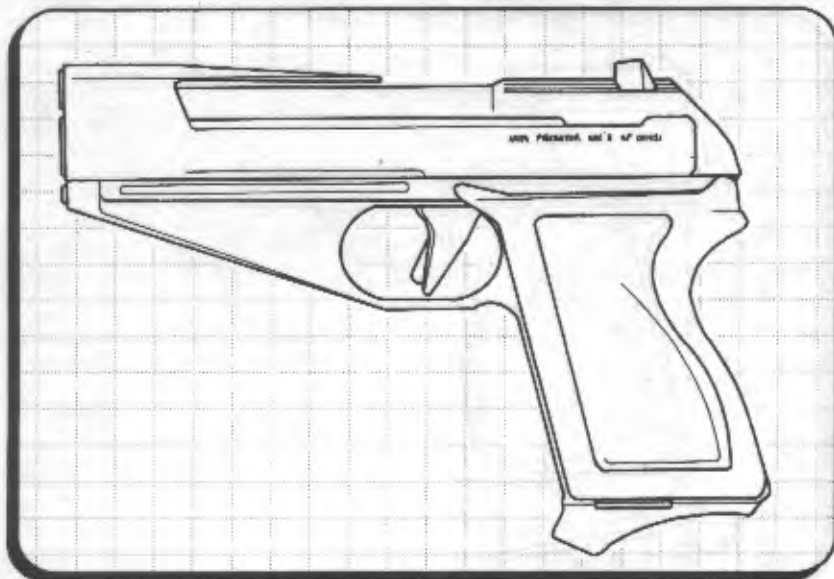

- The premier heavy pistol, now better than ever!
- Includes Integral Smartlink!

How can the best heavy pistol in the world work even better? That's the question Ares Arms asked their R&D department, and the Predator II is their answer. Redesigned, the Predator now includes the integral Ares Smartgun Link. You've got a new contender for man's best friend.

| | Type | Conceal | Made | Ammo | Damage | Weight | Cost |
|-------------|-------|---------|------|--------|--------|--------|------|
| Predator II | Heavy | 4 | SA | 15 (c) | 9M | 2.5 | 550¥ |



BERETTA 200ST



- Capable of burst fire!
- An incredible 26-shot magazine!
- Redefines the concept of light service pistol!

The pistol that all the military data-faxes are screaming about. The Beretta Model 200ST is everything you've heard and more. Capable of burst fire, this pistol jams as much firepower into a small frame as any other light service pistol currently available. Plus, the 26-shot magazine reduces the chance of being caught short at those critical moments. Equipped with detachable pistol shoulder-stock.*

| | Type | Conceal | Mode | Ammo | Damage | Weight | Cost |
|-------------|-------|---------|-------|--------|--------|--------|------|
| Model 200ST | Light | 4 | SA/BF | 26 (c) | 6L | 2 | 750¥ |

*Shoulder Stock gives 1 point of Recoil Compensation. Can fire one (1) burst-fire as a Complex Action.



ORDER HERE



SALESPERSON

SECTION



ULTRA-POWER

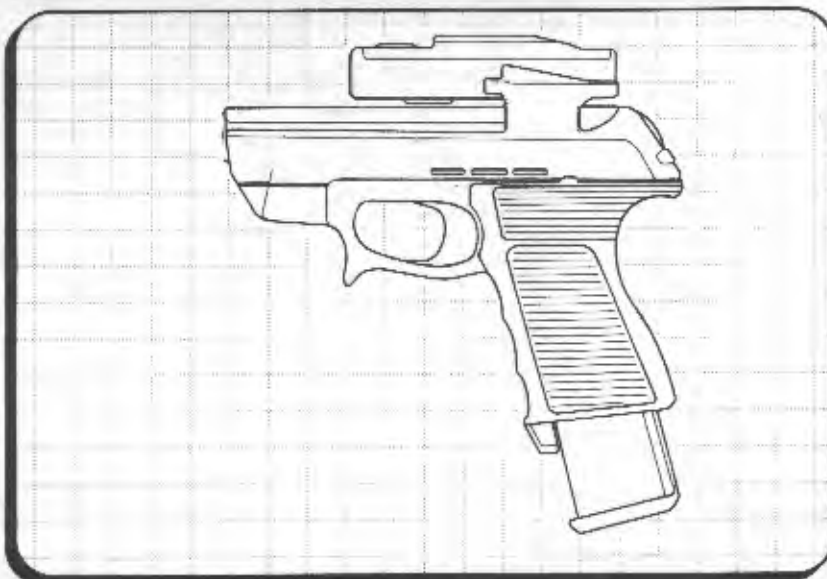

- Improved design!
- Integral laser sight!

This new and improved version of the popular Browning Max-Power contains a revolutionary mechanism that significantly reduces the size of the weapon. The integral laser sight is the battle-proven LasSys XMS design that is manufacturer-guaranteed not to fail.

| | Type | Conceal | Mode | Ammo | Damage | Weight | Cost |
|-------------|-------|---------|------|--------|--------|--------|------|
| Ultra-Power | Heavy | 6 | SA | 10 (c) | 9M | 2.25 | 525¥ |



SCORPION MACHINE PISTOL

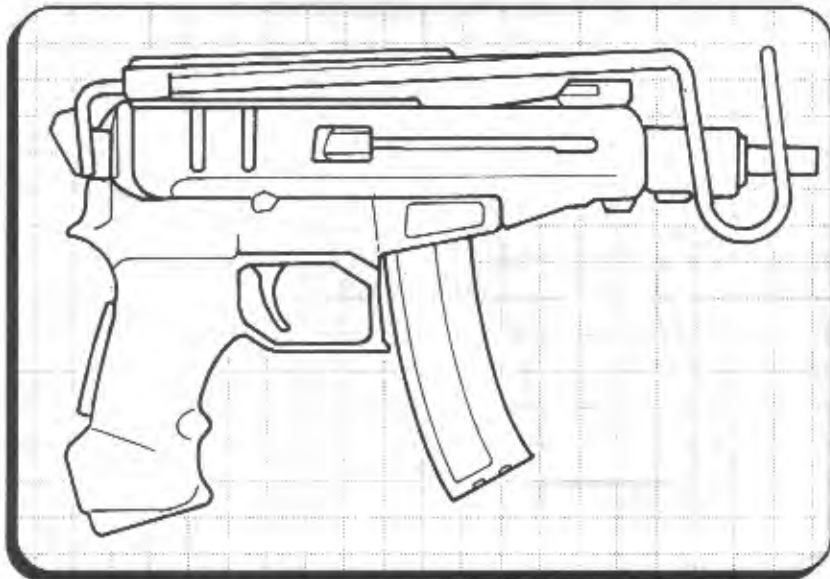

- Combines light weight with full-auto capability!
- Comes with integral folding stock!

This design by Ceska combines a submachine gun's rate-of-fire with the weight and concealability of a light service pistol. It comes equipped with an integral folding stock* for added recoil-reduction and it can carry all conventional pistol accessories. The optional extended-shot clip is also sure to please. Don't leave home without it!

| | Type | Conceal | Mode | Ammo | Damage | Weight | Cost |
|----------------|-------|---------|-------|--------|--------|--------|------|
| Black Scorpion | Light | 6 | SA/BF | 25 (c) | 6L | 2.75 | 750¥ |
| Black Scorpion | Light | 5 | SA/BF | 35 (c) | 6L | 3.0 | 850¥ |

*The Folding Shoulder Stock gives 1 point of Recoil Reduction.



ORDER HERE

SALESPERSON

SECTION

CESKA vz/120

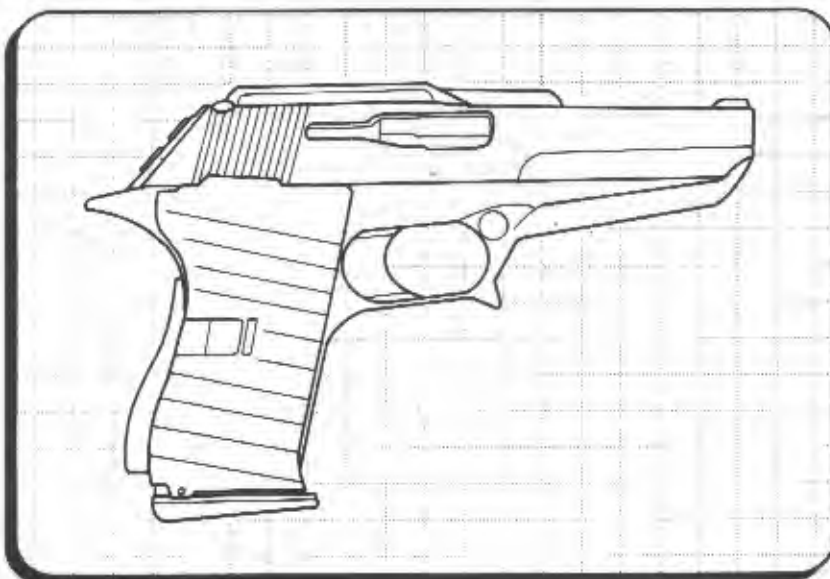

- East European styling and craftsmanship!
- The sidearm of choice of the Czech Mechanized Command!

This Czech pistol, manufactured by Ceska Zbrojovkain Prague, is the premier East European light service pistol. Imported by Ares America, it has been rated by several experts as the best pistol of its class in the world.

| | Type | Conceal | Mode | Ammo | Damage | Weight | Cost |
|--------------|-------|---------|------|--------|--------|--------|------|
| Ceska vz/120 | Light | 7 | SA | 18 (c) | 6L | 1 | 500¥ |



>>>>>[Gosh, such humility! Thank you, Ares America, for bringing us this wonderful pistol!]<<<<<<
 —White Tiger <27:34:48/01-03-51>
 >>>>>[You're welcome.]<<<<<<
 —Nightfire <13:56:27/01-17-51>
 >>>>>[Nightfire: You've really earned your pay this week, haven't you, chummer? It must be nice actually having an office. Got a nameplate on your desk, too?]<<<<<<
 —FastJack <07:23:09/01-19-51>

MANHUNTER

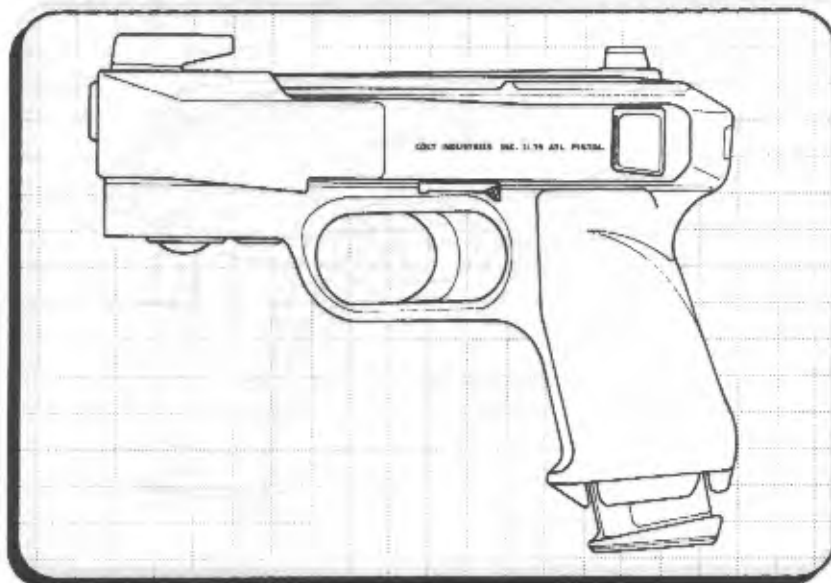

- Designed for Colt by Andrea McBaine, world-famous Bounty Hunter!
- Features extended magazine and integral laser sight.

Colt explodes back into the heavy handgun market with the vicious Manhunter! Sleek and deadly, this heavy pistol is designed for ultimate reliability under the most adverse of conditions. The weapon was designed by famous Bounty Hunter Andrea McBaine, and underwent more than a year of field testing before she pronounced it ready for the market.

| | Type | Conceal | Mode | Ammo | Damage | Weight | Cost |
|-----------|-------|---------|------|--------|--------|--------|------|
| Manhunter | Heavy | 5 | SA | 16 (c) | 9M | 2.5 | 425¥ |



ORDER HERE

SALESPERSON

SECTION

LD-120



- Precision craftsmanship from an Israeli design!
- Comes with integral mini-laser!

Count on Seco to take the fantastic, but decades old, Israeli LD-100 design and rework it for modern times. Not only does it fire today's caseless high-compression rounds, but it also mounts an integral mini-laser for faster targeting! The sturdy flat-black macroplastic casing gives it that lethal look in such demand.

| | Type | Conceal | Mode | Ammo | Damage | Weight | Cost |
|-------------|-------|---------|------|--------|--------|--------|------|
| Seco LD-120 | Light | 5 | SA | 12 (c) | 6L | 1 | 400¥ |



>>>>[Careful about this one, jokers. I found out the hard way that the "mini-laser" is good out to only about 20 meters. Can't really handle smoke, either.]<<<<<

—Fidler-Man <22:31:03/12-17-50>

>>>>[Truthfully? The one I own works fine out to a good 40-45 meters. Perhaps you have a damaged focusing system?]<<<<<

—Winger <09:47:54/12-23-50>

SELF-DEFENDER

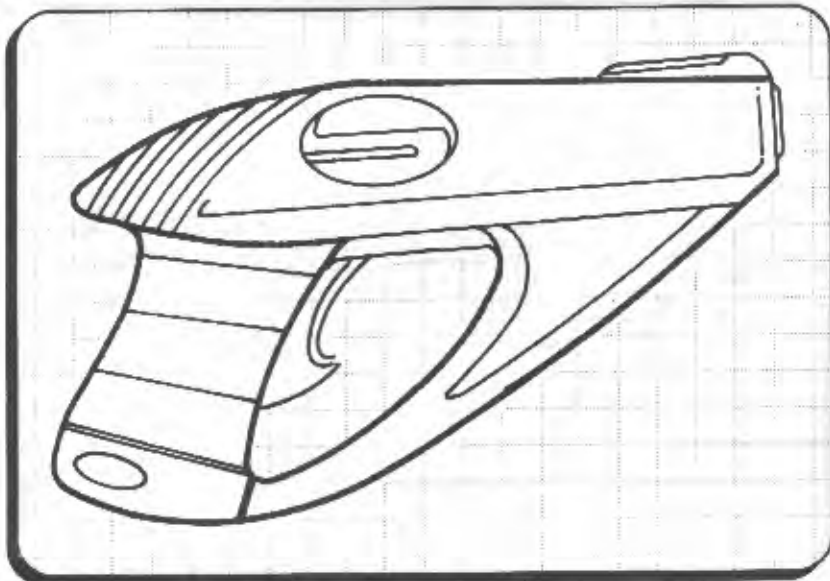

- Lightweight, sleek design!
- Perfect for concealment or undercover work!

The Tiffani Self-Defender, manufactured by Fichetti Firearms, answers the need of those who wanted a little more styling in their self-defense firearms. Small and easily concealable, it combines deadliness with a lethal fashion sense.

| | Type | Conceal | Mode | Ammo | Damage | Weight | Cost |
|------------------|----------|---------|------|-------|--------|--------|------|
| Tiffani Defender | Hold-out | 8 | SS | 4 (c) | 4L | .5 | 450¥ |



ORDER HERE



SALESPERSON

SECTION



CMDT COMBAT GUN

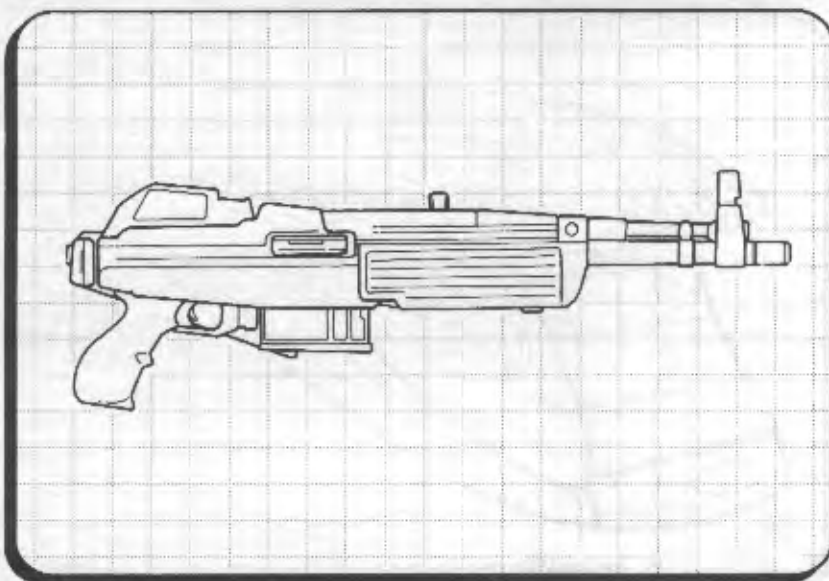

- Rated best new weapon at Desert Wars 7!
- The combat shotgun of militaries worldwide!

Maybe the best combat shotgun on the market today. The Mossberg CMDT Combat Gun is a proven winner in every climate, in nearly every situation. Comes with integral laser sight, and the model SM variant has an internal smartgun link.

| | Type | Conceal | Mode | Ammo | Damage | Weight | Cost |
|------------------|---------|---------|-------|-------|--------|--------|--------|
| Mossberg CMDT | Shotgun | 2 | SA/BF | 8 (c) | 9S | 4.25 | 1,400¥ |
| Mossberg CMDT/SM | Shotgun | 2 | SA/BF | 8 (c) | 9S | 4.5 | 1,900¥ |



>>>>[Desert Wars. Now there's a concept. Let's get all the corporations to field small armies and blow the drek out each other in a nuclear-blasted wasteland. Guaranteed ratings grabber.]<<<<<<
 —Stinger-Six <08:23:45/12-09-50>

100 SPORT RIFLE

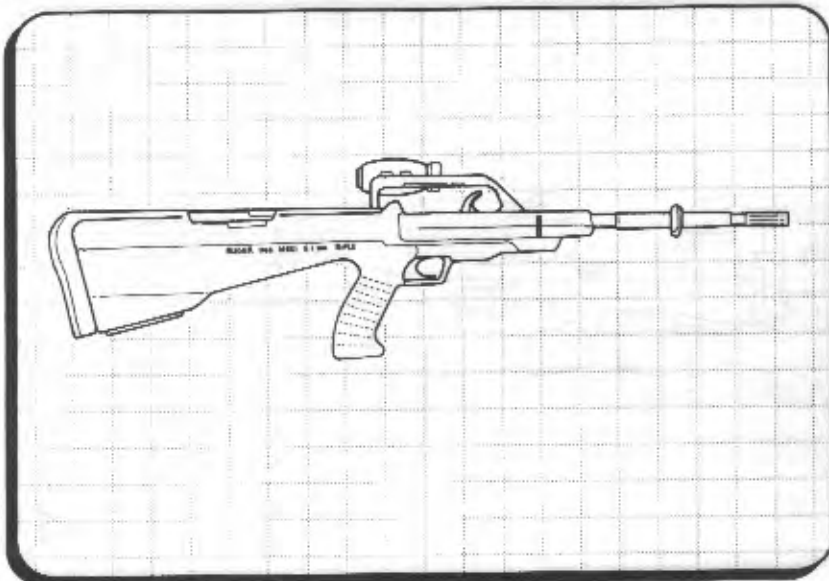

- The choice of professional hunters.
- Integral imaging scope.

A precision hunting weapon perfect for all environments. Its sturdy wood and high-impact plastic casing ensures dependability, even in the foulest of weather. Comes with an integral Mag-3 imaging scope.

| | Type | Conceal | Mode | Ammo | Damage | Weight | Cost |
|-----------|----------|---------|------|-------|--------|--------|--------|
| Ruger 100 | Sporting | 2 | SA | 5 (m) | 7S | 3.75 | 1,300¥ |



ORDER HERE

PAID

SALESPERSON

SECTION

1

RES

MA 2100 SNIPING RIFLE

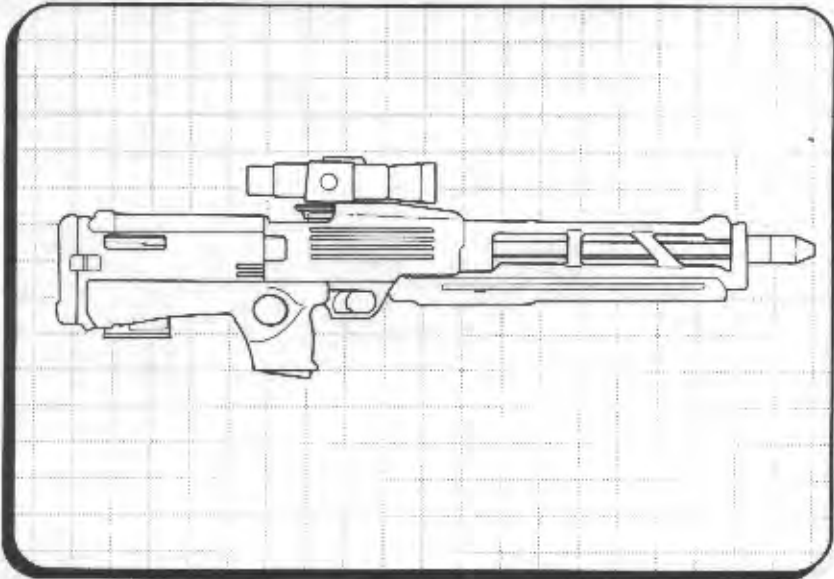

- The sniping rifle of the Confederated American States!
- Integral smartgun link!

This weapon is the sniping rifle that just won the rigorous CAS Army sniper rifle competition! Designed to military specifications, the Walther is reliable and free of the design instabilities common to other weapons of the type. The professional's choice!

| | Type | Conceal | Mode | Ammo | Damage | Weight | Cost |
|--------------------|--------|---------|------|-------|--------|--------|--------|
| Walther MA 2100 | Sniper | NA | SA | 8 (m) | 14S | 4.5 | 6,500¥ |



BERETTA MODEL 70

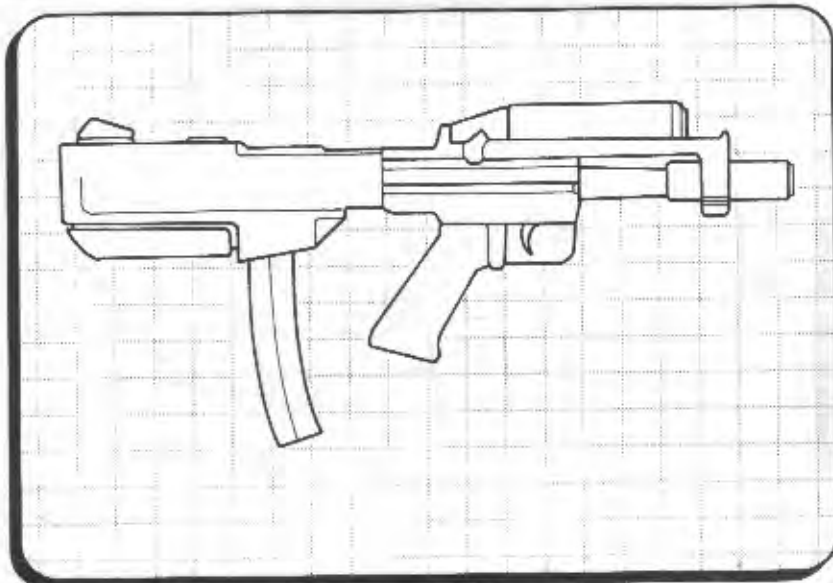

- Integral laser sight and sound suppressor!
- Largest ammo capacity of any SMG on the market!

The Beretta Model 70 holds the distinction, at 35 rounds, of having the greatest ammo capacity available in an SMG today! Combine that with an integral laser sight and sound suppressor, and you've got a weapon to arm the savage beast!

| | Type | Conceal | Mode | Ammo | Damage | Weight | Cost |
|------------------|------|---------|-------|--------|--------|--------|------|
| Beretta Model 70 | SMG | 3 | BF/FA | 35 (c) | 6M | 3.75 | 900¥ |

>>>>>[A friend of mine has the Model 70. He says it's so quiet that all you can hear is the metal-on-metal sound of the bolt action. Pretty wiz...]<<<<<<

—Lord Bunny <22:10:12/11-23-50>

ORDER HERE

| | | | |
|---|-------------|-----|------|
| ¥ | ☒ | 100 | PAID |
| ✈ | ✉ | 👤 | 🚚 |
| 🔧 | 📄 | 👤 | 📈 |
| 👤 | SALESPERSON | | |



ORDER HERE



SALESPERSON

SECTION

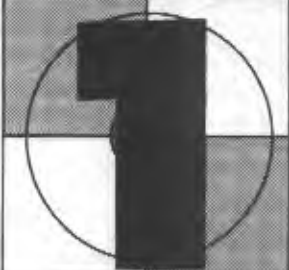

MP-5 TX

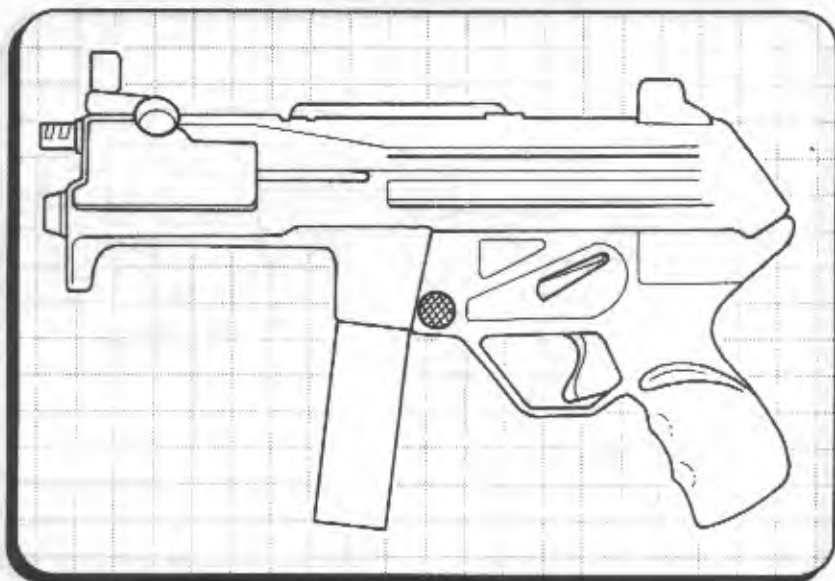

- H & K quality in a lighter, more compact weapon!
- Comes with integral laser sight and gas-vent recoil ports.

Adapting its H & K227 to a lighter round, Heckler & Koch has come up with another winner with the MP-5 TX. Voted favorite new weapon at the Paris Arms Show last year, the MP-5 TX is a sure winner by any standards.

| | Type | Conceal | Mode | Ammo | Damage | Weight | Cost |
|---------------------------|------|---------|----------|--------|--------|--------|------|
| Heckler & Koch MP-5 TX | SMG | 5 | SA/BF/FA | 20 (c) | 6M | 3.25 | 850¥ |

*Comes with Gas-Vent 2 Recoil Compensation.



INGRAM SMARTGUN

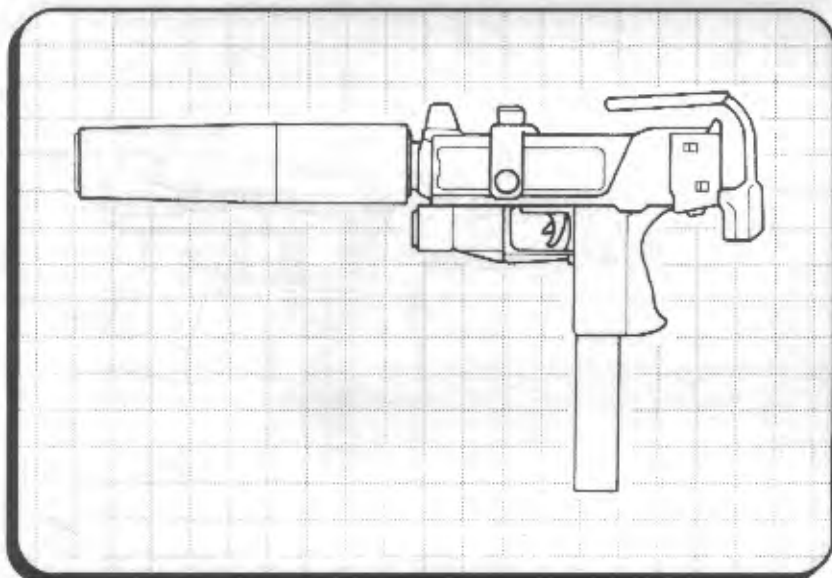

- Nicknamed "The Street Samurai's Sidekick"!
- Equipped with integral smartgun link and recoil suppression!
- Folding shoulder stock!

The May issue of *Street-Fighting Man* listed the Ingram Smartgun (Model 20t) as its readers' SMG of choice. One look and you'll see why more smart boys and girls carry the Ingram. Don't make the same mistake your enemy did. Carry the Model 20t.

| | Type | Conceal | Mode | Ammo | Damage | Weight | Cost |
|-----------------|------|---------|-------|--------|--------|--------|------|
| Ingram Smartgun | SMG | 5 | BF/FA | 32 (c) | 7M | 3.0 | 950¥ |

*Comes with Gas-Vent 2 Recoil Compensation.

>>>>["The Street Samurai Sidekick"???. Just who do they think they're selling to? If only 'real' Street Samurai bought them, they'd barely sell any at all.]<<<<<

—Finder-Man <06:34:04/12-19-50>

>>>>[Yes, but remember there are a lot of street punks who like to think that they're 'real Street Samurai'. They buy guns 100.]<<<<<

—FastJack <19:03:27/12-20-50>



ORDER HERE



SALESPERSON

SECTION

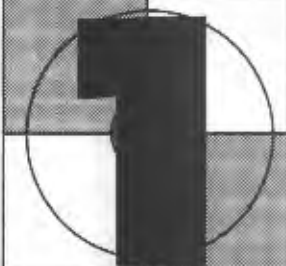

TMP SUBMACHINE GUN

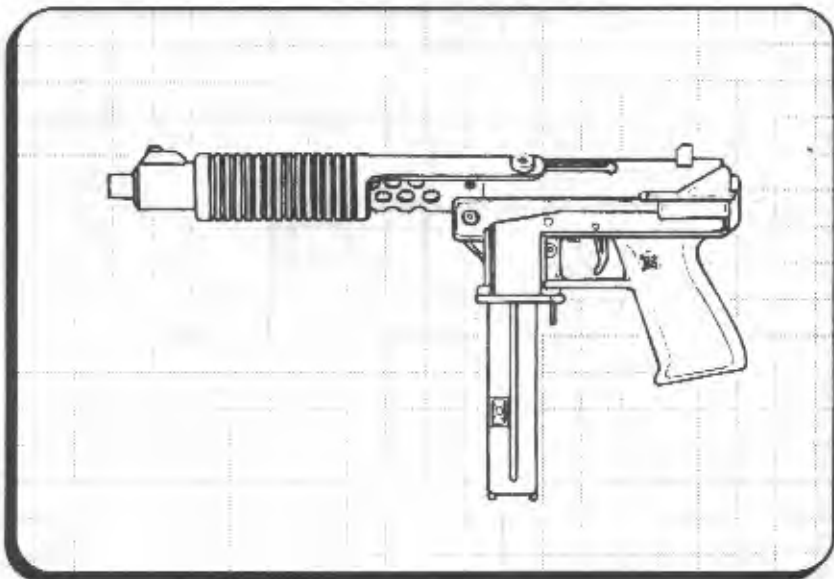

- Sandler breaks the price barrier!
- Integral laser sight and folding stock!

The Sandler Corporation stunned the market earlier this year with the introduction of this high-quality, low-cost submachine gun. Displaying craftsmanship normally only expected from the best weaponsmiths, the Sandler TMP is certified popular with the professional who demands the best.

| | Type | Conceal | Mode | Ammo | Damage | Weight | Cost |
|-------------|------|---------|-------|--------|--------|--------|------|
| Sandler TMP | SMG | 4 | BF/FA | 20 (c) | 6M | 3.25 | 500¥ |

*Folding Stock provides 1 point of Recoil Reduction.



>>>>[A former associate of mine had a TMP disintegrate in his hands at the most inopportune moment. Use with caution, or at least make sure the screws are tight.]<<<<<
 ---Hermes <09:32:19/12-17-50>

MODEL 100 SMG

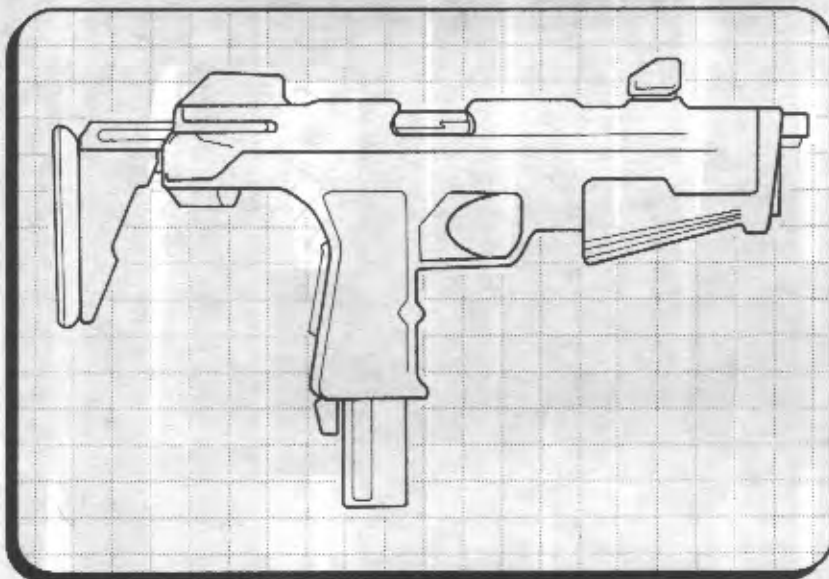

- The Japanese Security Forces weapon of choice!
- Comes with integral smartgun link!

Manufactured by Shin Chou Kogyo, Tokyo, the SCK Model 100 is used by more Japanese Security Forces worldwide than any other submachine gun. Rumor tells that even the elite Red Samurai pack this weapon! When it's time to pick the best, choose the one the best picked!

| | Type | Conceal | Mode | Ammo | Damage | Weight | Cost |
|---------------|------|---------|-------|--------|--------|--------|--------|
| SCK Model 100 | SMG | 4 | SA/BF | 30 (c) | 7M | 4.5 | 1,000¥ |



ORDER HERE

SALESPERSON

SECTION

1

ULTRASOUND SIGHT

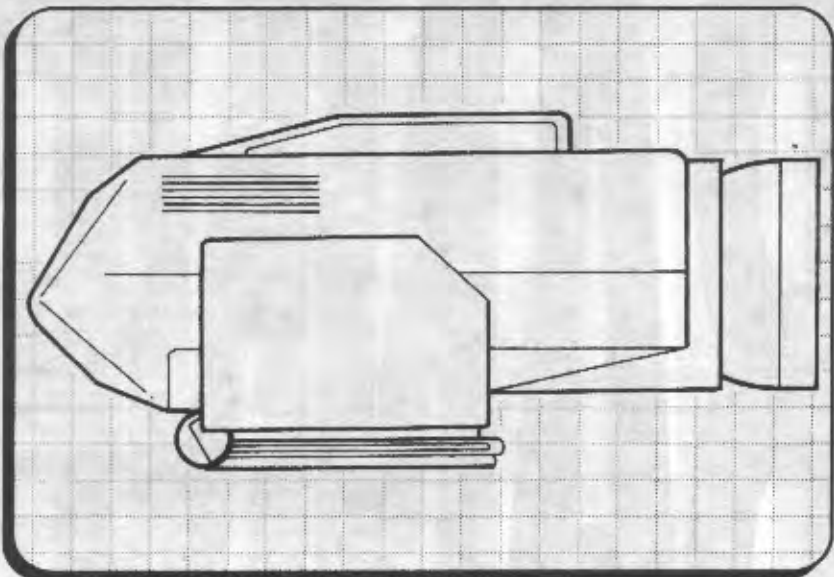

- Perfect for night fighting!
- Usable on all classes of firearms!

The Ares Ultrasound Sight is the latest technology in weapon accessories. Designed for night fighting, the Ultrasound Sight projects a scanning beam of coded sound that maps the area where a weapon is pointing. A topographic contour map of the target appears on a retinal display or special goggles. Usable in complete darkness and against foes who've managed a way around thermographic sights. Also reveals targets made invisible by magic! The coded sequencing prevents the ultrasound pulses from being easily traced back to your position. A mercenary must! Usable with all other targeting modification accessories.

| | Mount | Concealability | Rating | Effect | Weight | Cost |
|--------------------|-------|----------------|--------|--------|--------|--------|
| Ultrasound Sight | Top | -2 | — | * | +25 | 1,300¥ |
| Ultrasound Goggles | — | — | — | * | — | 1,100¥ |

*Halves visibility modifiers resulting from dim light, darkness, or invisibility.



RANGEFINDER ACCESSORY

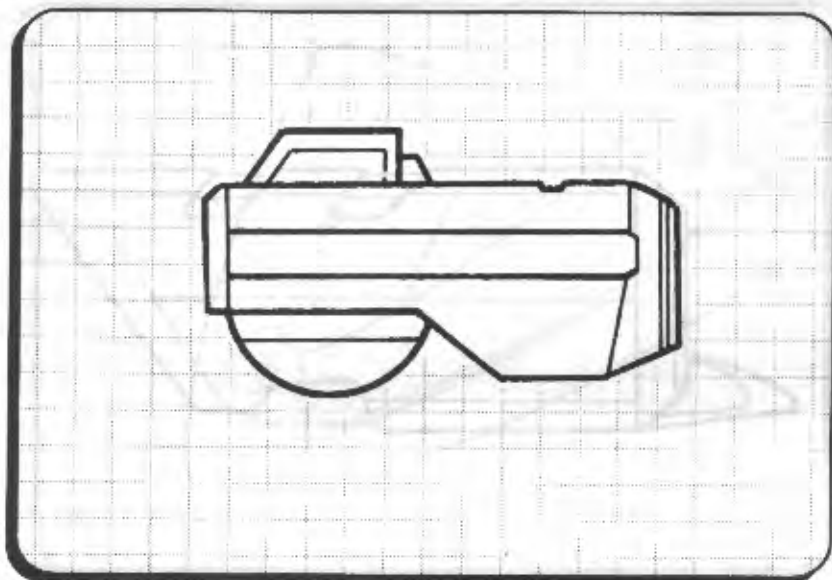

- Ends distance-to-opponent guessing!
- Vital for use with rifle-mounted grenade launchers!

The Ares Z2 Rangefinder is an underbarrel-mounted accessory that will feed range information through a smartgun link to a retinal display or smart-goggle display. In an instant, you can discover exactly how far away your opponent really is.

| | Mount | Concealability | Weight | Cost |
|-------------|-------|----------------|--------|------|
| Rangefinder | Under | — | .1 | 150¥ |

>>>>>[Doesn't sound like it would be much help, eh? Just wait until you get to the Security catalog...]<<<<<<
—FastJack <11:23:04/12-02-50>



ORDER HERE



SALESPERSON

SECTION

1



GAS VENT

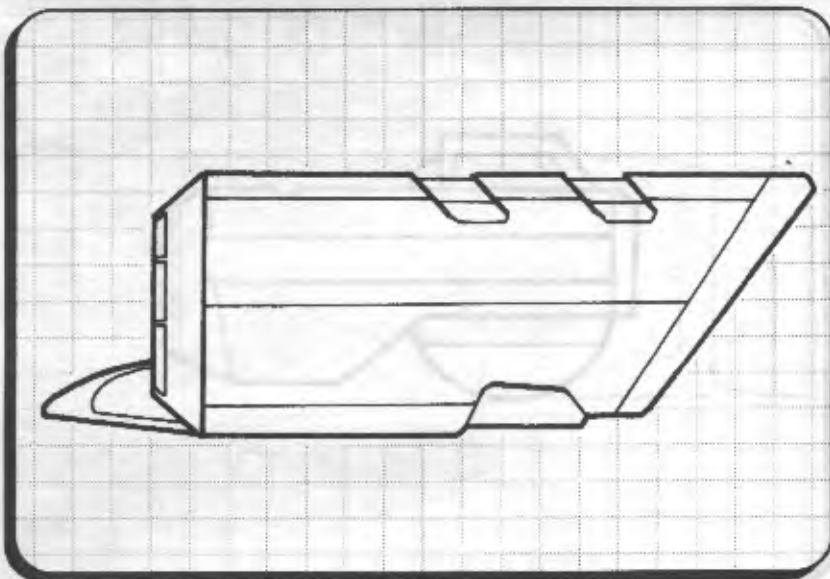

- Steady that aim with the new Lyco System!
- Usable with most firearm classes!

Lyco Systems of New Orleans has devised a new gas-vent recoil reduction system that is a great improvement over existing technology. Using a patented chamber system, the Lyco gas-vents are lighter, smaller, and more efficient than anything on the market today. Judge for yourself.

| | Mount | Concealability | Rating | Weight | Cost |
|----------------|--------|----------------|--------|--------|--------|
| Imp Gas-Vent 2 | Barrel | — | 2 | .25 | 550¥ |
| Imp Gas-Vent 3 | Barrel | -1 | 3 | .5 | 800¥ |
| Imp Gas-Vent 4 | Barrel | -2 | 4 | .75 | 1,000¥ |



FOREARM GUARDS

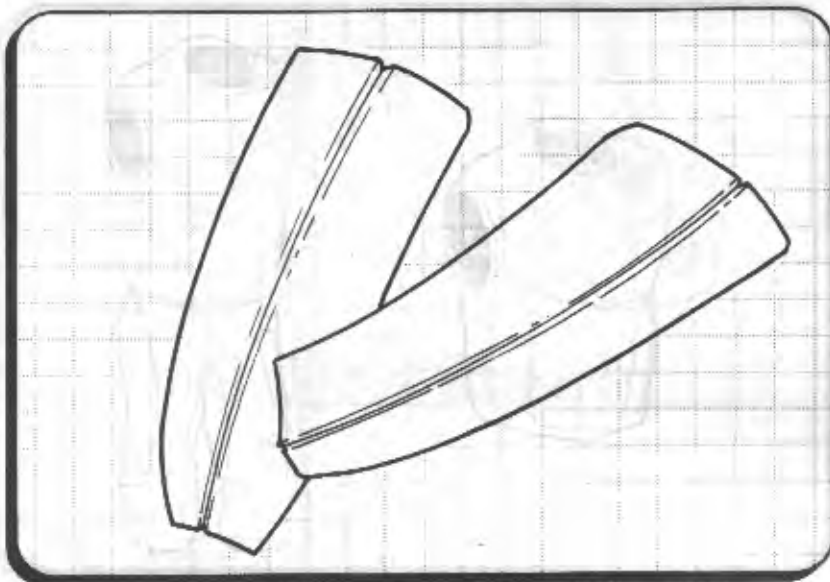

- The latest in defensive counterwear!
- Here because you demanded it!

After polling more than 1,000 hard-working people like you from around the country, Ares Arms has devised a new type of personal defense: forearm guards! Padded armorplast sections are form-fitted to each wearer, providing heavy impact protection across the back of each forearm. Designed specifically for parrying and forearm smashes! An instant street favorite!

| | Concealability | Rating | Damage | Weight | Cost |
|----------------|----------------|--------|------------|--------|------|
| Forearm Guards | 12 | +1* | (Str + 1)M | .2 | 250¥ |

*Gives the wearer an additional +1 of Impact Armor against unarmed and armed combat. Not good against ranged weapons of any kind.

ORDER HERE

| | | |
|---|-------------|------|
| ¥ | 100% | PAID |
| ✈ | ✉ | 📦 |
| 🔧 | 👤 | 📈 |
| 👥 | SALESPERSON | |



>>>>[Wonder how they polled the SINless?]<<<<<
 —FastJack <11:28:09/12-02-50>



ORDER HERE



SALESPERSON

SECTION

1



FORM-FITTING BODY ARMOR

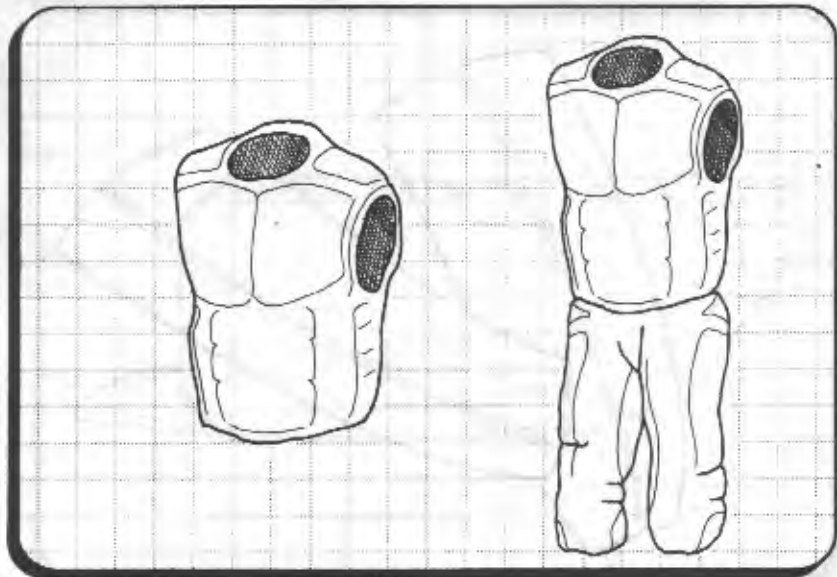

- Tailor-made protection!
- Undergarment protection designed for you!

Ares Arms has devised a new Form-Fitting Body Armor system that is contour-cut for each individual buyer. A patented design allows the various armor sections to be molded to your specific body size and shape. No more annoying gaps or folds to worry about. Available through local dealers, or by mail with measurements.

| | Concealability | Ballistic | Impact | Weight | Cost |
|-----------------------|----------------|-----------|--------|--------|------|
| Level 1 (Vest Only) | — | 2 | 0 | .75 | 150¥ |
| Level 2 (60% of Body) | 15 | 3 | 1 | 1.25 | 250¥ |
| Level 3 (90% of Body) | 12 | 4 | 1 | 1.75 | 500¥ |

*Not usable with any other form of Body Armor.



>>>>>[Oooooo! "Underwear that's fun (and safe) to wear!"]<<<<<<
 —Stinger-Six <18:23:19/12-15-50>

SECURETECH CLOTHING

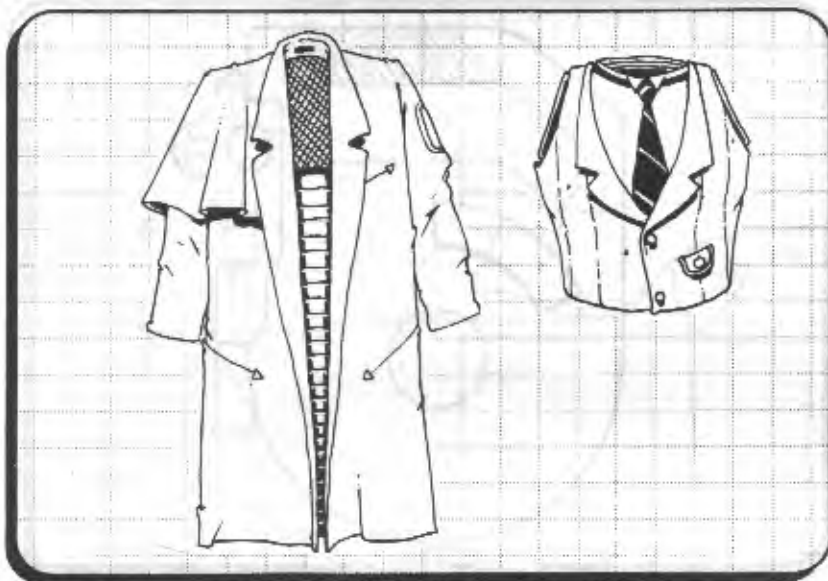

- The latest in protective body armor!
- Many styles to choose from!

Kelmar Technologies has cornered the market with their stylish line of protective clothing, and we are the first supplier in North America to provide you with the full line. Available in a full range of designer colors and styles. The technical specifications listed below are correct, unlike a certain other rival publication's. <Shadow Gear, Summer 2050 :: FJ>

| | Concealability | Ballistic | Impact | Weight | Cost |
|-------------------|----------------|-----------|--------|--------|------|
| Secure Clothing | 12 | 3 | 0 | 1.5 | 450¥ |
| Secure Jacket | 9 | 5 | 3 | 3 | 850¥ |
| Secure Vest | 15 | 2 | 1 | .75 | 175¥ |
| Secure Ultra-Vest | 14 | 3 | 2 | 2.5 | 350¥ |
| Secure Long Coat | 10 | 4 | 2 | 2.0 | 650¥ |

The Lined Coat adds 50 percent to the concealability rating of any weapon with a rating of 4 or higher.



ORDER HERE



SALESPERSON

SECTION



STEALTH GRAPPLE LINE

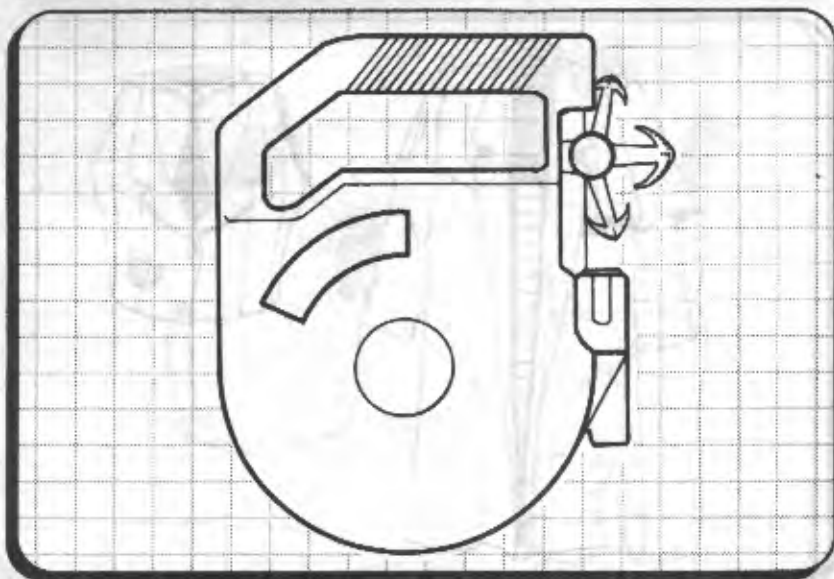

- 1,000 kilogram test weight!
- Leave nothing behind!

This revolutionary Grapple Line acts like a normal line until you're done with it. Once the job is complete, simply touch the line with the appropriate reaction-catalyst stick and watch as the line becomes unstable and crumbles to dust in front of you! Takes only seconds, and those incriminating dangling lines are gone forever! Stimulant stick is usable forever.

| | Weight | Cost |
|----------------|------------------|--------------------|
| Stealth Line | 3 per 100 meters | 85¥ per 100 meters |
| Catalyst Stick | - | 120¥ |
| Normal Line | 2 per 100 meters | 50¥ per 100 meters |



GRAPPLE GUN

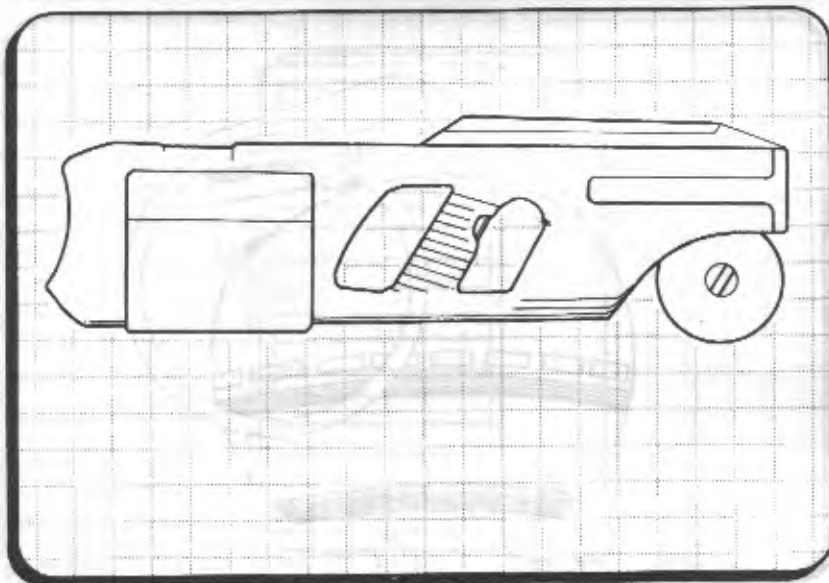

- Fires grapple hooks over 300 meters!
- Quiet and safe!

The Conner Grapple Gun is the latest in grapple-propellant systems and is guaranteed to shoot the patented Wagner Grapple over 300 meters straight up! The grapple gun comes with its own internal spool, or external feed, for using the grapple line of your choice. Wagner rappelling gear fits snugly into the stock.

| | Concealability | Weight | Cost |
|-----------------|----------------|--------|------|
| Grapple Gun | 7 | 2.25 | 450¥ |
| Rappelling Gear | — | 5 | 250¥ |

*Use the Heavy Crossbow Range Table, Str = 5

ORDER HERE

| | | | |
|----|-------------|---|------|
| ¥ | ☞ | 📄 | PAID |
| ✈️ | ✉️ | 📧 | 🚚 |
| 🔧 | 🏠 | 👤 | 📈 |
| 👥 | SALESPERSON | | |



ORDER HERE



SALESPERSON

SECTION

1



AFR-7 FLASH GRENADE

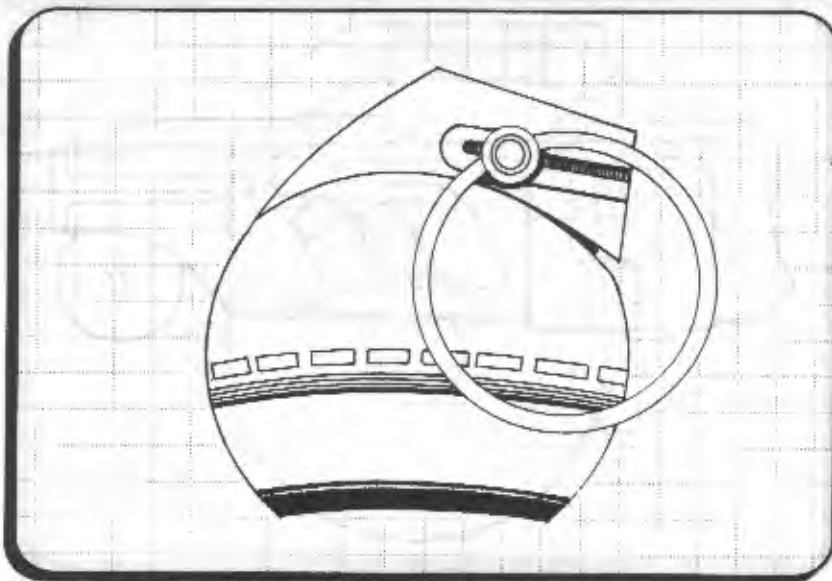

•Higher candle-power than ever before!

The AFR-7 is the most powerful flash grenade on the market. Weighing the same as a conventional grenade, it produces a blinding flash of light effective to 30 meters. Guaranteed ignition and improved burn characteristics make the AFR-7 the flash grenade of choice.

| | Concealability | Damage | Effect | Weight | Cost |
|---------------|----------------|--------|--------|--------|------|
| Flash Grenade | 6 | 5L* | 30m** | 2.5 | 40¥ |

*Grenade has a blast-zone of 1 meter, inflicting damage of 5L within that area.

**Flash is effective out to 30 meters. Base target modification for all those looking in direction of grenade is +6. Target modifier is reduced by 1 for every 5 meters distance from the point of ignition. Flare Compensation reduces the target modifier by 50 percent (round down). Effect lasts for 5 combat turns. Time can be reduced with a Body (5) Test where every 2 successes reduces the time by 1 Combat Turn.



FLASH-PAK

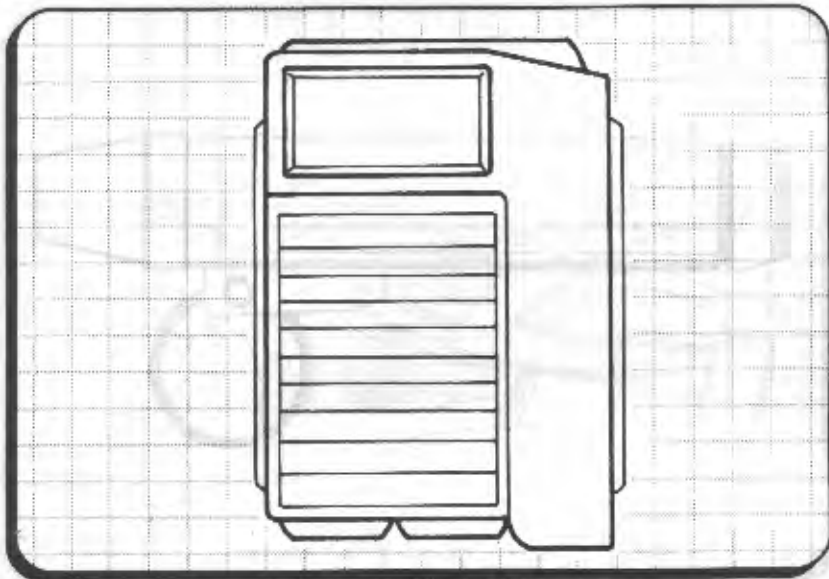

- Distract and blind your opposition!
- Small, compact, reusable!

Another recently released winner from Winter Systems of Manhattan. The size of a cigarette pack, this small device contains four quartz-halogen micro-flashes designed to fire in random sequence to create a series of searing flashes that disorient, distract, and possibly even blind anyone looking in their direction! Works even against cybereyes with flare compensation!

| | Concealability | Rating | Weight | Cost |
|------------|----------------|--------|--------|------|
| Flash-Pak* | 12 | +4 | .2 | 250¥ |

*Use of a flash-pak gives opponents facing the flash-pak a +4 target modifier to all ranged attacks. Opponents with flare-compensation receive only a +2. Target modification is reduced by 1 for every 5 meters from the Flash-Pak. The Pak also negates effects of poor or no lighting for the duration of its use, but does impose its own +2 because of its stroboscopic nature.

>>>>[Why do I read this and hear the words of a very old song... something about being blinded by the light, and then running in the night?]<<<<<

—Steel Lynx <13:55:35/12-20-50>



ORDER HERE

PAID

SALESPERSON

SECTION

1

RES

MICRO FLARE

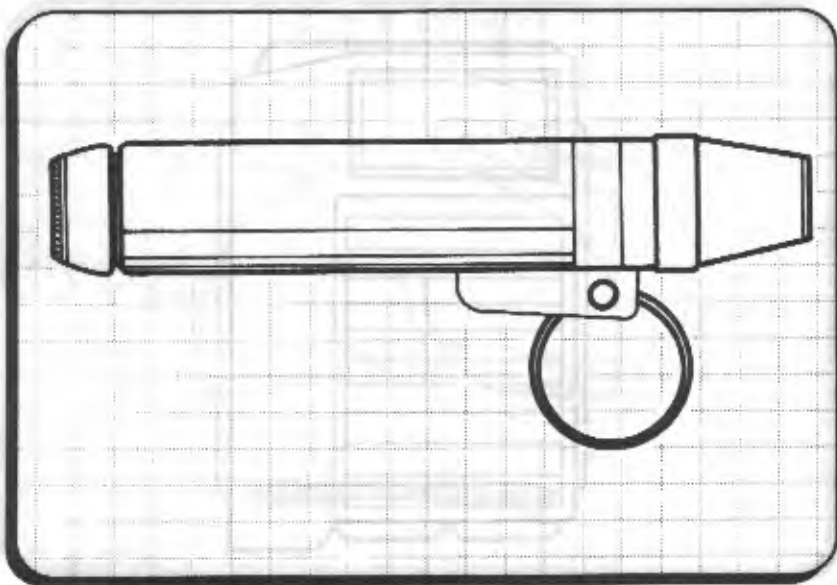

- A penlight-sized flare launcher!
- Perfect for those sudden emergencies!

Winter Systems of Manhattan has finally released one of its patented mini-system security devices to the general public, the Micro Flare. A little larger than a penlight, the Micro Flare packs a full-size warning/hazard flare. Capable of reaching altitudes in excess of 200 meters, the flare is available in white, red, or green. Reloadable, it makes the perfect emergency signalling device.

| | Concealability | Rating | Weight | Cost |
|-----------------------|----------------|--------|--------|------|
| Micro Flare Launcher* | 3 | 2 | 2 | 50¥ |
| Flare | — | 2 | — | 75¥ |

*If fired as a weapon, use the Bow Range Table, plus an additional +2 target modifier at all ranges beyond Short. The weapon will inflict 4M damage, and ignite flammables. The Rating indicates that the flare will negate a +2 target modifier due to low or poor light. The flare will illuminate an area equal to one square city block.



AURORA RACING BIKE

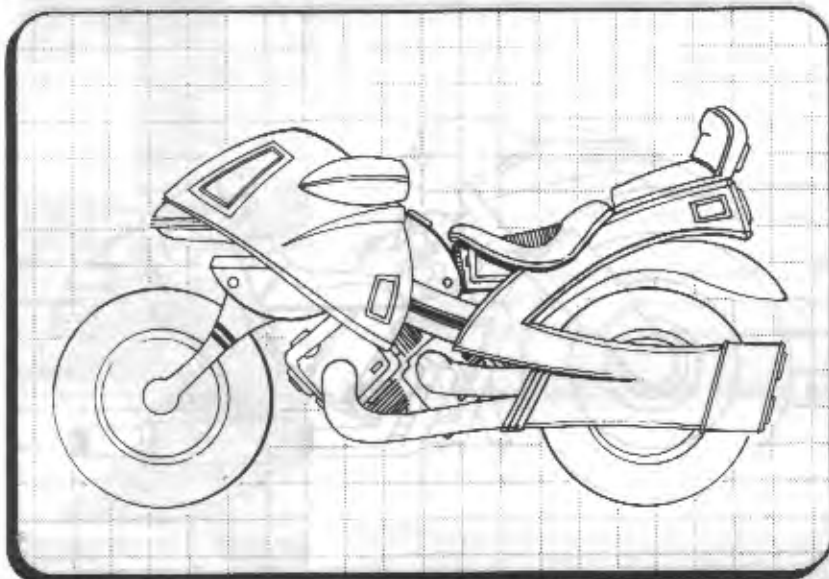

- Low and sleek, the Aurora is the fastest bike on the streets!
- Maximum power and style!

The Aurora, new from Suzuki Transport, is guaranteed to wipe the smile off the face of any cocky Yamaha Rapier jockey. Designed for speed, the Aurora features advanced ride-stabilization equipment for superb handling and control. Buy today and we'll throw in a custom paint job so those Rapiers will know exactly who blew them away.

| | Handling | Speed | Body | Armor | Signature | Pilot | Cost |
|---------------|----------|--------|------|-------|-----------|-------|---------|
| Suzuki Aurora | 2 | 70/210 | 1 | 0 | 4 | 1 | 15,000¥ |

(The Aurora, like the Rapier, is unable to accept either a firmpoint or hardpoint. The Harley Scorpion is able to accept up to 2 firmpoints or 1 hardpoint. A firmpoint costs 10 percent of the vehicle cost and a hardpoint 30 percent.)

ORDER HERE

| | | | |
|----|-------------|------|------|
| ¥ | 📄 | 100% | PAID |
| ✈️ | ✉️ | 👤 | 🛒 |
| 🔧 | 🏠 | 👤 | 📈 |
| 👤 | SALESPERSON | | |



ORDER HERE



SECTION



VIKING HEAVY MOTORCYCLE

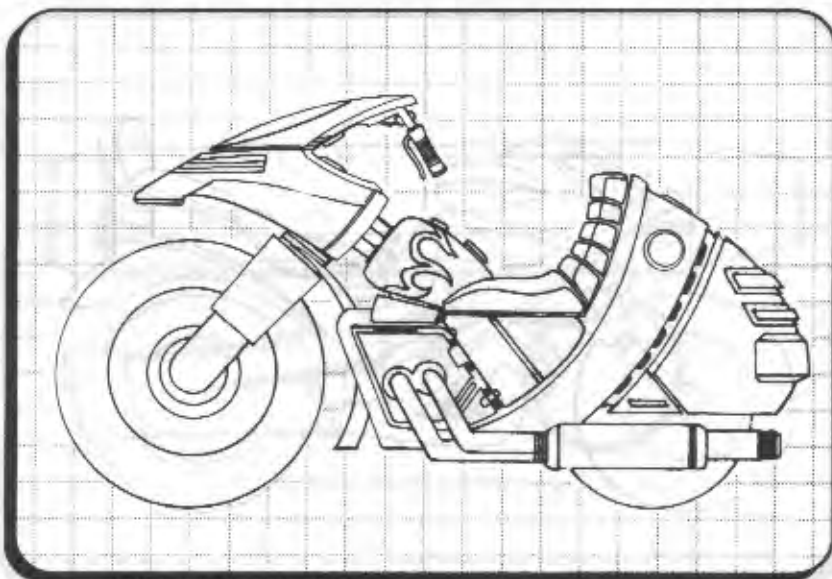

- A full-size bike for the real kings of the road.
- Improved, high-impact structure bracing.

Honda Motors takes on the giant Harley-American full-size bike market with their powerful Viking. Feel the weight beneath you and the power at your fingertips. The Honda Viking brings you power, performance, and prestige all in one stylish package.

| | Handling | Speed | Body | Armor | Signature | Pilot | Cost |
|--------------|----------|--------|------|-------|-----------|-------|---------|
| Honda Viking | 3 | 50/160 | 4 | 1 | 3 | 2 | 17,000¥ |

(The Viking is able to accept 2 firmpoints at 1,700¥ per firmpoint, or 1 hardpoint at 5,100¥.)



ARES CATALOG WINTER 2050

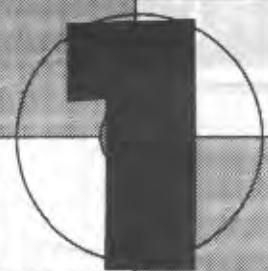

ARES SECURITY



WIREMASTERS



ACCESSORIES



ARES SECURITY CATALOG 2050

You demand the best, and that's why you've chosen Ares America for over 25 years. Performance and reliability are what make Ares weapons and accessories the perfect choice for your security needs.

Within these pages, you will find the best security and law-enforcement equipment from manufacturers world-wide. Each item has been rigorously tested in the Ares laboratories and has met or exceeded our requirements for durability and dependability.

If you see it in these pages, you can count on it.

Contact your local Ares America sales representative, or call us directly at NA/UCAS-MW/BULLETS. We'll be expecting you.

—Nathaniel Naidich, Director of Sales, Ares America

Ares America is a division of Ares Arms, a wholly owned subsidiary of Ares Macrotechnology Incorporated, Detroit, Michigan, UCAS.

>>>>>[For those who don't know, the Ares America Security Catalog is difficult to obtain. When asked, the Ares sales and public relations departments will deny its existence. It's available only to licensed law enforcement, military, and security organizations with a valid, current credit rating. Don't ask me what they're trying to hide, but...feel free to post and comment as you like.]<<<<<<
—FastJack <14:39:02/10-07-50>

>>>>>[One of you out there downloaded this file from the data net just after I posted it and attempted to sell it off to Ares' major competitor. You know who you are, and your deck is mine for the taking. Think about that the next time you're in some cold, dark corner of the Matrix.]<<<<<<
—FastJack <23:43:43/10-07-50>

ORDER HERE



SALESPERSON

SECTION



M22A2 ASSAULT RIFLE

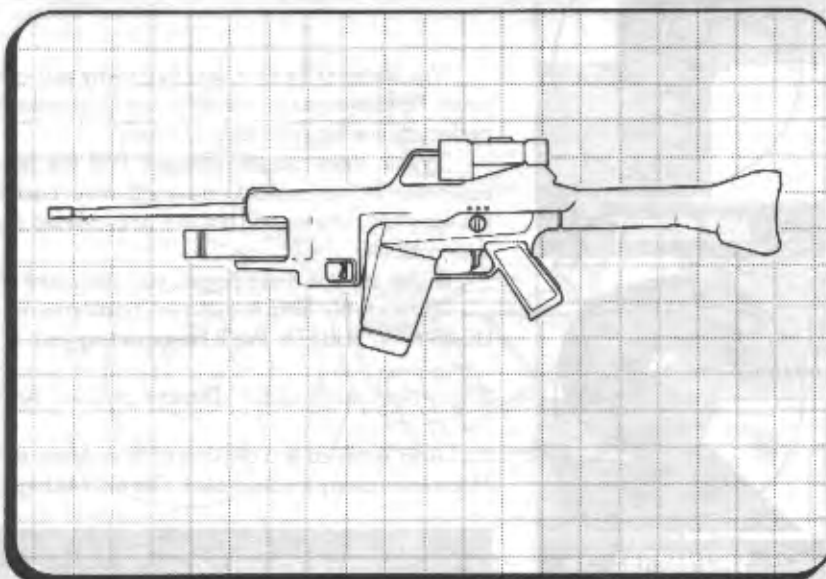

•Contender in the current UCAS Squad Rifle Trials!

The Colt M22A2 is a quality weapon at an astoundingly affordable price. Accepting a 40-shot clip, the weapon also comes with an integral grenade launcher, Gas-Vent 1 recoil reduction, and a built-in Mag-2 imaging sight. Voted Best New Weapon of 2048 by International Mercenaries Guild.

| | Type | Conceal | Mode | Ammo | Damage | Weight | Cost |
|------------|---------|---------|----------|--------|--------|--------|--------|
| Colt M22A2 | Assault | 3 | SA/BF/FA | 40 (c) | 8M | 4.75 | 1,600¥ |



G12A3Z

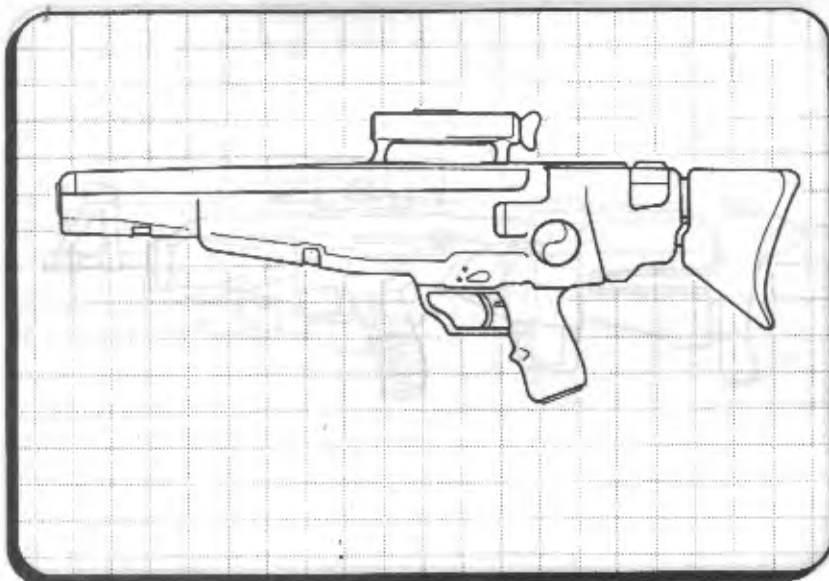

•Contender in the current UCAS Squad Rifle Trials!

The H&K G12A3z is the next logical step from the H&K G11A4z, the premier assault rifle of the last two generations. Improving on the best characteristics of the reliable G11, the G12 is lighter, less bulky, and equipped with an integral laser sight, Gas-Vent 2 recoil reduction system, and telescoping shoulder-stock for an additional level of recoil reduction. Additionally, the G12 can carry an under-barrel grenade launcher at only a fraction of the concealability loss.

| | Type | Conceal | Mode | Ammo | Damage | Weight | Cost |
|--------|---------|---------|----------|--------|--------|--------|--------|
| G12A3z | Assault | 2 | SA/BF/FA | 32 (c) | 8M | 5.25 | 2,200¥ |

>>>>[Hey, Ma, I coulda been a contender!]<<<<<
—Zapper Weisman <11:15:49/12-21-50>
>>>>[Just who is this guy???]<<<<<
—Metallic Marauder <23:15:06/12-29-50>



ORDER HERE



SALESPERSON

SECTION



VZ 88 V ASSAULT RIFLE

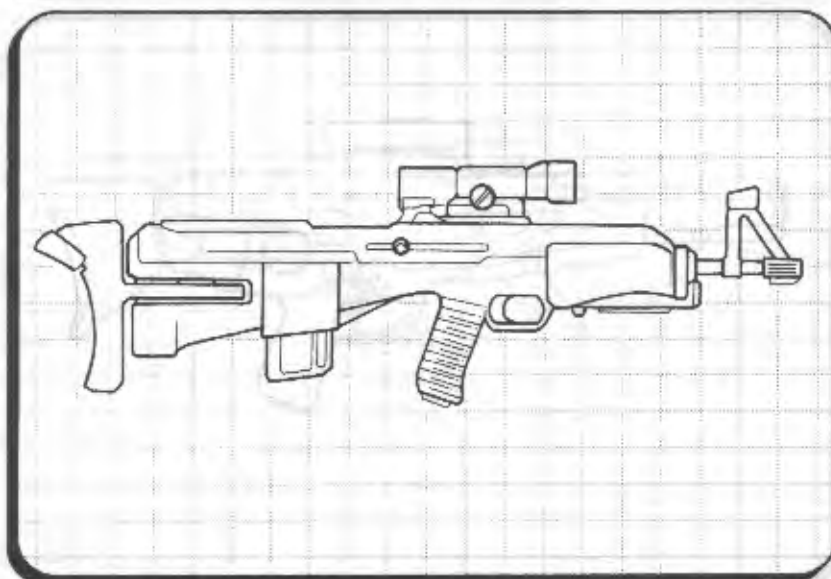

• Assault Rifle of the Czech Mechanized Forces!

The vz 88V, manufactured in Czechoslovakia, is a premium-grade assault rifle equipped with many of the accessories normally found only in weapons of Western manufacture. Mounting an integral laser and Mag-2 imaging scope, the vz 88V also comes with Gas-Vent 2 recoil reduction and a folding metal shoulder stock for an additional level of recoil reduction.

| | Type | Conceal | Mode | Ammo | Damage | Weight | Cost |
|--------|---------|---------|----------|--------|--------|--------|--------|
| vz 88V | Assault | 2 | SA/BF/FA | 35 (c) | 8M | 5.5 | 1,800¥ |



AUG-CSL WEAPON SYSTEM

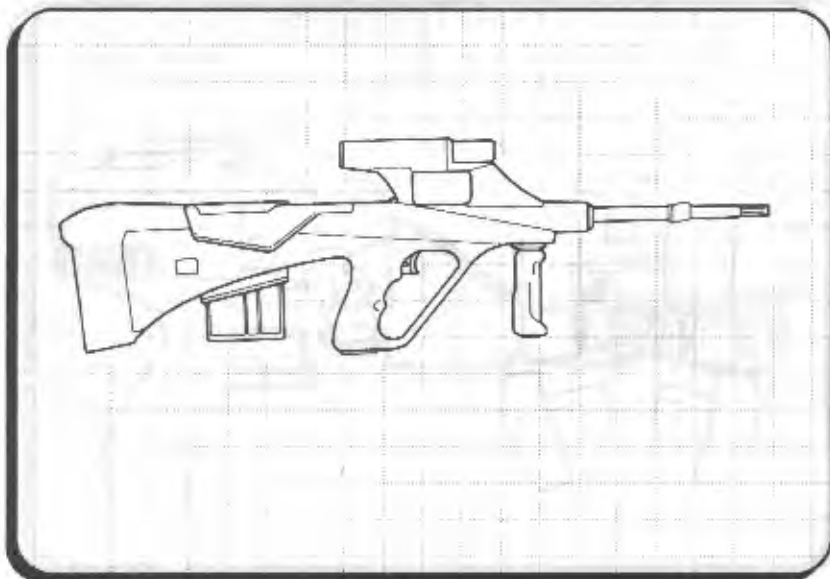

•The assault rifle of the Confederated American States!

The AUG-CSL is a multi-weapon, capable of being reassembled, variously, as a submachine gun, a carbine, an assault rifle, or a heavy-barreled automatic rifle for use as a light machine gun. Conversion takes just under one minute, and all the parts can fit into a large briefcase. All models have an integral laser sight in the carrying handle and can fit a smartgun adapter at no loss of concealability.

| | Type | Conceal | Mode | Ammo | Damage | Weight | Cost |
|---------------|----------|---------|----------|--------|--------|--------|------|
| Steyr SMG | SMG | 4 | SA/BF | 40 (c) | 6M | 3.5 | * |
| Carbine | Sporting | 3 | SA/BF | 40 (c) | 7S | 3.75 | * |
| Assault Rifle | Assault | 2 | SA/BF/FA | 40 (c) | 8M | 4 | * |
| Light MG | Light MG | NA | SA/BF/FA | 40 (c) | 8M | 5.5 | * |

*The entire Steyr AUG-CSL package with all listed accessories costs 4,500¥. The weapon also comes with Gas-Vent 1 recoil reduction.

>>>>>[When this first came out, my buddy Wedge was in heaven. He rushed right out, scooped one up, and proceeded to play. Everything was great, and Wedge had even contacted Steyr about some design improvements. One day, he got a little confused and mounted the Light MG barrel with the carbine folding-stock, and, well, broke his shoulder. Steyr plans a color-code system for parts, and Wedge says he likes his new shoulder better anyway.]<<<<<<
—FastJack <16:21:43/12-21-50>

ORDER HERE

SALESPERSON



ORDER HERE

SALESPERSON



MP LASER

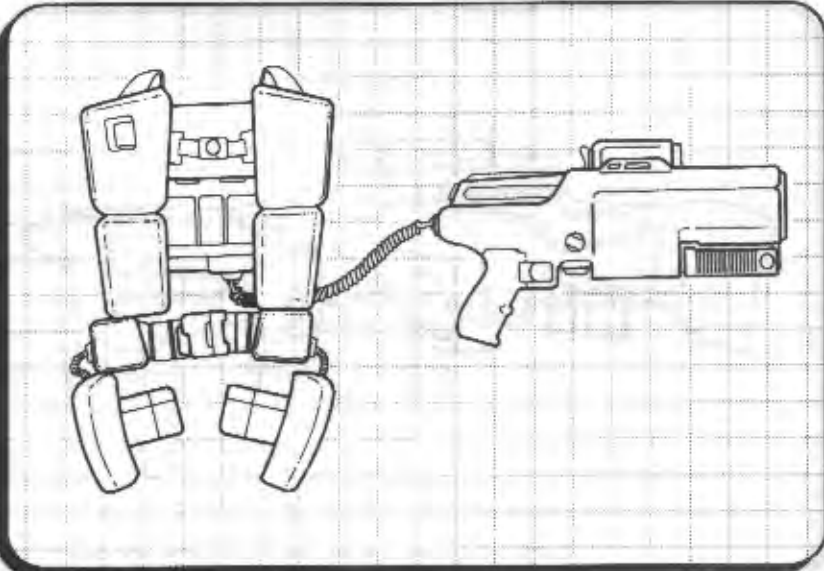

•Finally, an efficient portable laser system!

Ares Arms is proud to announce the first portable laser system with the ability to deliver enough joules of energy to make a difference. Built from seven different Ares patents, the MP Laser is the future of security and law-enforcement weaponry. Designed to be fielded by a single carrier, unlike inefficient two-man team weapons, the MP Laser is a self-contained system capable of handling high-threat situations. Powerful enough to affect even armored vehicles, the MP Laser is a multi-purpose weapon perfectly suited for the variety of volatile and unpredictable situations that the modern professional confronts. The MP Laser is powered by six high-performance, peak-discharge soft batteries mounted along each thigh. These batteries, as a unit, are good for 20 pulses of energy. The entire power system is designed for easy replacement, and each battery package can be recharged for later use. Meet the future head-on; arm up with Ares and the MP Laser system.

| | Conceal | Mode | Shots | Damage | Weight | Cost |
|----------|---------|------|-------|--------|--------|------------|
| MP Laser | NA | SA | 20* | 15M | 30 | 2,500,000¥ |

*Per battery package.

Use the Sniper Rifle Range Table for determining Range Steps. Decrease the Power Level of the weapon by 2 for each Step beyond Short (Medium -2, Long -4, Extreme -6). Ballistic Armor has no effect against the MP Laser, and Armor Impact is only one-half (round down) effective. There is no recoil penalty.

MP LASER

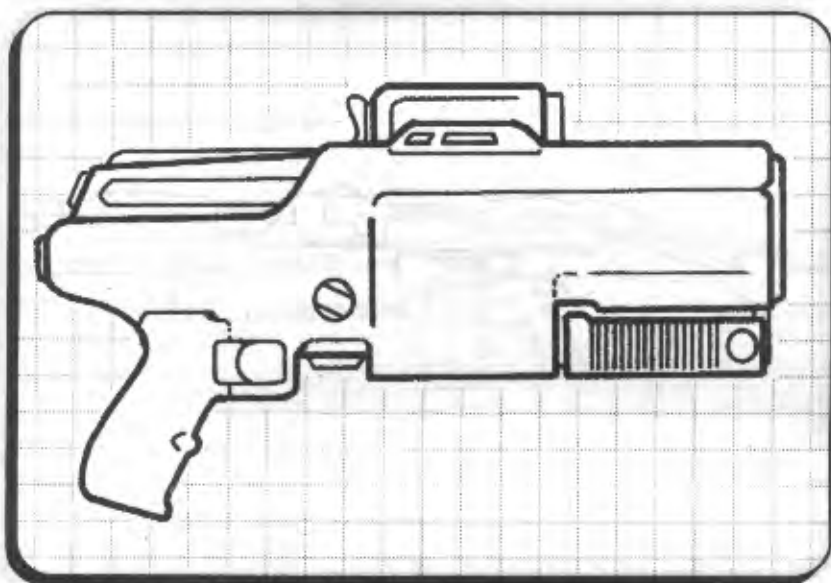

>>>>>[Can you believe this? This isn't a security or law-enforcement weapon; it's a military weapon. What the hell is it doing in a "security" catalog? Can we expect next year's catalog to include Seven-7 nerve gas, high-explosive, multiple high-velocity fragmenting claymore-style mines, and low-yield sub-tactical nukes? Let's get some chip-truth here, chummers. Has Ares lost it, or are they callously displaying the same blatant disregard for the "have-nots" as virtually every other security agency in existence? I have always considered Knight Errant to be one of the more respectable security/enforcement agencies, but after reading this document, I see I must have been horribly mistaken.]<<<<<<

—The Neon Samurai <01:17:24/12-09-50>

>>>>>[Hey, Neon, lighten up, will ya? Har-har!]<<<<<<

—Findler-Man <12:32:20/12-13-50>

>>>>>[I understand Winter Systems in Manhattan is working on a portable continuous laser that might reach production within a year. Allegedly, the prototype is able to maintain its beam for up to three minutes at a time and project up to 60 meters.]<<<<<<

—Hatchetman <21:45:03/12-17-50>

>>>>>[Don't believe anything, rather everything, you read.]<<<<<<

—Nightfire <04:05:48/12-18-50>



ORDER HERE



SALESPERSON

SECTION



ARES MP LMG

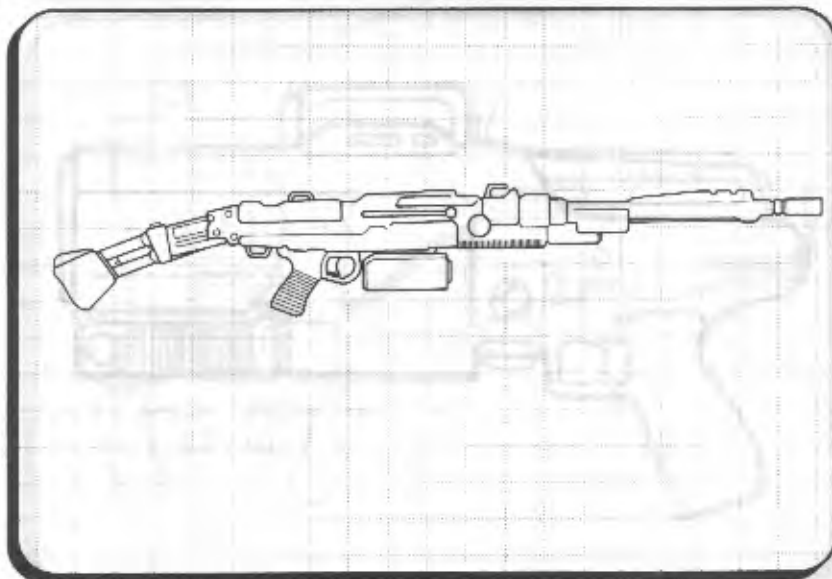

•The most popular light machine gun in the world.

The Ares MP is the weapon of choice of more military and paramilitary organizations around the world than any other light machine gun. Capable of sustained automatic fire for hours on end, the Ares MP comes equipped with an integral laser sight, a Gas-Vent 2 recoil-compensation system, and a hip-pad bracing system. The weapon accepts either a 100-round belt or a 50-round clip.

| | Type | Conceal | Mode | Ammo | Damage | Weight | Cost |
|---------|----------|---------|-------|--------|--------|--------|--------|
| Ares MP | Light MG | NA | BF/FA | 50 (c) | 7S | 7.5 | 2,200¥ |



>>>>[Heh.]<<<<<
—Findler-Man <11:19:49/11-30-50>

FN-MAG 5

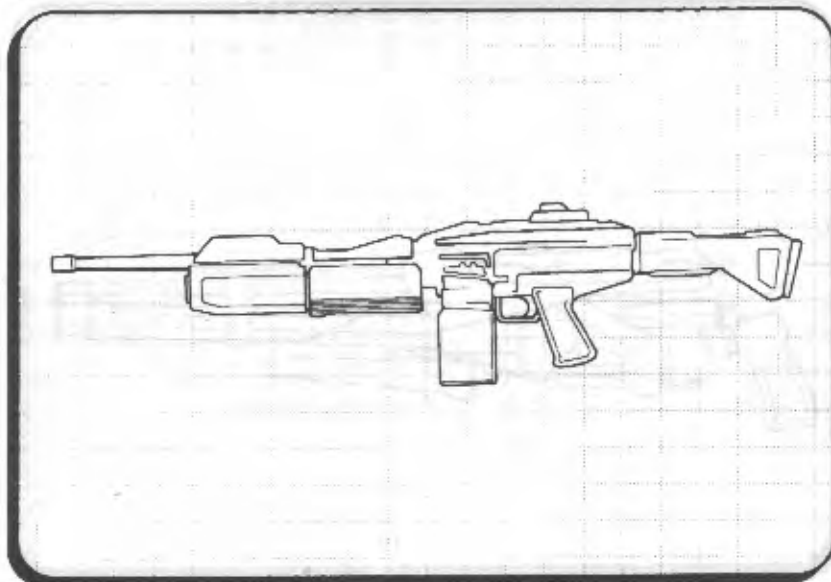

•Proven Fabrique National craftsmanship for the demanding military and security professional!

More military and security agencies world-wide choose the FN-MAG 5 medium machine gun as their light vehicle weapon or general purpose machine gun. The weapon can accept an external 50-round box or a belt. It comes with an integral gas-vent 2 recoil-reduction system and laser sight.

| | Type | Conceal | Mode | Ammo | Damage | Weight | Cost |
|----------|-----------|---------|------|----------------|--------|--------|--------|
| FN-MAG 5 | Medium MG | NA | FA | Belt, 50 (Box) | 95 | 9.5 | 3,200¥ |

ORDER HERE

| | |
|---|-------------|
| ¥ | PAID |
| ✈ | ✉ |
| 🔧 | 👤 |
| 👥 | SALESPERSON |



ORDER HERE

SALESPERSON

SECTION

RES

VINDICATOR MINIGUN

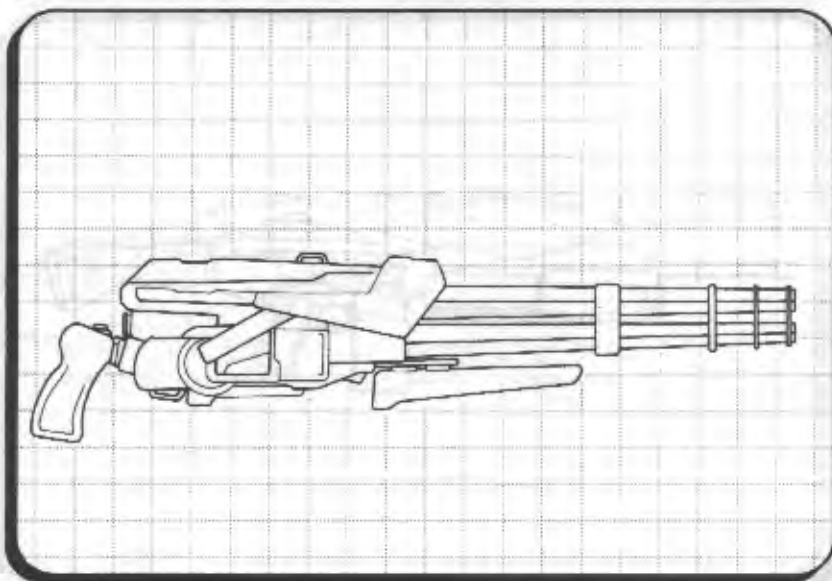

•Electric driven, multiple rotating-barrel firepower!

Based on the popular GE M134 hardpoint minigun design, the Vindicator is a portable weapon of astounding firepower. High-density batteries provide the power needed to spin the six rotating barrels, allowing the weapon to fire at an incredible rate. The rotating-barrel design prevents barrel-warping due to excess heat, and the isolated ammo feed reduces the dangers of cook-offs, misfires, and misfeeds. Not for the weak-kneed.

| | Type | Conceal | Mode | Ammo | Damage | Weight | Cost |
|------------|----------|---------|------|----------------|--------|--------|---------|
| Vindicator | Light MG | NA | FA | Belt 50 (c) | 7S | 15 | 12,500¥ |

*This weapon has a permanent rate of fire of 15 rounds per Complex Action. This rate cannot be adjusted. Use the heavy weapon recoil rules (SR11, p. 85)



>>>>[Be warned. I recently had the opportunity to see this weapon in use during a run. Once the rotating barrels are activated, you've only got about ten minutes of fire time before the batteries geek. It also takes a few seconds {1 turn} for the barrels to get up to speed. Once they're there, however, it's major hosing time. Rock and Roll!]<<<<<

—FastJack <04:23:19/11-23-50>

>>>>[Believe me, the electric whir of a Vindicator is extremely distinctive. Even more distinctive is the sound of it in use. It's not something you easily forget.]<<<<<

—The Neon Samurai <23:43:05/12-08-50>

SURFACE-TO-AIR MISSILE

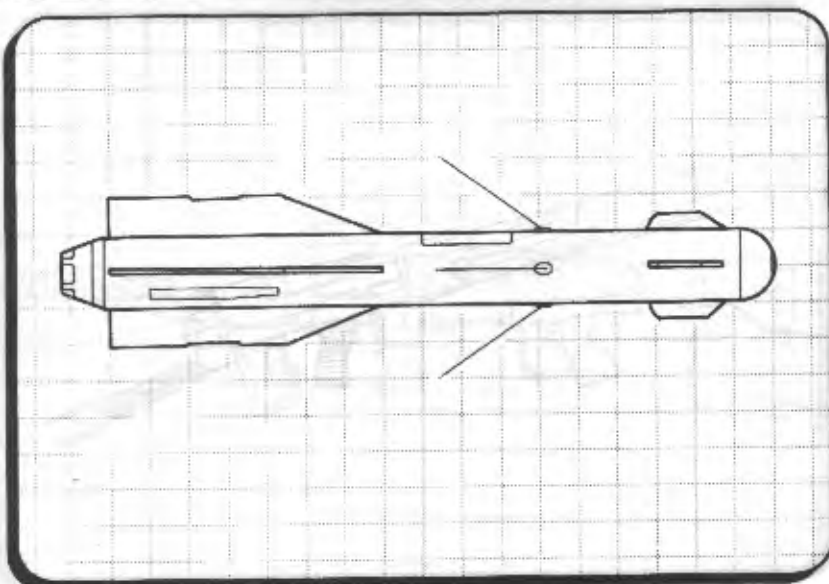

•Extended range for distant targets!

Designed for engaging long-distance aerial targets, this man-pack SAM is engineered for maximum velocity and anti-airframe impact. Compatible with any man-pack missile launcher, the SAM has a sophisticated on-board target acquisition and tracking seeker-head that has proven itself even against low, dodging targets.

| | Intelligence | Damage | Weight | Cost |
|--------|--------------|--------|--------|--------|
| LR SAM | 4 | 13D | 1.5 | 2,200¥ |

*Use the normal Missile Launcher Range Chart, but extend extreme range out to 5,000 meters.



>>>>>[I'll bet the Lone Star Wasp and Yellojacket flyers just love this
joker.]<<<<<<
—Stinger-Six <18:22:23/01-12-51>



ORDER HERE



SECTION



PANTHER CANNON

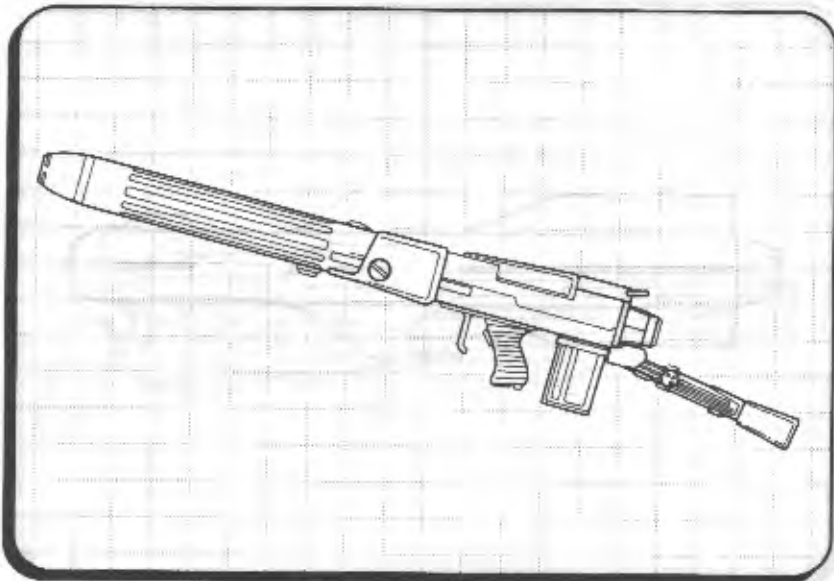

•Battle-proven maximum firepower!

The Panther Assault Cannon, designed and produced by Panther Industries, is your only choice for heavy assault weapon. Firing a stable superplast explosive warhead, the Panther has proven effective against both hard and soft targets. Comes with shoulder-strap and hip-bracing gear for stable fire.

| | Type | Conceal | Mode | Ammo | Damage | Weight | Cost |
|---------|--------|---------|------|----------------|--------|--------|--------|
| Panther | Cannon | NA | SS | 22 (c) Belt | 18D | 18 | 7,200¥ |



>>>>[Grade A bang-bang!]<<<<<
—Hatchetman <23:17:54/12-17-50>

M107 GPHMG

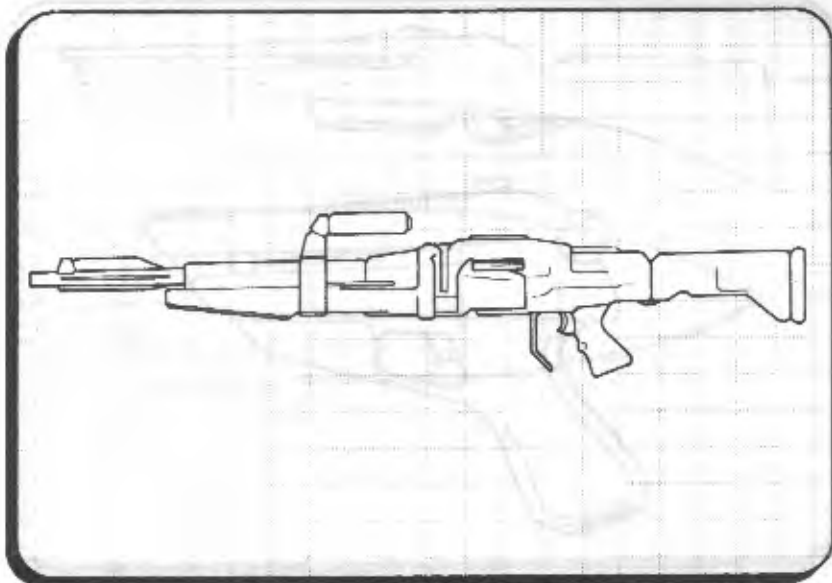

•Chosen by the UCAS Armed Forces!

From Stoner-Ares Weapon Systems of Detroit, Michigan, comes the latest in the long line of Stoner-Ares weapon systems, the M107 GPHMG (General Purpose Heavy Machine Gun). Based on the previous Stoner-Ares heavy design, the battle-proven M98tz, the M107 features many of the same advantages of its older brother, merged with the technological improvements of the last decade. Capable of taking ammunition from either a 40-round internal clip or an external disintegrating belt, the M107 comes with a gas-vent 3 recoil-reduction system and an integral laser sight.

| | Type | Conceal | Mode | Ammo | Damage | Weight | Cost |
|------|----------|---------|------|----------------|--------|--------|--------|
| M107 | Heavy MG | NA | FA | Belt, 50 (Box) | 105 | 12.5 | 5,200¥ |

>>>>>[General Purpose Heavy Machine Gun? And to think I always believed the purpose of heavy machine guns was pretty well defined.]<<<<<

—Hatchetman <08:54:03/12-17-50>

ORDER HERE

| | | | |
|---|-------------|------|------|
| ¥ | | 100% | PAID |
| ✈ | | ✉ | |
| 🔧 | | 👤 | |
| 👥 | SALESPERSON | | |



ORDER HERE



SALESPERSON

SECTION



NARCOJECT PISTOL & RIFLE

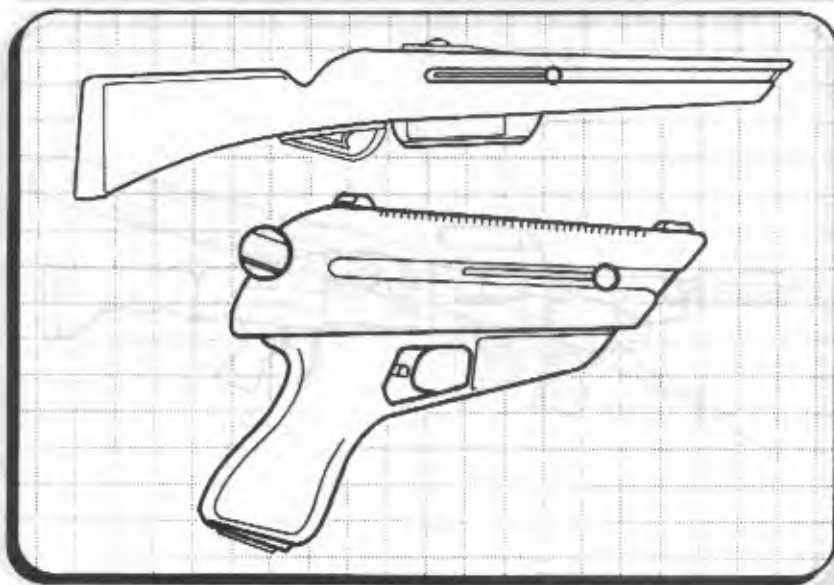

•The official Narcoject™ pistol and rifle!

The Narcoject™ pistol and rifle deliver patented Narcoject™ darts efficiently even under the most adverse combat conditions. The injection point of the dart can penetrate most armor reliably, ensuring target injection.

| | Type | Concealability | Ammo | Damage | Weight | Cost |
|-------------------|---------|----------------|--------|--------|--------|--------|
| Narcoject Pistol | Light | 7 | 5 (c) | ** | 1.5 | 600¥ |
| Narcoject Rifle | Shotgun | 4 | 10 (c) | ** | 3.25 | 1,700¥ |
| **Narcoject Round | | | | ** | .15 | 200¥ |

Usable only with the Narcoject Pistol or Rifle. (Weight per 10 rounds)
 **Delivers one dose of the Narcoject toxin (*Shadowrun* rules, page 147). Resolve using standard Ranged Combat procedure; however, roll only Combat Pool dice against the target number (reduced by Impact Armor). If the target does not generate more net successes, make a Body Test against the toxin to reduce its effect, but Armor and Combat Pool do not apply.



APDS AMMUNITION

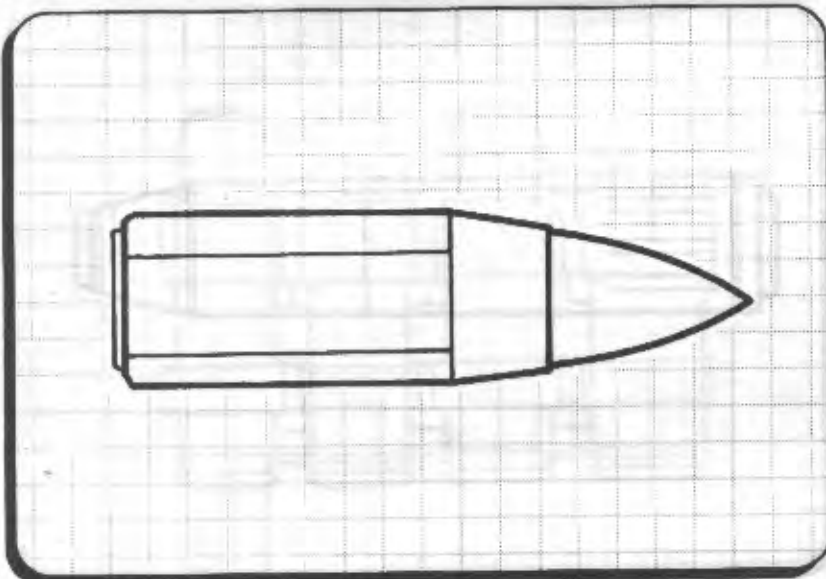

•Military grade ammunition for the street professional!

A definite must for the serious security or law-enforcement professional. Illegal in most places, APDS ammunition is considered essential to maintaining an edge in the streets. Available in all ammo sizes, the APDS rounds combine the armor-defeating capability of a high-tech neo-carbide round with the velocity-enhancing characteristics of the battle-proven discarding sabot system.

| | Damage | Additional Effect | Weight | Cost |
|-----------|--------|--|--------|------|
| APDS Ammo | — | Halves Ballistic Armor & Barrier ratings (when firing through only). Vehicle Armor reduces the power of APDS by one-half its rating (round down) and reduces the damage level by one level. | .25 | 70¢ |

>>>>[Does anybody know where I can get some of these? I stole two clips from the firing range at Fort Lewis, but burned them trying to get out of the place. Does anybody have any?]<<<<<

—Hatchetman <19:32:05/11-19-50>

>>>>[(Gee, I think there's a Samurai among us!) Tough stuff to find, Hatchet. The Government cracks down real hard on it. If you've got a security permit, you can get it...legally.]<<<<<

—FastJack <08:18:23/11-23-50>

ORDER HERE

| | | | |
|---|--------------------|------|------|
| ¥ | ☞ | 100% | PAID |
| ✈ | ✉ | ✉ | 👜 |
| 🔧 | 📄 | 👤 | 📈 |
| 👥 | SALESPERSON | | |



ORDER HERE



SALESPERSON

SECTION



CANNON AMMUNITION

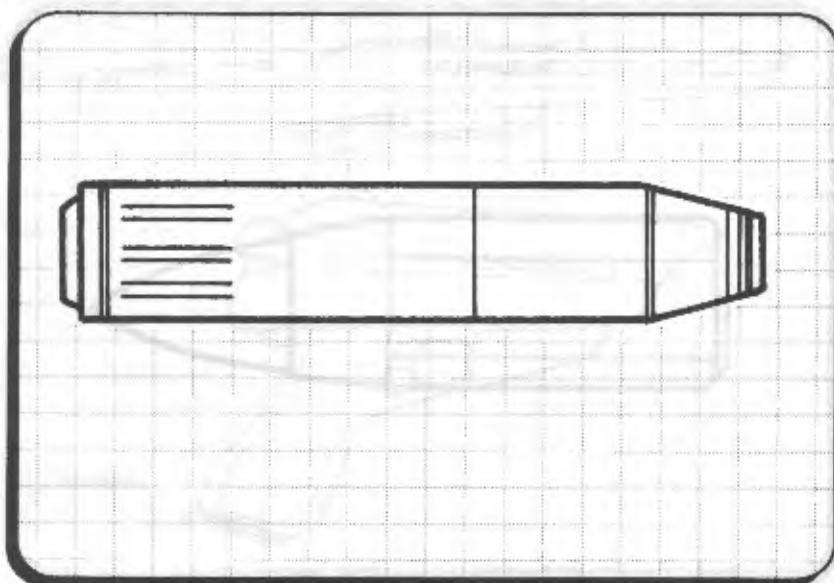

•Use the high-stability HDX superplast explosive compound!

Heat-stable explosive rounds for your favorite assault cannon. Available in individual rounds (10 pack) or belts of 100.

| | Weight | Cost |
|----------|--------|--------|
| 10 Pack | 1.25 | 450¥ |
| Belt 100 | 12.5 | 4,250¥ |



BELTED AMMUNITION

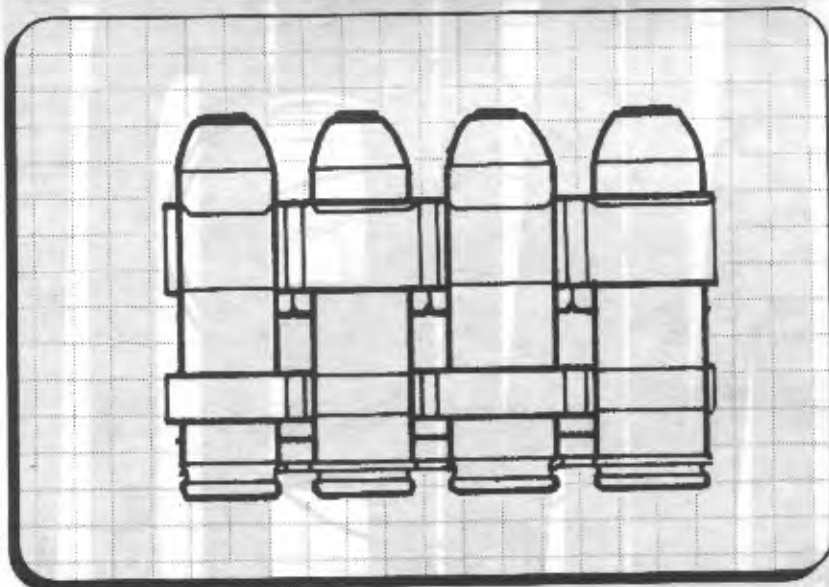

•Buy in bulk at a reduced cost!

Regular ammunition isn't the only ammo available in belted 100s. Check the list below for your favorite. Also available belted in 200s, 500s, and 1,000-round links.

| | 100 Belt | | 200 Belt | | 500 Belt | | 1,000 Belt | |
|----------------|----------|--------|----------|--------|----------|---------|------------|---------|
| | Weight | Cost | Weight | Cost | Weight | Cost | Weight | Cost |
| Regular Ammo | 5 | 175¥ | 10 | 325¥ | 25 | 800¥ | 50 | 1,575¥ |
| Explosive | 7.5 | 450¥ | 15 | 850¥ | 37.5 | 2,100¥ | 75 | 4,000¥ |
| Flechette | 5 | 850¥ | 10 | 1,600¥ | 25 | 3,800¥ | 50 | 7,500¥ |
| Gel Rounds | 3 | 250¥ | 6 | 475¥ | 15 | 1,050¥ | 30 | 2,000¥ |
| APDS Rounds | 2.5 | 650¥ | 5 | 1,250¥ | 12.5 | 3,100¥ | 25 | 6,000¥ |
| Assault Cannon | 12.5 | 4,250¥ | 25 | 8,350¥ | 62.5 | 19,500¥ | 125 | 37,000¥ |

>>>>[Yeah, just what I want for Christmas, a 1,000-round belt of explosive ammo. And let everybody know you're giving it to me. It'll keep the neighbors quiet.]<<<<<

—The Neon Samurai <16:31:31/11-29-50>

ORDER HERE

| | | | |
|----|-------------|------|------|
| ¥ | 📄 | 100% | PAID |
| ✈️ | ✉️ | 👁️ | 👤 |
| 🔧 | 📱 | 👤 | 📈 |
| 👤 | SALESPERSON | | |



GYRO-MOUNT SYSTEM

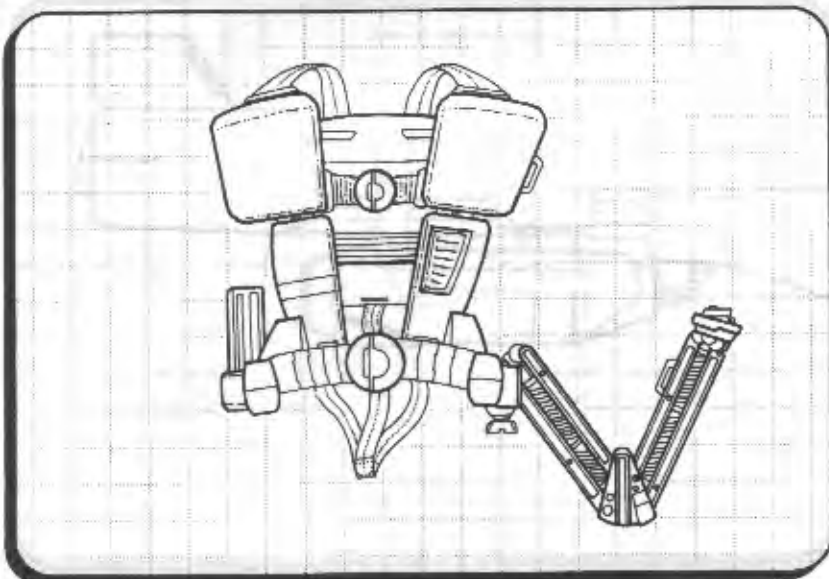

•Rugged, durable, precision gyroscopic stabilization!

This overbody, vest-style, gyro-stabilization system is perfect for those unwieldy weapons like the Ingram Valiant or the Ares MP Light Machine Gun. Consisting of an anchored shock harness and quick-detach battery cases, the Gyro-Mount System carries the weapon on an articulated arm attached to the shock harness at the waist. The weapon is mounted on the top of the gimbal arm and is capable of a full motion on three axes and through 160 degrees. The quad-cell battery system provides roughly three hours of continuous use at full load.

| | Mount | Concealability | Rating | Weight | Cost |
|--|-------------|----------------|--------|--------|--------|
| | Gyro-Mount* | Under -6 | 5 | 5 | 3,500¥ |
| | Deluxe Gyro | Under -7 | 7 | 7 | 7,800¥ |

*The Improved Gyro-Mount will negate recoil as well as movement modifiers up to the rating indicated. The wearer has access to one-half his normal Combat Pool and receives an additional +4 modifier to any attempt to engage in melee combat.

>>>>>[Hey, here's a neat trick to try. Put one of these on, pop your MP Light Machine Gun on top, and then run real fast. Sure, the gun stays nice and level, even at full-auto, but then try to turn. That's right, just a little side-step or two. Yeah, that's right. The gyros want to negate any kind of motion, even yours. Think of that when you're looking to hose the local slicer-dicer gang.]<<<<<<

—Steel Lynx <17:48:23/12-21-50>

ORDER HERE

| | | | |
|---|-------------|----|------|
| ¥ | 100 | 50 | PAID |
| ✈ | ✉ | ✉ | 🚚 |
| 🔧 | 📄 | 👤 | 📈 |
| 👥 | SALESPERSON | | |



ORDER HERE



SECTION



RANGEFINDER GRENADE LINK

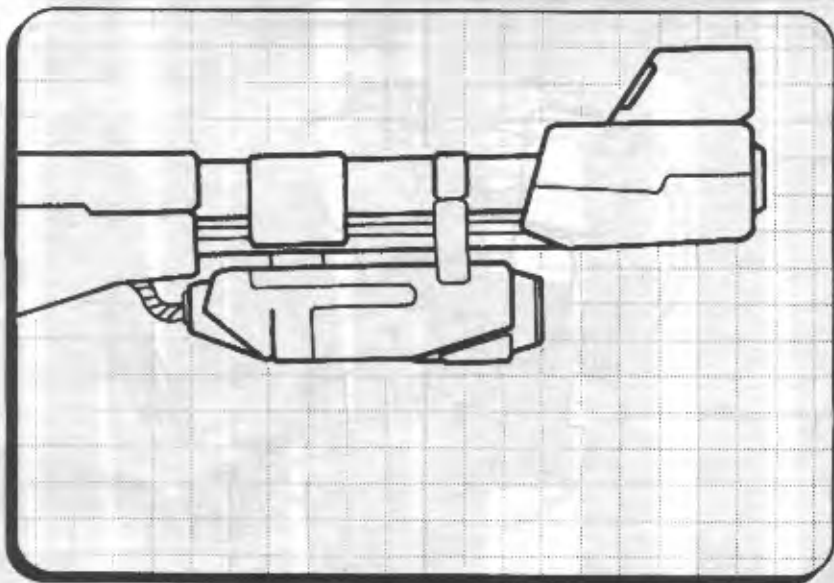

•Times mini-grenades for airburst, based on range!

Improve your mini-grenade accuracy with this rangefinder link. The rangefinder indicates the distance to the designated target and then "instructs" the mini-grenade to airburst after it has traveled that number of meters. The Ares Z2 Rangefinder or similar range-finding system is required for proper use. This system puts an end to scatter hazards. Compatible with most smartgun systems. Requires a modification to the linked grenade launcher (cost 300¥ and available at most weaponsmiths). Also requires the use of special Ares Air-Timed Mini-Grenades.

| | Concealability | Damage | Weight | Cost |
|------------------------|----------------|----------------|--------|------|
| Rangefinder Link | — | — | .1 | 750¥ |
| Air-Timed Mini-Grenade | 8 | As appropriate | .1 | 150¥ |



>>>>[Of course, it requires "special Ares Air-Timed Mini-Grenades."
Did you really expect anything else?]<<<<<
—The Neon Samurai <4:38:12/12-01-50>

RIOT-SECURITY SHIELD

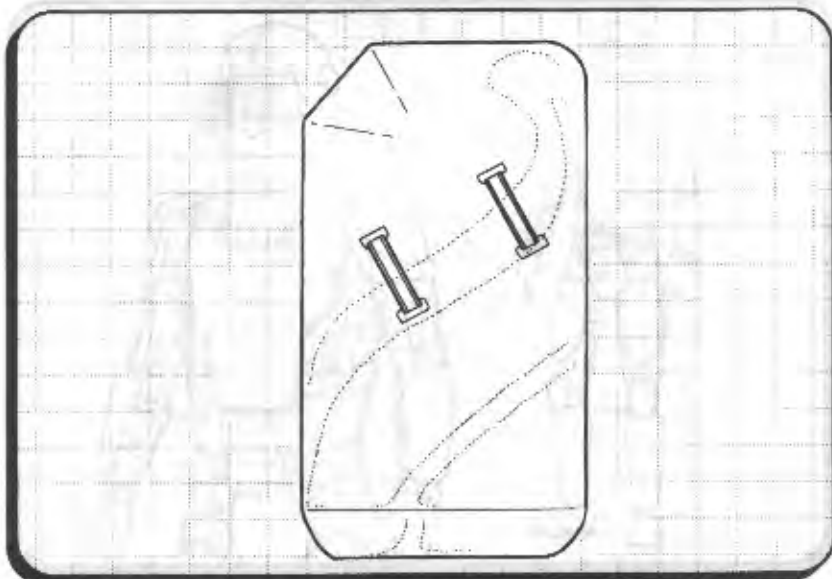

•Crystal-clear high-impact plasteel construction!

The Ares Personal Riot-Security Shield is the ultimate in see-through riot-security defense. Designed to be used one-handed, either right or left, the R-S Shield is perfect for street use or for high-threat situations when an additional degree of mobile protection is necessary. The R-S Shield is available in two sizes, small and large. The small shield is a half-body type ideal for use with standard police/security gear. It fits snugly into the trunk of most standard police/security cruisers. The large shield is designed for riot control and high-threat operations. Fully portable, it has been designed for easy deployment from most squad vehicles.

| | Ballistic | Weight | Cost |
|------------------|-----------|--------|--------|
| Small R-S Shield | 1 | 2 | 1,500¥ |
| Large R-S Shield | 2 | 3 | 3,200¥ |

*Ballistic Armor is cumulative with the armor of the user. Additionally, the defender receives a +2 modifier to melee attacks when carrying an R-S Shield. If used to bash, the shield has a damage code of (Str - 2)L Stun.



ORDER HERE

SALESPERSON

SECTION

SECURITY ARMOR

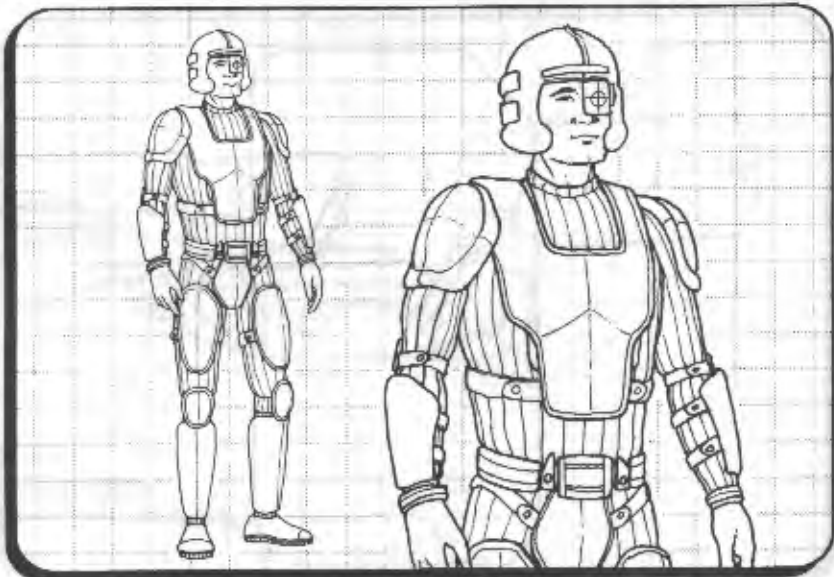

•Professional heavy armor for the security industry!

Kelmar Tech has released a new line of integrated security armor, and Ares America is the exclusive North American distributor. Available in either light, medium, or heavy weight, Kelmar Security Armor is the best full-protection body armor currently available. If ordered with two or more of the listed options, the customer receives a 15 percent discount on the package price. Purchase of four or more options entitles the customer to a 30 percent discount.

| | Concealability | Ballistic | Impact | Weight | Cost |
|-----------------------|----------------|-----------|--------|-----------|---------|
| Light Security Armor | NA | 6 | 4 | 9 + Body | 7,500¥ |
| Medium Security Armor | NA | 6 | 5 | 11 + Body | 9,000¥ |
| Heavy Security Armor | NA | 7 | 5 | 13 + Body | 12,000¥ |
| Security Helmet | NA | 1 | 2 | — | 250¥ |



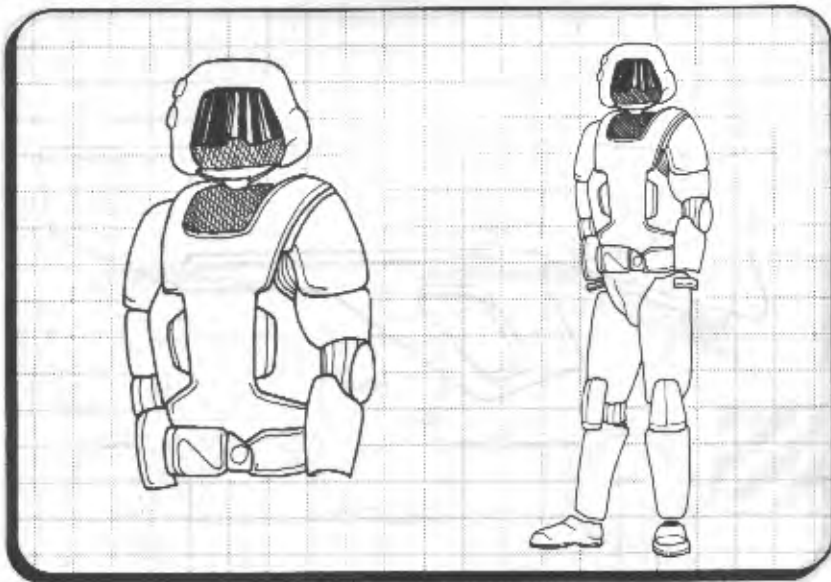

ORDER HERE

| | | | |
|---|-------------|---|------|
| ¥ | ☎ | 📄 | PAID |
| ✈ | ✉ | 👤 | 👤 |
| 🔧 | 🏠 | 👤 | 📈 |
| 👤 | SALESPERSON | | |

OPTIONS:

Helmet Vision Enhancement

- Magnification (x10) 650¥
- Low-Light 500¥
- Thermographic 700¥
- *Ultra-Sound 1,000¥
- **Smartgun 3,000¥
- *requires Ultra-Sound Sight
- **requires Smart-Gun connection

Communications

- Transceiver (Helmet) 2,500¥
- (Wrist) 2,500¥
- Tracking Signal (2)* 200¥
- (4)* 400¥
- (5)* 500¥
- Signal Locator 1,000¥
- Heads-Up Data Display (100 Mp) 1,000¥
- *Enables instant identification and location of all suits/team members.

Environmental Control (requires helmet)

- Respirator 500¥
- Chemical Seal* 12,000¥
- *Provides protection against liquid toxic waste contact.

>>>>>[Watch it, chummers. The Light, Medium, and Heavy Security Armors all fall under the new Armor Restriction Laws.]<<<<<<
—Hatchetman <03:23:19/01-05-51>



ORDER HERE



SALESPERSON

SECTION



NET-GUN

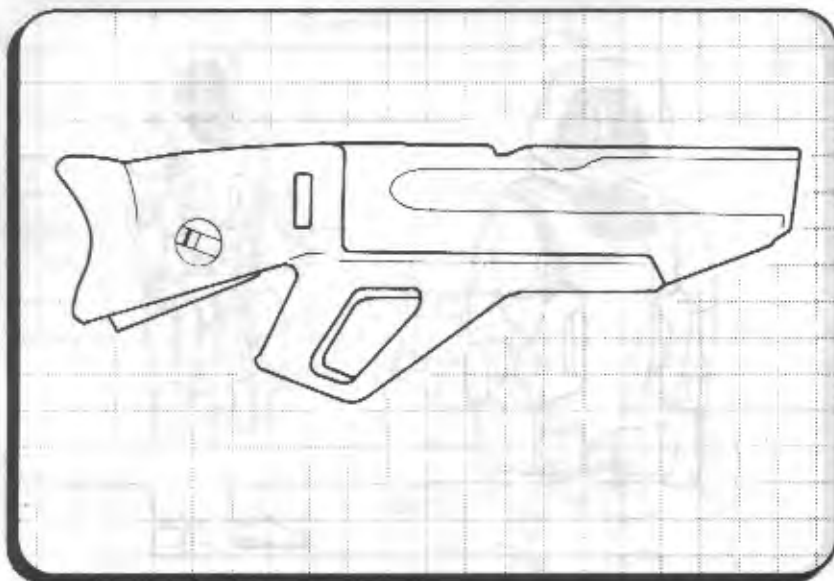

•Take them down, but don't take them out!

From Williams Technologies of New York, formerly Chandler, comes a non-lethal tool, the net gun. Firing an expanding fiber net that envelopes and restrains the target, this weapon is perfect for situations demanding less-than-lethal response. The normal version will restrain average and below-average size targets, while the extra-large variant has been designed for those larger than normal Orks and Trolls. Note that the extra-large net gun will fire normal nets. Comes with built-in laser sight.

| | Concealability | Ammo | Damage | Weight | Cost |
|----------------------|----------------|------|--------|--------|--------|
| Normal Net Gun | 4 | 4 | * | 4 | 750¥ |
| Large Net Gun | 3 | 4 | * | 4.5 | 1,150¥ |
| Additional Net Shots | | | | | |
| Normal | 7 | | | .5 | 150¥ |
| Large | 5 | | | .75 | 300¥ |

*The Net Gun entangles its victim, restraining him and forcing him to the ground. The victim must make a Strength Resistance Test against twice the number of extra successes generated by the attacker's success roll, with a Target Number of 5 for the Normal Net or 8 for the Large Net. If a Normal Net is shot at a large target, the victim's Target Number is 3. The target can use his Combat Pool. Once entangled, the victim is immobile and unable to act in any manner. He may attempt to escape from the net once per turn by making a Strength Resistance Test against the Target Number listed above, but with a -1 modifier for every turn he has been entangled.



RIOT-CONTROL VEHICLE

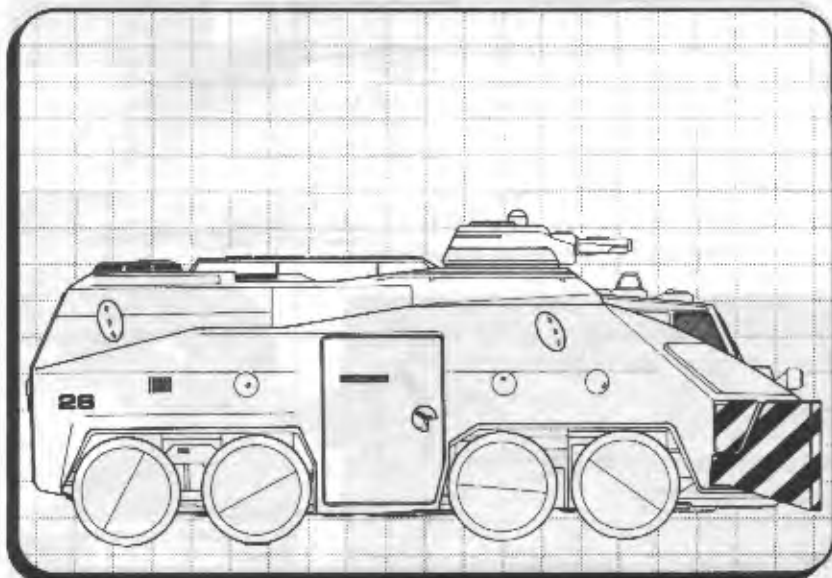

•Beyond a doubt, the ultimate urban security vehicle!

Based on the popular Ares Citymaster chassis, the Armored Riot-Control Vehicle can fulfill all urban security needs. Not only is the basic vehicle an upgrade of the Citymaster design, but add-on packages are available to adapt the vehicle to the needs of your particular urban situation. The Armored Riot-Control vehicle comes with a dual-mount roof-turret hardpoint and a pair of side gas-grenade launchers. The vehicle is set up to act as a command post and staging base for up to ten riot-equipped troops, but other configurations are available on request.

| | Handling | Speed | Body | Signature | Pilot | Cost |
|---------------------|----------|--------|-----------------------------|-----------|-------|-------------|
| ARC Vehicle | 4 | 40/120 | 5 | 5 | 5 | 3 650,000¥ |
| | | | Effect | | | Cost |
| Handling Packages | | | (-1 Handling) | | | +70,000¥ |
| | | | (-2 Handling) | | | +160,000¥ |
| Improved Engine | | | (50/150 speed) | | | +90,000¥ |
| Structural Upgrades | | | (+1 Body) | | | +95,000¥ |
| | | | (+2 Body) | | | +198,000¥ |
| Improved Armor | | | (+1 Armor; -10% base speed) | | | +170,000¥ |
| | | | (+2 Armor; -20% base speed) | | | +250,000¥ |
| Improved Signature | | | (-1 Signature) | | | +85,000¥ |
| | | | (-2 Signature) | | | +145,000¥ |
| AutoPilot Upgrades | | | (+1 Pilot) | | | +50,000¥ |
| | | | (+2 Pilot) | | | +120,000¥ |



ORDER HERE



SALESPERSON

SECTION



WASP and YELLOWJACKET

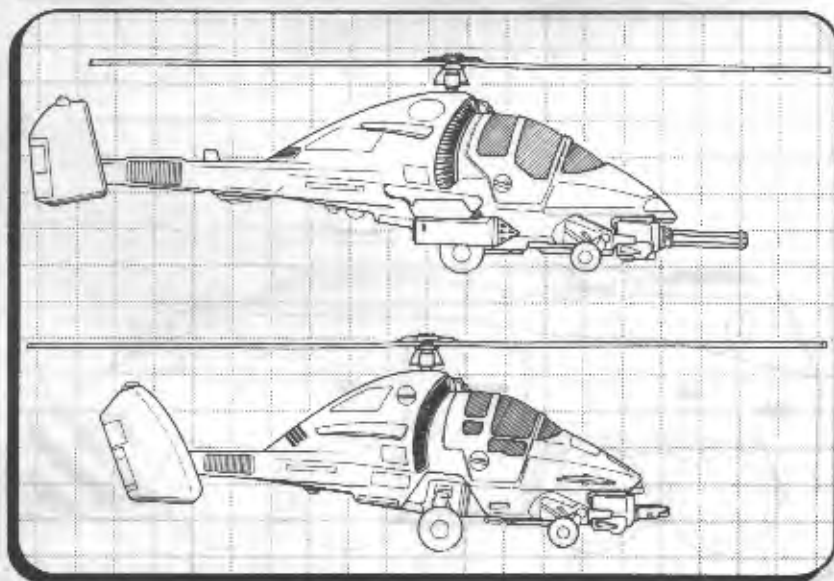

•The ultimate one-man, high-threat vehicle!

The Northrop PRC-42b Wasp and PRC-44b Yellowjacket are premier single-man rotocraft ideal for security and law-enforcement work. Designed as a military platform, the lighter, more nimble Wasp is well-suited to security support operations, while its slightly larger cousin, the Yellowjacket, is designed for high-threat, high-priority tactical support missions. Both the Wasp and Yellowjacket offer the pilot the option of cutting power to the rotors some distance away and gliding to the target on autorotation effect. Both platforms can deploy light glider-effect wings to assist in this. In this mode, the Wasp and Yellowjacket are virtually undetectable.

| | Handling | Speed | Body | Armor | Signature | Pilot | Cost |
|---------------|----------|--------|------|-------|-----------|-------|----------|
| PRC 42b Wasp* | 3 | 65/100 | 1 | 0 | 5 | 0 | 220,000¥ |
| Yellowjacket | 4 | 65/100 | 2 | 0 | 5 | 0 | 280,000¥ |

*The Wasp has a single-weapon firmpoint under the chin of the vehicle.

*The Yellowjacket carries either one under-chin hardpoint, or one hardpoint on each side of the vehicle(+30,000¥).



>>>>>[Hey, I'll bet that neat Long-Range Surface-to-Air Missile described a few pages back works real well against a Wasp or Yellowjacket. Ain't it nice of Ares to sell the measure and countermeasure all in one place?]<<<<<<

—Steel Lynx <23:41:45/01-02-51>

ORDER HERE

SALESPERSON

SECTION

3

COMMUNICATIONS LINK

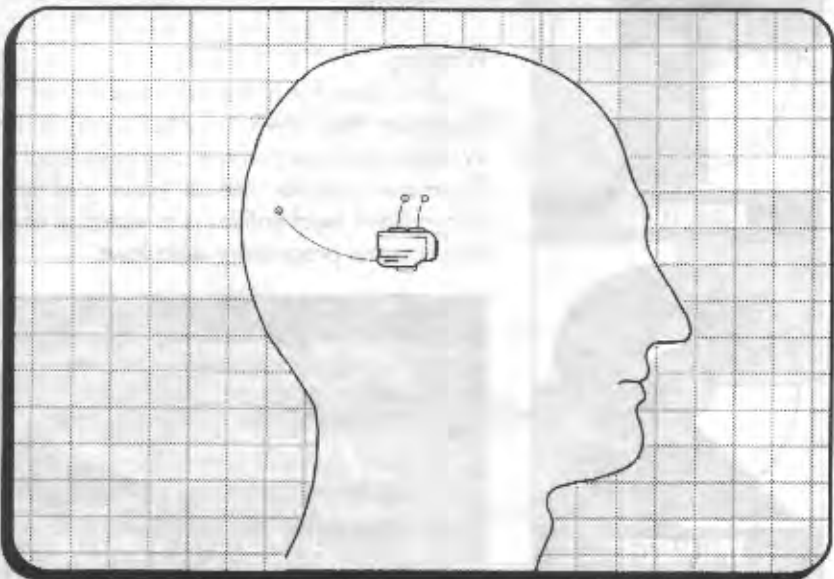

The perfect accessory for any internal radio transceiver or remote telephone system. The four different models allow the user to simultaneously monitor and access 2, 4, 8, or 10 channels of communication. With the proper links, these could be all radio, all telephone (voice only), or any combination. The comlink system allows you to:

- Monitor and access up to ten radio or telephone channels.
- Provide routing and switching to allow callers on separate channels.
- Selectively lock-out certain channels to screen audio clutter.
- Output onto a display system the status of all channels.
- Receive subtle visual notification of incoming calls.

| | Essence Loss | Cost |
|---------------|--------------|---------|
| Commlink-II | .3 | 8,000¥ |
| Commlink-IV | .3 | 18,000¥ |
| Commlink-VIII | .3 | 40,000¥ |
| Commlink-X | .3 | 60,000¥ |

The listed costs are for either a radio-only or telephone-only system. For a commlink system that handles both simultaneously (maximum ten channels), increase the base cost by 25 percent. Multiple systems cannot be linked together.

When inserted as part of a package with either a Radio Transceiver, Receiver, or Headware Telephone, the essence cost is halved.



>>>>[Definitely not for the easily confused.]<<<<<
 —FastJack <04.18.35/12-19-50>

CRYPTO CIRCUIT HD

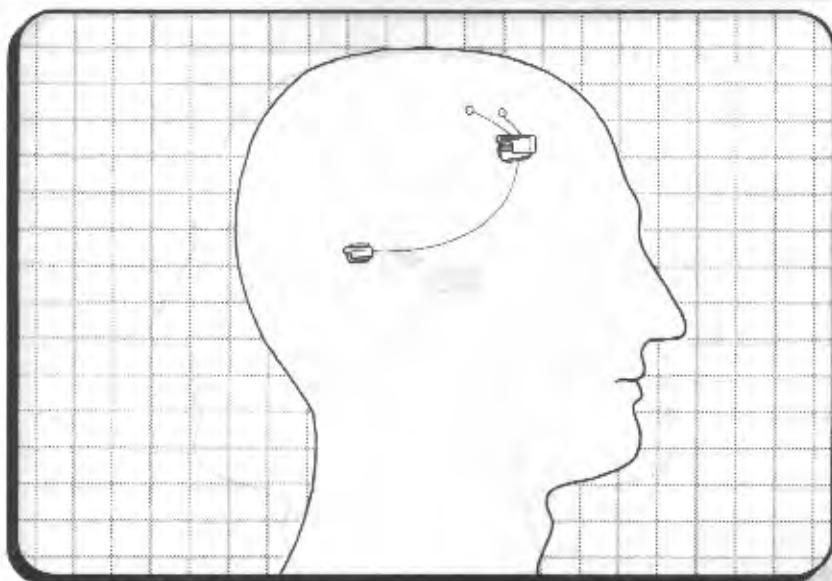

A Headware communications accessory, the Crypto Circuit HD allows transmission and reception of scramble-coded signals of varying levels of sophistication. Each signal transmitted by a Crypto Circuit system is layered with a sequenced code accessible only by other Crypto Circuit systems with the proper decoding sequence. The special code provides a potentially infinite variety of sequences.

This patented system is in use by military, governmental, and corporate security forces worldwide.

| Crypto Circuit HD | Essence Loss | Cost |
|-------------------|--------------|-------------------|
| Level 1-4 | .1 | (Level) x 10,000¥ |
| Level 5-7 | .1 | (Level) x 20,000¥ |
| Level 8-9 | .1 | (Level) x 30,000¥ |
| Level 10 | .1 | (Level) x 50,000¥ |

The Crypto Circuit HD is fully compatible with the commlink system and can provide coding and decoding functions for all channels. Both sender and receiver must be equipped with Crypto Circuit systems. The rating of the receiver's system must equal or exceed that of the sender.

The Crypto Circuit causes no Essence Loss when inserted as a package with either a Radio, Radio Receiver, or Headware Telephone system.

The Crypto Circuit system is also available for non-cyberware communication equipment at 50 percent of the listed price.



ORDER HERE



SECTION

3



HEARING AMPLIFICATION

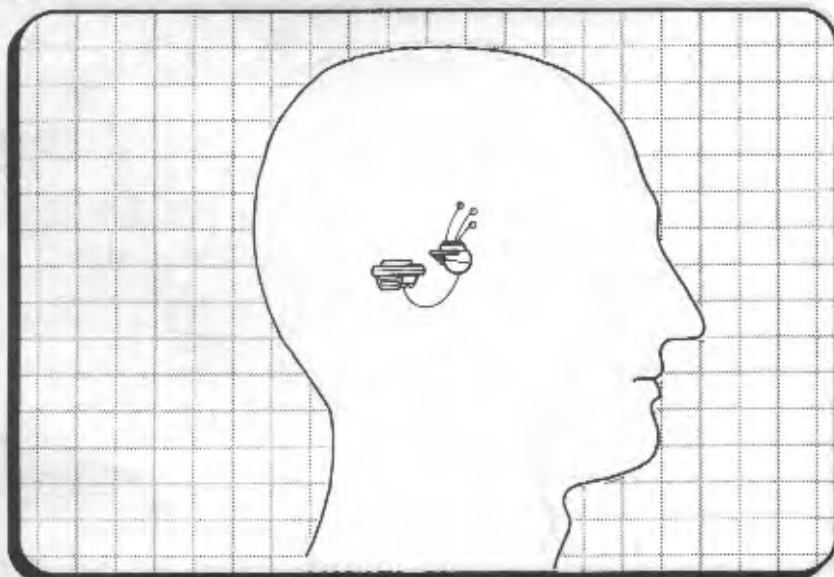

This headware enhancement system boosts the sensitivity of either natural or cybernetic hearing. This is a full-spectrum increase, not the mid-range (average voice frequencies) increase common with some systems. The effect of the amplification system is similar to that of a shotgun microphone, with the user able to hear as though he were ten times closer to the sound source. The Damper enhancement is highly recommended with all Hearing Amplification systems.

| | Essence Loss | Cost |
|-----------------------|--------------|--------|
| Hearing Amplification | .2 | 3,500¥ |



INTERNAL VOICE MASK

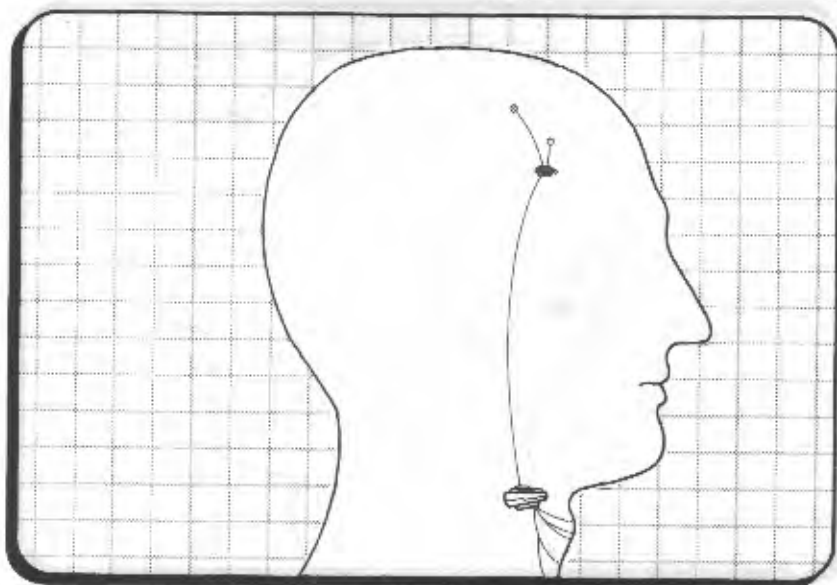

This cyber-speech accessory duplicates the operation of the external Voice Mask in every way, but with improved masking capability.

| | Essence Loss | Rating | Cost |
|---------------------|--------------|--------|--------|
| Internal Voice Mask | .1 | 2D6+2 | 7,000Y |

ORDER HERE

| | | | |
|----|-------------|---|------|
| ¥ | 📄 | 📈 | PAID |
| ✈️ | ✉️ | 📧 | 📦 |
| 🔧 | 📺 | 👤 | 📶 |
| 👥 | SALESPERSON | | |



>>>>[Wow! Now I can sound like Governor Shultz! Or...or...Max Foley! Or...or...Neil the Ork Barbarian! Or...or...Holly Brighton! Or...or...Maria Mercurial! Or...or...Dunkelzahn The Dragon! (And get my own resort... and my own trideo show...and...and...)]<<<<<

—Findler-Man <21:09:14/12-19-50>

>>>>[Excuse me?]<<<<<

—Dunkelzahn <02:17:51/12-28-50>

>>>>[????]<<<<<

—FastJack <18:23:28/12-30-50>



ORDER HERE



SALESPERSON

SECTION



RANGEFINDER

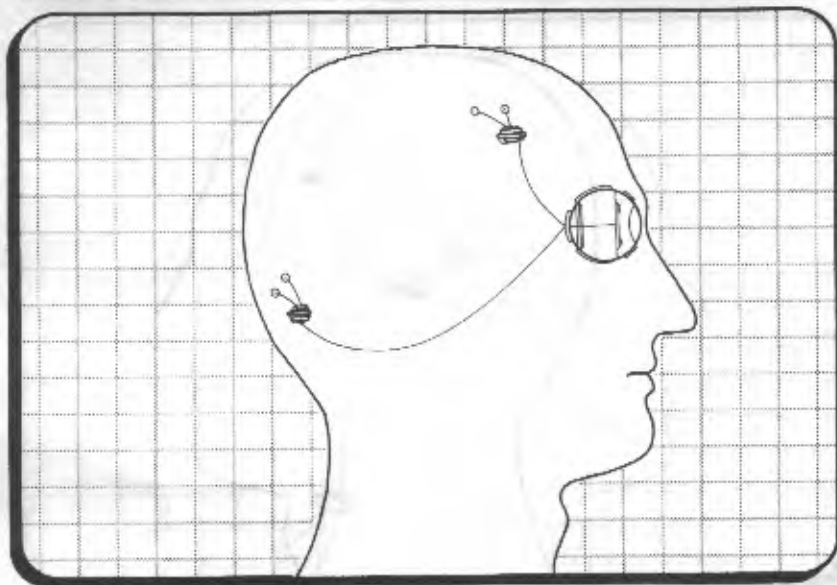

This cyber-sight accessory is identical to the weapon-mounted Rangefinder systems currently in use. When coupled with a display, the Rangefinder indicates the current range to target, whether it be to where the wearer is looking at or where his weapon is pointed if he is using a smartgun.

| | Essence Loss | Cost |
|-------------|--------------|--------|
| Rangefinder | .1 | 2,000¥ |



SCRAMBLE BREAKER HD

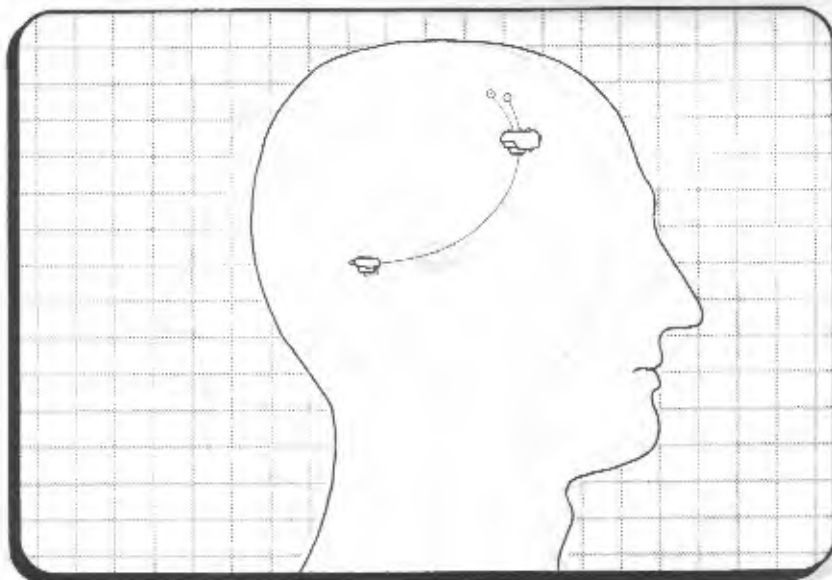

The ultimate in code-breaking technology, this headware accessory uses technology similar to that of the Crypto Circuit. The Scramble Breaker HD allows the wearer to attempt to penetrate the code of any encrypted signal and unscramble it.

| Scramble Breaker HD | Essence Loss | Cost |
|---------------------|--------------|-------------------|
| Level 1-4 | .2 | (Level) x 20,000¥ |
| Level 5-7 | .2 | (Level) x 40,000¥ |
| Level 8 | .2 | 600,000¥ |

The Scramble Breaker HD is compatible with the commlink system and can provide full code-breaking functions to all channels.

It causes only .1 Essence Loss when inserted as a package with either a Radio, Radio Receiver, or Headware Telephone.

The Scramble Breaker system is also available for non-cyberware communication equipment at half the listed price. The procedure for breaking a coded signal is identical to that used by a Data Codebreaker and Dateline Encryption System.

ORDER HERE

| | | | |
|---|-------------|-----|------|
| ¥ | ☎ | 100 | PAID |
| ✈ | ✉ | ✉ | 👤 |
| 🔧 | 📞 | 👤 | 📈 |
| 👥 | SALESPERSON | | |



ORDER HERE

SALESPERSON

SECTION

SELECT SOUND FILTER

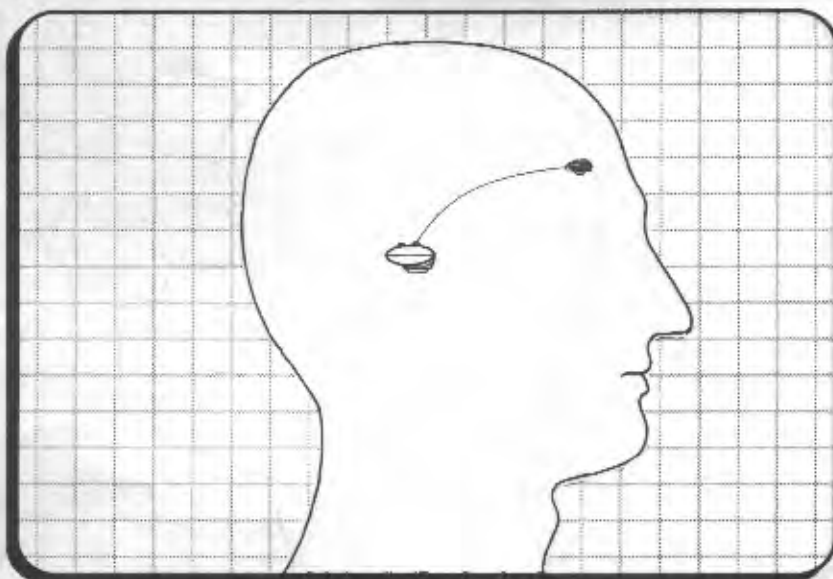

This audio accessory allows the user to selectively filter out certain sounds without affecting other sounds present. Uses would include filtering out environmental sounds in order to monitor a conversation more easily. The Select Sound Filter system comes in a variety of grades of technical sophistication and is compatible with all cyber-hearing systems and accessories.

| | Essence Loss | Level | Cost |
|--------------|--------------|-------|-----------------|
| Sound Filter | .2 | 1-5 | Level x 10,000¥ |

To use the Select Sound Filter, the user must make an Unresisted Success Test. He rolls dice equal to the filter's Rating against a Target Number based on the amount of noise the user wishes to filter compared to the total amount of noise present. If the noise to be filtered is only 10 percent of the sound present, the Target Number would be 2 or 3. If, on the other hand, it was 90 percent of the total sound present, it could be as high as 10 or 11. Fifty percent would be about 6. The exact numbers depend on the circumstances and the sounds involved. Louder sounds are far more difficult to filter than softer ones.



>>>>>[I am here to say that I have successfully used this wondrous device to filter out the rantings of my lady love during one of her frequent "get a real life" tirades. A heart-felt "10" from me.]<<<<<<
—The Neon Samurai <13:14:24/12-12-50>

SENSE LINK

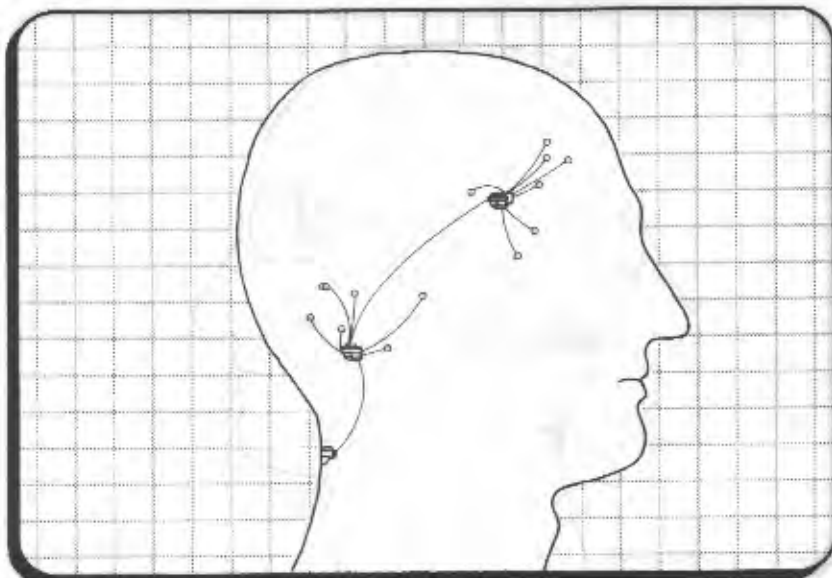

The Sense Link system is a basic Simulated Senses (Simsense) recording rig made affordable. Consisting of a series of phased neural sensors, the Sense Link can record and transmit the basic sensory impressions the wearer is receiving. The Sense Link can record full spectrum sight, sound, smell, taste, and touch, but does not record the wearer's emotions or attitudes. The Sense Link impression can be transmitted or recorded at a rate of 10Mp per 10 seconds of impressions. A Simsense player or cyberdeck is necessary to play back the recorded sensory impressions. Only a cyberdeck has the necessary electronics to play back a Sense Link transmission in real time.

| | Essence Loss | Concealability | Cost |
|----------------------|--------------|----------------|----------|
| Sense Link | 2 | NA | 300,000¥ |
| Internal Transmitter | .6 | NA | 80,000¥ |
| Sense Link Receiver* | NA | 3 | 90,000¥ |
| External Transmitter | NA | 4 | 30,000¥ |
| External Recorder | NA | 6 | 1,500¥ |

(without memory)

*Can only be attached to a cyberdeck or modified simsense player (non-portable).

>>>>[Oh, the possibilities...]<<<<<
—Findler-Man <21:13.32/12-18-50>

ORDER HERE

SALESPERSON



ORDER HERE

SALESPERSON

SECTION

3

VIDEO LINK

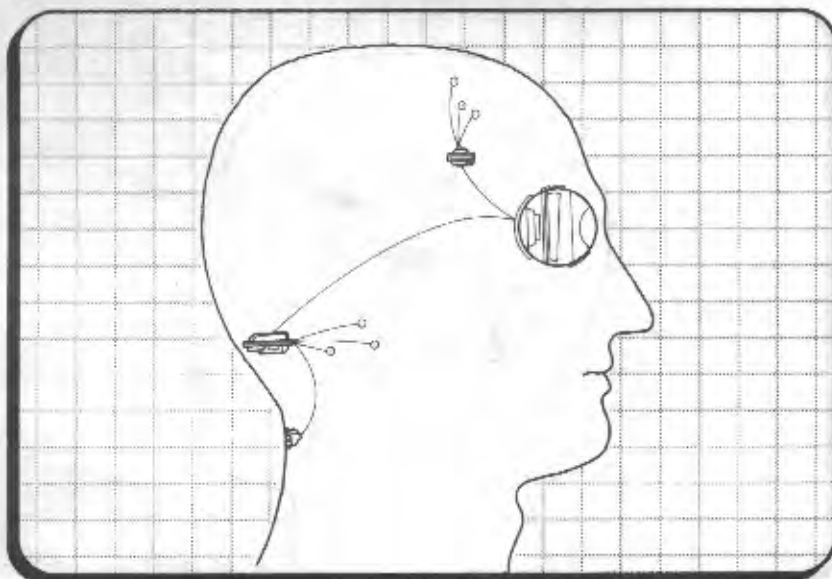

Until recently, a still video image was all that could be recorded from a cyber-sight system. A Video Link can transmit a live video image or can record it in headware memory or in a separate portable recorder. The image is preserved in three-dimensional color. If some form of cyber-hearing system is present, an audio track can be recorded as well. With 6Mp of memory, either internal or external, the user can record 1 minute of low-resolution video.

| | Essence Loss | Concealability | Cost |
|---------------------------------------|--------------|----------------|---------|
| Video Link | .5 | NA | 22,000¥ |
| Internal Transmitter | .4 | NA | 4,500¥ |
| External Transmitter | NA | 9 | 1,800¥ |
| External Recorder (without memory) | NA | 7 | 75¥ |

>>>>[Gawd, just wait until those crazy media people get a hold of this thing. Nothing will be sacred.]<<<<<
—Steel Lynx <13:21:23/12-31-50>

VISION MAGNIFICATION

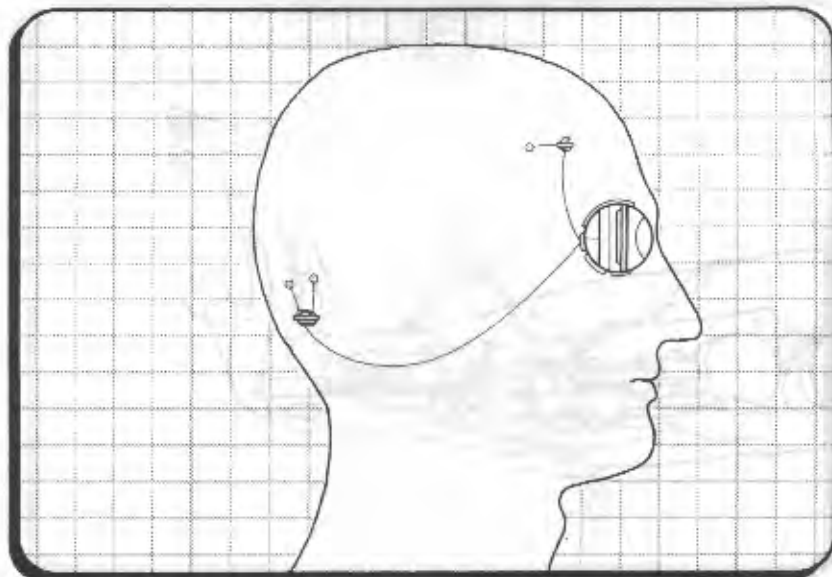

This cyber-sight enhancement magnifies the visual image in the same manner as binoculars or the lens on a camera. Vision magnification is available in two forms, optical and electronic. The optical system uses precision-crafted lenses to provide the magnification, while the electronic system uses a light-sensitive chip. The optical system produces a purer image with greater clarity but is cosmetically obvious when installed into an organic eye. The electronic system is concealed in all forms, but it produces a grainier image at higher magnification.

| | Essence Loss | Cost |
|----------------------------|--------------|---------|
| Optical Magnification 1 | .2 | 2,500¥ |
| Optical Magnification 2 | .2 | 4,000¥ |
| Optical Magnification 3 | .2 | 6,000¥ |
| Electronic Magnification 1 | .1 | 3,500¥ |
| Electronic Magnification 2 | .1 | 7,500¥ |
| Electronic Magnification 3 | .1 | 11,000¥ |

The Vision Magnification system is compatible with all other vision-enhancing systems. Both the optical and electronic magnification systems behave like Imaging Scopes of the appropriate rating. If exposed, optical magnification systems have a Concealability Rating of 9. If covered, they are undetectable.

>>>>[Hey, waddaya think they invented mirror shades for any-way?]<<<<<

—Findler-Man <19:23:01/12-18-50>



ORDER HERE



SALESPERSON

SECTION

3



CYBERGUNS

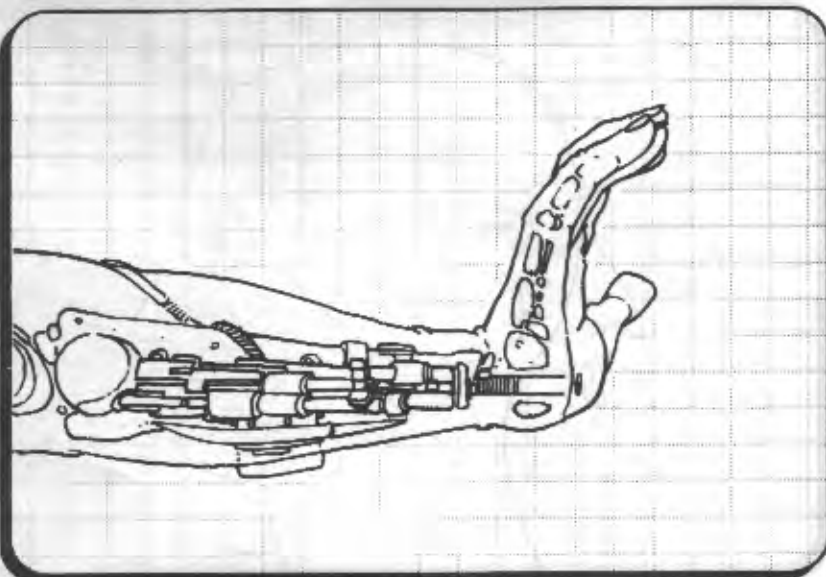

Designed by Fichetti Arms, the cybergun series of weapons was designed for installation in cyberarm. Light weapons in the series include the Hold-Out Pistol, Light Pistol, Machine Pistol, and Sub Machine Gun. The Heavy Weapon series includes the Heavy Pistol and Shotgun. All weapons fire through a port at the base of the palm. All have internal ammo loads, but can be reloaded. An external ammunition port is available for the automatic weapons (SMG and Machine Pistol), allowing them to take a full clip.

| Type | Concealability | Ammo | Damage | Weight | Cost |
|-----------------|----------------|---------------|--------|--------|--------|
| Hold-Out Pistol | 12* | 12 (Internal) | 4L(SA) | .3 | 250¥ |
| Light Pistol | 10* | 10 (Internal) | 6L(SA) | .75 | 650¥ |
| Machine Pistol | NA | 10 (Internal) | 6L(BF) | .8 | 900¥ |
| SMG | NA | 8 (Internal) | 6M(FA) | 1.25 | 1,800¥ |
| Heavy Pistol | NA | 6 (Internal) | 9M(SA) | 2.0 | 800¥ |
| Shotgun | NA | 4 (Internal) | 8S(SA) | 2.25 | 1,200¥ |

*The Concealability Rating reflects the chance of noticing the firing port on the cyberarm after a shot has been fired. If the firer is observed at the time of firing, the discharge will be obvious. A heavy weapon or cybergun firing at full auto will always be obvious. An ammo port is obvious only if a clip is sticking out of it.



BOOSTED REFLEXES

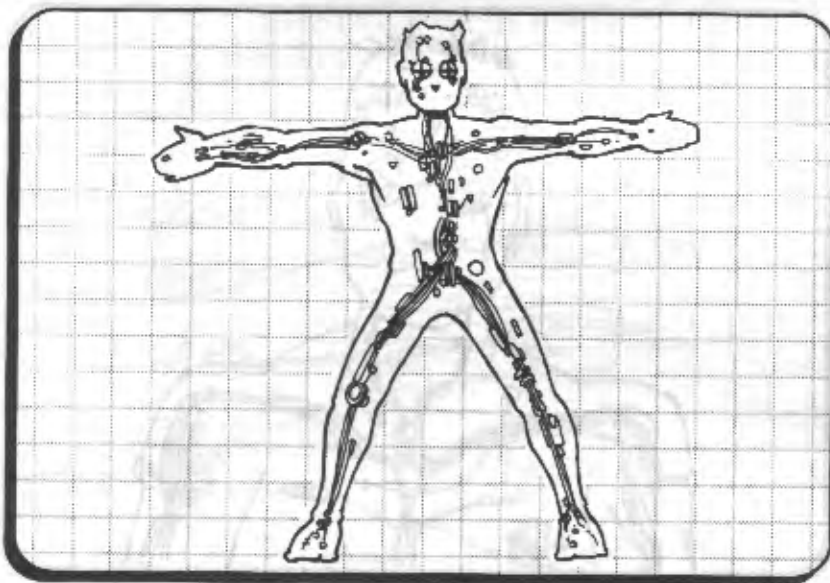

This one-time electro-chemical treatment and modification increases the body's natural reflexes without the need for cybernetic response amplifiers and neural-enhancement circuitry. The recipient of Boosted Reflexes, however, can never use Wired Reflexes or a Vehicle Control Rig. Boosted Reflexes cannot be upgraded.

| Boosted Reflexes | Essence Loss | Reaction | Initiative | Cost |
|------------------|--------------|----------|------------|---------|
| Level 1 | .5 | — | +1D6 | 15,000¥ |
| Level 2 | 1.25 | +1 | +1D6 | 40,000¥ |
| Level 3 | 2.8 | +2 | +2D6 | 90,000¥ |

ORDER HERE

SALESPERSON



>>>>[Great, just what we need.]<<<<<
 —Findler-man<23:21:42/12-17-50>



IMPROVED HAND RAZORS

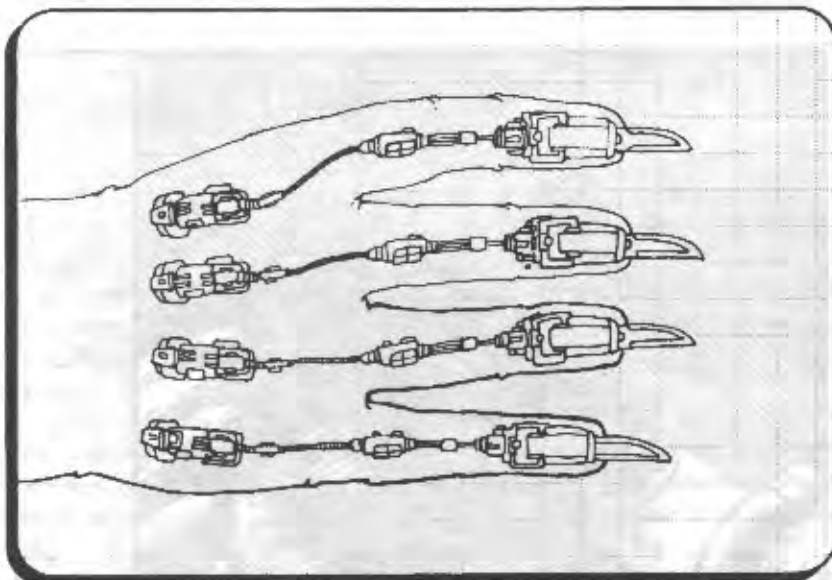

Wiremasters is proud to offer the new Wilkerson compression carbide blade replacements for Hand Razors. These replacement blades will fit all existing cyber-razor units currently manufactured. Please indicate manufacturer and model number when ordering.

| | Damage | Cost |
|---------------------|------------|--------|
| Improved Hand Razor | (Str + 2)L | 8,500¥ |

(To upgrade to the new blades, simply contact a Street Doc, or other appropriate individual, and pay your money. The replacement takes 20 minutes.)

>>>>[Hey, has anybody out there been able to figure out why a bunch of deckers are commenting on stuff we'll never have any use for? Just thought I'd ask.]<<<<<

—The Neon Samurai <15:31:32/12-19-50>

>>>>[Because somebody has to?]<<<<<

—FastJack <23:12:31/12-21-50>

>>>>[Because we're really vile, malicious, back-stabbing, rumormongers at heart?]<<<<<

—Fidler-Man <03:42:45/12-23-50>

>>>>[I'll buy that.]<<<<<

—NightFire <14:31:42/12-24-50>

>>>>[You would. You get paid enough. Oh and hey, Merry Christmas.]<<<<<

—FastJack <02:33:16/12-25-50>

ORDER HERE



WORKING THE STREETS

—Abridged from an article by the same name, written by William "Wedge" Harkwood, first published in the June 2050 issue of *Street Fighting Man*.

BLAM! A single gunshot and another all-too-wise razorboy gets geeked. Why? Because he was stupid. Because he thought he knew best. Because he refused to listen.

Every punker that hits the streets thinks he knows best. He thinks he's got the ultimate edge and that everybody else will just fold up when he pops those long chromium carbide blades. Wrong. They're going to laugh instead.

The moment you step out on the streets, you must immediately assume that you are in a war zone and that you are a target. On the street, paranoia is a way of life. Without it, you're pizza. Assume that every situation, every deal, is potentially life-threatening and you just might live to see the morning.

There is no clean and fast way to work the streets. Nobody has a patented method of survival, but keeping certain things in mind just might make life a little safer.

Assume that everything you do is part of your own personal little war. All this drek about "Zenning" through life is garbage. Might as well put a bag over your head and dance in traffic.

Think about what you are doing. Plan ahead. Study your options. Try to out-think your opponent. Consider what he's going to do next, and what you can do to be ready for it.

Know your enemy. By learning all you can about him, you can begin to understand how he thinks and is likely to react. Knowledge is power.

Always check with your Contacts. Even if the deal looks so clean it squeaks, check it out. Even if it's your big-buddy older-brother sliding it to you, check it out. I'm not saying you should always believe everything you hear, but put your ear to the pavement and listen anyway.

Pay attention to your surroundings. Know your territory. Too many young razorboys assume they can get away with carrying their Kingslayer Assault Cannons casually over one shoulder while window-shopping along Money Street.

Laws and enforcement vary, depending where you are. Procedures can change from block to block and from cop to cop. If you're in a neighborhood that the cops like, play it safe, take it easy, and keep it concealed. The worse the neighborhood, the more the cops are going to let things slide. A heavy weapon of any kind is an excuse to call out the riot squad, and an assault rifle is worth at least three carloads of back-up, and maybe even a light chopper.



INFORMATION



SALESPERSON



SECTION

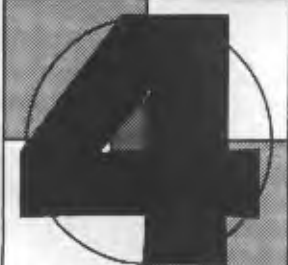

APPENDICES

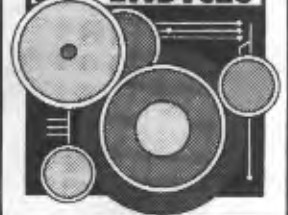

Carrying big guns and obvious armor is just asking for trouble, in any neighborhood. In many places, an obvious weapon or obvious armor make you an immediate target.

Understand how this war of yours is going to be fought. It serves no purpose to have your H&K 227 in perfect working order if your enemy is going to shut you down with long-range magic. Study the options, consider the possibilities.

It also serves no purpose to take on an obviously superior foe head-on. Use hit-and-run tactics whenever possible. Keep your engagements short and sharp. Use the shock of violence to your advantage and be gone before that shock wears off. Leave the protracted open-field fighting to the military idiots who have the manpower to soak up the casualties.

If you do get into combat, try to get out of it as fast as you can. There is too much uncertainty in the chaos of battle to guarantee any result. If you must fight, control it. Choose the terrain, choose the weaponry, choose the participants.

Do not let your opponent set the pace. Be active, not reactive. Force his hand, rather than letting him force yours. Gain and hold the initiative.

Harass your opponent. Anger may lead to error.

The only thing you can be certain of is what you can do. Everything else is suspect.

And never, ever, be dumb enough to think you've won.



CYBERWARE DAMAGE

Don'tcha just hate it when that happens?
—Kid Stealth

At some point, the unthinkable always occurs. It may be the result of a particularly lethal blast of autofire, a former friend's wandering monowhip, or the front bumper of a barrelling CityMaster. Either way, sometime, somewhere, when you least desire it, your cyberware is gonna get broke.

How can this happen?, you ask. Very easily, comes the reply. Whenever a cyberware-bearing body takes traumatic damage, there is a chance, based on the severity of the wound, that one or more pieces of cyberware will become damaged and dysfunctional. In *Shadowrun*, a traumatic wound is any *single* wound of Serious or Deadly severity. That Serious or Deadly wound must be from one bullet, one blow, or one zap of magic, and it must be *physical* damage.

DETERMINING SYSTEM DAMAGE

When a Serious Wound is done, roll 1D6 and subtract 4. If the wound was Deadly, roll 1D6 and subtract only 2. The result is the number of *potential* cybersystems that might be damaged as a result of the wound. Roll that number of times against the table that follows. First, roll 1D6 to determine what type system took damage, and then roll 2D6 to identify the specific system.

DAMAGE TABLES

Determine System Type

| | |
|----------|------------|
| | 1D6 |
| Headware | 1-3 |
| Bodyware | 4-6 |

Determine Specific System

| | |
|-------------------|------------|
| Headware | 2D6 |
| Cybereye | 1-3 |
| Data/Chipjack | 4-5 |
| Memory System | 6-7 |
| Other Cybersystem | 8-9 |
| Cyberear | 10-12 |

| | |
|-------------------|------------|
| Bodyware | 2D6 |
| Cyberarm | 1-3 |
| Reflex Modifier | 4-6 |
| Skillwire System | 7-8 |
| Other Cybersystem | 9 |
| Cyberleg | 10-12 |



INFORMATION



SALESPERSON



SECTION



APPENDICES



If a damage roll against one of the above tables results in a piece of cyberware that the damaged character does *not* have, then a "No Result" effect is achieved, and you got away lucky, chummer.

DAMAGE TABLE DEFINITIONS**HEADWARE****Cybereye or Cyberear**

This category covers all eye/ear devices and modifications, including those made to natural, organic eyes/ears. Retinal Duplication and Cosmetic Modifications are not affected. The Cybereye or Cyberear should be counted separately, in addition to its linked accessories. If the Eye/Ear itself fails, all its accessories also fail.

Data/Chipjack

Each jack should be counted individually.

Memory System

This category includes all data storage and memory access systems, excluding Data and Chipjacks and Cortex Bombs. Count each memory storage individually. If any memory access or access-restricting systems fail, that accessory no longer serves its original function.

Other Cybersystem

This category covers all head-based Links, Displays, and Communication systems. Each should be listed separately. This category *does* cover smartgun links, which can also be damaged under Bodyware.

BODYWARE

Muscle Replacements, Dermal Armor, Boosted Reflexes, and Filters are never affected.

Cyberarm/Leg

This category includes all arm or leg-based cybernetic devices, as well as an entire cyberlimb, if present. If this category is indicated, determine whether it is the right or left limb (1 - 3 = Right; 4 - 6 = Left) and then count appropriate cyberware systems. The cyberlimb itself should also be counted. If it fails, all devices linked into it also fail. Program Carriers are an Arm Accessory and should be included with the appropriate limb.

Reflex Modifier

This includes Wire Reflexes and Vehicle Control Rigs. Boosted Reflexes are not affected.

Skillwire System

This category covers all Skillwire-like, chip-based skill neuro-system links.

Other Cybersystem

This includes any and all systems not covered by one of the above categories, including cyberware mounted in odd places, and Speech and Voice modification systems.

Any Damaged system must be Repaired (see page 96). If the same system is damaged more than once before it is repaired, then it must be replaced.

If the damaged system is Second-Hand Cyberware, any damage to the system results in a complete loss of the cyberware, which must be fully replaced. (See **Upgrading Cyberware**)

Karma can be spent to purchase a re-roll if a damage result is undesirable. The cost is 1 Karma Point per re-roll. This can be repeated as often as the player wishes until he gets the desired result or else runs out of Karma.

DETERMINING SUBSYSTEM DAMAGE

The method for determining exactly which subsystems will be affected is different for each character. After determining which specific system has been affected, make a list of the character's various pieces of cyberware that fall under that category, using the following guidelines:

- If there is only one subsystem under the category, that system is damaged.
- If the category includes two systems, there is a 50 percent chance that either one will be affected. Roll 1D6. A 1-3 result damages System A; a 4-6 result damages System B.
- If there are three systems in the category, the chances are as follows: 1-2 result damages System A; 3-4 damages System B; 5-6 damages System C.
- If there are from four to six systems, the chances are:
 - 1 = System A 4 = System D
 - 2 = System B 5 = System E (if none, roll again)
 - 3 = System C 6 = System F (if none, roll again)
- If there are more than six systems, the following may be used as a guideline:

Chart 1

- 1= System A
- 2= System B
- 3= System C
- 4= System D
- 5= System E
- 6= Roll on Chart 2

Chart 2

- 1= System G
- 2= System H (if none, roll again Chart 1)
- 3= System I (if none, roll again Chart 1)
- 4= System J (if none, roll again Chart 1)
- 5= System K (if none, roll again Chart 1)
- 6= System L (if none, roll again Chart 1)



INFORMATION



SALESPERSON



SECTION



APPENDICES



CYBER REPAIR

Sure I can fix it, but it's gonna cost ya.
—Street Doc Credo

When a piece of cyberware gets broken, odds are that its owner will want to have it fixed. (Walking around with broken cyberware dangling from one's body can be downright embarrassing!) A Technician (or anyone) with Biotech (B/R) can do the job. We'll be nice and assume that no real surgery is necessary.

The Base Time for repair of a piece of broken cyberware is equal to the Base Essence (unmodified Essence) Cost of the broken system, multiplied by 2 hours.

The repairer has a repair Target Number based on the severity of the wound that caused the original system failure. A Serious Wound has a Target Number of 4, a Deadly Wound of 8.

Use the modifier table given with the Build/Repair skill use description on pp. 153-4 of the *Shadowrun* basic rules.

If a repair is made on Alpha or Beta Grade Custom Cyberware, double the final Target Number for Alpha Grade and triple it for Beta Grade.

Each success generated reduces the repair time required. Divide the Base Time by the number of successes to determine the actual time.

The cost for the repair has two factors: Parts and Labor. If the wound is Serious, the Parts cost is equal to the cost of the original cyberware multiplied by .15. If the wound is Deadly, its repair cost is equal to the original cost multiplied by .35.

Labor is based on the repairer's Skill Rating. The Base Charge is equal to 50¥ for each skill point per hour. So, a technician with a Skill Rating of 6 would charge 300¥ per hour for his services. Technicians with a facility up-to-date enough to warrant Superior on the Build/Repair Modifiers Table also charge an additional usage fee, usually an amount quadrupling his charge (x4).

The Labor charges assume that the character cannot fast-talk a friend into doing the fix for him. It is also conceivable that a Technician or Street Doc could charge far in excess of the base charges listed above. It is, after all, a seller's market.



UPGRADING CYBRWARE

UPGRADING OR REPLACING CYBERWARE

Whatsa matter, the old stuff ain't good enough no more?
—Lou Welby, Street Doc

At some point, you may want to upgrade the piece of cyberware you are currently wearing, or may have to replace it. In either case, the procedure is the same.

All cyberware upgrades or replacement procedures are **Elective Surgery**, as described on page 144 of the **Shadowrun** rules. No medical rolls are necessary for the surgery itself, for we assume technology has progressed to a state where table deaths are very rare.

The attending physician (or whoever is performing the surgery) does make a roll to determine how well he performed the surgery. Good surgery can reduce Essence Cost, while sloppy surgery can increase it. The character performing the surgery must make a **Biotech (B/R) Skill Roll** against a Target equal to 10 minus the new Essence of the character undergoing surgery. His new Essence is the rating he receives if the current surgery occurs without difficulties. After the Surgery Roll, consult the Essence Cost Table, below.

ESSENCE COST TABLE

| | |
|---------------|--------------|
| No Successes | +15% Essence |
| 1 Successes | +10% Essence |
| 2-3 Successes | no change |
| 4-5 Successes | -10% Essence |
| 6 or greater | -20% Essence |

Apply the percentage listed to the Essence Cost to determine the actual Essence Cost. If the Essence Cost would leave the character with Essence of less than 0, surgery will be suspended prior to death, the cyberware left uninstalled, and the character's Essence at 0.

As an option, the gamemaster may choose not to inform the player of his character's current new Essence. In this case, the player would only know what his Essence is as a result of successful surgery. It is then his option to take any further risks with additional surgery down the line.



INFORMATION



SALESPERSON



SECTION



APPENDICES

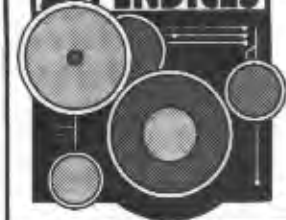

CUSTOM CYBERWARE

It may be good, but there's always better.

—Dr. Aidan Jarmani

Nothing gleams brighter than custom chrome. Go deep enough into the cities of Chiba, San Francisco, Brussels, Tel Aviv, Manhattan, Oslo, or Seattle, and you'll find them: Shadow Clinics.

A Shadow Clinic is the place to obtain the best, smoothest, slickest, and most expensive cyberware available. Most of it is not even made from recognizable technology, but it works. The name Shadow Clinic comes from the fact that they're unlicensed and underground, existing deep in the shadows. The established medical profession definitely disapproves of the "experimental medicine" they practice.

So, what exactly can custom cyberware do for a character? First, it is better quality, usually some bio-technological metaconstruct, meaning it costs less Essence. It is also more resistant to damage, but far more difficult to repair.

The Shadow Clinics to which the characters are most likely to have access offer basic levels of Custom Cyberware: Alpha and Beta, with Alpha being the cheaper, less-efficient grade.

| | Essence Reduction | Cost Multiple | Damage Resist |
|-------|-------------------|---------------|---------------|
| Alpha | -20% (x.8) | x3 | 5/6 |
| Beta | -40% (x.6) | x7 | 4/5 |

ESSENCE REDUCTION

Reduce the amount of Base Essence Cost by the percentage listed (or use the Multiple given in parenthesis.) Round all numbers up. Essence Cost may never be reduced below .05 in this manner.

COST MULTIPLE

Multiply the cost for the cyberware by the number indicated. Remember that this is only the cost for the actual piece of hardware, and does not include doctor's fees and hospitalization.

DAMAGE RESISTANCE

The first number given is the target for resisting damage from Serious Wounds, and the second from Deadly Wounds. When a piece of custom cyberware is damaged, roll 5 dice against the Target Number indicated above. Only one success is necessary for the damage to be ignored completely.



Doctor's fees and hospitalization are 50 times the rates listed on page 145 of the **Shadowrun** basic rules. You cannot have the work done at the clinic and then transfer to a cheaper place for recuperation.

FINDING A SHADOW CLINIC

This could easily become an adventure in itself. Shadow Clinics do not advertise, they are not listed in professional journals, and they do not pass out flyers on the streets. The only way to find one is to know someone. There are two avenues: The Streets and The Corps.

The Streets

Very few people on the street know Shadow Clinics to be anything more than rumor. Contacts likely to know the location of one are the Fixer, Street Doc, and Yakuza Boss, as well as any other well-connected Contact the gamemaster deems appropriate.

Just because a character knows the appropriate Contacts does not mean the Contact knows where to find a Shadow Clinic. For a start, the gamemaster can make an Etiquette (Street) Success Test for the Contact against a Target Number of 12 for an Alpha Grade clinic, or 15 for a Beta Grade. Only one success is necessary.

If the Contact does not immediately know of a Clinic, he might (if the player character is convincing enough and has a large enough cash-flow) try to find one. To do so, add together the Contact's Intelligence Rating and the lower of either his Charisma or Etiquette (Street) Skill Ratings. Roll this combined "pool" against the appropriate target listed above. This time, however, it requires two successes to find an Alpha Clinic, and three for a Beta Clinic. The Base Time for this search is five days. Divide the total number of successes into the Base Time to determine the actual time.

The Corps

The Corporations approach Shadow Clinics from a different angle, and so may have an easier time finding one. Appropriate Contacts include the Fixer, Mr. Johnson, Company Man, and the Corporate Official.

The procedure is the same as described above, except the Target Number for an Alpha Clinic is 11, and for a Beta clinic it is 17.

Even after the character has located a clinic, it does not mean he can easily get to it. (Some player characters may have heard of one in Chiba, Japan that accepts foreign clients!) Characters may have to go through hell to actually get there and find it, but that will depend on how much grief the gamemaster wants to add to the already gritty way of life in **Shadowrun**. And be prepared to spend plenty of nuyen.

Sometimes, if a character is lucky, a corp will pick up the Shadow Clinic's tab for him. But oh, what a favor he'll owe.





CHEAP CYBERWARE

BARGAIN BASEMENT CYBERWARE

I swear, a little old lady from Pasadena. Would I lie to you?
—Dynamic Dave, Cyber Salesman

Yes, it is possible to get second-hand cyberware. It costs 50 percent less, but is prone to breakage. Installation and Essence Cost are the same as for a normal piece of cyberware.

Second-hand cyberware does not necessarily break every time a character uses it—only when it is crucial that it not break. Once per adventure (and only once), the gamemaster may have the player make a Resistance Test for the piece of cyberware. Roll 5 dice against a Target Number of 4, modified by circumstance as the gamemaster sees fit. (For example, if it is a cheap cyberarm and the character is dangling from it off a building, the Target Number could go as high as 8.) Normal Karma rules apply, but it costs 2 points of Karma per die re-rolled.

If the piece of second-hand cyberware fails, it must be replaced. No repair is possible.

The potential failure of a piece of cyberware should only be used to increase dramatic tension, and not to harass the players. It is quite possible that it would never be appropriate at any time during the adventure for a particular character to make a roll against that piece of cyberware. So be it.

This option should only be used to add fun to the game, and not as an excuse for sudden character mortality.

SAMURAI ARCHETYPES

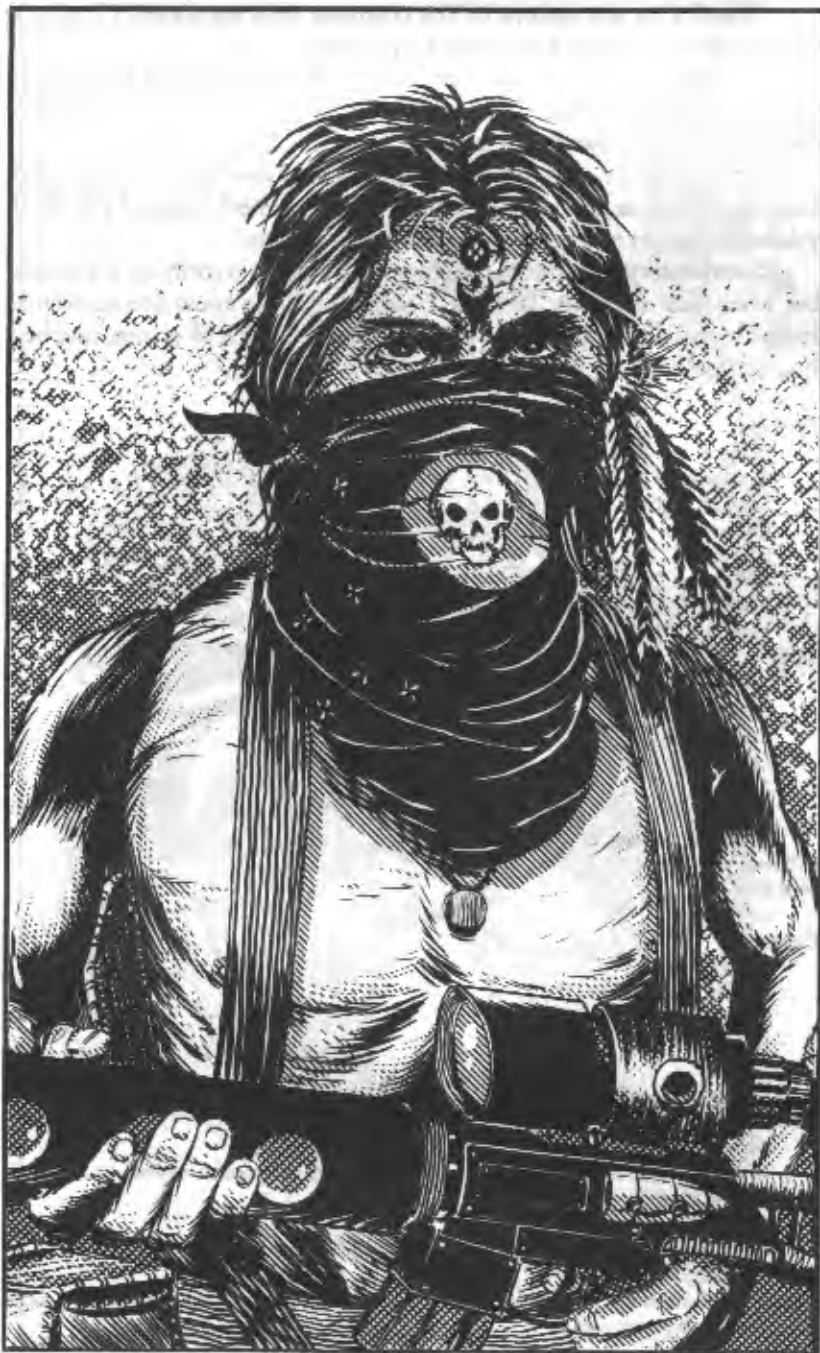

INFORMATION



SALESPERSON

SECTION



INFORMATION



SALESPERSON

SECTION



APPENDICES



DWARF STREET SAMURAI

"Short? Can you believe it? The chummer calls me short?! I'll tell you what's going to be short, my friend—your life.

"I may be lacking in height, but I can bench-press you and a '45 Chevy without breaking a sweat. Odds are I can outdraw you, too. Got a piece of microtronics in my head that says so.

"So you can be rude and I'll stick your feet in your ears, or we can talk business. You have got business, haven't you, chummer? 'Cause if you don't, you better have a real good reason for bothering me."

Commentary: The dwarf street samurai may be a rarity on the streets, but when you meet one, beware. Even those in the know are sometimes fooled by his slight stature and sluggish movement. It's all a ruse, and he's hoping you'll fall for it.

Attributes

Body: 6
 Quickness: 4 (5)
 Strength: 4 (5)
 Charisma: 2
 Intelligence: 2
 Willpower: 2
 Essence: 1.75
 Reaction: 3 (5)

Skills

Armed Combat: 6
 Athletics: 4
 Etiquette (Street): 4
 Firearms: 6
 Stealth: 1
 Throwing Weapons: 3
 Unarmed Combat: 6

Initiative: 5 + 2D6

Dice Pool

Combat: 4

Cyberware

Wired Reflexes: 1
 Muscle Replacement (1)
 Smartlink
 Radio Implant

Contacts

Choose (3) Contacts

Gear

Armored Jacket
 Browning Hi-Power (with external smartlink, 100 rounds regular ammo)
 Middle Lifestyle
 Maglock Passkey
 Uzi III (with external smartlink, 100 rounds regular ammo)

Starting Cash: 10,400¥

Notes: The dwarf street samurai has natural thermographic vision, and a bonus of +2 to his Body against Diseases only.



INFORMATION

SALESPERSON

SECTION

103

INFORMATION



SALESPERSON

SECTION

4

APPENDICES

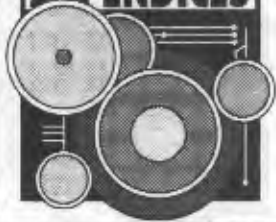

104

ELF STREET SAMURAI

"There are some who claim that elves do not make good warriors. I am one who proves them wrong. Cross me and learn the true definition of elven wrath.

"The streets are as much my home as they are yours. Do not make the foolish mistake of assuming my abilities are limited to things growing green and lush in the forest. I prefer darker tones.

"My price is that which I have stated, and I stand by my reputation. If that is not enough, then perhaps you should seek the services of another. If the price is agreeable, then I suggest we discuss details. Time grows short."

Commentary: Do not make the mistake of stereotyping the elf street samurai. He may be cunning and subtle, but his physical ability makes him an even match for anyone on the streets.

Attributes

Body: 3
Quickness: 7 (8)
Strength: 3 (4)
Charisma: 2
Intelligence: 3
Willpower: 2
Essence: .6
Reaction: 5 (9)

Initiative: 9 + 3D6

Dice Pools

Combat: 6

Cyberware

(3) Chipjacks
Muscle Replacement (1)
Skillwire (3)
Smartlink
Wired Reflexes (2)

Contacts

Choose (3) Contacts

Gear

Ares Predator (with internal smartlink, 100 rounds each regular and APDS ammo)
DocWagon Contract (Platinum)
FN HAR (with internal smartlink, gas-vent (2) recoil reduction, 300 rounds each regular and explosive ammo)
Ingram Smartgun (with internal smartlink, 300 rounds regular ammo)
Lined Coat (4/2)
Middle Lifestyle (2 months prepaid)
Skillsofts
Car: 3
Demolition: 3
Japanese: 3
Rotorcraft: 3
Throwing Weapons: 3
(2) Stimulant Patches: 6

Starting Cash: 15,200¥

Notes: An elf street samurai has natural low-light vision.

Skills

Bike: 2
Etiquette (Street): 3
Firearms: 6
Stealth: 6
Throwing Weapons: 1
Unarmed Combat: 6



INFORMATION

SALESPERSON

SECTION

105

INFORMATION



SALESPERSON

SECTION



APPENDICES



ORK STREET SAMURAI

"You seem surprised. Is it my clothing? The way I speak? Or is it the fact that I am samurai?"

"If you intend to work the street, you cannot be surprised. Surprise means weakness, and weakness spells death. You must learn to expect everything.

"And I expect you will find the conditions for my employment agreeable. Believe me, there is no one better suited than me. I am perfect for your shadowrun.

"Dere ain't nobody better who knows da streets like I's do. There, does that sound more orkish for you?"

Commentary: Need to cut a deal with orks? The ork street samurai is your man. Need to cut a deal with anyone? The ork street samurai is still your man.

Don't let the charming good looks or phony accent fool you. Beneath the smiling face is a street veteran, a tough professional who's lived through more trouble than you want to know. That's why he's smiling.

Because of his lack of cyberware, the ork street samurai has a lighter touch than you would expect. He prefers more "organic" solutions.

Attributes

Body: 9
Quickness: 4
Strength: 6
Charisma: 1
Intelligence: 4
Willpower: 3
Essence: 5.2
Reaction: 4

Initiative: 4 + 1D6

Dice Pools

Combat: 5

Cyberware

Retractable Spurs
Smartlink

Contacts

Choose (3) Contacts

Gear

AK-97 (with external smartlink, 100 rounds regular ammo)
Ares Predator (with 100 rounds regular ammo)
Armored Jacket (5/3)
DocWagon Contract (Gold)
Low Lifestyle

Starting Cash: 12,320¥

Notes: The ork street samurai has natural low-light vision.

Skills

Armed Combat: 5
Etiquette (Street): 3
Firearms: 6
Stealth: 2
Unarmed Combat: 4

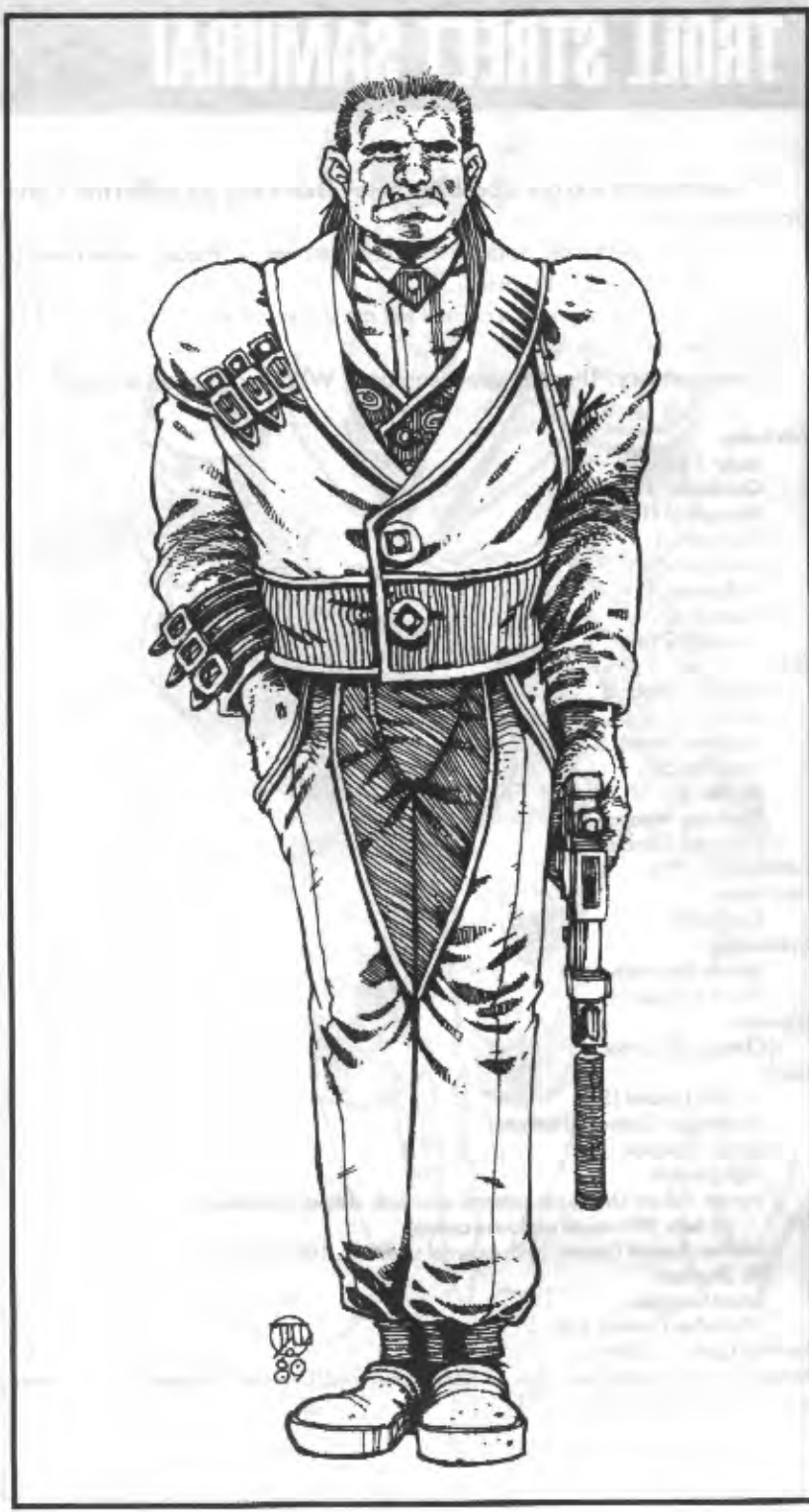

INFORMATION

SALESPERSON

SECTION

INFORMATION



SALESPERSON



SECTION



APPENDICES

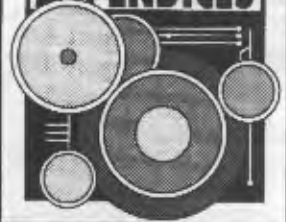

TROLL STREET SAMURAI

"I understand you got a problem here? That's why ya called me, right? So, what is it?"

"Point him out to me, and yer troubles are over. If "mean" were a name on the streets, it would be me.

"I can handle any job. You just tell me what yer willin' to pay, and I'll let ya know if I'm insulted."

Commentary: The troll street samurai. What more need we say?

Attributes

Body: 7 (8)
 Quickness: 3 (7)
 Strength: 6 (10)
 Charisma: 1
 Intelligence: 2
 Willpower: 1
 Essence: .0
 Reaction: 2 (4)

Skills

Armed Combat: 5
 Bike: 3
 Etiquette (Street): 3
 Firearms: 5
 Stealth: 3
 Throwing Weapons: 5
 Unarmed Combat: 6

Initiative: 4 + 2D6

Dice Pools

Combat: 5

Cyberware

Muscle Replacement: 4
 Wired Reflexes: 1

Contacts

Choose (3) Contacts

Gear

Armored Jacket (5/3)
 DocWagon Contract (Platinum)
 Harley Scorpion
 High Lifestyle
 Ingram Valiant LMG (with external smartlink, deluxe gyro-mount, (2) belts 200-round explosive ammo)
 Panther Assault Cannon (with external smartlink, 100 rounds regular ammo)
 (8) Shuriken
 Smart Goggles
 Wallacher Combat Axe

Starting Cash: 10,300¥

Notes: The troll street samurai has +1 Reach for Armed/Unarmed Combat, natural thermographic vision, Dermal Armor (1).



INFORMATION

SALESPERSON

SECTION

109

WEAPONS

MELEE WEAPONS

| | Concealability | Reach | Damage | Weight | Availability | Cost | Street Index |
|----------------------|----------------|-------|------------|--------|--------------|---------|--------------|
| Edged Weapons | | | | | | | |
| Ares Monosword | 3 | 1 | (STR + 3)M | 2 | 4/24 hrs | 1,000¥ | 1 |
| Centurion Laser Axe | 2 | 1 | (STR)S | 5.2 | 6/48 hrs | 3,500¥ | .5 |
| Combat Axe | 2 | 2 | (STR)S | 2.0 | 3/24hrs | 750 | 2 |
| Thrusting Point | NA | 0 | (STR + 2)L | NA | NA | NA | NA |
| Survival Knife | 6 | 0 | (STR + 2)L | .75 | 3/6 hrs | 450¥ | 1 |
| Clubs | | | | | | | |
| AZ-150 Stun Baton | 5 | 1 | 8S Stun | 1 | 3/36 hrs | 1,500¥ | 2 |
| Other | | | | | | | |
| Forearm Snap Blades | 7 | 0 | (STR)M | 1.5 | 4/48 hrs | 850¥ | 2 |
| Improved Hand Blades | NA | 0 | (STR + 2)L | 0 | 6/72 hrs | +8,500¥ | 1 |
| Shock Glove | 9 | 0 | 7S Stun | .5 | 5/48 hrs | 950¥ | 2 |

PROJECTILE WEAPONS

| | Concealability | Str. Min | Damage | Weight | Availability | Cost | Street Index |
|-----------------|----------------|----------|------------|--------|--------------|-----------------|--------------|
| Bows | | | | | | | |
| Ranger-X Bow | 2 | 2+ | (STR + 4)M | 1.5 | 5/36 hrs | 120¥ x Str. Min | 2 |
| Ranger-X Arrows | 4 | NA | As bow | .08 | 4/36 hrs | 18¥ | 1 |

FIREARMS

| | Conceal | Ammo | Mode | Damage | Weight | Availability | Cost | Street Index |
|------------------------|---------|-------|--------|--------|--------|--------------|------|--------------|
| PISTOLS | | | | | | | | |
| Hold-Out | | | | | | | | |
| Tiffani Self-Defender | 8 | 4(c) | SS | 4L | .5 | 2/12 hrs | 450¥ | .75 |
| Light | | | | | | | | |
| Ares Light Fire 70 | 5 | 16(c) | SA | 6L | 1 | 3/12 hrs | 475¥ | .8 |
| Beretta 200ST | 4 | 26(c) | SA/BF* | 6L | 2 | 5/24 hrs | 750¥ | 1.5 |
| Ceska vz/120 | 7 | 18(c) | SA | 6L | 1 | 3/12 hrs | 500¥ | .8 |
| Seco LD-120 | 5 | 12(c) | SA | 6L | 1 | 3/12 hrs | 400¥ | .8 |
| Machine Pistols | | | | | | | | |
| Ares Crusader MP | 6 | 40(c) | SA/BF | 6L | 3.25 | 5/36 hrs | 950¥ | 2 |
| Ceska Black Scorpion | 5 | 35(c) | SA/BF | 6L | 3 | 5/36 hrs | 850¥ | 2 |
| Heavy Pistols | | | | | | | | |
| Ares Predator II | 4 | 15(c) | SA | 9M | 2.5 | 4/24 hrs | 550¥ | .5 |
| Browning Ultra-Power | 6 | 10(c) | SA | 9M | 2.25 | 4/24 hrs | 525¥ | 1.5 |
| Colt Manhunter | 5 | 16(c) | SA | 9M | 2.5 | 4/24 hrs | 425¥ | 1 |

*This weapon can fire one (1) burst-fire per action as a Complex Action

SPECIAL WEAPONS

| | Conceal | Ammo | Mode | Damage | Weight | Availability | Cost | Street |
|------------------------|---------|-------|----------|----------|--------|--------------|----------|--------|
| Narcoject Pistol | 7 | 5(c) | SA | As toxin | 1.5 | 8/2 days | 800¥ | 2 |
| Narcoject Rifle | 4 | 10(c) | SA | As toxin | 3.25 | 8/2 days | 1,700¥ | 2 |
| Net Gun, Normal | 4 | 4(b) | SA | Special | 4 | 8/36 hrs | 750¥ | 2 |
| Large | 3 | 4(b) | SA | Special | 4.5 | 8/36 hrs | 1,150¥ | 2 |
| Submachine Guns | | | | | | | | |
| Berretta Model 70 | 3 | 35(c) | BF/FA | 6M | 3.75 | 5/3 days | 900¥ | 1 |
| Heckler & Koch MP-5TX | 5 | 20(c) | SA/BF/FA | 6M | 3.25 | 5/36 hrs | 850¥ | 1 |
| Ingram Smartgun | 5 | 32(c) | BF/FA | 7M | 3 | 4/24 hrs | 950¥ | 1 |
| Sandler TMP | 4 | 20(c) | BF/FA | 6M | 3.25 | 5/36 hrs | 500¥ | 1 |
| SCK Model 100 | 4 | 30(c) | SA/BF | 7M | 4.5 | 5/36 hrs | 1,000¥ | 1 |
| Steyr AUG-CSL (SMG)* | 5 | 40(c) | SA/BF | 6M | 3.5 | 10/4 days | See note | 3 |

Rifles

| | | | | | | | | |
|--------------------------|----------|----|--|--------------|-----|------|--------|--|
| AK-97 | Assault | 3 | | 22 (Clip) | 5M3 | 4.5 | 700¥ | |
| AK-98 | Assault | NA | | 22 (Clip) | 5M3 | 6 | 2,500¥ | |
| Coll M22a2 Assault Rifle | Assault | 3 | | 40 (Clip) | 5M3 | 4.75 | 1,600¥ | |
| FN HAR | Assault | 2 | | 20 (Clip) | 5M3 | 4.5 | 1,200¥ | |
| Heckler & Koch G12A3z | Assault | 2 | | 32 (Clip) | 5M3 | 5.25 | 2,200¥ | |
| Sarnopal vz88V | Assault | 2 | | 35 (Clip) | 5M3 | 5.5 | 1,800¥ | |
| Steyr AUG-CSL | Assault | 2 | | 40 (Clip) | 5M3 | 4 | | |
| Remington 750 | Sporting | 3 | | 5 (Magazine) | 5S2 | 3 | 600¥ | |
| Remington 950 | Sporting | 2 | | 5 (Magazine) | 6S2 | 4 | 800¥ | |
| Ruger 100 Sporting Rifle | Sporting | 2 | | 5 (Magazine) | 5S2 | 3.75 | 1,300¥ | |
| Steyr AUG-CSL Carbine | Sporting | 3 | | 40 (Clip) | 5M3 | 3.75 | | |
| Ranger Arms SM-3 | Sniper | NA | | 8 (Magazine) | 6S2 | 4 | 4,000¥ | |
| Walther MA 2100 | Sniper | NA | | 8 (Magazine) | 6S2 | 4.5 | 8,500¥ | |
| Enfield AS7 | Shotgun | 3 | | 10 (Clip) | 4M3 | 4 | 1,000¥ | |
| Defiance T-250 | Shotgun | 4 | | 5 (Magazine) | 3M3 | 3 | 500¥ | |
| Mossberg CMDT | Shotgun | 2 | | 8 (Clip) | 5M3 | 4.25 | 1,400¥ | |

RIFLES

| | Conceal | Ammo | Mode | Damage | Weight | Availability | Cost | Street Index |
|------------------------|---------|-------|----------|--------|--------|--------------|-----------------|--------------|
| Sport Rifles | | | | | | | | |
| Ruger 100 | 2 | 5(m) | SA | 7S | 3.75 | 3/24 hrs | 1,300¥ | 1 |
| Steyr AUG-CSL Carbine* | 3 | 40(c) | SA/BF | 7S | 3.75 | 10/4 days | See note | 3 |
| Sniper Rifles | | | | | | | | |
| Walther MA-2100 | — | 10(m) | SA | 14S | 4.5 | 12/7 days | 6,500¥ | 4 |
| Shotguns | | | | | | | | |
| Mossberg CMTD | 2 | 8(c) | SA/BF | 9S | 4.25 | 8/8 days | 1,400¥ | 1 |
| Mossberg 5M-CMTD | 2 | 8(c) | SA/BF | 9S | 4.5 | 12/8 days | 1,900¥ | 2 |
| Assault Rifles | | | | | | | | |
| Colt M22A2 | 3 | 40(c) | SA/BF/FA | 8M | 4.75 | 4/3 days | 1,600¥ | 2 |
| H&K G12A3z | 2 | 32(c) | SA/BF/FA | 8M | 5.25 | 8/4 days | 2,200¥ | 3 |
| Samopal vz 88V | 2 | 35(c) | SA/BF/FA | 8M | 5.5 | 5/36 hrs | 1,800¥ | 2 |
| Steyr AUG-CSL AR* | 2 | 40(c) | SA/BF/FA | 8M | 4 | 10/4 days | See note | 3 |

LIGHT MACHINE GUNS

| | | | | | | | | |
|-----------------------|---|---------------|----------|----|-----|------------|-----------------|---|
| Ares MP-LMG | — | Belt 50(c) | BF/FA | 7S | 7.5 | 6/5 days | 2,200¥ | 2 |
| GE Vindicator Minigun | — | Belt 50(c) | FA | 7S | 15 | 24/14 days | 2,500¥ | 2 |
| Steyr AUG-CSL LMG* | — | 40(c) | SA/BF/FA | 8M | 5.5 | 10/4 days | See note | 3 |

*The entire Steyr AUG-CSL package comes with all listed accessories and costs 4,500¥.

LASER WEAPONS

| | | | | | | | | |
|---------------|---|-----------|----|-----|----|----|--------------|----|
| Ares MP Laser | — | 20 (Pack) | SA | 15M | 30 | NA | 2.5 million¥ | NA |
|---------------|---|-----------|----|-----|----|----|--------------|----|

HEAVY WEAPONS

| | | | | | | | | |
|------------------------|---|------------------|----|-------------|------|------------|--------|---|
| FN MAG-5 MMG | — | Belt 50 (Box) | FA | 9S | 9.5 | 18/14 days | 3,200¥ | 3 |
| Stoner-Ares M107 | — | Belt 50 (Box) | FA | 10S | 12.5 | 18/14 days | 5,200¥ | 3 |
| Panther Assault Cannon | — | 22(c) | SS | 18D Belt | 18 | 16/14 days | ,200¥ | 2 |

ROCKET/MISSILES TABLE

| Type | Intelligence | Damage | Weight | Availability | Cost | Street Index |
|----------------------|--------------|--------|--------|--------------|--------|--------------|
| Missiles | | | | | | |
| Surface to Air (SAM) | 4 | 13 D | 1.5 | 18/21 days | 2,500¥ | 4 |

AMMUNITION, per 10 shots

| | Concealability* | Damage | Weight | Availability** | Cost | Street Index |
|------|-----------------|-----------|--------|----------------|------|--------------|
| APDS | 8 | see rules | .25 | 14/14 days | 70¥ | 4 |

*-1 Concealability per extra 10 rounds of ammo

**Belted ammo: add rounds/100 to Availability

FIREARM AND WEAPON ACCESSORIES

| | Mount | Concealability | Rating | Weight | Availability | Cost | Street Index |
|--------------------------------------|--------|----------------|--------|--------|--------------|--------|--------------|
| Bow Accessory Mount | NA | -1 | — | .1 | 2/24 hrs | 100¥ | .9 |
| Rangefinder | Under | — | — | .1 | 2/24 hrs | 150¥ | .8 |
| Grenade Link | — | — | — | .1 | 8/48 hrs | 750¥ | 2 |
| Recoil Compensators and Gyros | | | | | | | |
| Imp. Gas Vent II | Barrel | — | 2 | .25 | 2/24 hrs | 550¥ | .9 |
| Imp. Gas Vent III | Barrel | -1 | 3 | .5 | 2/24 hrs | 800¥ | .9 |
| Imp. Gas Vent IV | Barrel | -2 | 4 | .75 | 2/24 hrs | 1,000¥ | 1 |
| Imp. Gyro Mount | Under | -6 | 5 | 5 | 6/48 hrs | 3,500¥ | 1 |
| Deluxe Imp. Gyro Mount | Under | -7 | 7 | 7 | 6/48 hrs | 7,800¥ | 1 |
| Ultrasound Sight | Top | -2 | — | .25 | 8/4 days | 1,300¥ | .8 |
| Ultrasound Goggles | NA | — | — | — | 3/36 hrs | 1,100¥ | 1 |

EXPLOSIVES

| | Concealability | Damage | Weight | Availability | Cost | Street Index |
|-----------------|----------------|---------|--------|--------------|------|--------------|
| Grenades | | | | | | |
| Flash | 6 | Special | .25 | 4/48 hrs | 40¥ | 1 |
| Flash-Pak | 12 | Special | .2 | 3/36 hrs | 250¥ | 1 |

CLOTHING AND ARMOR

| | Concealability | Ballistic | Impact | Weight | Availability | Cost | Street Index |
|--------------------------------|----------------|-----------|--------|-----------|--------------|---------|--------------|
| Forearm Guards | 12 | 0 | 1 | .2 | 5/36 hrs | 250¥ | .75 |
| Riot Shield, Small | — | 1 | | 2 | 8/14 days | 1,500¥ | 2 |
| Secure Clothing | 12 | 3 | 0 | 1.5 | 3/36 hrs | 450¥ | .9 |
| Secure Jacket | 9 | 5 | 3 | 3 | 4/36 hrs | 850¥ | .8 |
| Secure Vest | 15 | 2 | 1 | .75 | 3/36 hrs | 175¥ | .9 |
| Secure Ultra-Vest | 14 | 3 | 2 | 2.5 | 3/36 hrs | 350¥ | .9 |
| Secure Long Coat | 10 | 4 | 2 | 2 | 3/24 hrs | 650¥ | .9 |
| Form-Fitting Body Armor | | | | | | | |
| Level 1 | — | 2 | 0 | .75 | 3/48 hrs | 150¥ | 1 |
| Level 2 | 15 | 3 | 1 | 1.25 | 4/48 hrs | 250¥ | 1 |
| Level 3 | 12 | 4 | 1 | 1.75 | 4/48 hrs | 500¥ | 1 |
| Security Armor | | | | | | | |
| Light Security | NA | 6 | 4 | 9 + Body | 12/10 days | 7,500¥ | 2 |
| Medium Security | NA | 6 | 5 | 11 + Body | 14/10 days | 9,000¥ | 2.5 |
| Heavy Security | NA | 7 | 5 | 13 + Body | 16/14 days | 12,000¥ | 3 |
| Security Helmet | NA | 1 | 2 | — | 12/14 days | 250¥ | 2 |

CYBERTECH

| | Essence Cost | Availability | Cost | Street Index |
|----------------------------------|--------------|--------------|------------------|--------------|
| HEADWARE | | | | |
| Communications | | | | |
| CommLink II | .3 | 2/48 hrs | 8,000¥ | 1 |
| CommLink IV | .3 | 3/48 hrs | 18,000¥ | 1.25 |
| CommLink VIII | .3 | 4/48 hrs | 40,000¥ | 1.5 |
| CommLink X | .3 | 5/48 hrs | 60,000¥ | 1.75 |
| Crypto Circuit HD | | | | |
| Level 1-4 | .1 | 6/36 hrs | Level x 10,000¥ | 1 |
| Level 5-7 | .1 | 6/36 hrs | Level x 20,000¥ | 1.25 |
| Level 8-9 | .1 | 8/36 hrs | Level x 30,000¥ | 1.5 |
| Level 10 | .1 | 9/36 hrs | 500,000¥ | 2 |
| Scramble Breaker HD | | | | |
| Level 1-4 | .2 | 6/48 hrs | Level x 20,000¥ | 1.5 |
| Level 5-7 | .2 | 8/48 hrs | Level x 40,000¥ | 1.75 |
| Level 8 | .2 | 10/48 hrs | 600,000¥ | 1.75 |
| Ears | | | | |
| Hearing Amplification | .2 | 4/48 hrs | 3,500¥ | 1.25 |
| Select Sound Filter (Levels 1-5) | .2 | 6/48 hrs | Level x 10,000¥ | 1.25 |
| Eyes | | | | |
| Vision Magnification | | | | |
| Optical 1 | .2 | 4/48 hrs | 2,500¥ | 1 |
| Optical 2 | .2 | 4/48 hrs | 4,000¥ | 1 |
| Optical 3 | .2 | 5/48 hrs | 6,000¥ | 1 |
| Electronic 1 | .1 | 5/48 hrs | 3,500¥ | 1 |
| Electronic 2 | .1 | 5/48 hrs | 7,500¥ | 1 |
| Electronic 3 | .1 | 8/48 hrs | 11,000¥ | 1 |
| Rangefinder | .1 | 8/48 hrs | 2,000¥ | 1.5 |
| INTERNALS | | | | |
| Internal Voice Mask | .1 | 6/48 hrs | 7,000¥ | 1 |
| Sense Link | .2 | 2/5 days | 300,000¥ | 1 |
| Internal Transmitter | .6 | 3/5 days | 80,000¥ | 1.5 |
| Video Link | .5 | 4/48 hrs | 22,000¥ | 1 |
| Internal Transmitter | .4 | 6/48 hrs | 4,500¥ | 1 |
| BODYWARE | | | | |
| Cyberguns | | | | |
| Hold-Out Pistol | — | 8/7 days | 250¥ | 2 |
| Light Pistol | — | 8/7 days | 650¥ | 2 |
| Machine Pistol | — | 8/7 days | 900¥ | 2 |
| Submachine Gun | — | 8/7 days | 1,800¥ | 2 |
| Heavy Pistol | — | 8/7 days | 800¥ | 2 |
| Shotgun | — | 8/7 days | 1,200¥ | 2 |
| Skill Hardwires | | | | |
| Level 1-4 | Level x .2 | 6/10 days | Level x 5,000¥ | 1 |
| Level 5-8 | Level x .25 | 12/14 days | Level x 50,000¥ | 1.5 |
| Level 9-10 | Level x .3 | 12/14 days | Level x 500,000¥ | 1.5 |
| Boosted Reflexes | | | | |
| Level 1 | .5 | 3/24 hrs | 15,000¥ | 1 |
| Level 2 | 1.25 | 3/24 hrs | 40,000¥ | 1.25 |
| Level 3 | 2.8 | 3/24 hrs | 90,000¥ | 1.5 |

SHADOWRUN

S·E·C·O·N·D E·D·I·T·I·O·N

| | | |
|-------|-----|-------------|
| NAME | | RACE |
| SEX | AGE | DESCRIPTION |
| NOTES | | |

STREET SAMURAI RECORD SHEET

ATTRIBUTES

| | | |
|-----------------|--------|------------|
| Body | RATING | |
| Quickness | | REACTION |
| Strength | | |
| Charisma | | |
| Intelligence | | INITIATIVE |
| Willpower | | |
| Essence (Magic) | | |

CONDITION MONITOR

| | | | | |
|--------------------------|-------------------|--------------------|--------------------|--------------------|
| | LIGHT STUN | MODERATE STUN | SERIOUS STUN | DEADLY STUN |
| STUN | +1 TN# 1 Init. | +2 TN# -2 Init. | +3 TN# -3 Init. | Unc. |
| PHYSICAL | +1 TN# 1 Init. | +2 TN# -2 Init. | +3 TN# -3 Init. | Unc. maybe dead |
| | LIGHT WOUND | MODERATE WOUND | SERIOUS WOUND | DEADLY WOUND |
| PHYSICAL DAMAGE OVERFLOW | | | | |

KARMA

KARMA POOL

GOOD KARMA

SKILLS

| NAME | RATING | NAME | RATING | NAME | RATING |
|------|--------|------|--------|------|--------|
| | | | | | |
| | | | | | |
| | | | | | |
| | | | | | |
| | | | | | |
| | | | | | |
| | | | | | |
| | | | | | |
| | | | | | |
| | | | | | |

DICE POOLS

COMBAT POOL

POOL

POOL

POOL

ARMOR/GEAR

| TYPE | RATING |
|------|--------|
| | |
| | |
| | |
| | |
| | |
| | |
| | |
| | |

CYBERWARE

| TYPE | RATING | TYPE | RATING | TYPE | RATING | TYPE | RATING |
|------|--------|------|--------|------|--------|------|--------|
| | | | | | | | |
| | | | | | | | |
| | | | | | | | |
| | | | | | | | |
| | | | | | | | |
| | | | | | | | |
| | | | | | | | |
| | | | | | | | |

WEAPONS

| NAME | TYPE | CONCEALABILITY | REACH | MODE | SHORT | MEDIUM | LONG | EXTREME | AMMO | DAMAGE | MODIFIERS |
|------|------|----------------|-------|------|-------|--------|------|---------|------|--------|-----------|
| | | | | | | | | | | | |
| | | | | | | | | | | | |
| | | | | | | | | | | | |
| | | | | | | | | | | | |
| | | | | | | | | | | | |
| | | | | | | | | | | | |
| | | | | | | | | | | | |
| | | | | | | | | | | | |

WEAPONS

MELEE WEAPONS

| | Concealability | Reach | Damage | Weight | Availability | Cost | Street Index |
|----------------------|----------------|-------|------------|--------|--------------|---------|--------------|
| Edged Weapons | | | | | | | |
| Ares Monosword | 3 | 1 | (STR + 3)M | 2 | 4/24 hrs | 1,000¥ | 1 |
| Centurion Laser Axe | 2 | 1 | (STR)S | 5.2 | 6/48 hrs | 3,500¥ | .5 |
| Combat Axe | 2 | 2 | (STR)S | 2.0 | 3/24hrs | 750 | 2 |
| Thrusting Point | NA | 0 | (STR + 2)L | NA | NA | NA | NA |
| Survival Knife | 6 | 0 | (STR + 2)L | .75 | 3/6 hrs | 450¥ | 1 |
| Clubs | | | | | | | |
| AZ-150 Stun Baton | 5 | 1 | 8S Stun | 1 | 3/36 hrs | 1,500¥ | 2 |
| Other | | | | | | | |
| Forearm Snap Blades | 7 | 0 | (STR)M | 1.5 | 4/48 hrs | 850¥ | 2 |
| Improved Hand Blades | NA | 0 | (STR + 2)L | 0 | 6/72 hrs | +8,500¥ | 1 |
| Shock Glove | 9 | 0 | 7S Stun | .5 | 5/48 hrs | 950¥ | 2 |

PROJECTILE WEAPONS

| | Concealability | Str. Min | Damage | Weight | Availability | Cost | Street Index |
|-----------------|----------------|----------|------------|--------|--------------|-----------------|--------------|
| Bows | | | | | | | |
| Ranger-X Bow | 2 | 2+ | (STR + 4)M | 1.5 | 5/36 hrs | 120¥ x Str. Min | 2 |
| Ranger-X Arrows | 4 | NA | As bow | .08 | 4/36 hrs | 18¥ | 1 |

FIREARMS

| | Conceal | Ammo | Mode | Damage | Weight | Availability | Cost | Street Index |
|------------------------|---------|-------|--------|--------|--------|--------------|------|--------------|
| PISTOLS | | | | | | | | |
| Hold-Out | | | | | | | | |
| Tiffani Self-Defender | 8 | 4(c) | SS | 4L | .5 | 2/12 hrs | 450¥ | .75 |
| Light | | | | | | | | |
| Ares Light Fire 70 | 5 | 16(c) | SA | 6L | 1 | 3/12 hrs | 475¥ | .8 |
| Beretta 200ST | 4 | 26(c) | SA/BF* | 6L | 2 | 5/24 hrs | 750¥ | 1.5 |
| Ceska vz/120 | 7 | 18(c) | SA | 6L | 1 | 3/12 hrs | 500¥ | .8 |
| Seco LD-120 | 5 | 12(c) | SA | 6L | 1 | 3/12 hrs | 400¥ | .8 |
| Machine Pistols | | | | | | | | |
| Ares Crusader MP | 6 | 40(c) | SA/BF | 6L | 3.25 | 5/36 hrs | 950¥ | 2 |
| Ceska Black Scorpion | 5 | 35(c) | SA/BF | 6L | 3 | 5/36 hrs | 850¥ | 2 |
| Heavy Pistols | | | | | | | | |
| Ares Predator II | 4 | 15(c) | SA | 9M | 2.5 | 4/24 hrs | 550¥ | .5 |
| Browning Ultra-Power | 6 | 10(c) | SA | 9M | 2.25 | 4/24 hrs | 525¥ | 1.5 |
| Colt Manhunter | 5 | 16(c) | SA | 9M | 2.5 | 4/24 hrs | 425¥ | 1 |

*This weapon can fire one (1) burst-fire per action as a Complex Action

SPECIAL WEAPONS

| | Conceal | Ammo | Mode | Damage | Weight | Availability | Cost | Street |
|------------------------|---------|-------|----------|----------|--------|--------------|----------|--------|
| Narcoject Pistol | 7 | 5(c) | SA | As toxin | 1.5 | 8/2 days | 800¥ | 2 |
| Narcoject Rifle | 4 | 10(c) | SA | As toxin | 3.25 | 8/2 days | 1,700¥ | 2 |
| Net Gun, Normal | 4 | 4(b) | SA | Special | 4 | 8/36 hrs | 750¥ | 2 |
| Large | 3 | 4(b) | SA | Special | 4.5 | 8/36 hrs | 1,150¥ | 2 |
| Submachine Guns | | | | | | | | |
| Berretta Model 70 | 3 | 35(c) | BF/FA | 6M | 3.75 | 5/3 days | 900¥ | 1 |
| Heckler & Koch MP-5TX | 5 | 20(c) | SA/BF/FA | 6M | 3.25 | 5/36 hrs | 850¥ | 1 |
| Ingram Smartgun | 5 | 32(c) | BF/FA | 7M | 3 | 4/24 hrs | 950¥ | 1 |
| Sandler TMP | 4 | 20(c) | BF/FA | 6M | 3.25 | 5/36 hrs | 500¥ | 1 |
| SCK Model 100 | 4 | 30(c) | SA/BF | 7M | 4.5 | 5/36 hrs | 1,000¥ | 1 |
| Steyr AUG-CSL (SMG)* | 5 | 40(c) | SA/BF | 6M | 3.5 | 10/4 days | See note | 3 |

Rifles

| | | | | | | | | |
|--------------------------|----------|----|--|--------------|-----|------|--------|--|
| AK-97 | Assault | 3 | | 22 (Clip) | 5M3 | 4.5 | 700¥ | |
| AK-98 | Assault | NA | | 22 (Clip) | 5M3 | 6 | 2,500¥ | |
| Coll M22a2 Assault Rifle | Assault | 3 | | 40 (Clip) | 5M3 | 4.75 | 1,600¥ | |
| FN HAR | Assault | 2 | | 20 (Clip) | 5M3 | 4.5 | 1,200¥ | |
| Heckler & Koch G12A3z | Assault | 2 | | 32 (Clip) | 5M3 | 5.25 | 2,200¥ | |
| Sarnopal vz88V | Assault | 2 | | 35 (Clip) | 5M3 | 5.5 | 1,800¥ | |
| Steyr AUG-CSL | Assault | 2 | | 40 (Clip) | 5M3 | 4 | | |
| Remington 750 | Sporting | 3 | | 5 (Magazine) | 5S2 | 3 | 600¥ | |
| Remington 950 | Sporting | 2 | | 5 (Magazine) | 6S2 | 4 | 800¥ | |
| Ruger 100 Sporting Rifle | Sporting | 2 | | 5 (Magazine) | 5S2 | 3.75 | 1,300¥ | |
| Steyr AUG-CSL Carbine | Sporting | 3 | | 40 (Clip) | 5M3 | 3.75 | | |
| Ranger Arms SM-3 | Sniper | NA | | 8 (Magazine) | 6S2 | 4 | 4,000¥ | |
| Walther MA 2100 | Sniper | NA | | 8 (Magazine) | 6S2 | 4.5 | 8,500¥ | |
| Enfield AS7 | Shotgun | 3 | | 10 (Clip) | 4M3 | 4 | 1,000¥ | |
| Defiance T-250 | Shotgun | 4 | | 5 (Magazine) | 3M3 | 3 | 500¥ | |
| Mossberg CMDT | Shotgun | 2 | | 8 (Clip) | 5M3 | 4.25 | 1,400¥ | |

RIFLES

| | Conceal | Ammo | Mode | Damage | Weight | Availability | Cost | Street Index |
|------------------------|---------|-------|----------|--------|--------|--------------|-----------------|--------------|
| Sport Rifles | | | | | | | | |
| Ruger 100 | 2 | 5(m) | SA | 7S | 3.75 | 3/24 hrs | 1,300¥ | 1 |
| Steyr AUG-CSL Carbine* | 3 | 40(c) | SA/BF | 7S | 3.75 | 10/4 days | See note | 3 |
| Sniper Rifles | | | | | | | | |
| Walther MA-2100 | — | 10(m) | SA | 14S | 4.5 | 12/7 days | 6,500¥ | 4 |
| Shotguns | | | | | | | | |
| Mossberg CMTD | 2 | 8(c) | SA/BF | 9S | 4.25 | 8/8 days | 1,400¥ | 1 |
| Mossberg 5M-CMTD | 2 | 8(c) | SA/BF | 9S | 4.5 | 12/8 days | 1,900¥ | 2 |
| Assault Rifles | | | | | | | | |
| Colt M22A2 | 3 | 40(c) | SA/BF/FA | 8M | 4.75 | 4/3 days | 1,600¥ | 2 |
| H&K G12A3z | 2 | 32(c) | SA/BF/FA | 8M | 5.25 | 8/4 days | 2,200¥ | 3 |
| Samopal vz 88V | 2 | 35(c) | SA/BF/FA | 8M | 5.5 | 5/36 hrs | 1,800¥ | 2 |
| Steyr AUG-CSL AR* | 2 | 40(c) | SA/BF/FA | 8M | 4 | 10/4 days | See note | 3 |

LIGHT MACHINE GUNS

| | | | | | | | | |
|-----------------------|---|---------------|----------|----|-----|------------|-----------------|---|
| Ares MP-LMG | — | Belt 50(c) | BF/FA | 7S | 7.5 | 6/5 days | 2,200¥ | 2 |
| GE Vindicator Minigun | — | Belt 50(c) | FA | 7S | 15 | 24/14 days | 2,500¥ | 2 |
| Steyr AUG-CSL LMG* | — | 40(c) | SA/BF/FA | 8M | 5.5 | 10/4 days | See note | 3 |

*The entire Steyr AUG-CSL package comes with all listed accessories and costs 4,500¥.

LASER WEAPONS

| | | | | | | | | |
|---------------|---|-----------|----|-----|----|----|--------------|----|
| Ares MP Laser | — | 20 (Pack) | SA | 15M | 30 | NA | 2.5 million¥ | NA |
|---------------|---|-----------|----|-----|----|----|--------------|----|

HEAVY WEAPONS

| | | | | | | | | |
|------------------------|---|------------------|----|-------------|------|------------|--------|---|
| FN MAG-5 MMG | — | Belt 50 (Box) | FA | 9S | 9.5 | 18/14 days | 3,200¥ | 3 |
| Stoner-Ares M107 | — | Belt 50 (Box) | FA | 10S | 12.5 | 18/14 days | 5,200¥ | 3 |
| Panther Assault Cannon | — | 22(c) | SS | 18D Belt | 18 | 16/14 days | ,200¥ | 2 |

ROCKET/MISSILES TABLE

| Type | Intelligence | Damage | Weight | Availability | Cost | Street Index |
|----------------------|--------------|--------|--------|--------------|--------|--------------|
| Missiles | | | | | | |
| Surface to Air (SAM) | 4 | 13 D | 1.5 | 18/21 days | 2,500¥ | 4 |

AMMUNITION, per 10 shots

| | Concealability* | Damage | Weight | Availability** | Cost | Street Index |
|------|-----------------|-----------|--------|----------------|------|--------------|
| APDS | 8 | see rules | .25 | 14/14 days | 70¥ | 4 |

*-1 Concealability per extra 10 rounds of ammo

**Belted ammo: add rounds/100 to Availability

FIREARM AND WEAPON ACCESSORIES

| | Mount | Concealability | Rating | Weight | Availability | Cost | Street Index |
|--------------------------------------|--------|----------------|--------|--------|--------------|--------|--------------|
| Bow Accessory Mount | NA | -1 | — | .1 | 2/24 hrs | 100¥ | .9 |
| Rangefinder | Under | — | — | .1 | 2/24 hrs | 150¥ | .8 |
| Grenade Link | — | — | — | .1 | 8/48 hrs | 750¥ | 2 |
| Recoil Compensators and Gyros | | | | | | | |
| Imp. Gas Vent II | Barrel | — | 2 | .25 | 2/24 hrs | 550¥ | .9 |
| Imp. Gas Vent III | Barrel | -1 | 3 | .5 | 2/24 hrs | 800¥ | .9 |
| Imp. Gas Vent IV | Barrel | -2 | 4 | .75 | 2/24 hrs | 1,000¥ | 1 |
| Imp. Gyro Mount | Under | -6 | 5 | 5 | 6/48 hrs | 3,500¥ | 1 |
| Deluxe Imp. Gyro Mount | Under | -7 | 7 | 7 | 6/48 hrs | 7,800¥ | 1 |
| Ultrasound Sight | Top | -2 | — | .25 | 8/4 days | 1,300¥ | .8 |
| Ultrasound Goggles | NA | — | — | — | 3/36 hrs | 1,100¥ | 1 |

EXPLOSIVES

| | Concealability | Damage | Weight | Availability | Cost | Street Index |
|-----------------|----------------|---------|--------|--------------|------|--------------|
| Grenades | | | | | | |
| Flash | 6 | Special | .25 | 4/48 hrs | 40¥ | 1 |
| Flash-Pak | 12 | Special | .2 | 3/36 hrs | 250¥ | 1 |

CLOTHING AND ARMOR

| | Concealability | Ballistic | Impact | Weight | Availability | Cost | Street Index |
|--------------------------------|----------------|-----------|--------|-----------|--------------|---------|--------------|
| Forearm Guards | 12 | 0 | 1 | .2 | 5/36 hrs | 250¥ | .75 |
| Riot Shield, Small | — | 1 | | 2 | 8/14 days | 1,500¥ | 2 |
| Secure Clothing | 12 | 3 | 0 | 1.5 | 3/36 hrs | 450¥ | .9 |
| Secure Jacket | 9 | 5 | 3 | 3 | 4/36 hrs | 850¥ | .8 |
| Secure Vest | 15 | 2 | 1 | .75 | 3/36 hrs | 175¥ | .9 |
| Secure Ultra-Vest | 14 | 3 | 2 | 2.5 | 3/36 hrs | 350¥ | .9 |
| Secure Long Coat | 10 | 4 | 2 | 2 | 3/24 hrs | 650¥ | .9 |
| Form-Fitting Body Armor | | | | | | | |
| Level 1 | — | 2 | 0 | .75 | 3/48 hrs | 150¥ | 1 |
| Level 2 | 15 | 3 | 1 | 1.25 | 4/48 hrs | 250¥ | 1 |
| Level 3 | 12 | 4 | 1 | 1.75 | 4/48 hrs | 500¥ | 1 |
| Security Armor | | | | | | | |
| Light Security | NA | 6 | 4 | 9 + Body | 12/10 days | 7,500¥ | 2 |
| Medium Security | NA | 6 | 5 | 11 + Body | 14/10 days | 9,000¥ | 2.5 |
| Heavy Security | NA | 7 | 5 | 13 + Body | 16/14 days | 12,000¥ | 3 |
| Security Helmet | NA | 1 | 2 | — | 12/14 days | 250¥ | 2 |

CYBERTECH

| | Essence Cost | Availability | Cost | Street Index |
|----------------------------------|--------------|--------------|------------------|--------------|
| HEADWARE | | | | |
| Communications | | | | |
| CommLink II | .3 | 2/48 hrs | 8,000¥ | 1 |
| CommLink IV | .3 | 3/48 hrs | 18,000¥ | 1.25 |
| CommLink VIII | .3 | 4/48 hrs | 40,000¥ | 1.5 |
| CommLink X | .3 | 5/48 hrs | 60,000¥ | 1.75 |
| Crypto Circuit HD | | | | |
| Level 1-4 | .1 | 6/36 hrs | Level x 10,000¥ | 1 |
| Level 5-7 | .1 | 6/36 hrs | Level x 20,000¥ | 1.25 |
| Level 8-9 | .1 | 8/36 hrs | Level x 30,000¥ | 1.5 |
| Level 10 | .1 | 9/36 hrs | 500,000¥ | 2 |
| Scramble Breaker HD | | | | |
| Level 1-4 | .2 | 6/48 hrs | Level x 20,000¥ | 1.5 |
| Level 5-7 | .2 | 8/48 hrs | Level x 40,000¥ | 1.75 |
| Level 8 | .2 | 10/48 hrs | 600,000¥ | 1.75 |
| Ears | | | | |
| Hearing Amplification | .2 | 4/48 hrs | 3,500¥ | 1.25 |
| Select Sound Filter (Levels 1-5) | .2 | 6/48 hrs | Level x 10,000¥ | 1.25 |
| Eyes | | | | |
| Vision Magnification | | | | |
| Optical 1 | .2 | 4/48 hrs | 2,500¥ | 1 |
| Optical 2 | .2 | 4/48 hrs | 4,000¥ | 1 |
| Optical 3 | .2 | 5/48 hrs | 6,000¥ | 1 |
| Electronic 1 | .1 | 5/48 hrs | 3,500¥ | 1 |
| Electronic 2 | .1 | 5/48 hrs | 7,500¥ | 1 |
| Electronic 3 | .1 | 8/48 hrs | 11,000¥ | 1 |
| Rangefinder | .1 | 8/48 hrs | 2,000¥ | 1.5 |
| INTERNALS | | | | |
| Internal Voice Mask | .1 | 6/48 hrs | 7,000¥ | 1 |
| Sense Link | .2 | 2/5 days | 300,000¥ | 1 |
| Internal Transmitter | .6 | 3/5 days | 80,000¥ | 1.5 |
| Video Link | .5 | 4/48 hrs | 22,000¥ | 1 |
| Internal Transmitter | .4 | 6/48 hrs | 4,500¥ | 1 |
| BODYWARE | | | | |
| Cyberguns | | | | |
| Hold-Out Pistol | — | 8/7 days | 250¥ | 2 |
| Light Pistol | — | 8/7 days | 650¥ | 2 |
| Machine Pistol | — | 8/7 days | 900¥ | 2 |
| Submachine Gun | — | 8/7 days | 1,800¥ | 2 |
| Heavy Pistol | — | 8/7 days | 800¥ | 2 |
| Shotgun | — | 8/7 days | 1,200¥ | 2 |
| Skill Hardwires | | | | |
| Level 1-4 | Level x .2 | 6/10 days | Level x 5,000¥ | 1 |
| Level 5-8 | Level x .25 | 12/14 days | Level x 50,000¥ | 1.5 |
| Level 9-10 | Level x .3 | 12/14 days | Level x 500,000¥ | 1.5 |
| Boosted Reflexes | | | | |
| Level 1 | .5 | 3/24 hrs | 15,000¥ | 1 |
| Level 2 | 1.25 | 3/24 hrs | 40,000¥ | 1.25 |
| Level 3 | 2.8 | 3/24 hrs | 90,000¥ | 1.5 |